

Product Naming Rule v20251208

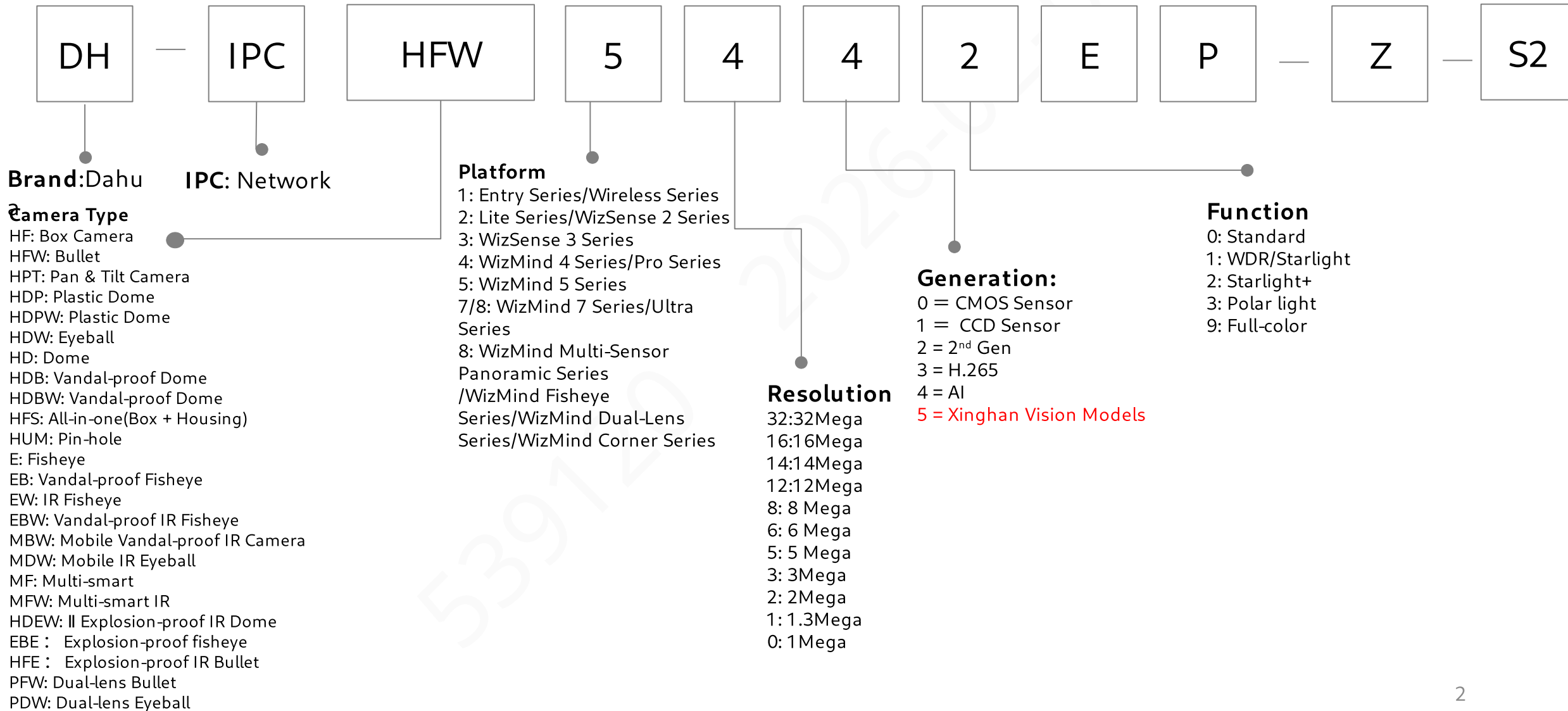

Page	Product	Page	Product
1	/	54-59	Access Control
2-9	Network Camera (Updated)	60-61	Alarm
10-12	HDCVI Camera (Updated)	62-74	ITS (Intelligent Traffic System)
13-15	PTZ Camera	75-77	ICS (Intelligent Charging Solution)
16-17	Interactive Whiteboards	78	Dahua Memory
18-25	Accessory	79-82	Thermal Camera (Updated)
26-28	Network Recorder (Updated)	83-97	Display & Control
29-32	HDCVI Recorder	98-101	Security Screening Products
33-35	Intelligent Computing	102-107	Mobile Products
36-42	Transmission	108-110	Fire Alarm (Updated)
43-45	MPT	111-116	HYXiPOWER
46	DSS		
47-53	Video Intercom (Updated)		

Network Camera(1/2)



Network Camera(2/2)



Appearance

- C: Bullet/Mini Dome
- E: Bullet / Dome / Eyeball
- E1: Plastic+metal Dome
- TC : Metal Bullet
- EM: Metal Eyeball
- F: Dome / Box Camera / Bullet
- G: Indoor Dome
- H: VF Bullet (with junction box) / Dome(with junction box) / Eyeball
- M/M1: Bullet
- R: Metal Vandal-proof Dome / Metal Bullet/Metal Eyeball
- R1: Dome
- S: Eyeball / Bullet
- S1: S1 Eyeball
- T: Bullet / Eyeball
- T1: T1 Bullet/T1 Eyeball
- T2: T2 Bullet
- TM: Metal Eyeball
- X: Dual-Lens Camera
- DS1 : Non-PoE S1 Bullet
- DV : Non-PoE Eyeball
- DG : Non-PoE G Bullet
- DF : Non-PoE F Bullet

- DK1: Non-PoE K1 Bullet
- DR1: Non-PoE R1 Dome
- QM: Quick Installation Metal Eyeball
- TL: TL Metal Bullet
- HA: Indoor PT A Appearance Camera
- PA: Outdoor PT A Appearance Camera
- Z : PTRZ Dome and Z type Bullet
- Z1 : Z1 type Bullet with junction box
- J: Self-Cleaning Bullet

Video format

- P: PAL
- N: NTSC
- (Cancellation of P/N mark for external models of products released after 2021)

Common function:

- | | |
|----------------------------------------|-------------------------------------------------------------|
| BV: Behaviors | 4G: 4G |
| W: WIFI | WG: WiFi & GPS |
| AW: Audio/Alarm/SD WIFI Camera | FD: Face Detection |
| E: E PoE | FR: Face Recognition |
| M/M12: Mobile | ME: Mobile dome |
| F: Fiber interface | U:USB |
| H: Heater | D2: Dual sensor |
| A: Built-in MIC(only for Entry Series) | IL: Smart Dual Light |
| A2: Dual Audio | P: Wide Angle |
| PT: pan &Tilt | SP: Solar Panel |
| S: SD card | 180: 180° |
| AS: Audio & Alarm & SD Card | E2: 2 lens |
| VF: Vari-focal | E3: 3 lens |
| T: Built-in Mic & Speaker | HDMI: HDMI Port |
| Z: Motorized lens | PRO: WizColor |
| Ix: IR numbers | PROX: WizColor 2.0 |
| NI: Full color, non IR | BAT: Battery |
| LED: White light illumination | MAX: Enhanced version, generally refers to battery capacity |
| Z4/5/12: 4/5/12X zoom | ATC: Anti-corrosion |
| L1/L2/L3/L4/L5: Lens | PD : Parking space status detection |
| MF: High Frame | A: Splicing |
| SFC: Separated Front Cover | B: No-splicing |
| 3D: 3 Dimensional | AC : AC220V power |
| LI: Dual Light Fusion | SC : Self-Cleaning |
| PV: Perimeter Vigilance | |
| 5G: 5G | |

S2 : Second generation
Sn : Nth generation

Network Camera(Multi-sight Series)

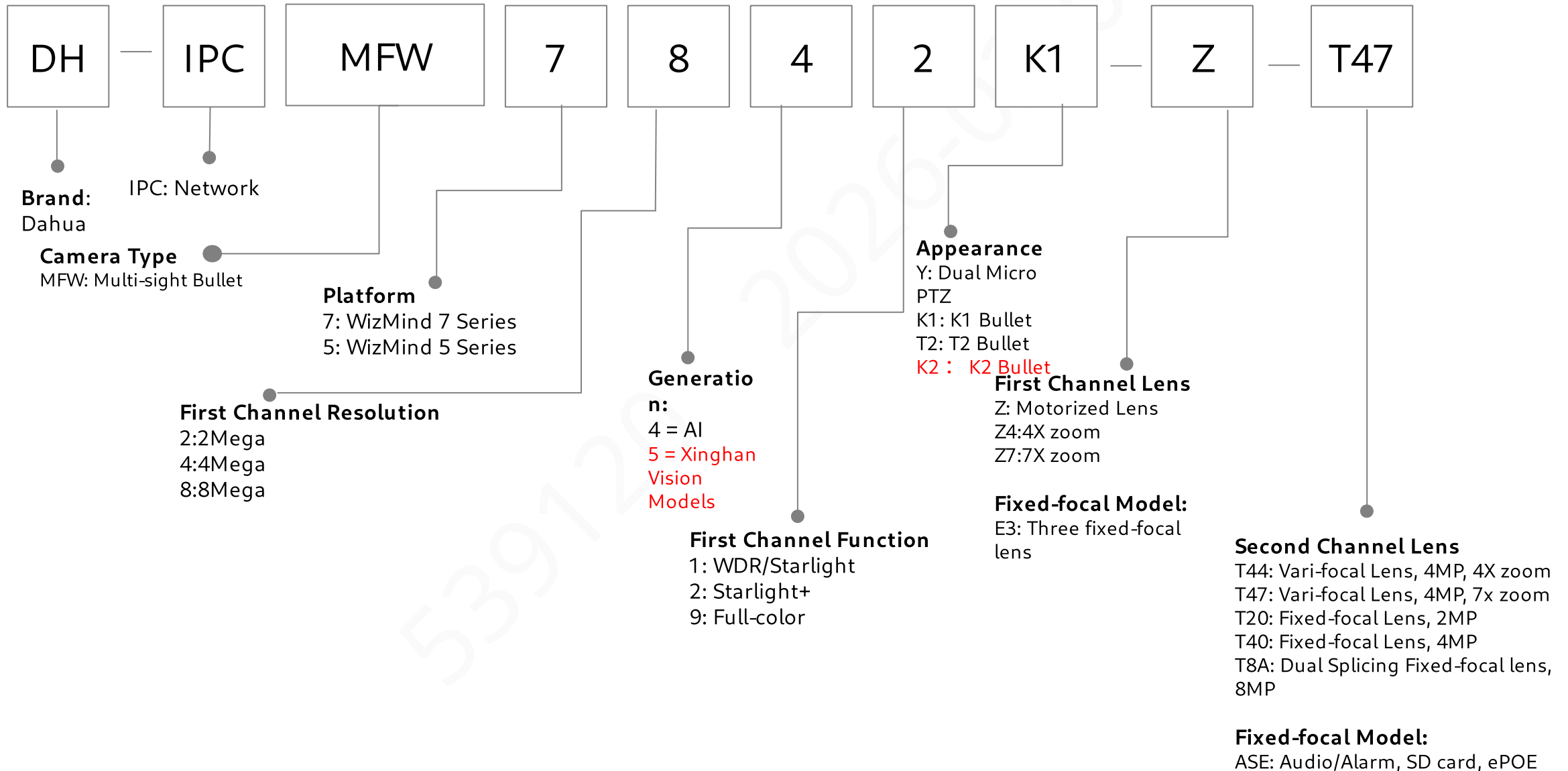

Network Camera (Panoramic Series)

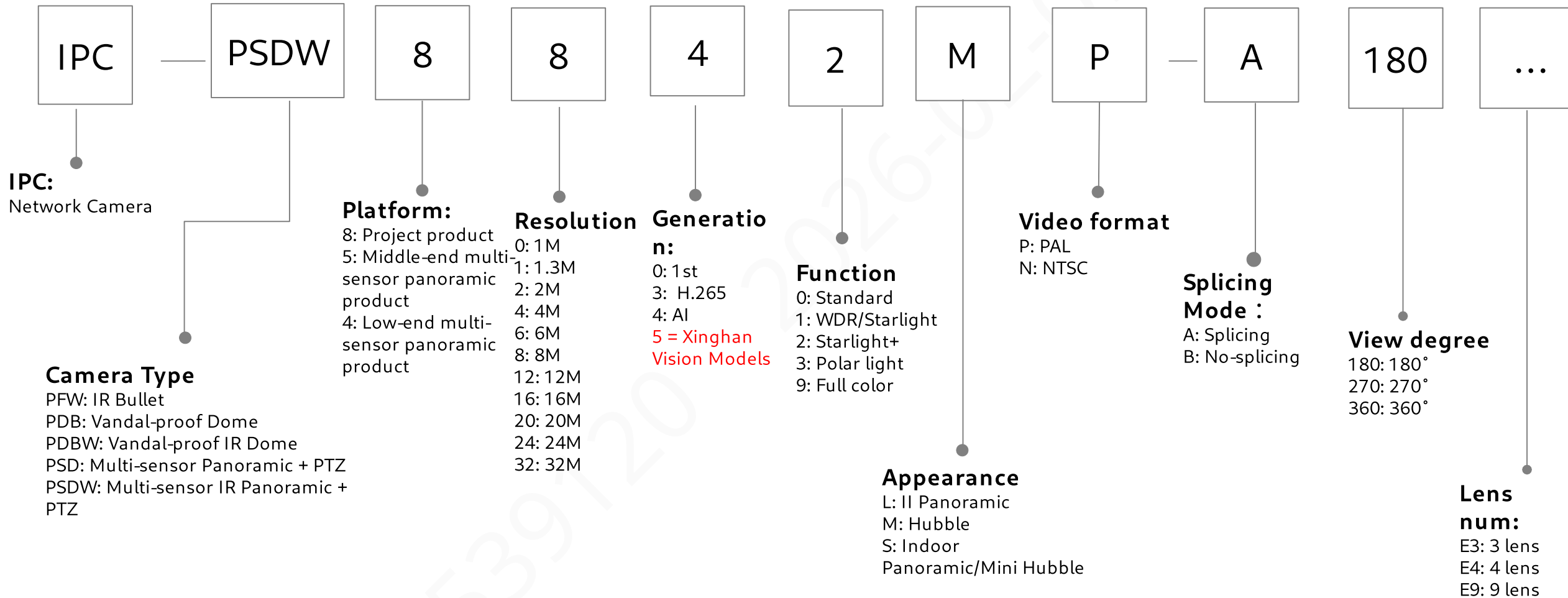

Network Camera (ECO Series)

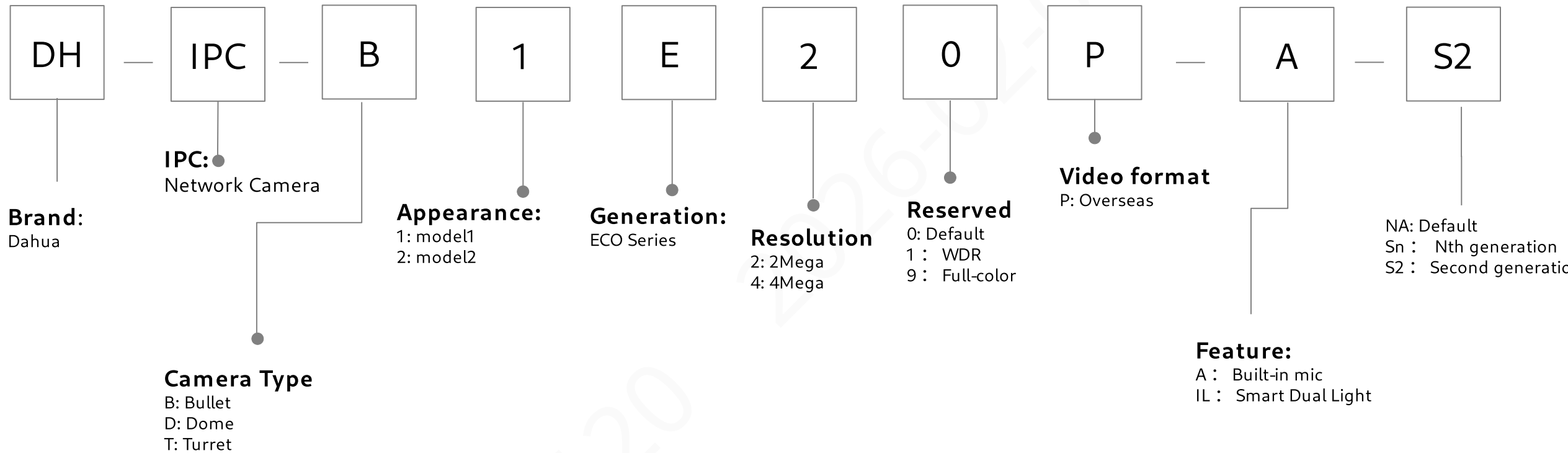

For example : 4MP ECO Smart Dual Light Fixed-focal Bullet Network Camera

Internal Model : DH-IPC-B1E49P-A-IL-0360B-S2

External Model : DH-IPC-B1E49-A-IL

Network Camera(Wireless Series-IT Channel)

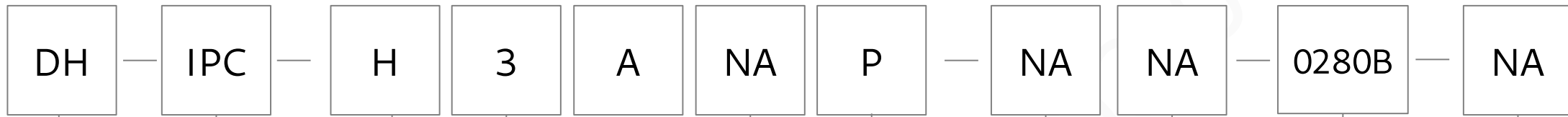

Brand:Dahua

IPC: Network

Camera Type

- C: Cube Camera
- H: Indoor PT Camera
- P: Outdoor PT Camera
- T: Turret Camera
- F: Bullet Camera
- D: Dome Camera
- L: Floodlight Camera
- B: Battery Camera
- BF: Battery Bullet Camera
- BH: Battery Indoor PT Camera
- BP: Battery Outdoor PT Camera

Resolution

- 5: 5 Mega
- 4: 4 Mega
- 3: 3 Mega
- 2: 2 Mega

Appearance

- A: A Appearance
- B: B Appearance
- C: C Appearance
-

- NA: Default
- C: Cost down
- E: Enhancement
- S: Supreme

Identification:

P: Overseas

Lens Type:

- NA: Default
- Zx: x times Electric Zoom
- xZx: x Resolution * x times Electric Zoom
- xF: x Resolution Fixed Focus

Common Function:

- NA: Wi-Fi
- LED: warm light
- IL: Smart Dual Light
- 4G: Support 4G
- 5G: Support 5G
- P: PoE
- PV: Perimeter Vigilance (Battery Camera not add "-PV")

Lens:

- 0210B: 2.1mm
- 0280B: 2.8mm
- 0360B: 3.6mm
- 0600B: 6mm
- 0800B: 8mm

Additional Attribute

- NA: Default
- 1. Hardware generation:
 - S2 : Second generation
 - Sn : Nth generation
- 2. Battery type:
 - MAX= Wide Temperature Battery
 - XL=Large-Capacity Battery Version
- 3. Color:
 - Ash
 - Pearl
- 4. WizColor: PRO
- 5. Region: EUR

Network PT Camera(1/2)

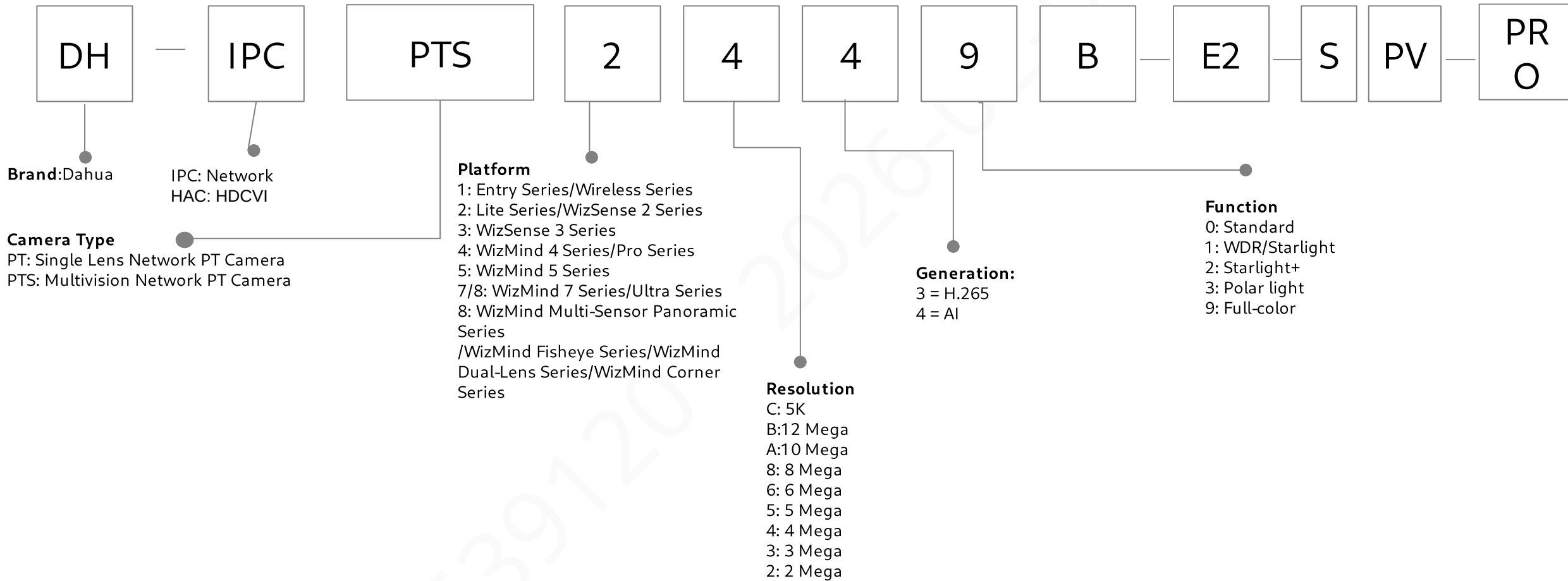

Network PT Camera(2/2)

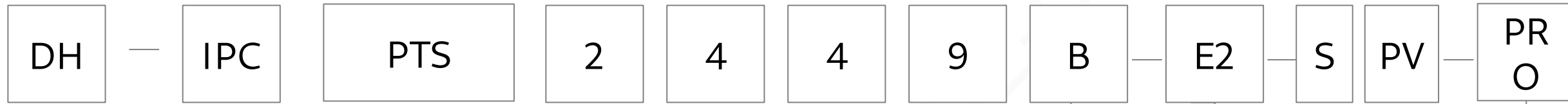

Appearance

D: Non-PoE Model
H: Indoor Eyeball
Ax: Outdoor 1 Series PT camera
Bx: Outdoor 2 Series PT camera
Cx: Outdoor 3 Series PT camera

Multi-lens Model

x= panoramic channel resolution , If it is the same as the detail channel, it did not show.
y= total number of panoramic and detail lenses

Common function:

S: SD Card(PT-1 Series); SD Card+Mic(Expect PT-1 Series)
SA: SD Card+Mic (Only for PT-1 Series)
AS: Audio & Alarm & SD Card
SW: SD Card+WiFi
SAW : SD Card+Mic+WiFi
ST: SD Card+Two way talk(Indoor Type)
STW: SD Card+Two way talk+WiFi
STWB20: SD Card+Two way talk+WiFi+20000mAh Battery
Z: Hybrid Zoom
4G: 4G
5G: 5G
PV: Perimeter Vigilance (Outdoor Type)
IL: Smart Dual Light
LED: Warm Light
.....

PRO: WizColor
BK: Black color model
Sn : Nth generation
Pearl : Pearl White
Ash: Metal grey
Jordan: Jordan model
USA: US model
CAN : Canada model
.....

HDCVI Camera (1/2)

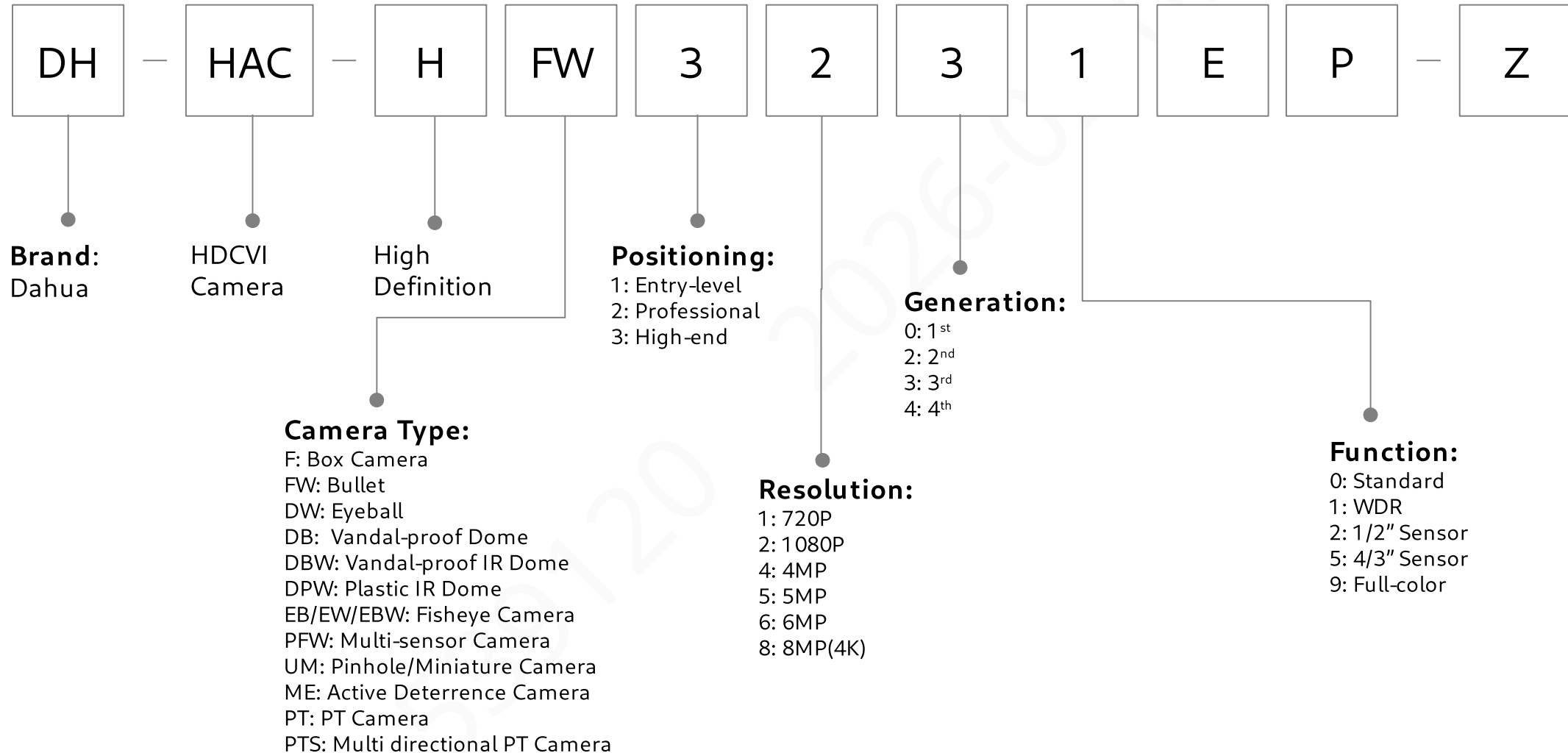

HDCVI Camera (2/2)



Case :

- A : IR Cube/ PT Camera
- B : Active Deterrence Bullet/ Pinhole Camera/PT Camera
- C : Active Deterrence Bullet / Plastic Bullet/PT Camera
- CL: Plastic Bullet
- RL: Plastic Bullet
- CLQ: Quick-to-install Plastic Eyeball
- CM: Metal Bullet
- RM: Metal Bullet
- D: Active Deterrence Bullet/ Metal Bullet
- E : Metal Bullet/Metal Dome
- EA : Metal Dome
- EQ: Active Deterrence Quick-to-install Eyeball
- EM: Metal Eyeball
- F: Metal Wedge Dome
- G : Micro-size Bullet/ Box
- H : TiOC Metal Eyeball

- M : Metal Eyeball
- R: Plastic Bullet/ Plastic Eyeball
- RA: Metal Dome
- R-Z: Metal Bullet/ Metal Dome
- S: Metal Bullet
- T: Metal Bullet/ Metal Eyeball
- T-Z: Metal Bullet/ Metal Eyeball
- T-I8: Large size Metal Bullet
- TE: Metal+Plastic Eyeball
- TH-I4: IR 40m Bullet (Metal Bracket)
- TH-I8: IR 80m Bullet (Metal Bracket)
- TL: Bullet/Eyeball
- TLM: Metal Bracket Bullet
- TM : Metal Bullet
- X: Wizcolor Bullet/Eyeball
- TQ: Quick-to-install Eyeball (82mm)
- TLQ: Quick-to-install Eyeball (69mm)
- TLMQ: Quick-to-install Metal Eyeball(69mm)
- TMQ: Quick-to-install Metal Eyeball (82mm)
- TRQ: Quick-to-install Eyeball (Without IP67) (69mm)

Video Format:

- P: PAL
- N: NTSC

Feature:

- VF: Manual vari-focal
- Z: Motorized vari-focal
- H: With built-in heater
- T: Two-way Talk
- A: Built-in mic
- DP: Dual-power (AC24V/DC12V)
- POC: Power over coax
- LED: White light
- DIP: Dip switch
- VP: Vandal proof
- TH: Temperature & Humidity
- IL : Smart Dual Light
- E2: Dual lens
- E2Z: Dual lens hybrid vari-focal
- W: Wireless
- IRE6: IR 60m
- PIR: PIR Camera
- L: White Light
- S: Siren
- LS: White Light & Siren
- PV: TiOC Camera

HDCVI Cooper Series (Camera & Recorder)

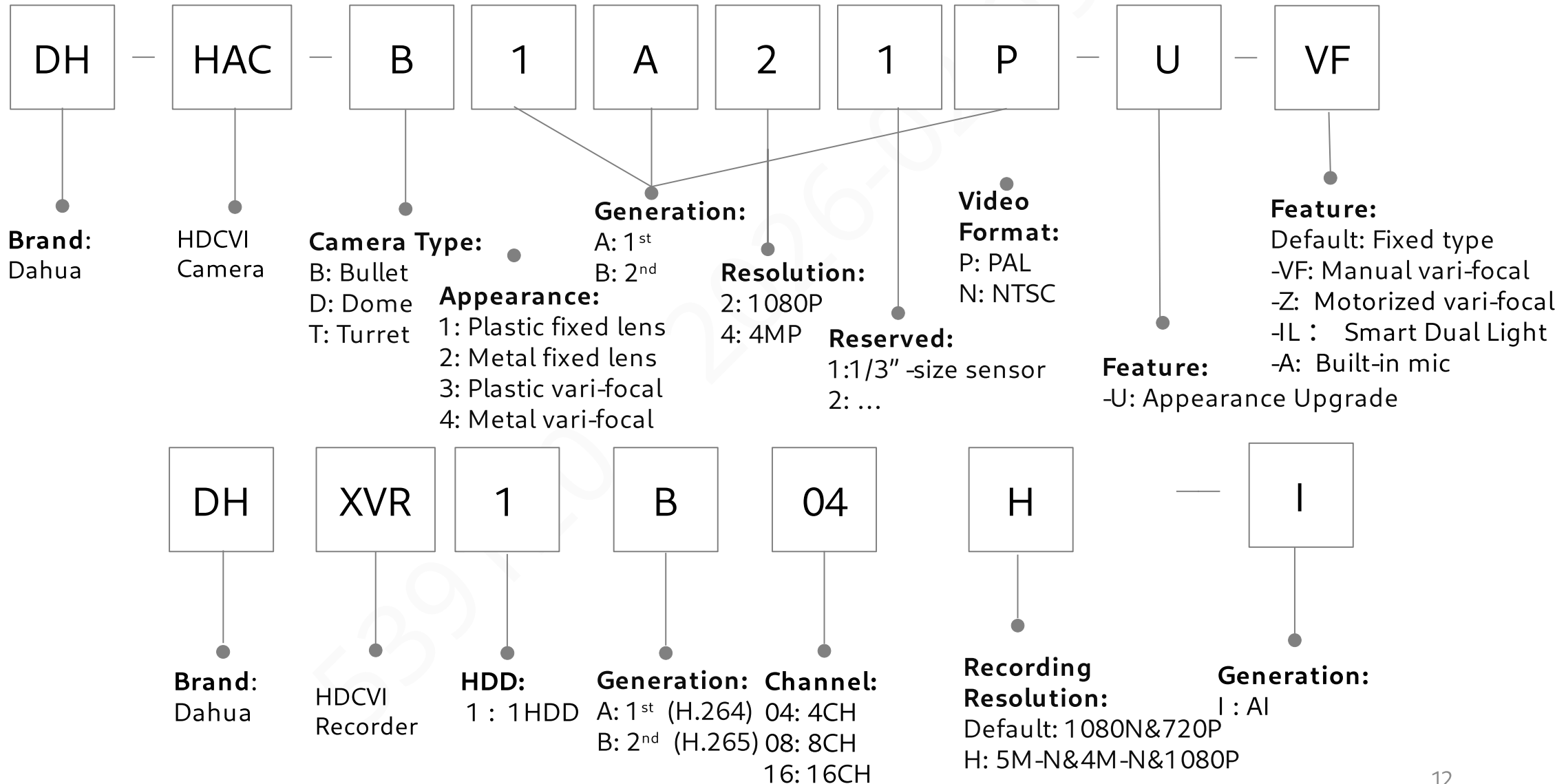

PT Series

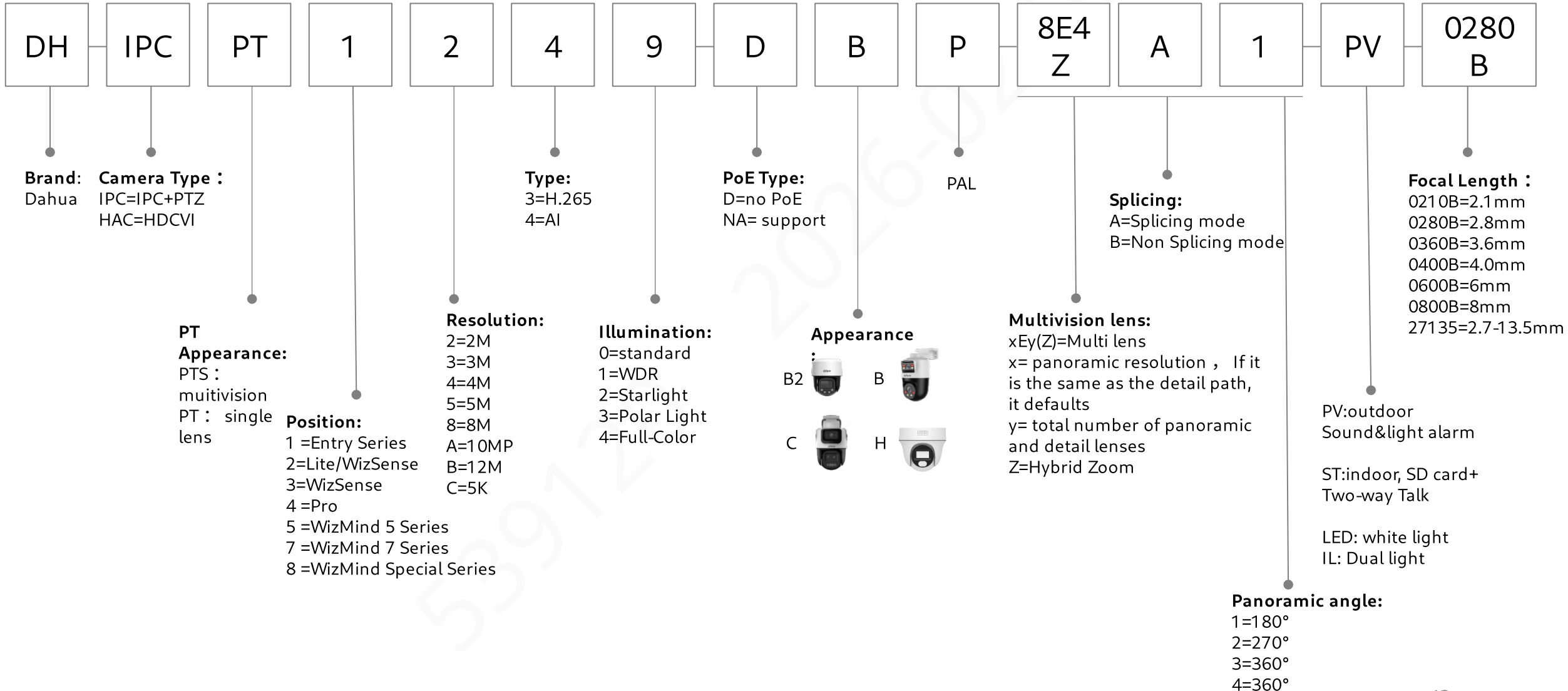

Speed Dome

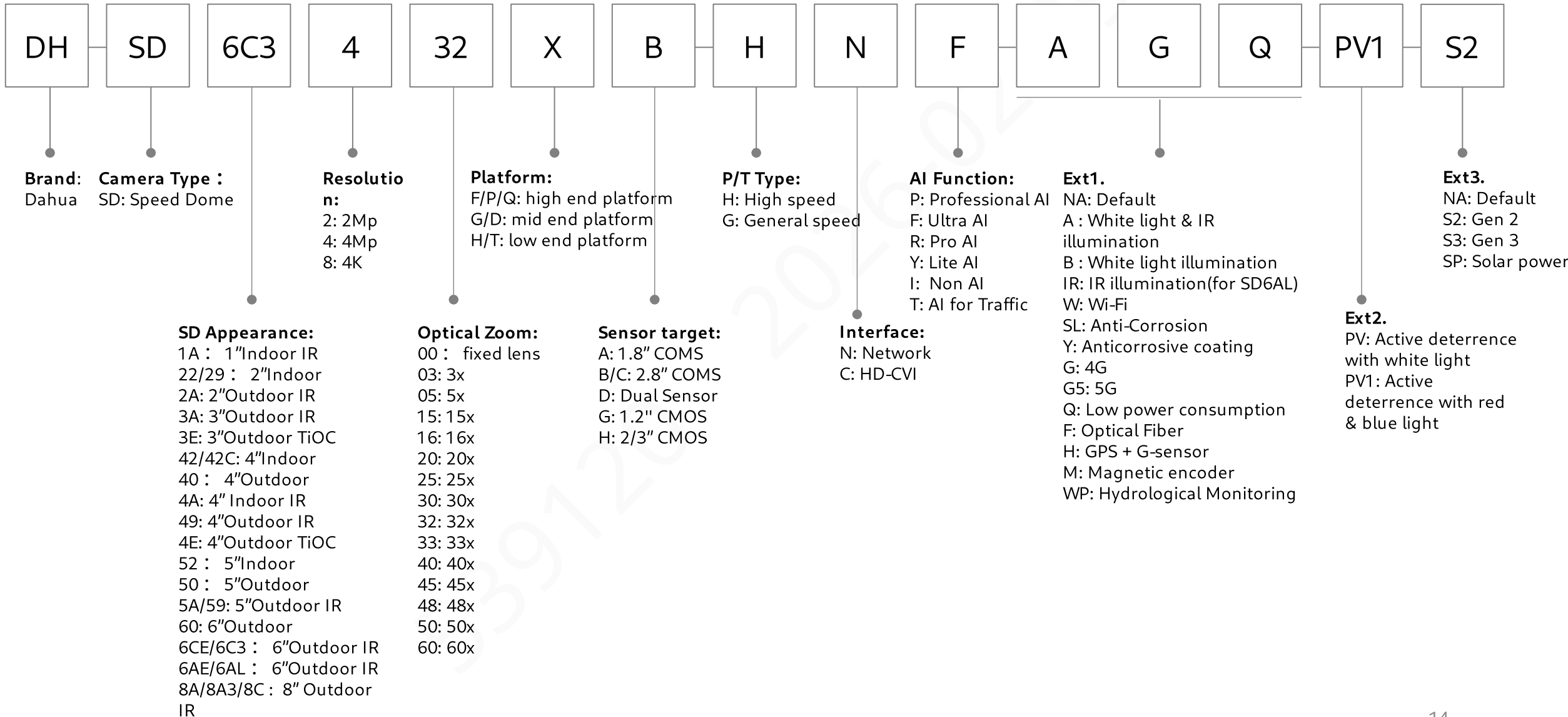

PTZ/Explosion Series & Multi-sensor Series



PTZ: Positioning System
ECA: Explosion camera
Camera Type :



H: High speed
G: General speed
P/T Type:

N: Network
C: HD-CVI
Interface:

F: Ultra AI
R: Pro AI
AI Function:



Brand: Dahua
Camera Type : SDT: Multi-sensor PTZ

PTZ Camera Feature

Resolution
2: 2Mp
4: 4Mp
5: 5Mp
8: 4K

Optical Zoom:
00: fixed lens
03: 3x
04: 4x
12: 12x
16: 16x
25: 25x
30: 30x
31: 31x
32: 32x
33: 33x
40: 40x
45: 45x
48: 48x
50: 50x
60: 60x

Panorama Camera Feature

Resolution
2: 2Mp
4: 4Mp
5: 5Mp
8: 4K

Lens Type
Z: Zoom
F: Fixed lens

Optical Zoom:
4: 4x
5: 5x

Platform:
F/P/Q: high end platform
G/D: mid end platform
H/T: low end platform

Ext1. (NA: Default)
A : White light & IR illumination
B : White light illumination
IR: IR illumination(for SD6AL)

W: Wi-Fi
SL: Anti-Corrosion
Y: Anticorrosive coating

G: 4G
G5: 5G
Q: Low power consumption
F: Optical Fiber

H: GPS + G-sensor
M: Automatic Recovery of Position
L: Laser
JG: Traffic

PTZ Camera Sensor Size:
A: 1/1.8"
B: 1/2.8"
C: 1/2.8"
D: Dual-sensor
F: 4/3"
G: 1/1.2"
H: 2/3"
I: 1/2.9"

Ext 2. (NA: Default)
PV: Active deterrence with white light
PV1: Active deterrence with red

Fixed Zoom:
0118=1.18mm
0142=1.42mm
0185=1.85mm
0280=2.8mm
0360=3.6mm
0600=6mm
0800=8mm
1200=12mm
1600=16mm
2500=25mm

Optical Zoom:
2712=2.7-12mm
0722=7-22mm
4747=4.7-47mm
3711=3.7-11mm
27135=2.7-13.5mm
5364=5.3-64mm
0735=7-35mm



Video Conferencing

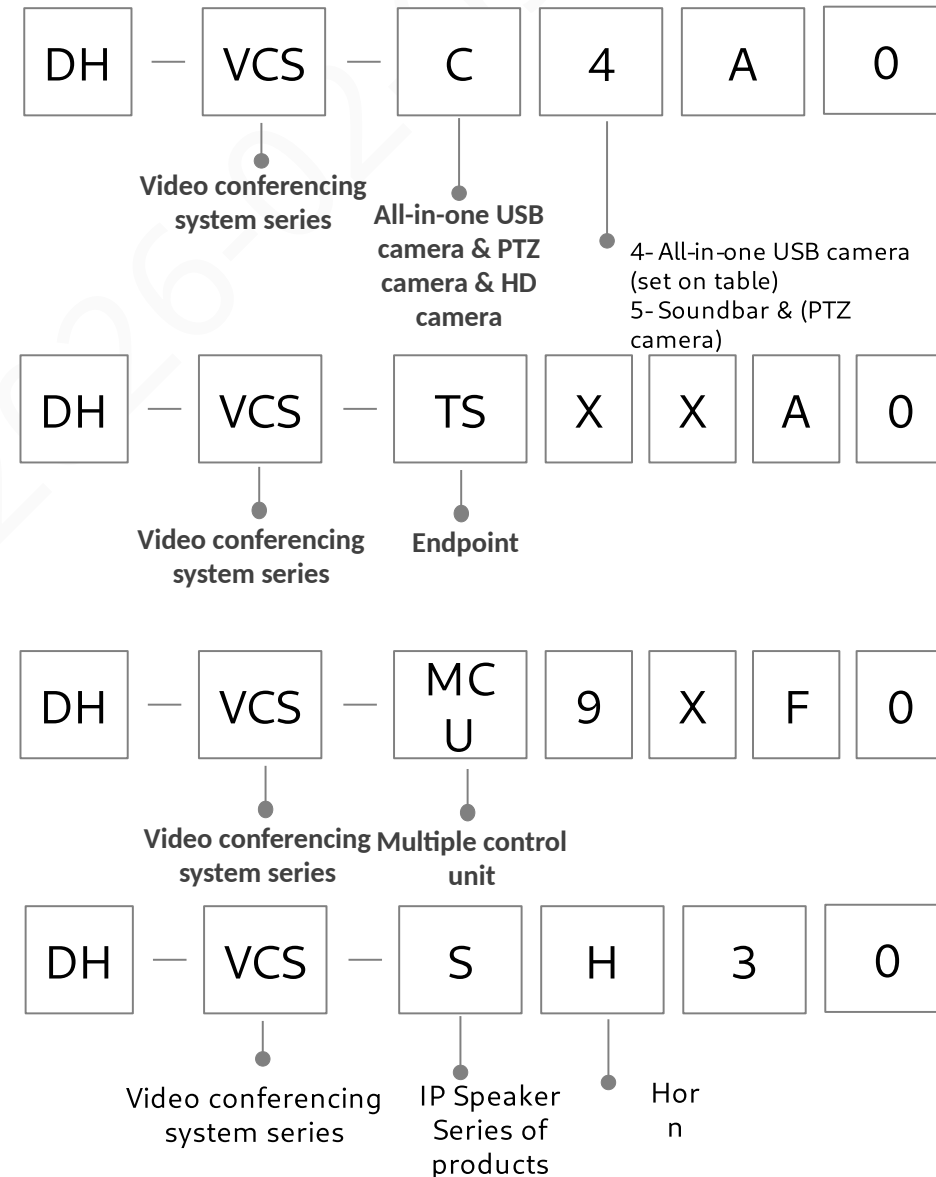
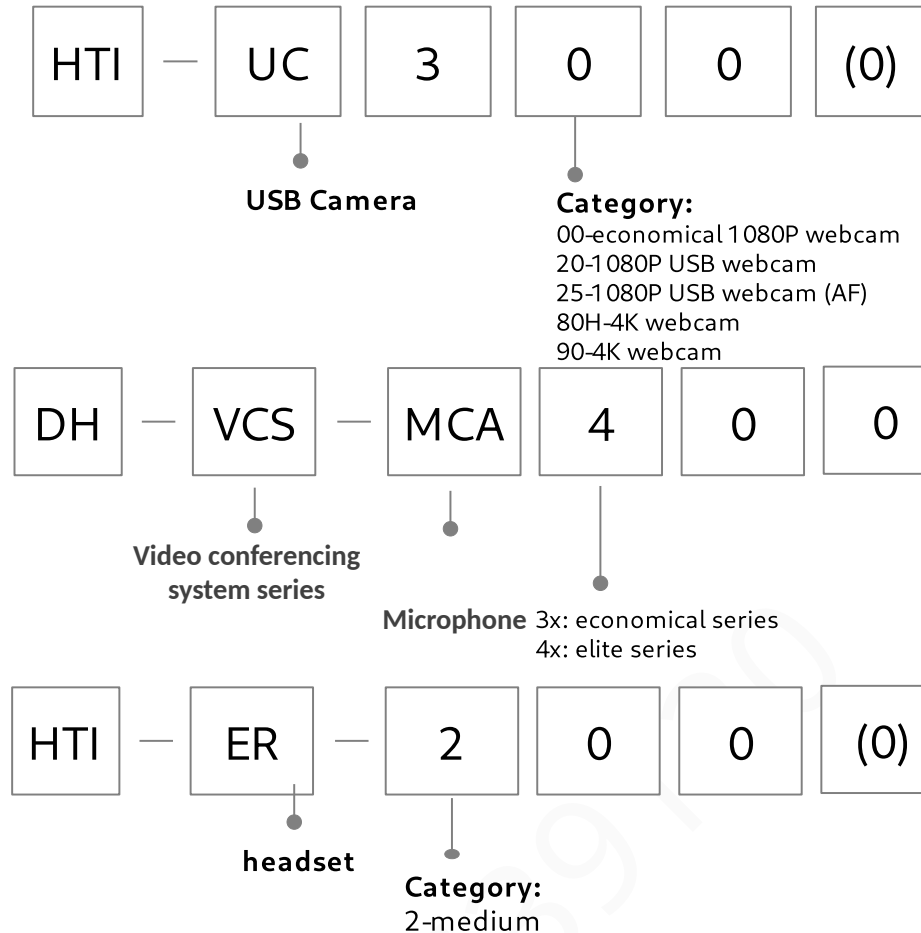

Accessory

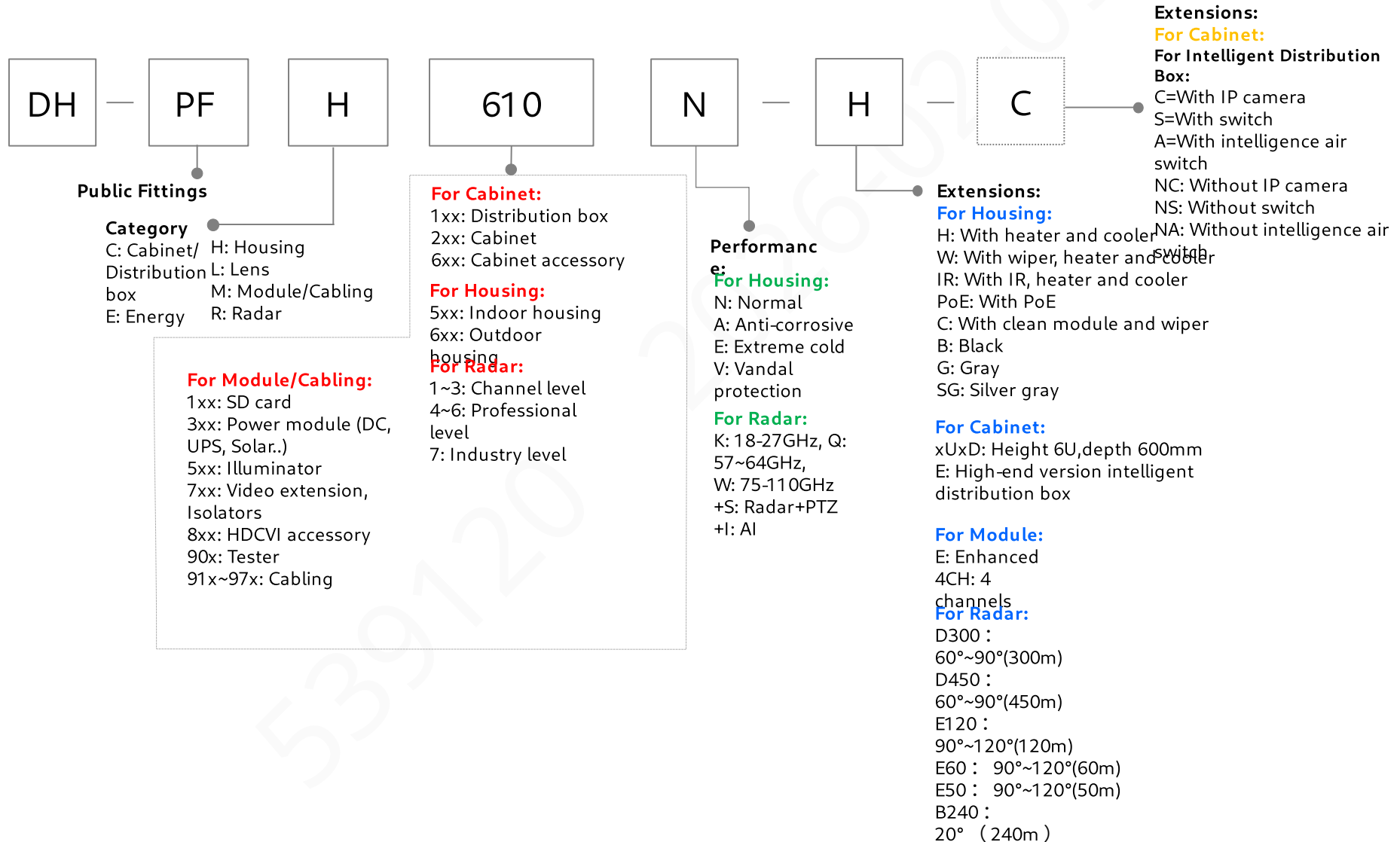

Accessory-Camera mount

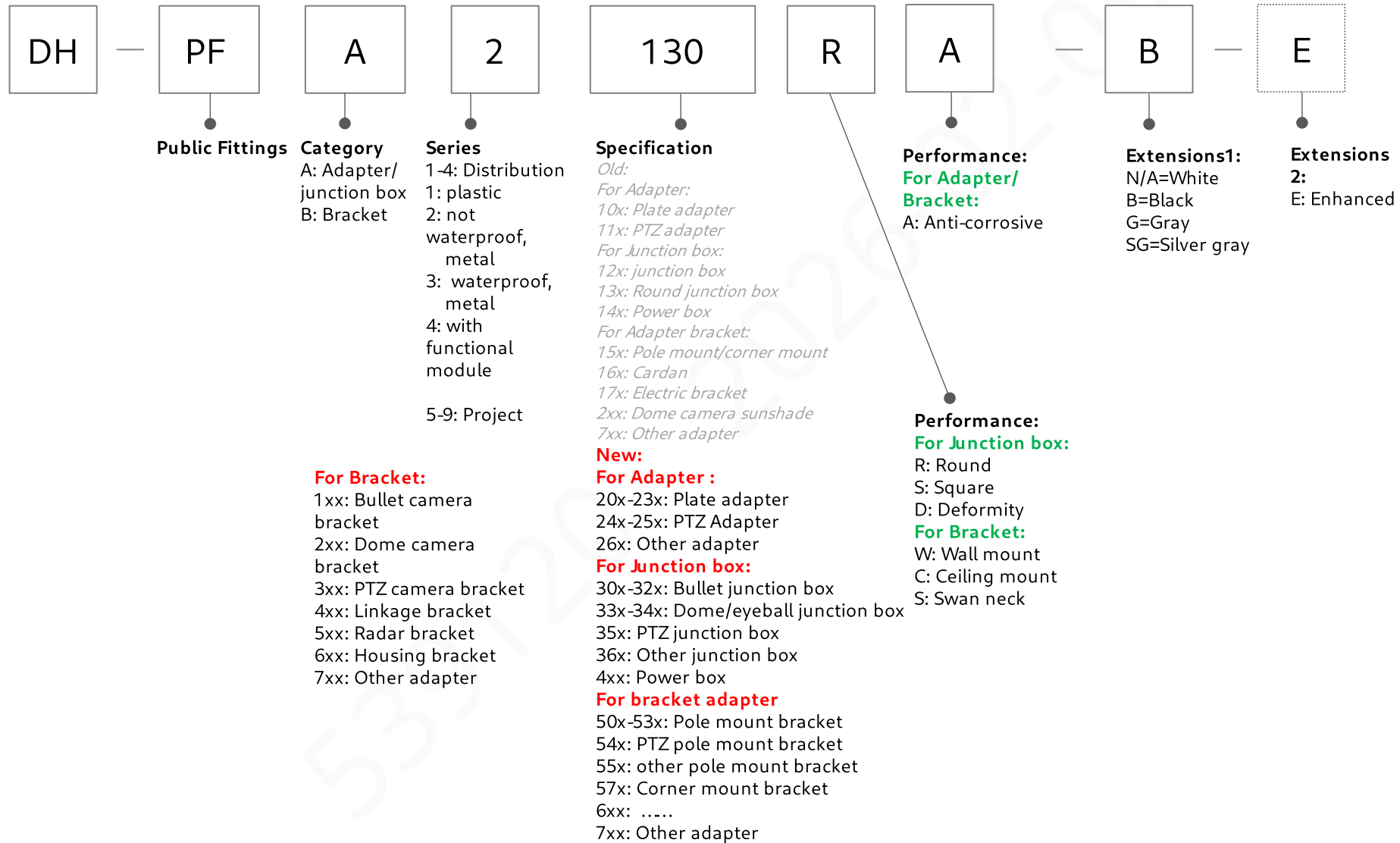

Accessory-Lens

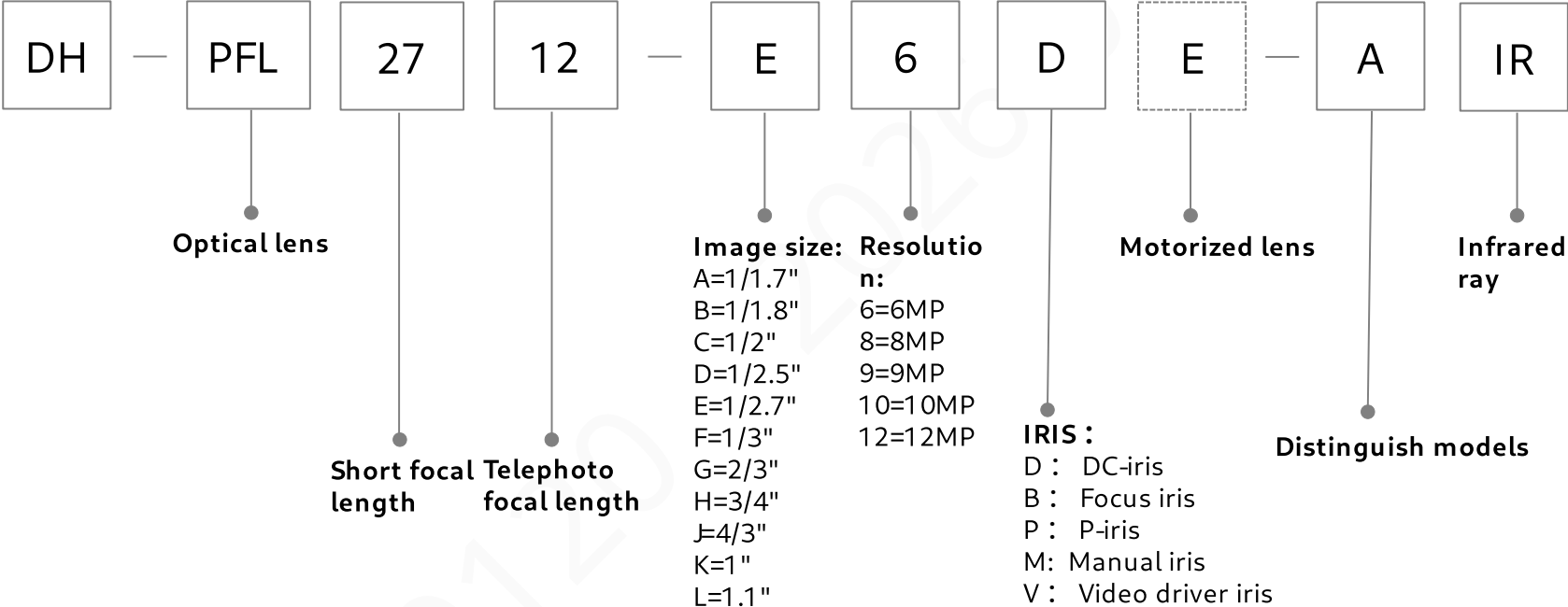

Accessory-power

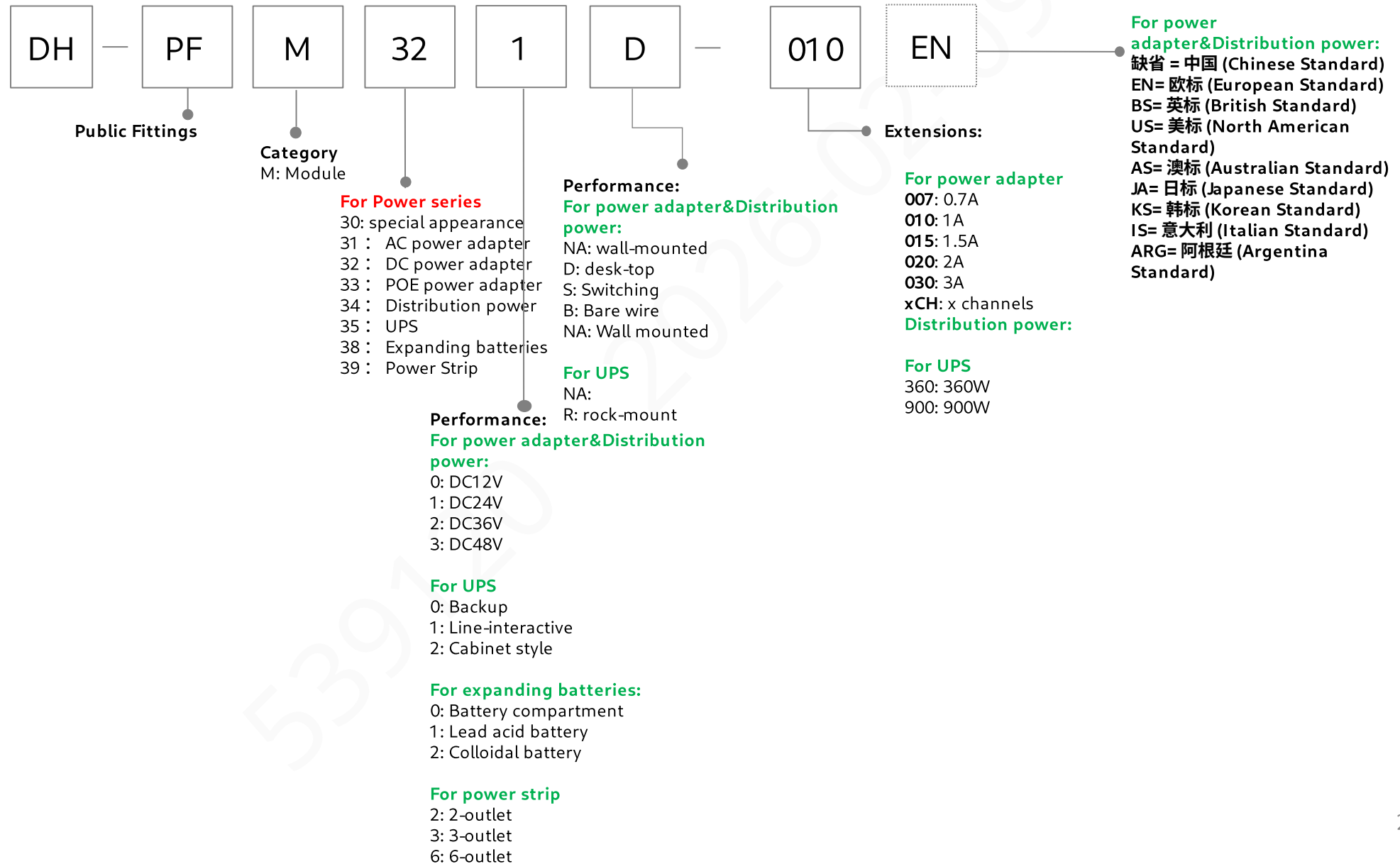

Accessory-Cabling

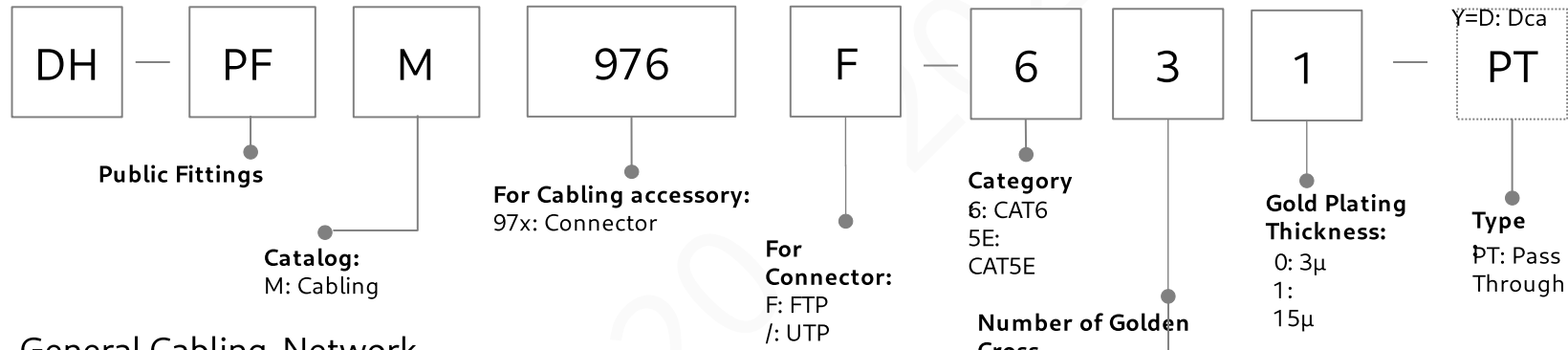
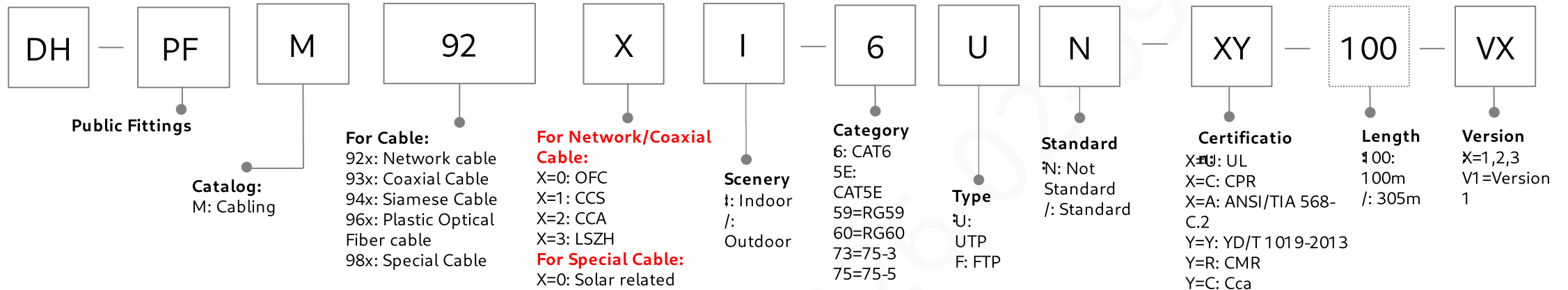

General Cabling-Network

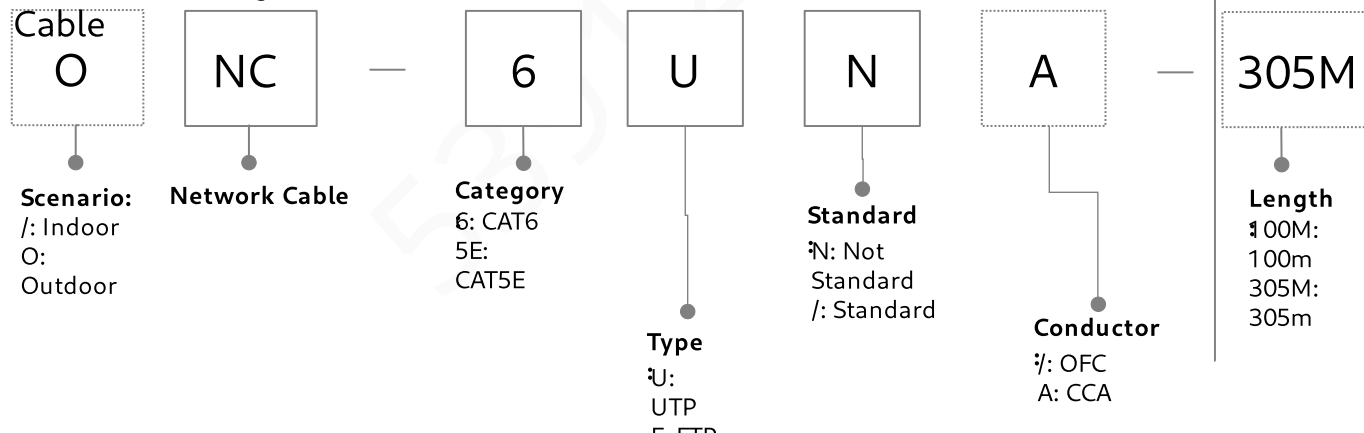

Accessory-Cabling

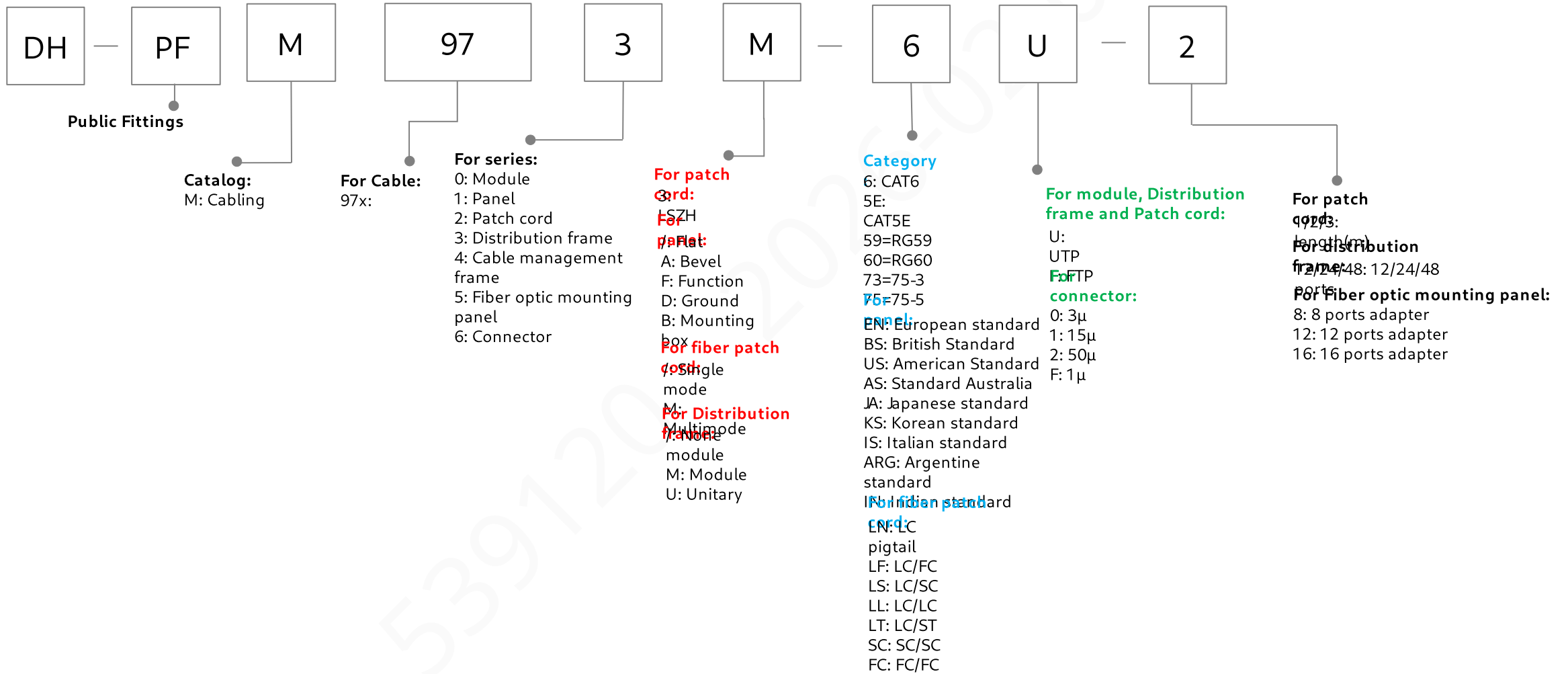

Accessory-Solar

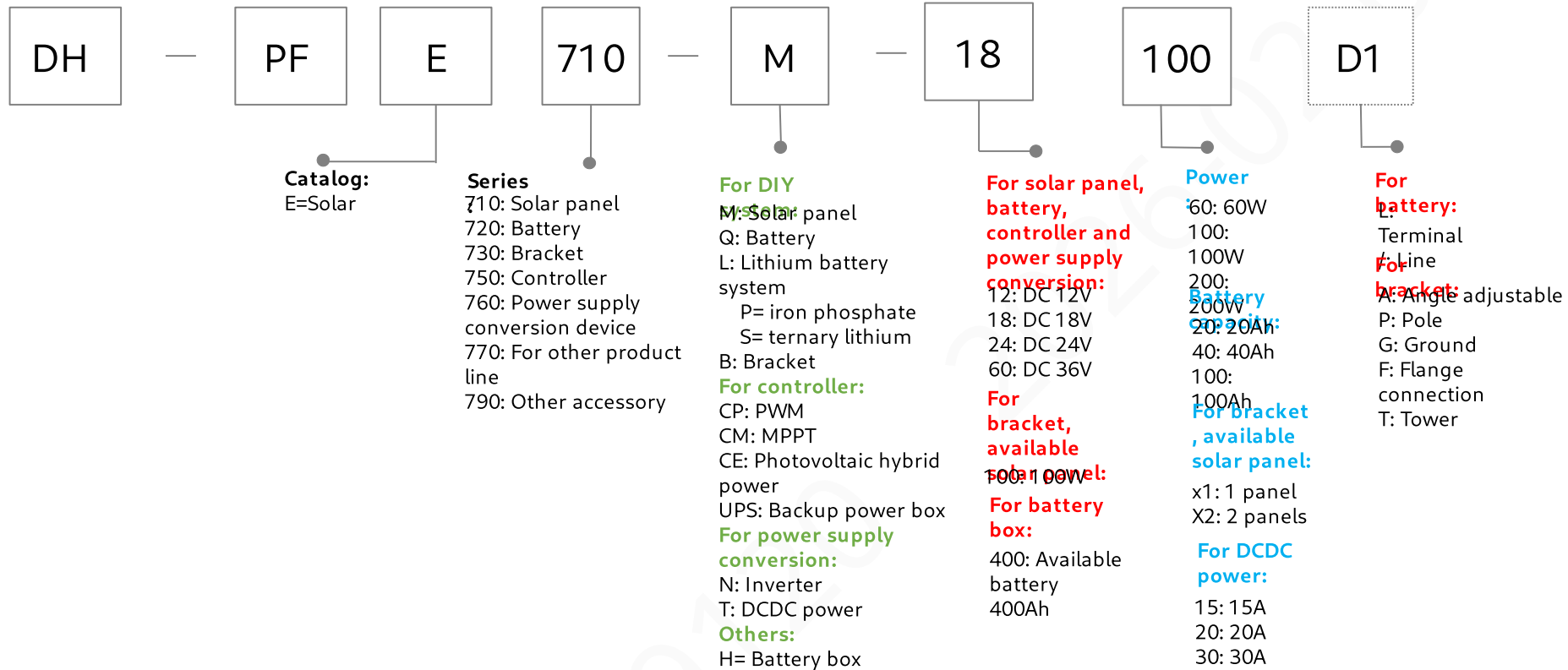

Accessory-Solar

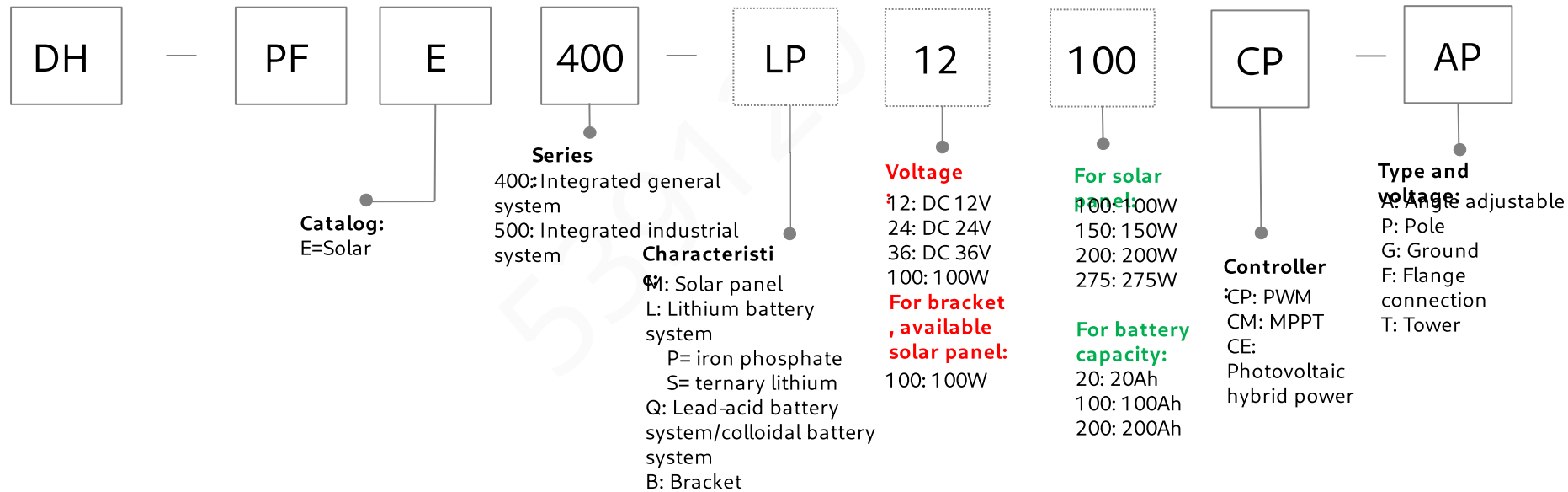
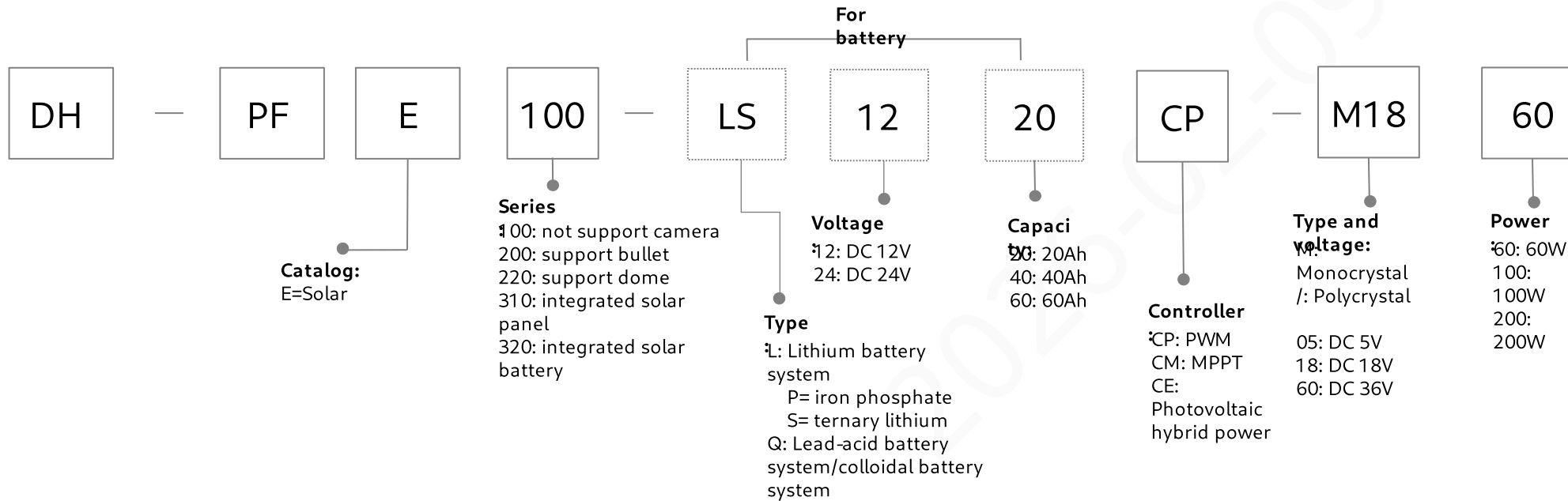

General NVR

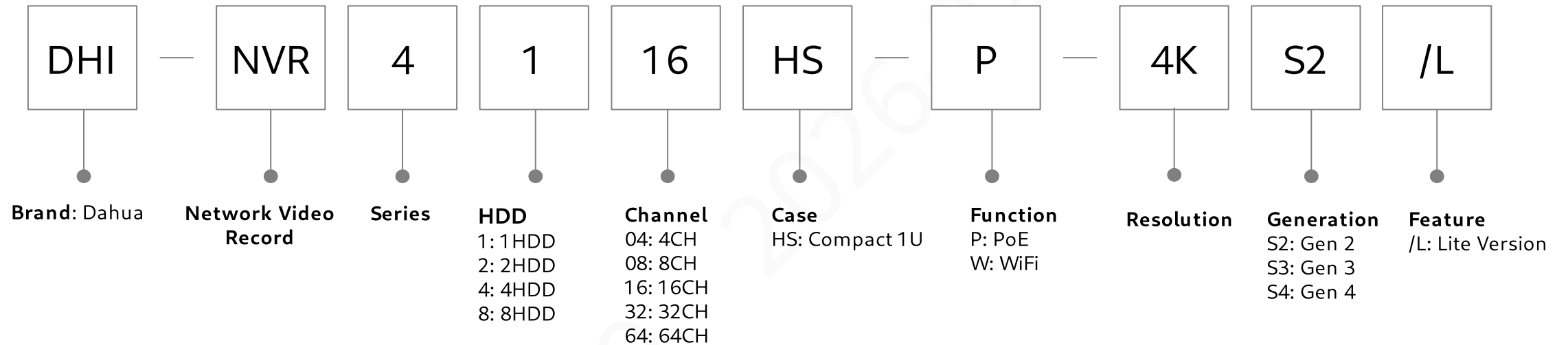

AI NVR

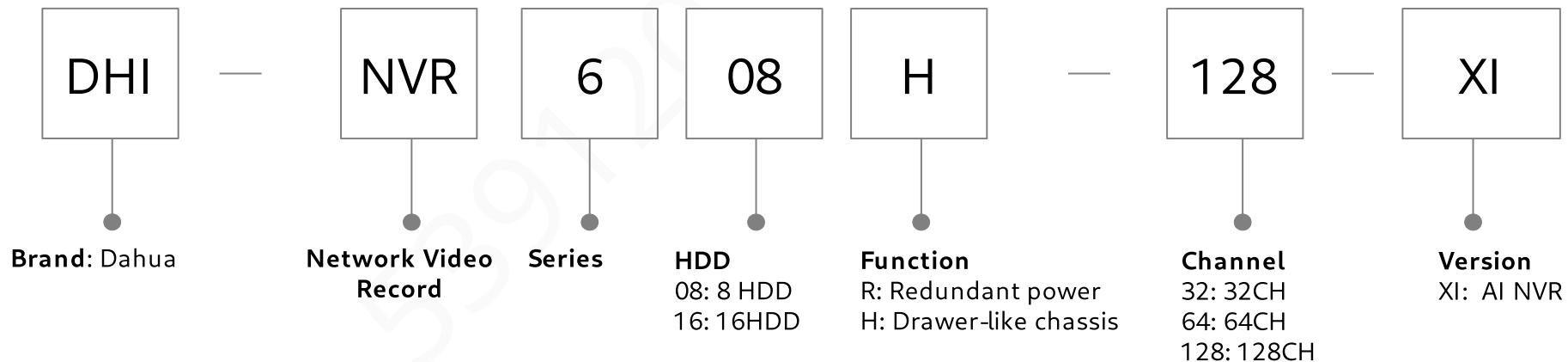
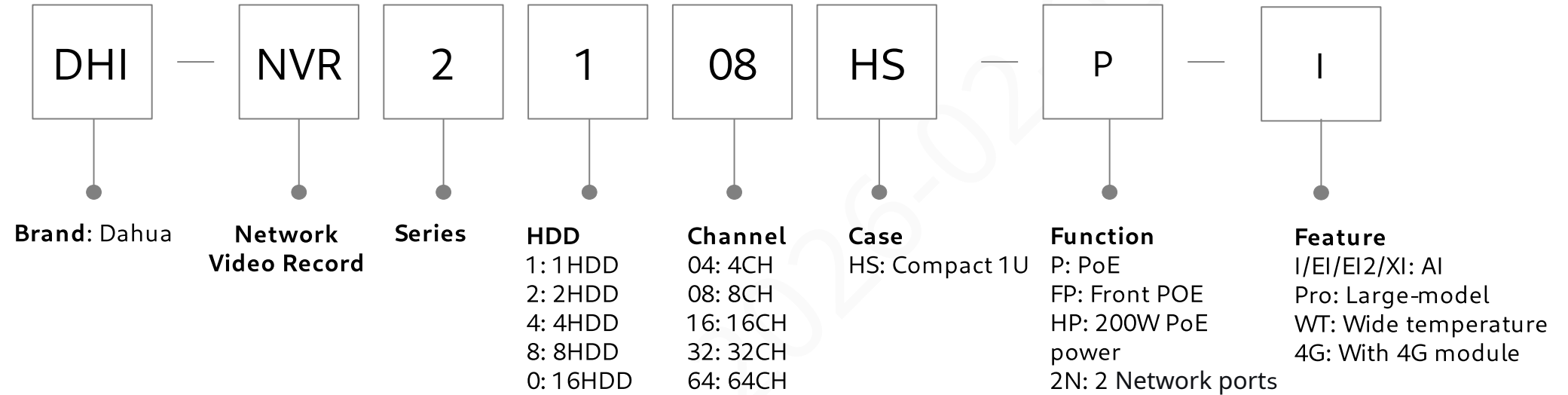

NVR KIT

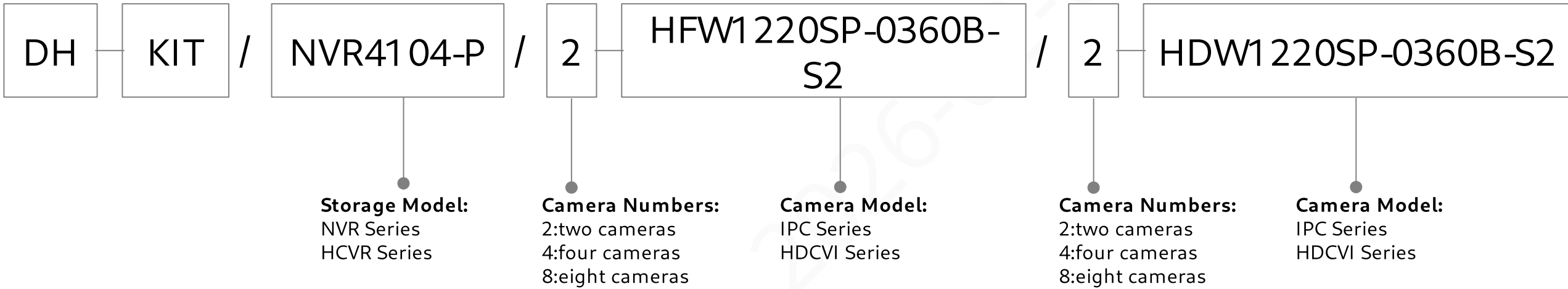

HDCVI Recorder (XVR)

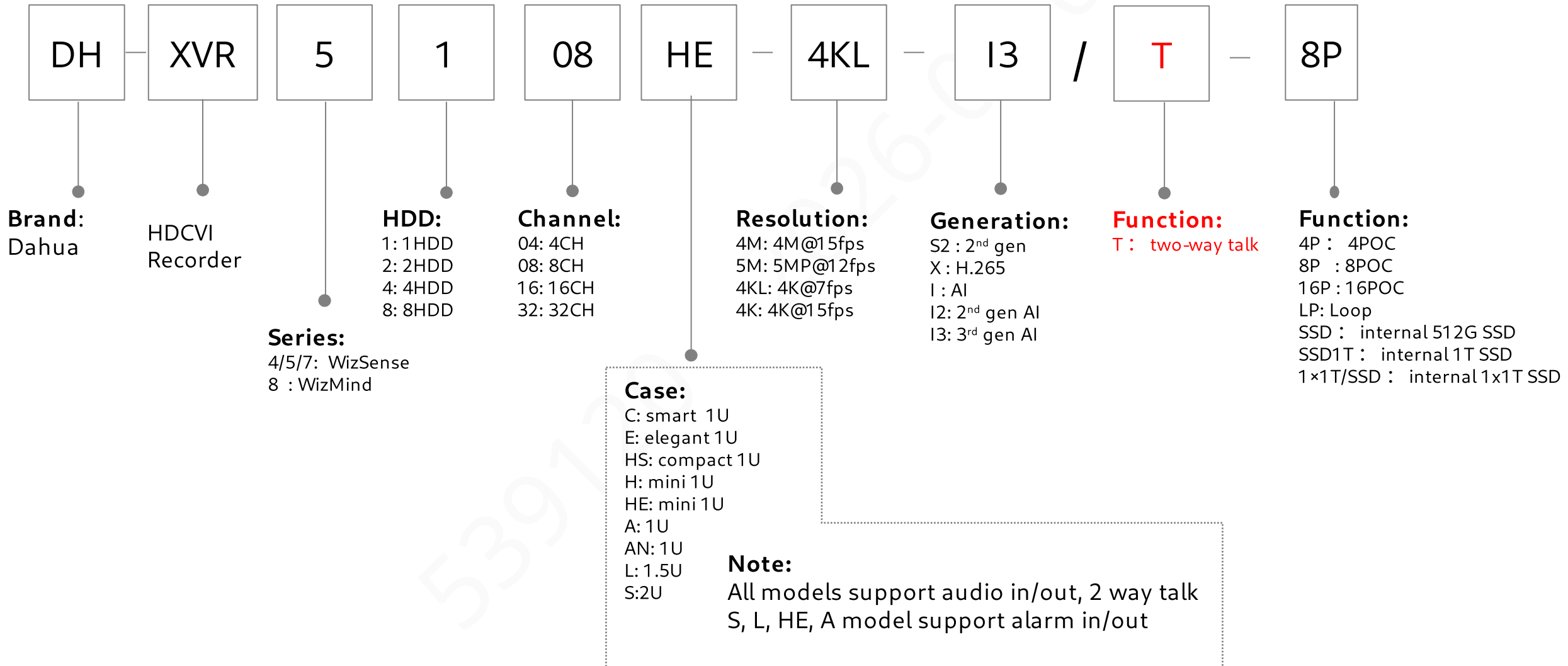

HDCVI Cooper Series (Recorder)

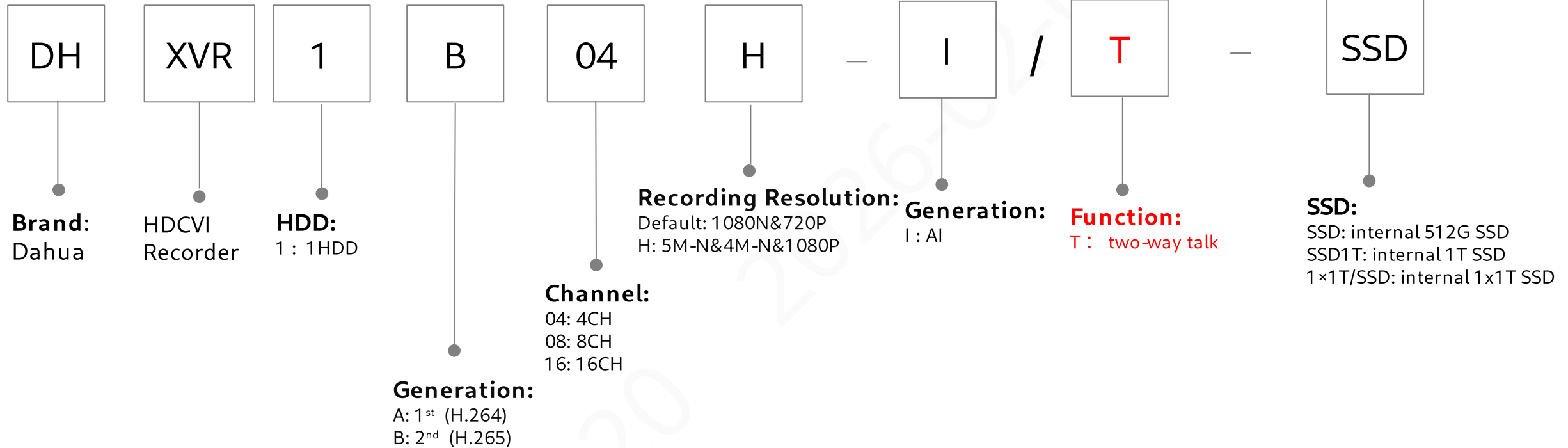

XVR KIT



Storage Model:
NVR Series
HCVR Series

Camera Numbers:
2:two cameras
4:four cameras
8:eight cameras

Camera Model:
IPC Series
HDCVI Series

539120

ATM DVR/NVR

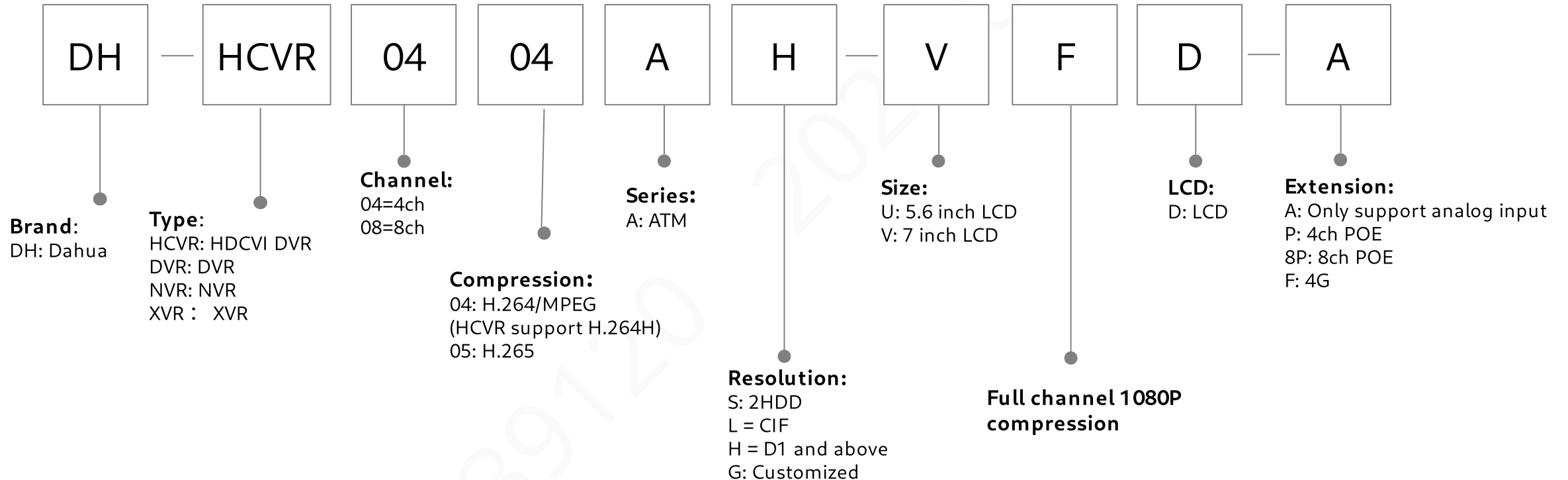

IVSS & IVD

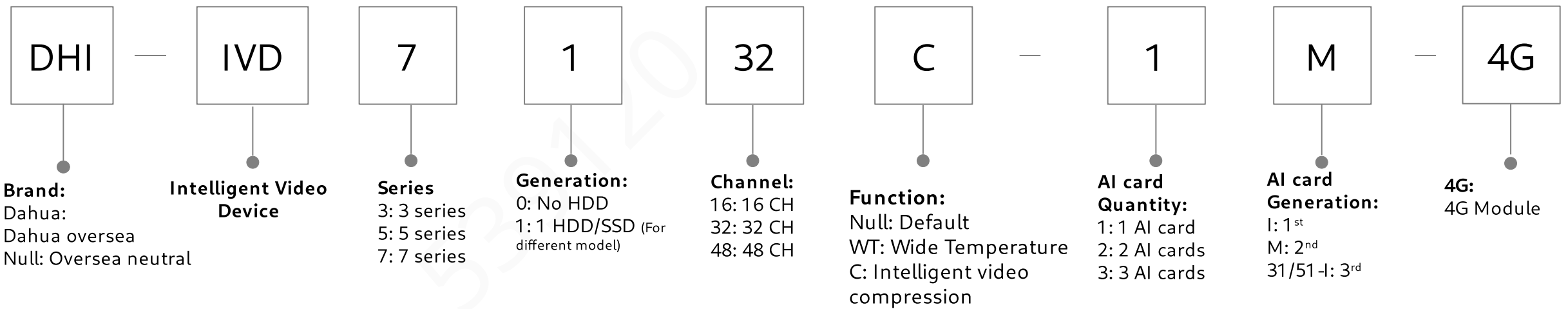
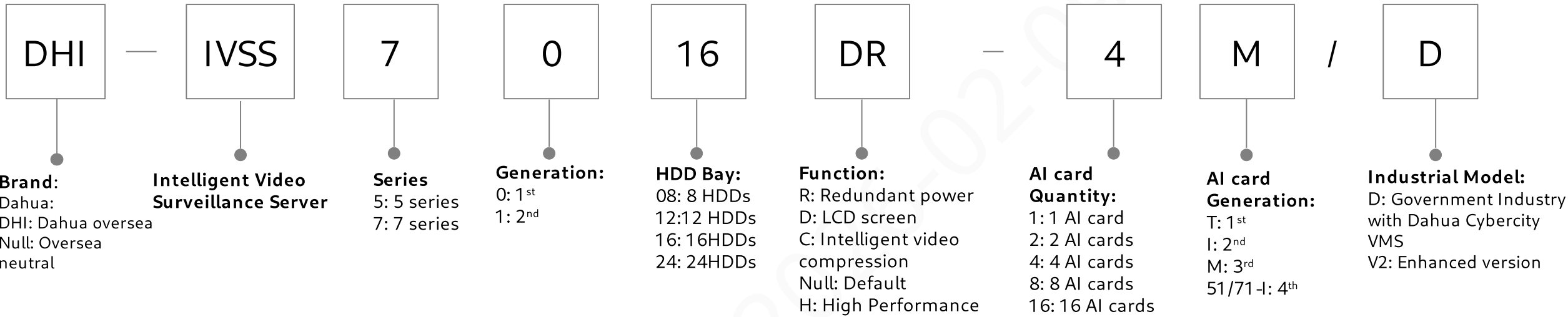

EVS & ESS

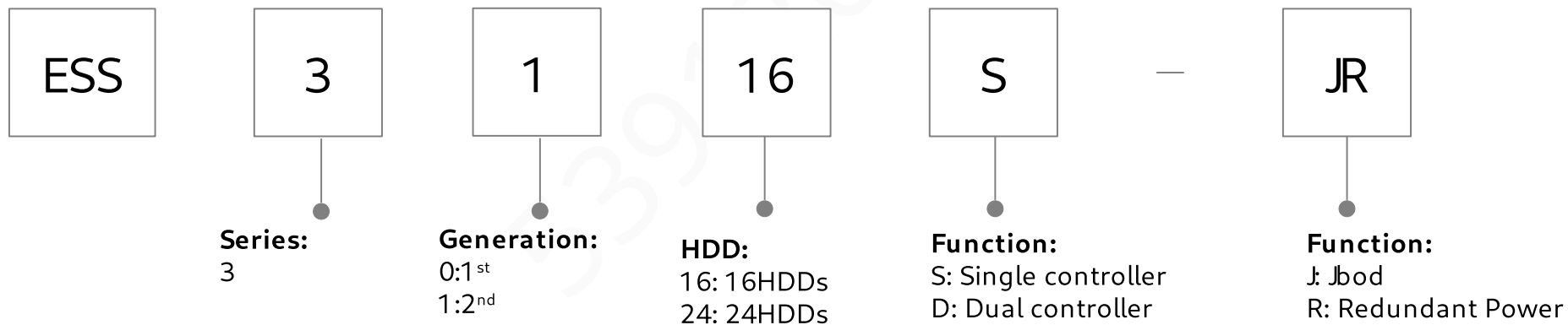
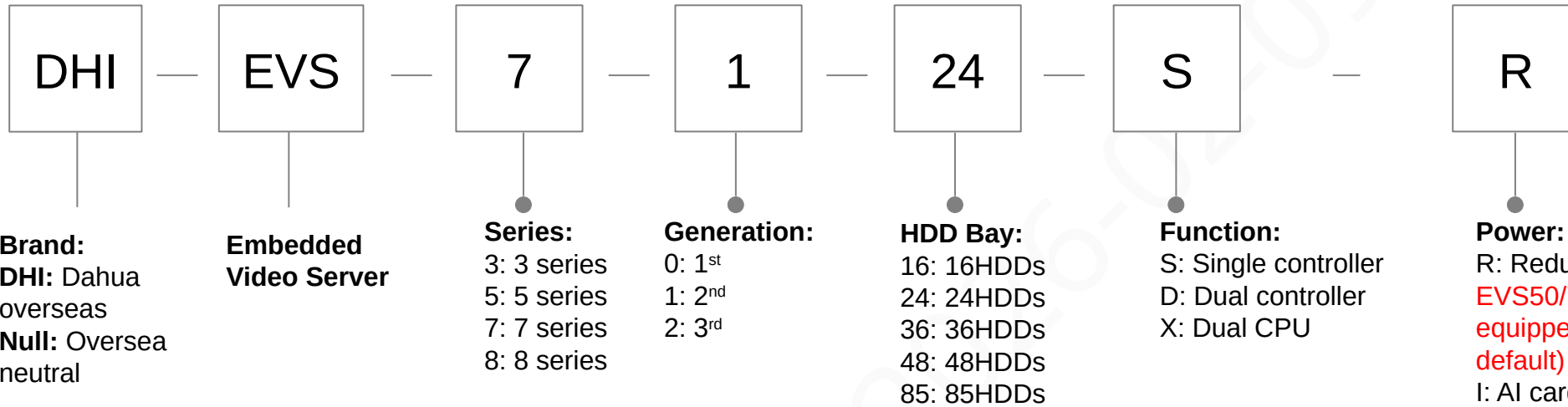

IVS

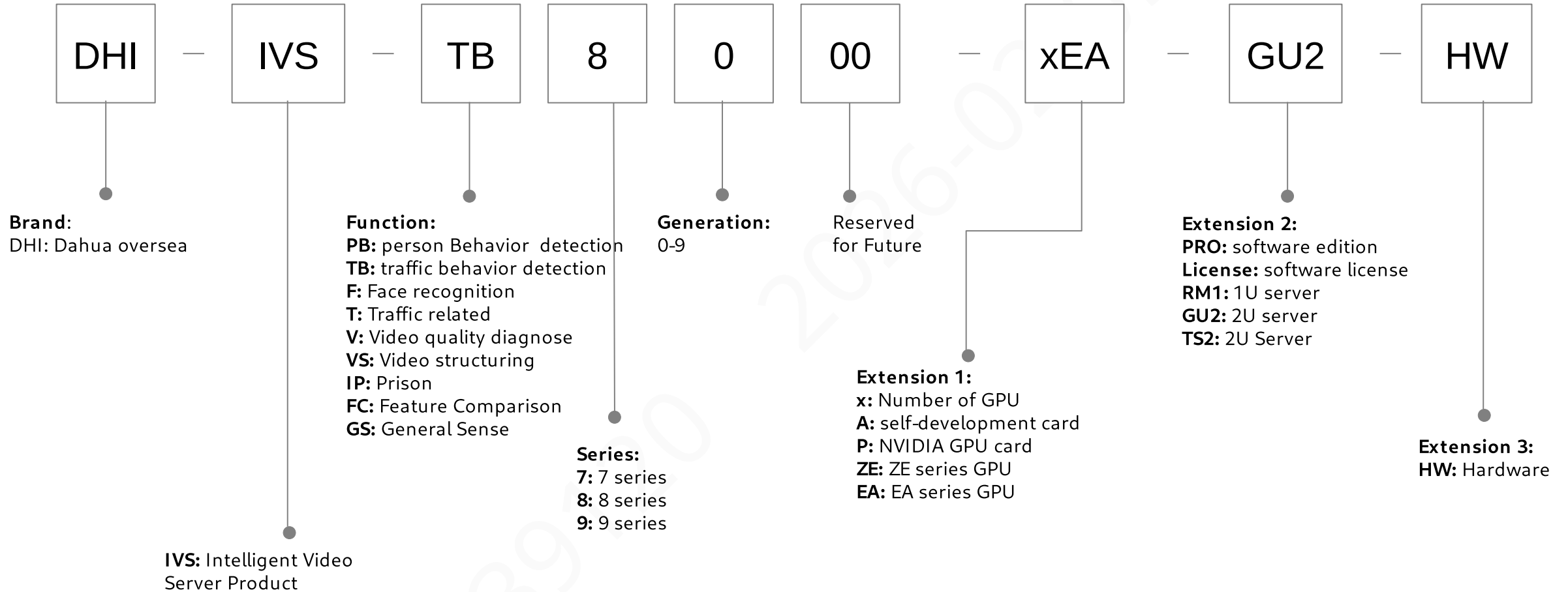

Switch

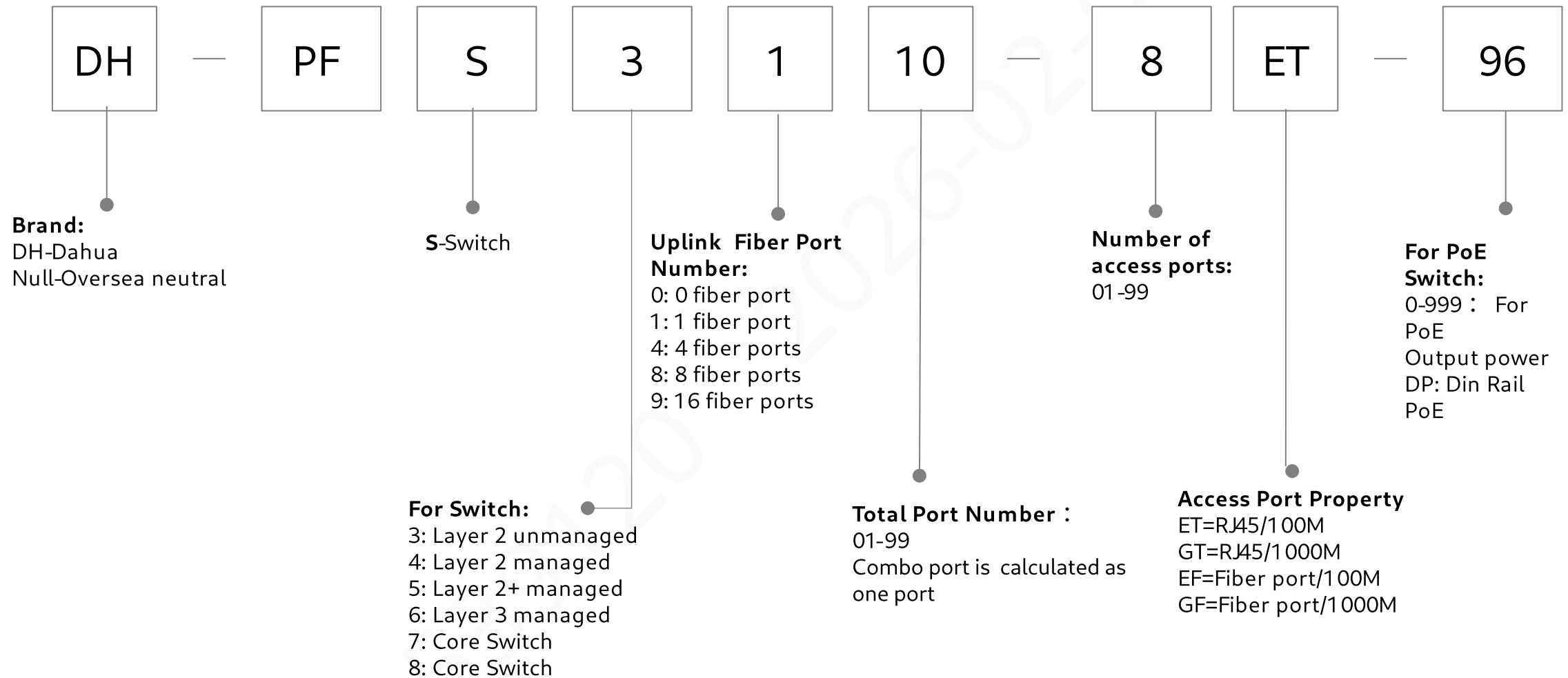

Switch(new,CCTV)

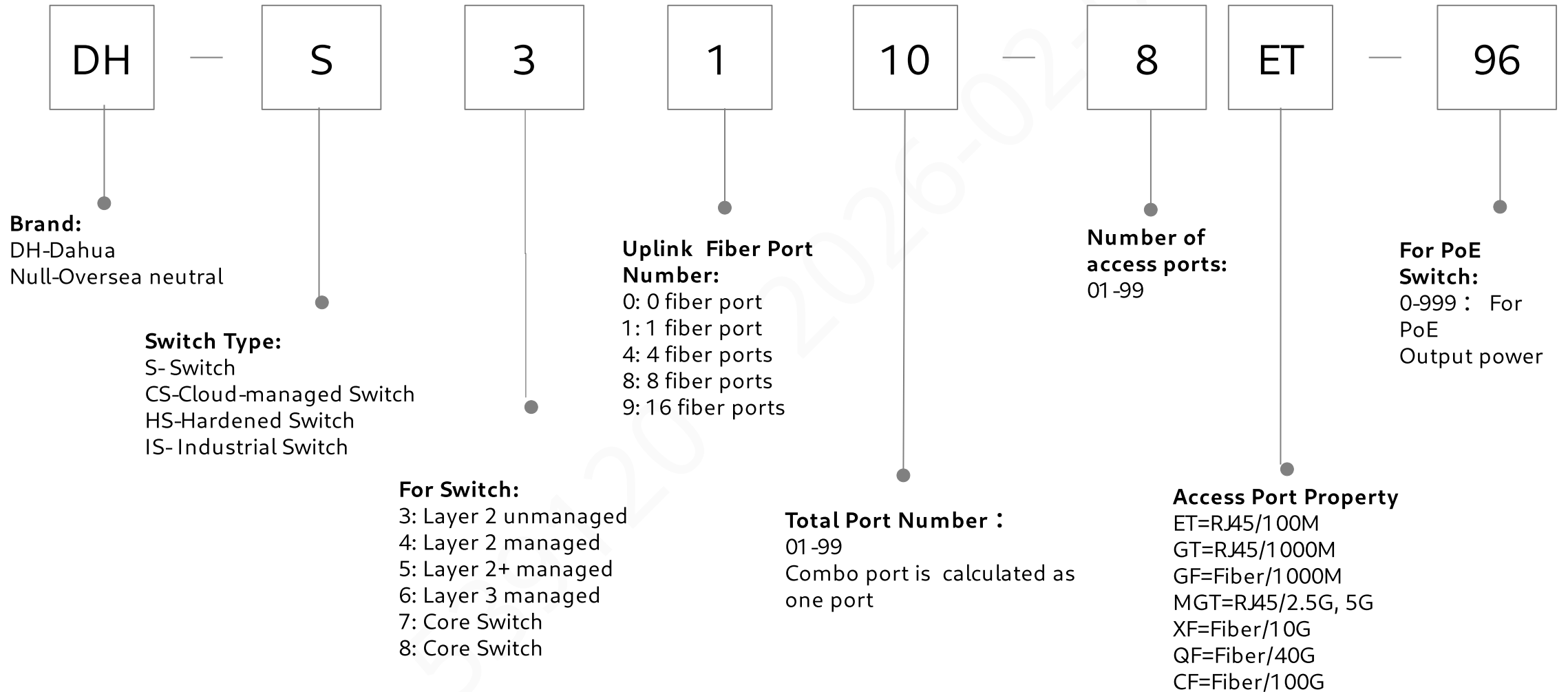

Switch(new, IT)

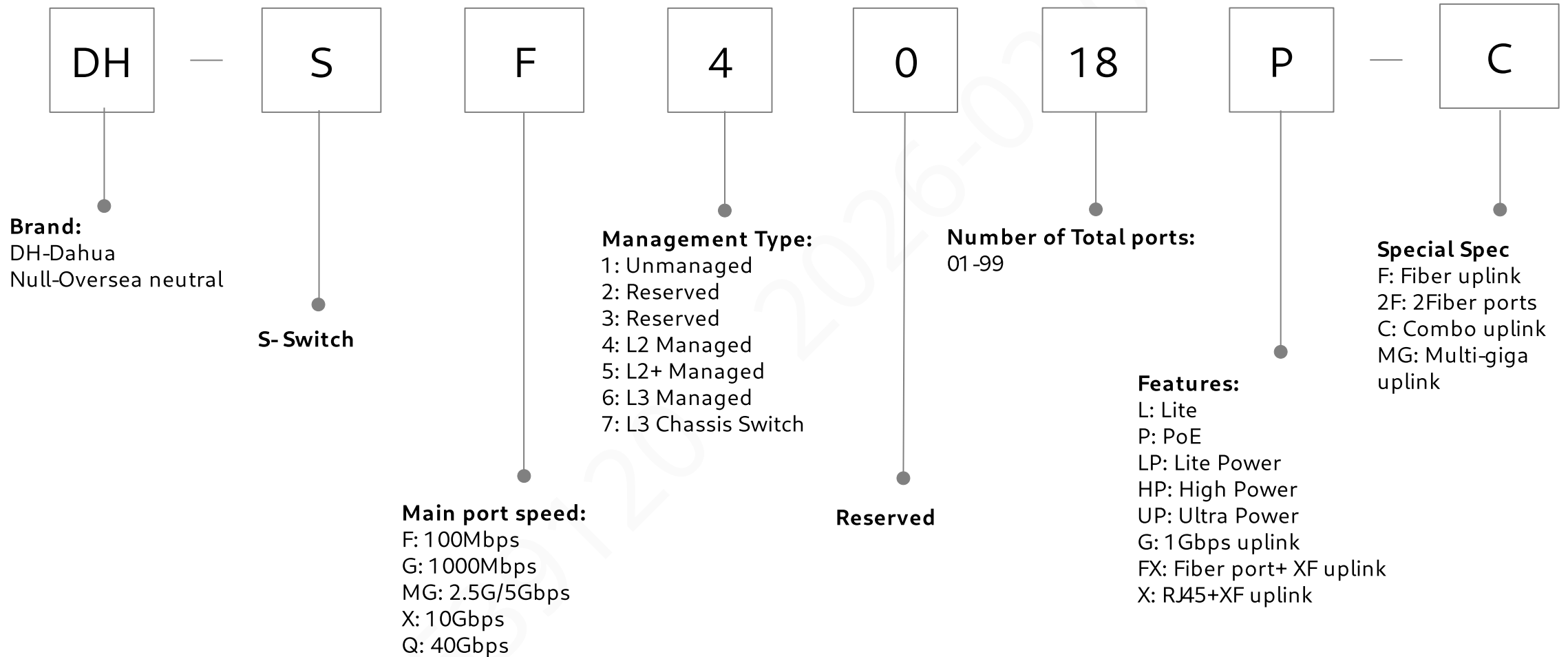

Wireless Router

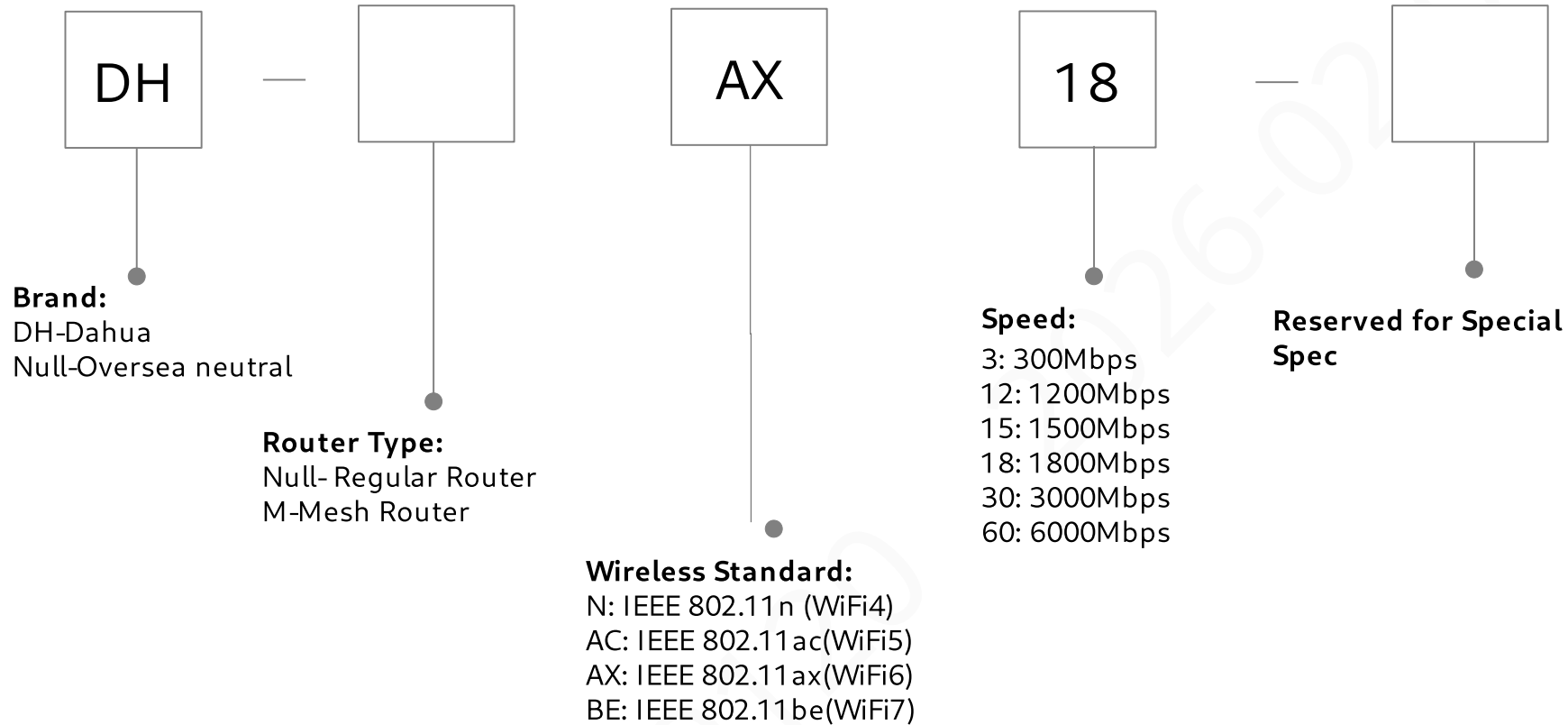

Wireless Bridge (Only for V-Radio series wireless bridge)

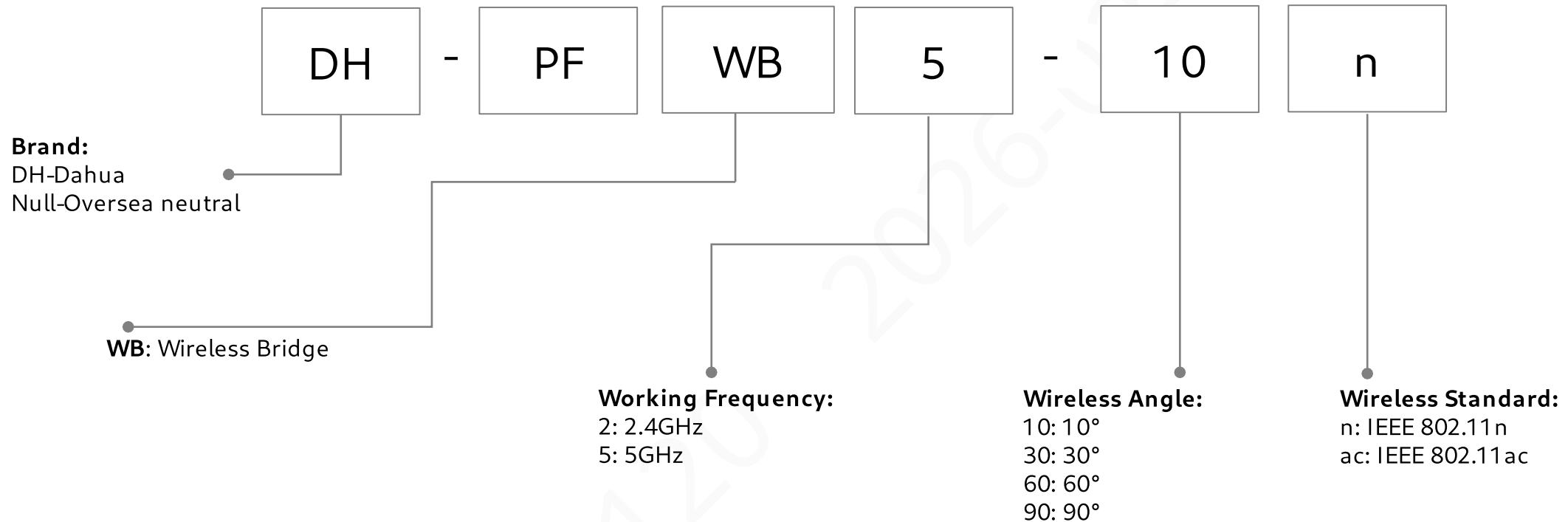

Wireless Bridge(new)

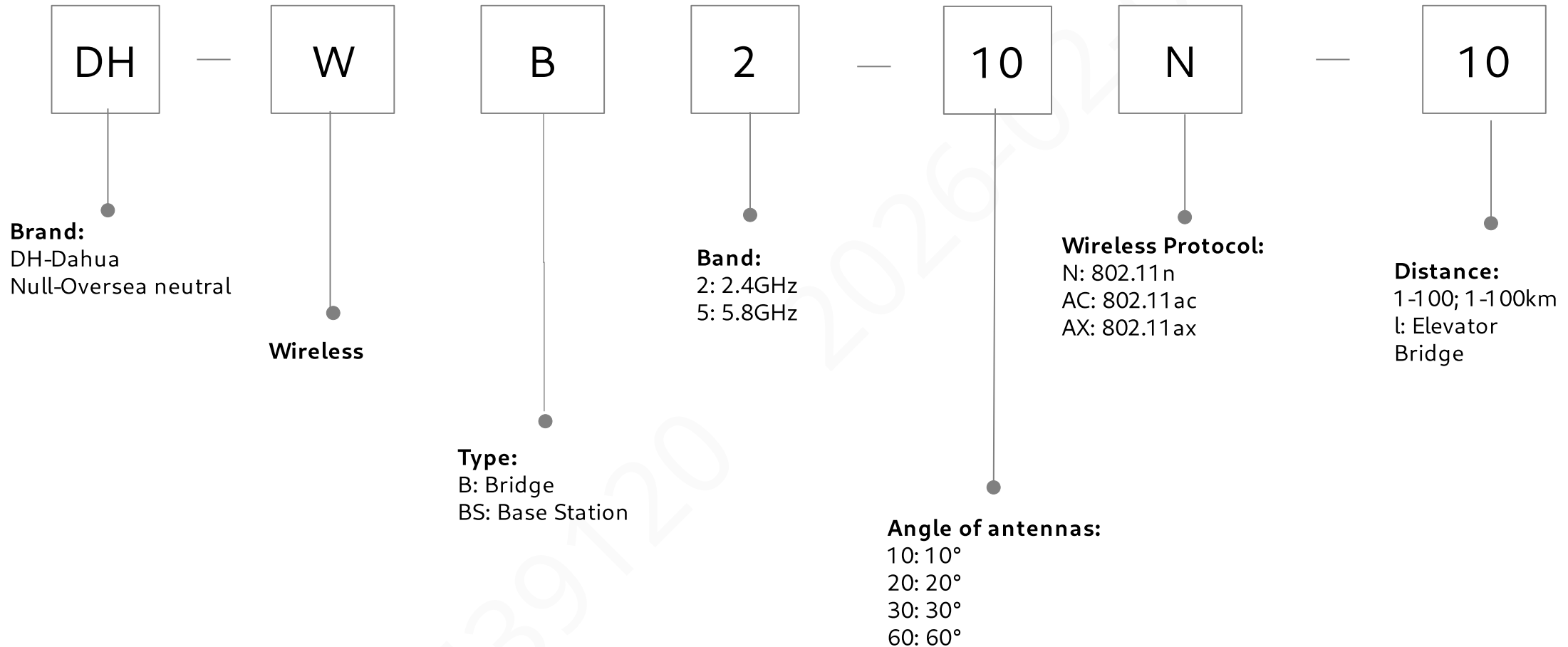

AP

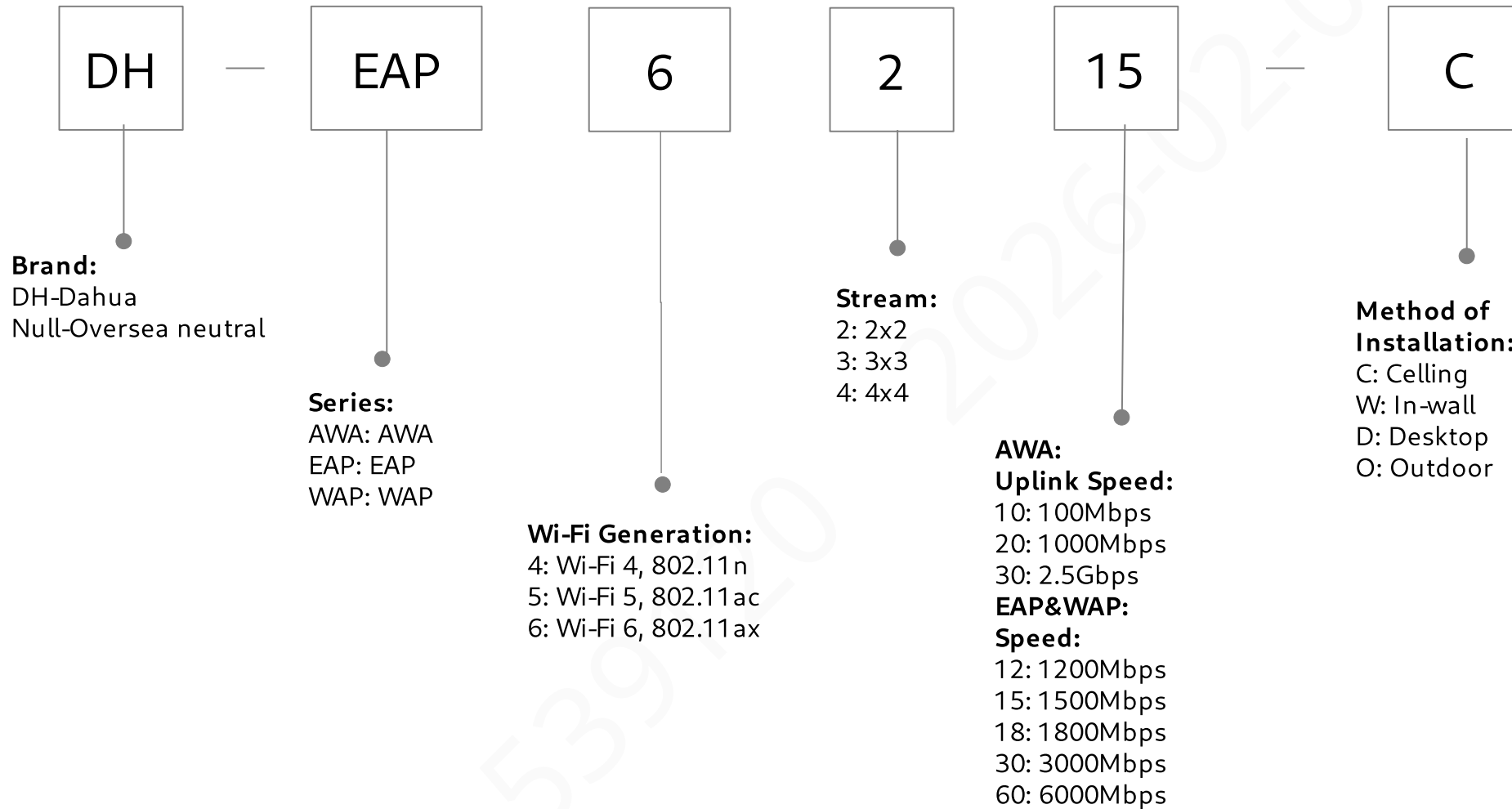

MPT

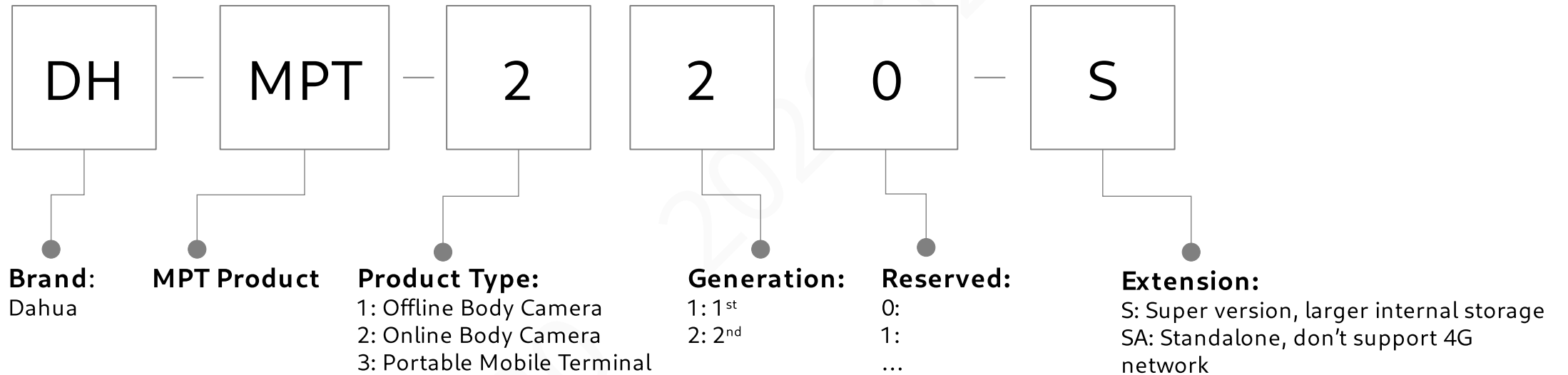

MPT

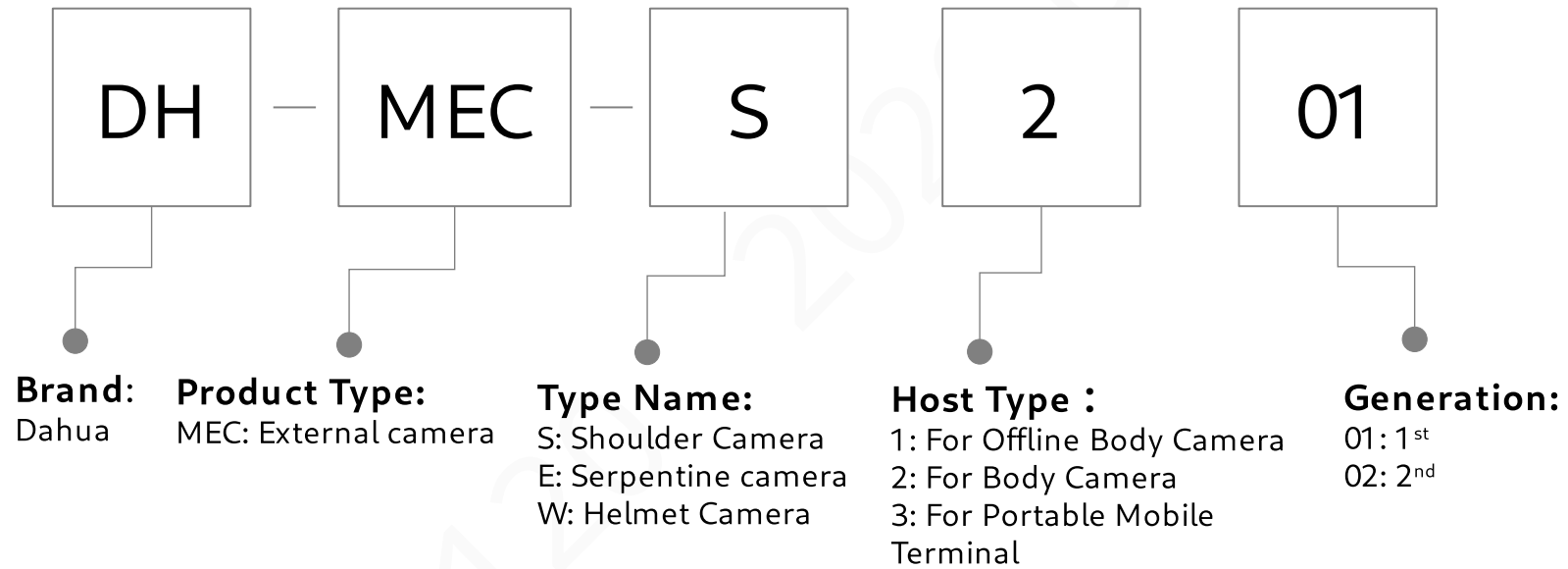

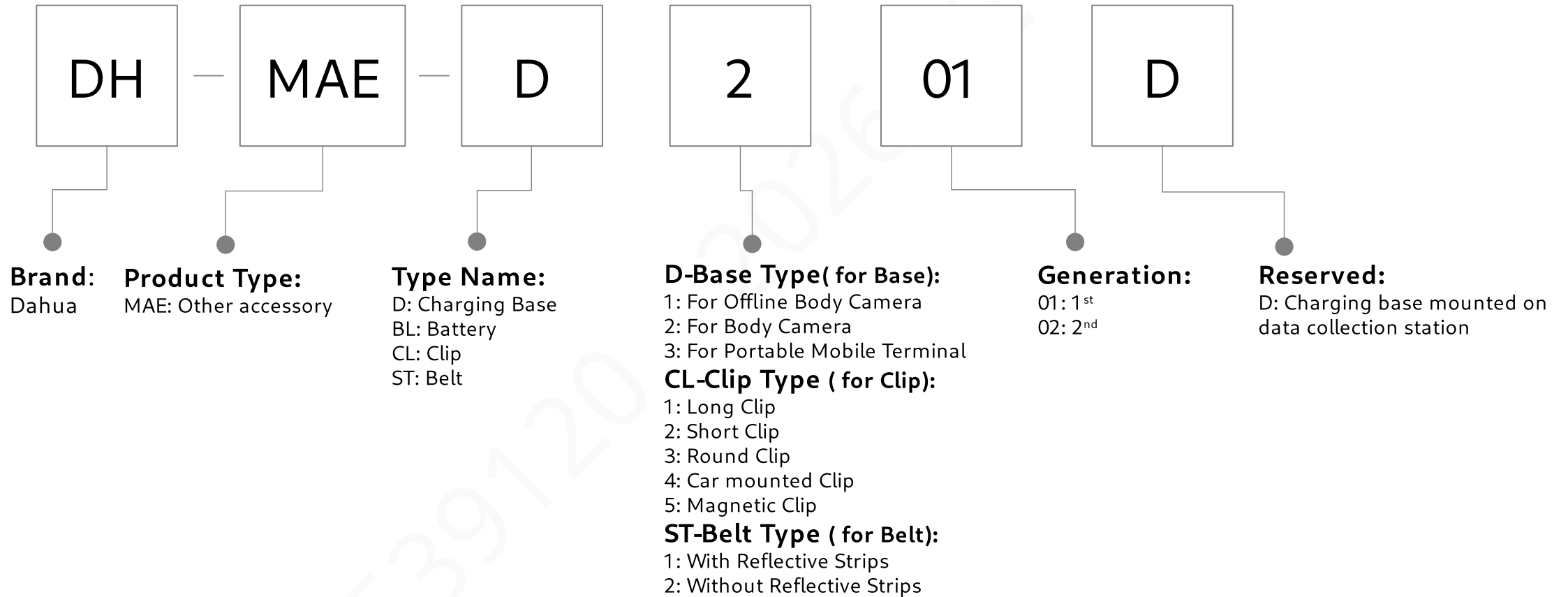

DSS Baseline

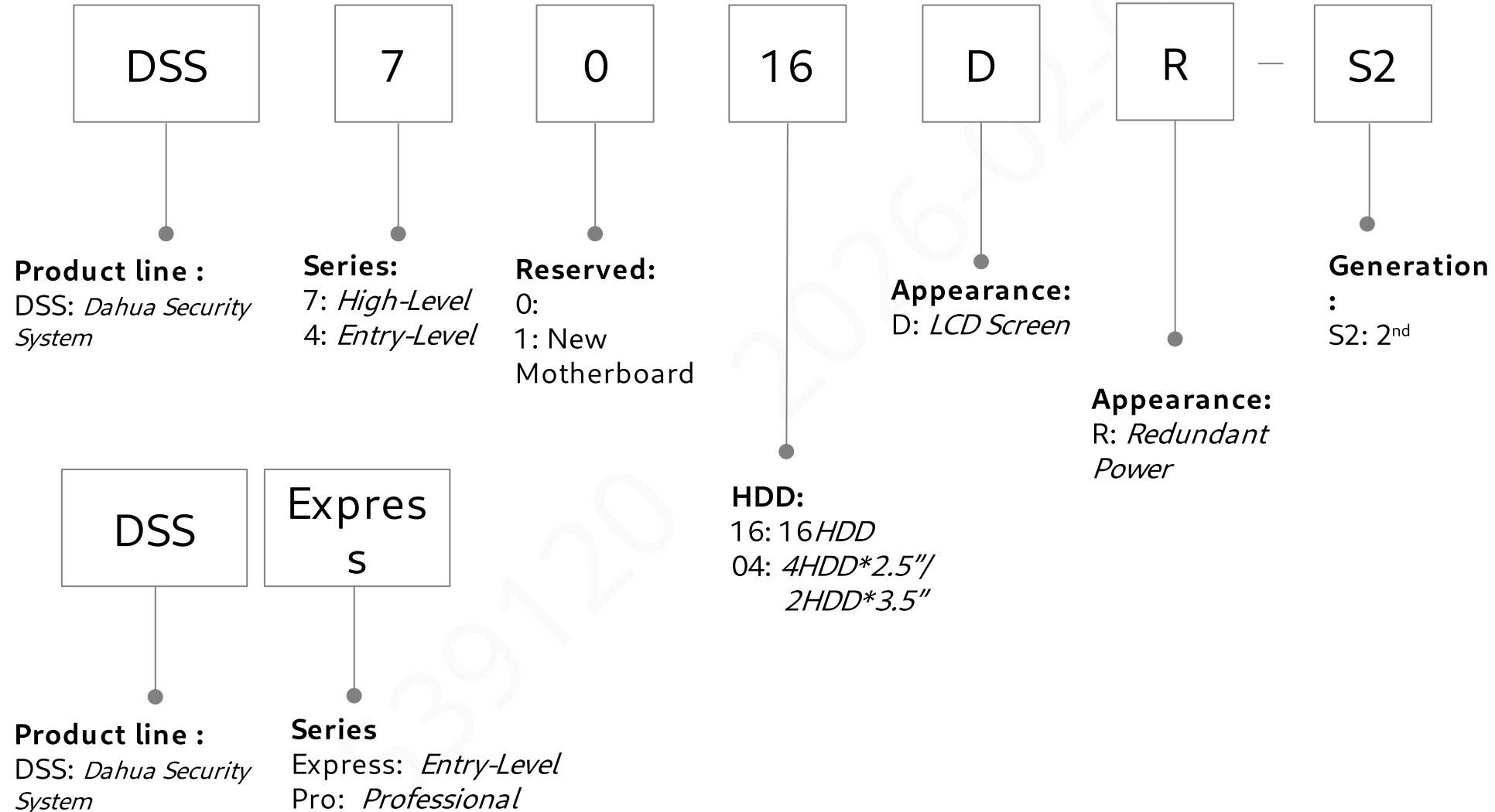

Video Intercom(Door Station)



Notice: The naming rule is applicable to the products released after 2016

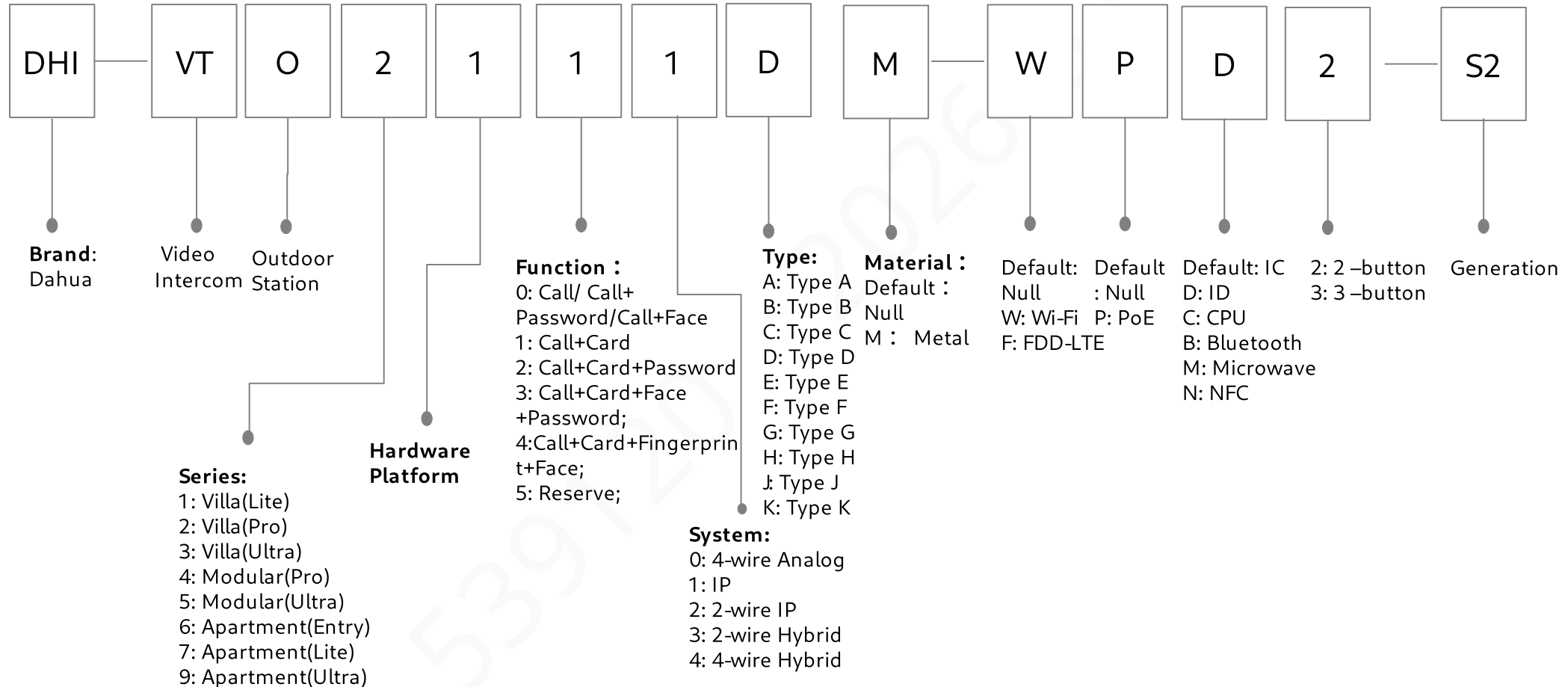

Video Intercom(Indoor Monitor)



Notice: The naming rule is applicable to the products released after 2016

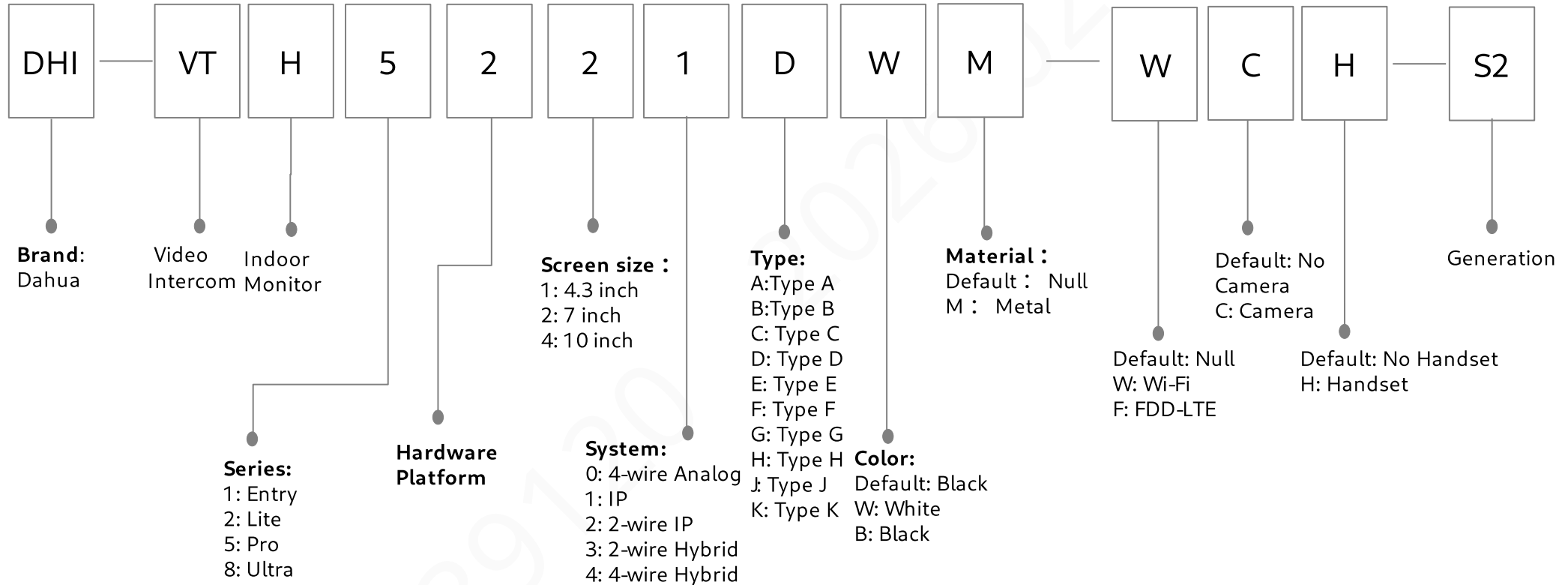

Video Intercom(SCP)

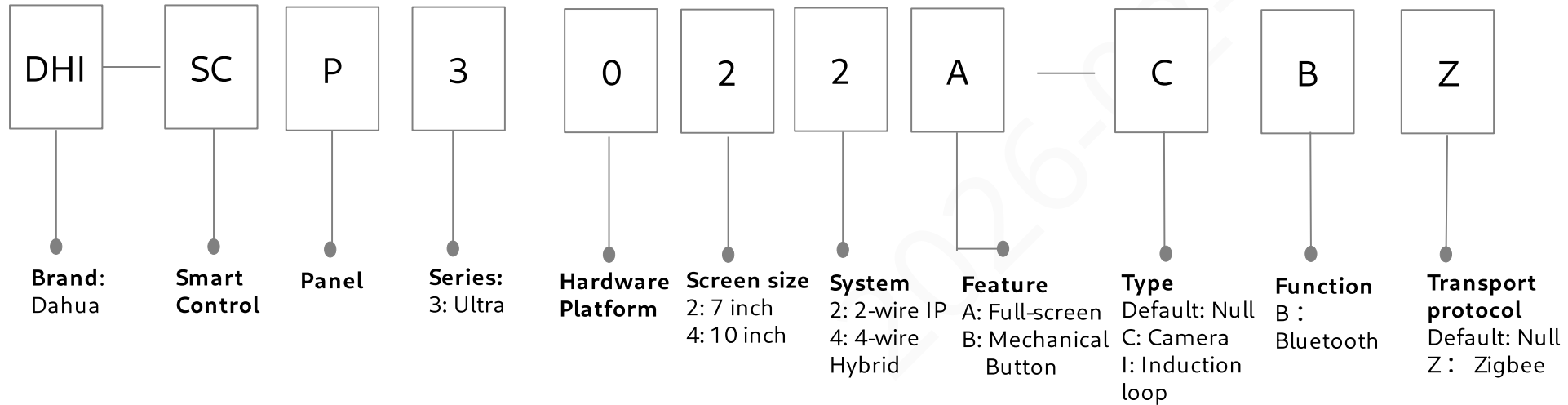

Video Intercom(Video Doorbell & Chime)

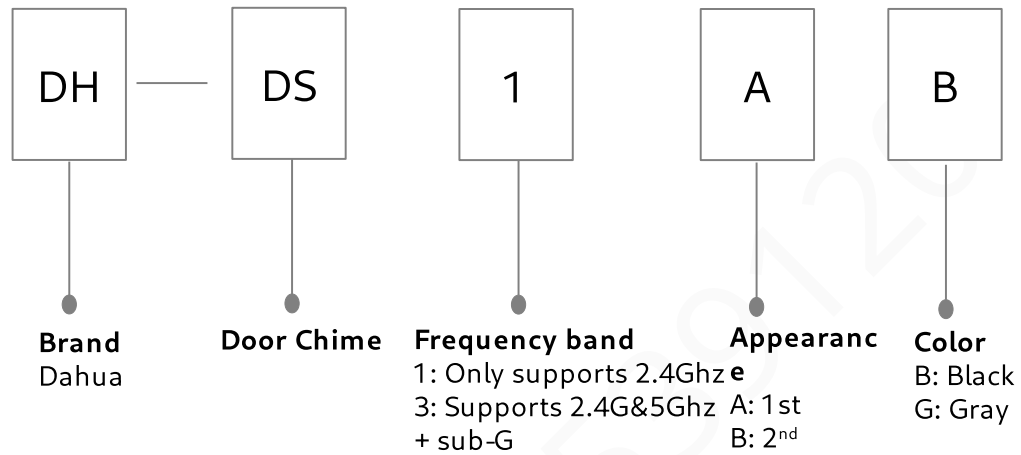
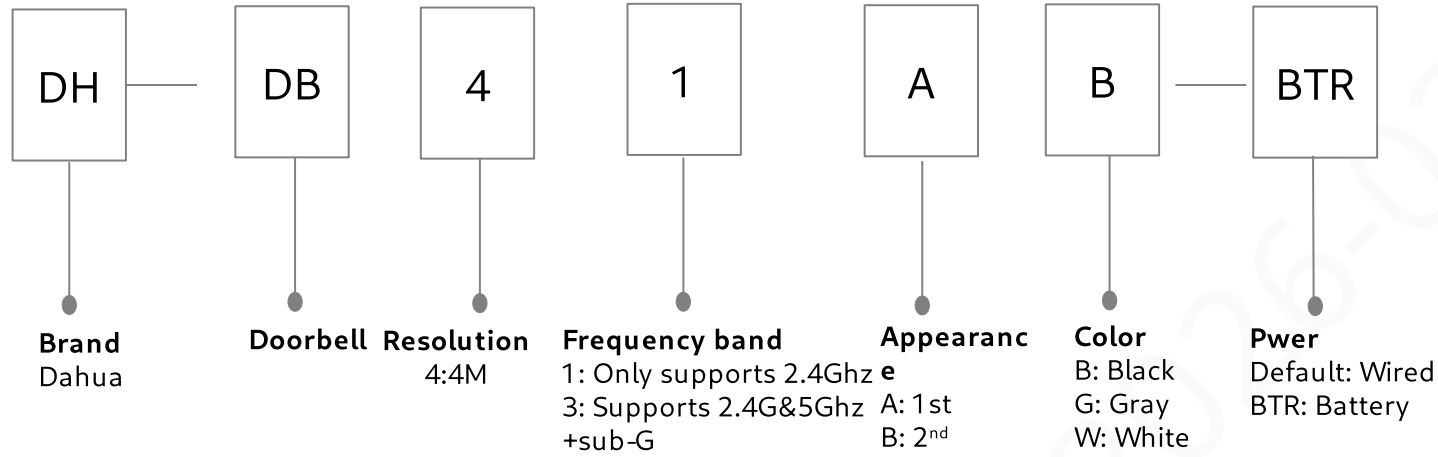

Video Intercom(KIT)

Notice: The naming rule is applicable to the products released after 2019

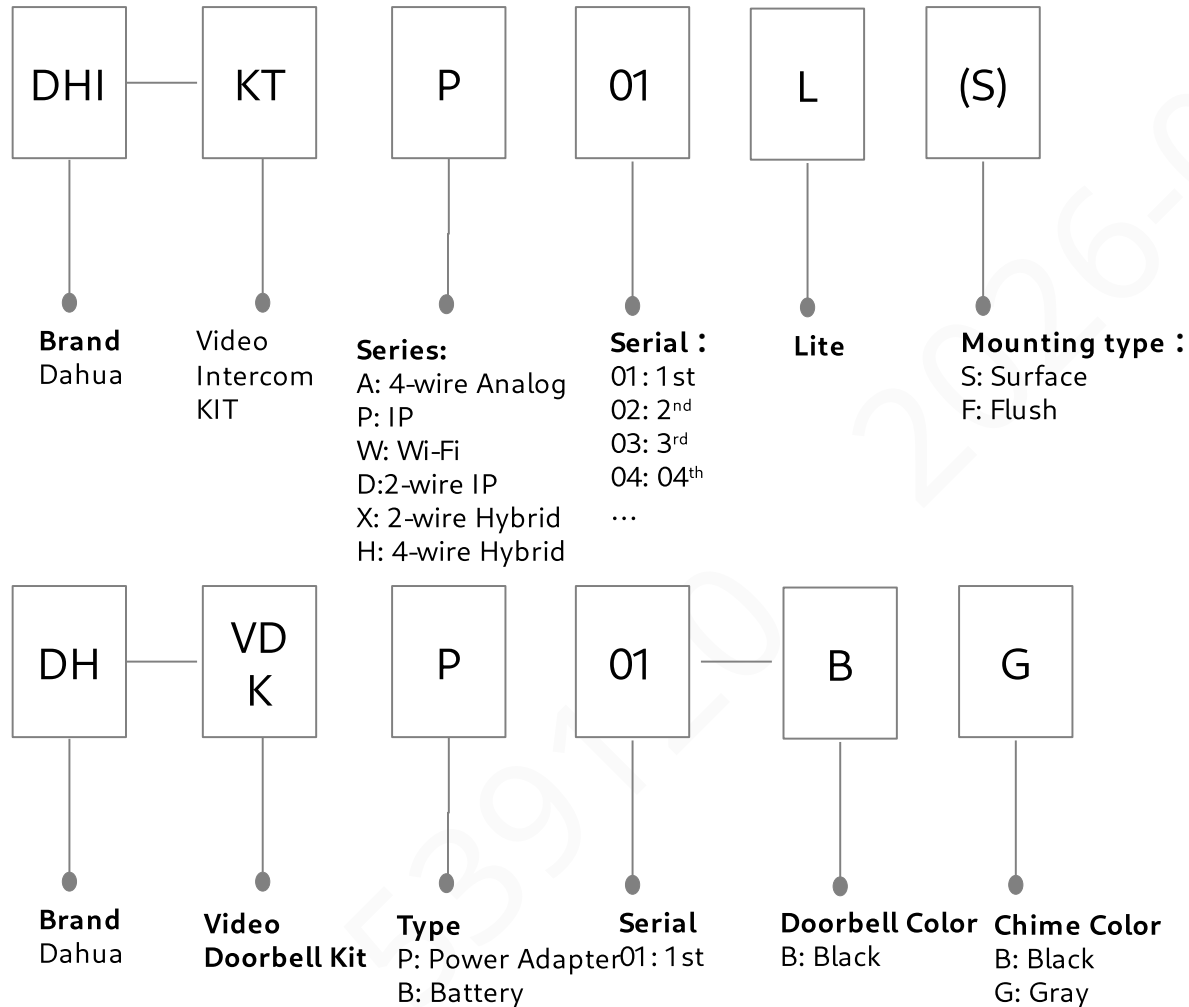

Video Intercom(Emergency Phone Terminals)

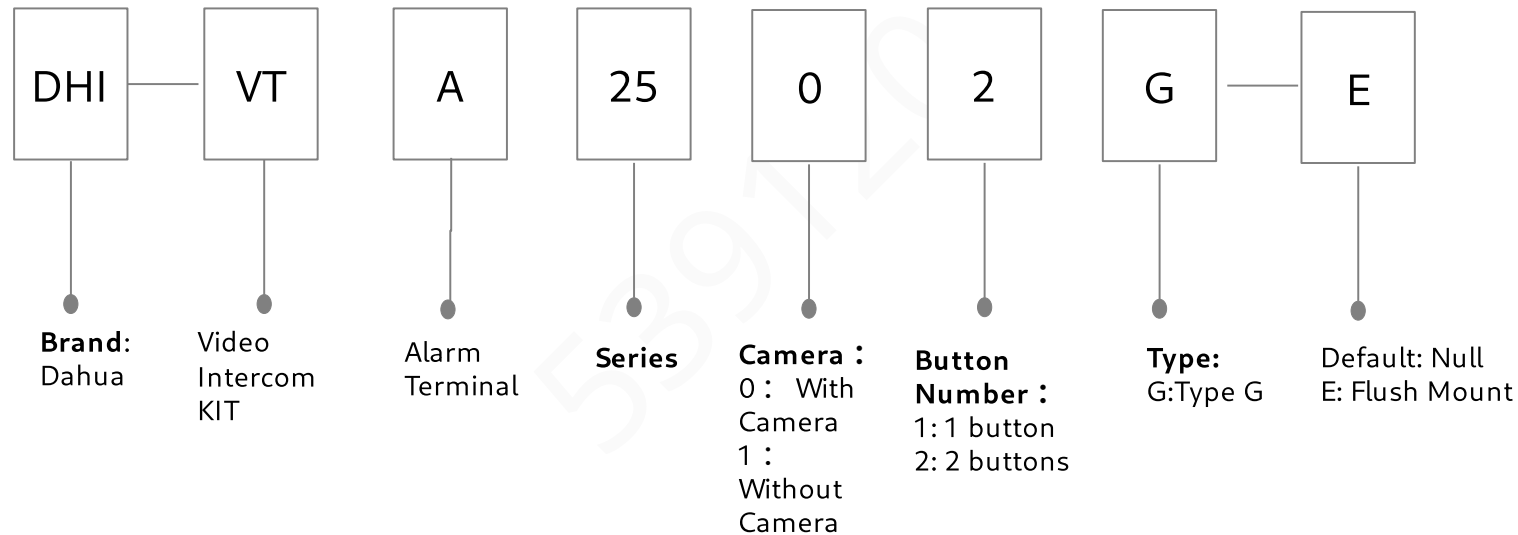
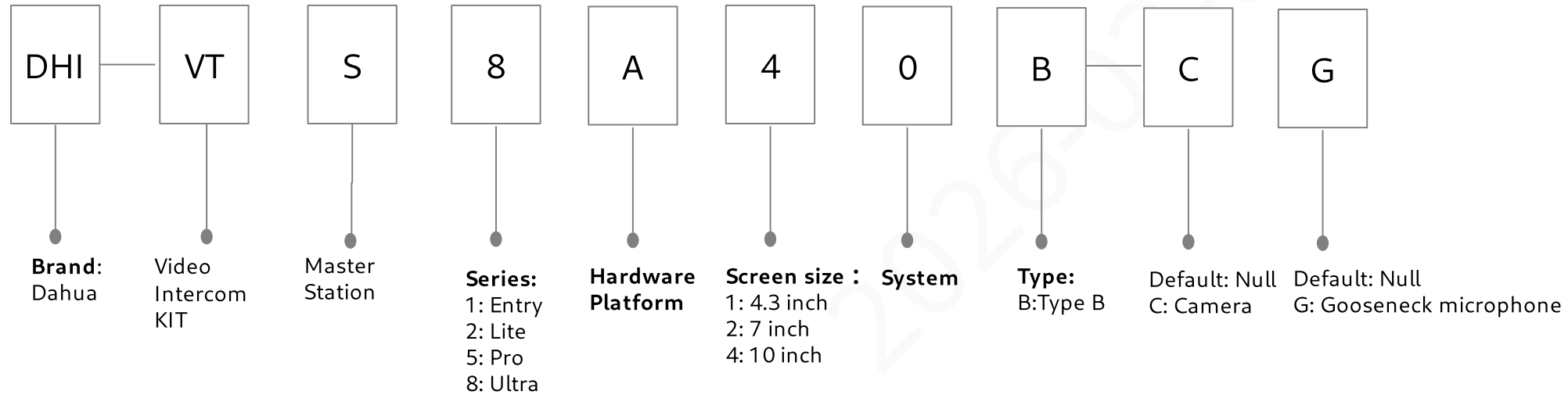

Video Intercom(Accessory)

Notice: The naming rule is applicable to the products released after 2021

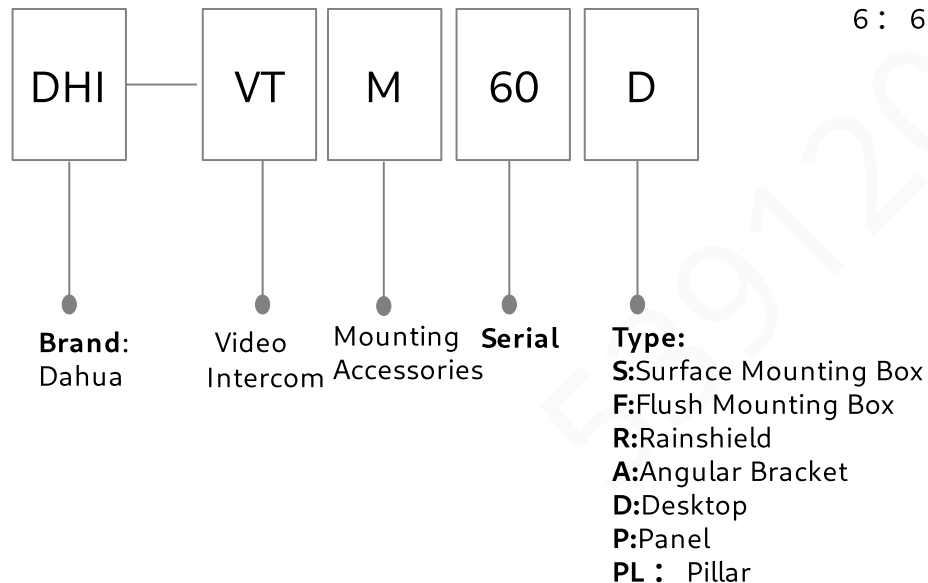
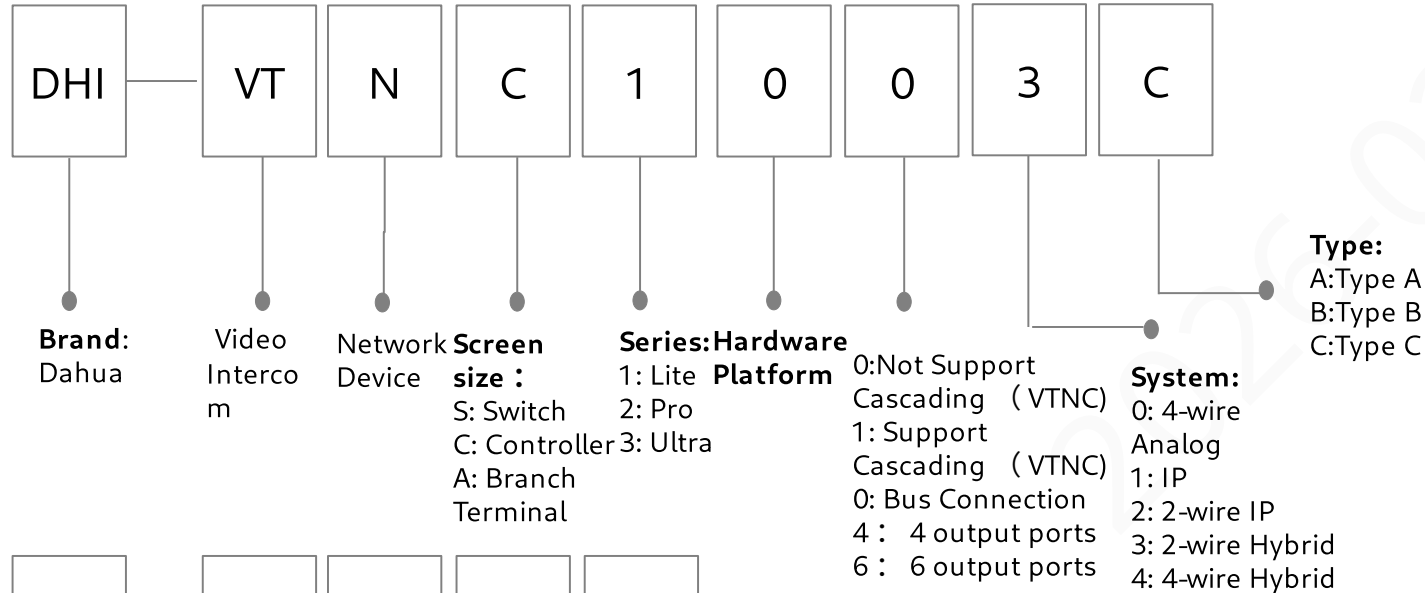

Access Control (Integrated)

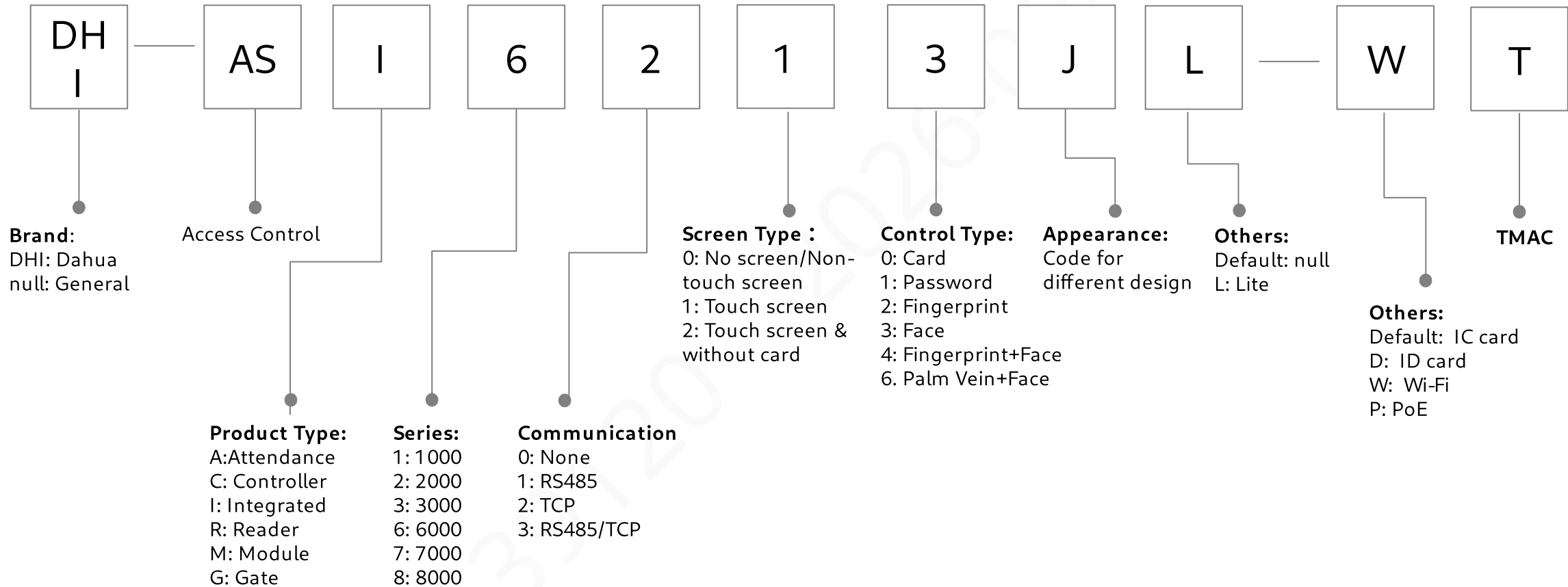

Access Control (Controller)

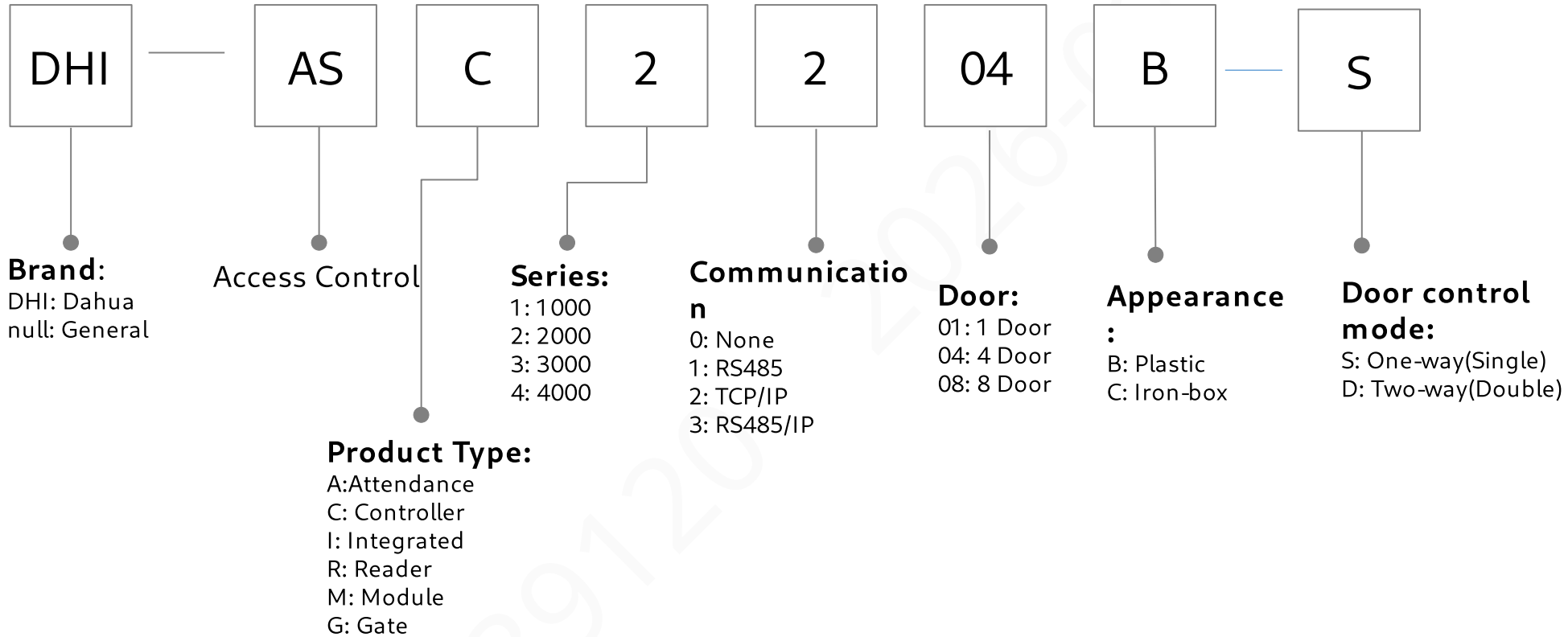

Access Control (Reader)

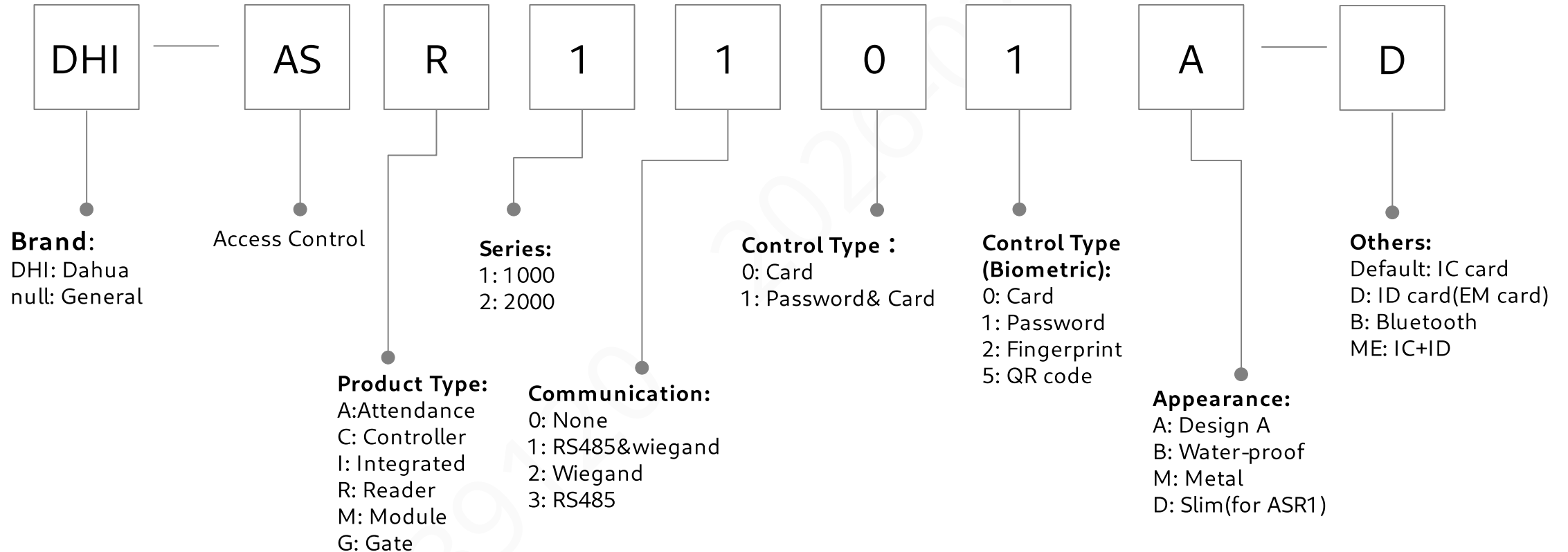

Access Control (Module)

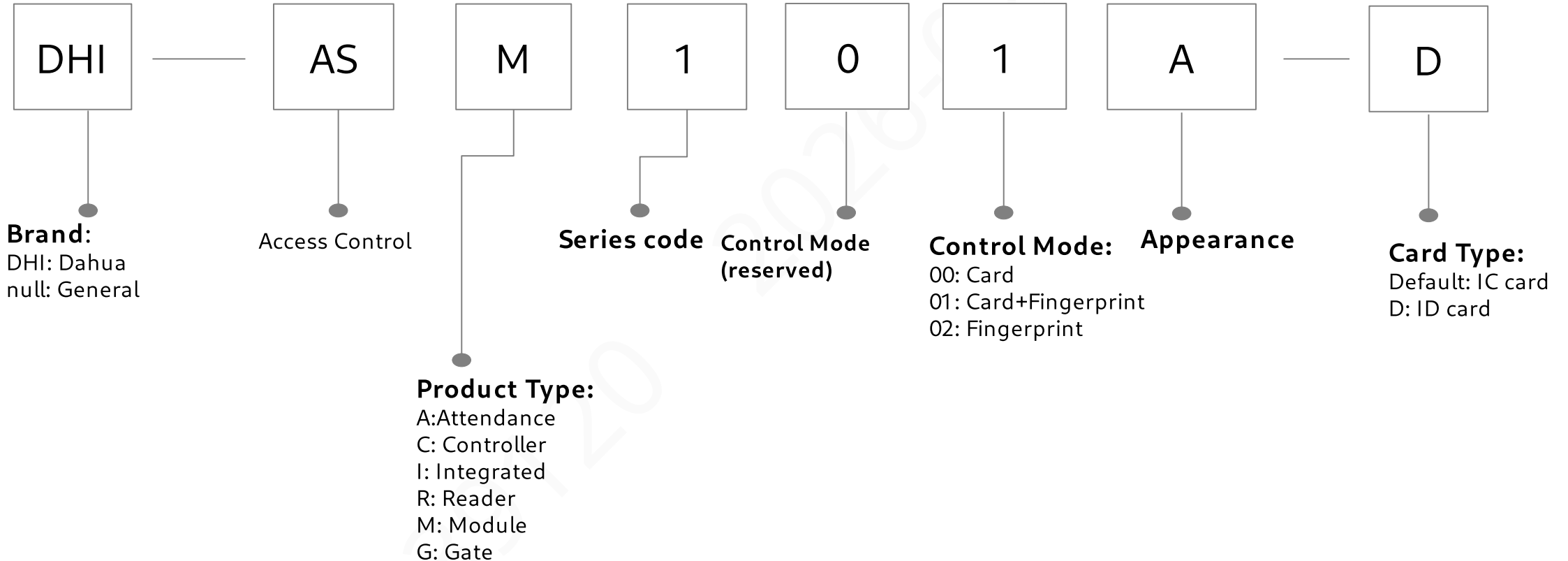

Access Control (Attendance)

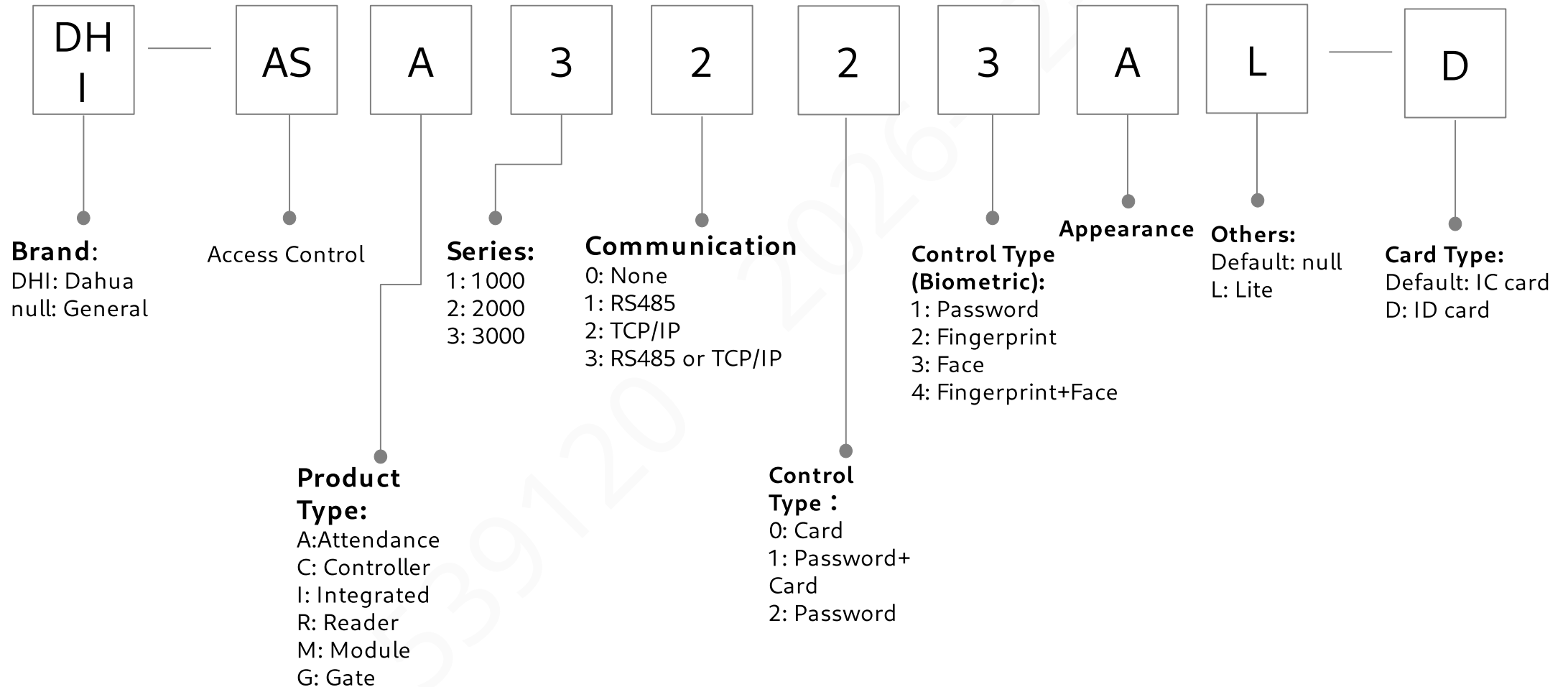

Access Control (Turnstile)

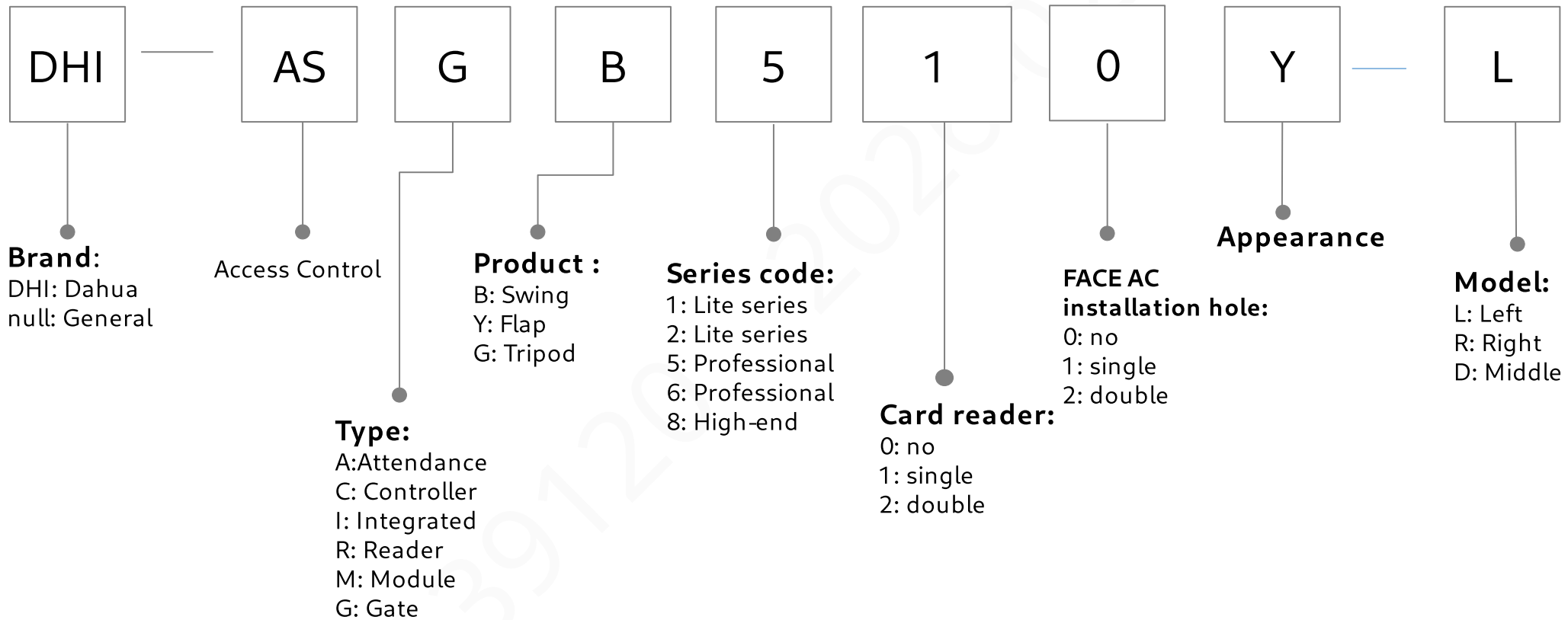

Alarm (Controller)

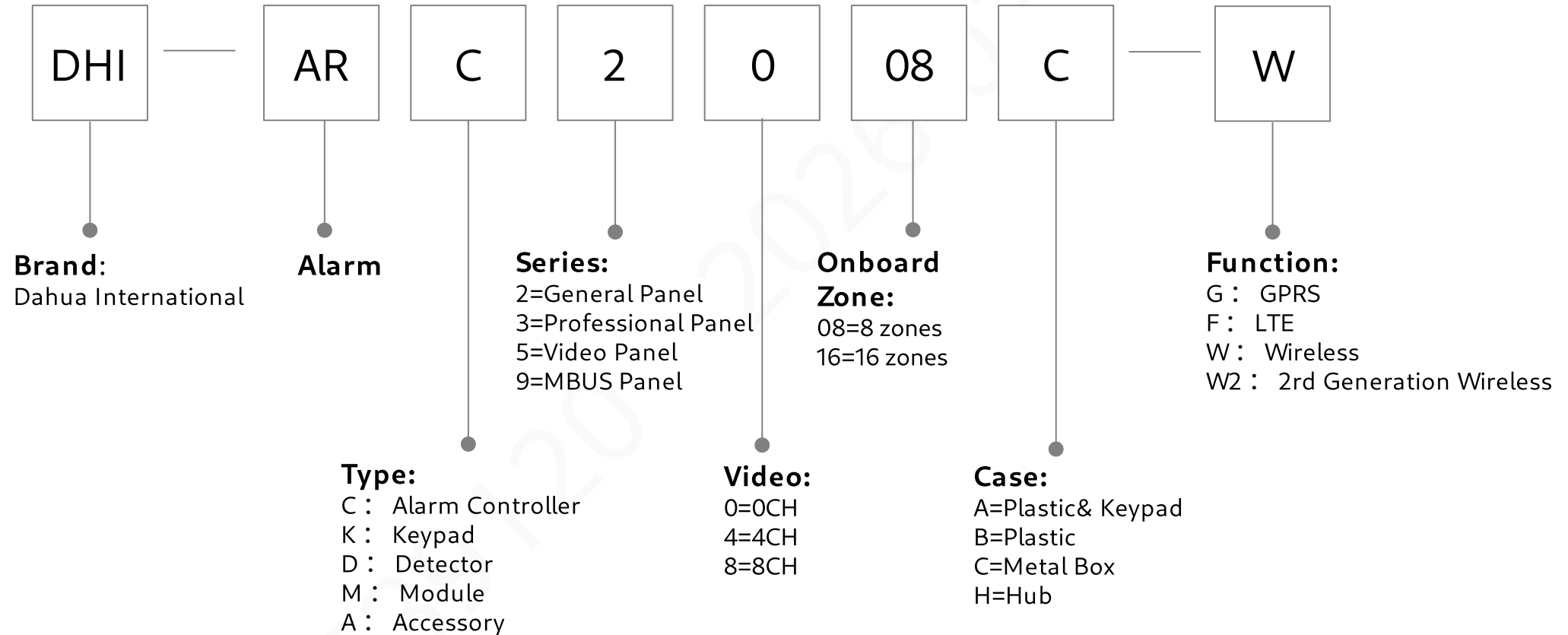

Alarm (Keypad & Module)

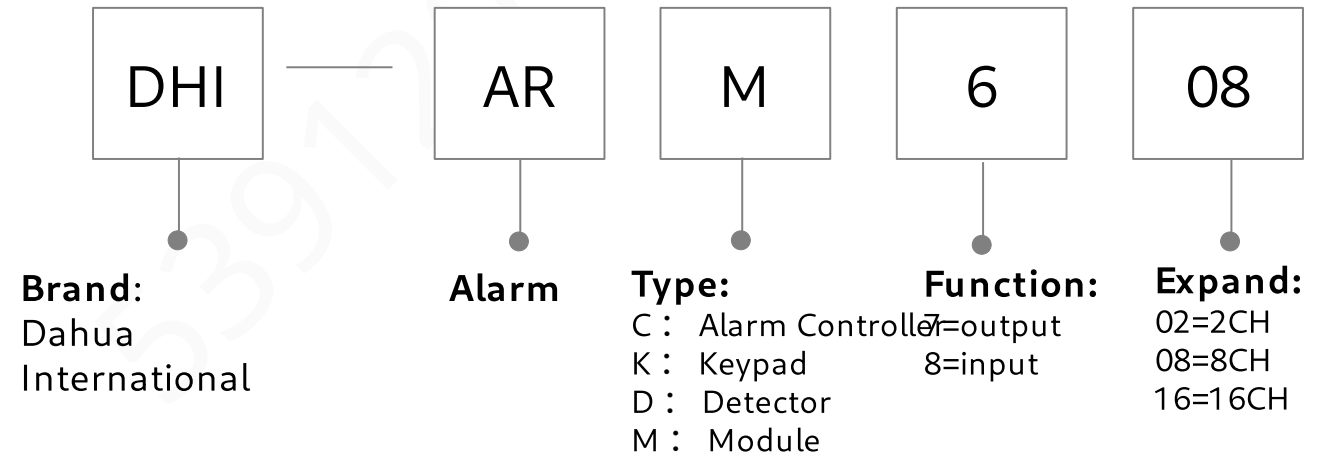
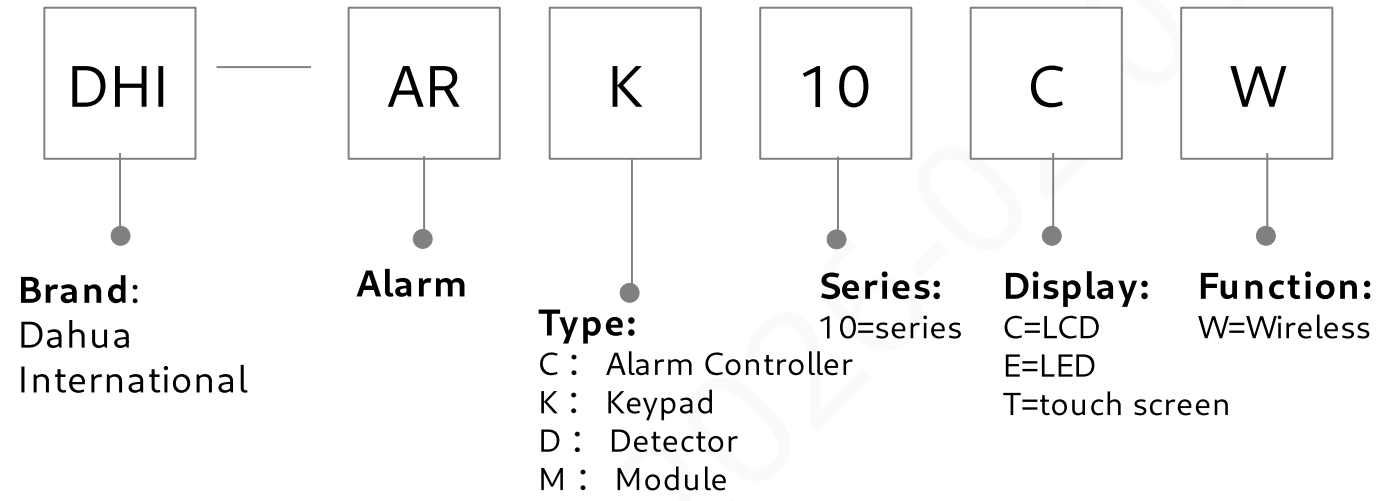

ITS-Traffic Camera

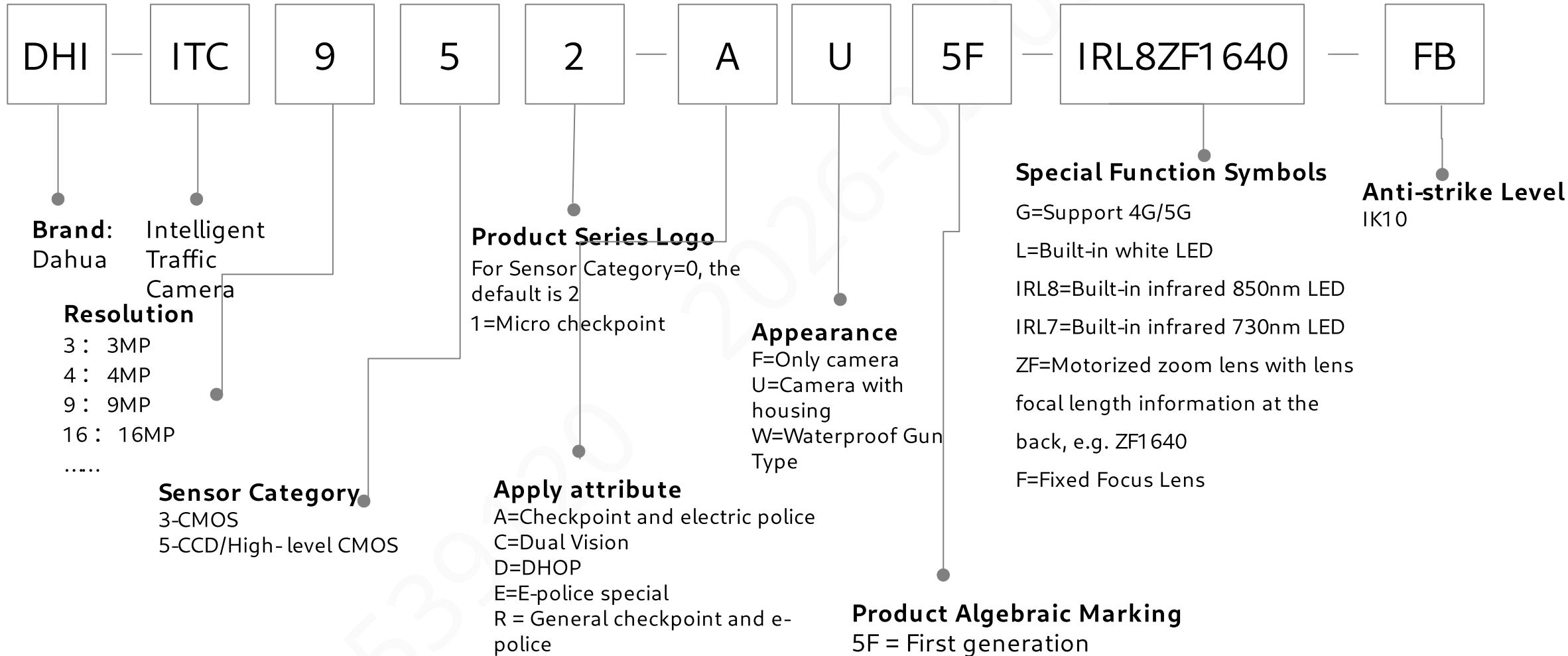

ITS-Traffic Camera-Spotter sky



Brand
Dahua

Intelligent Traffic Camera

Resolution

9: 9MP
16: 16MP
.....

Sensor Category

3=CMOS
5=CCD/High-level CMOS

Last =5, default: 2
Last =3, default: 1

Generation of Platform

1st generation =SU1F
2nd generation =SU2F

Expand function

G= 4G
P=PRO New Appearance (Non-4G)

The last two:
QE : Checkpoint & E-police
TE : Traffic Event

Hardware:

C: Version of platform
C1=Amba platform
C2=Faraday platform
R: Radar
R0=No radar
R1=ST radar (77Ghz)

Special Function Symbols

L=Built-in white LED
IRL8=Built-in infrared 850nm LED
IRL7=Built-in infrared 730nm LED
ZF=Motorized zoom lens with lens focal length information at the back, e.g. ZF1 640
F=Fixed Focus Lens

ITS-Traffic Edge Storage (ITSE)

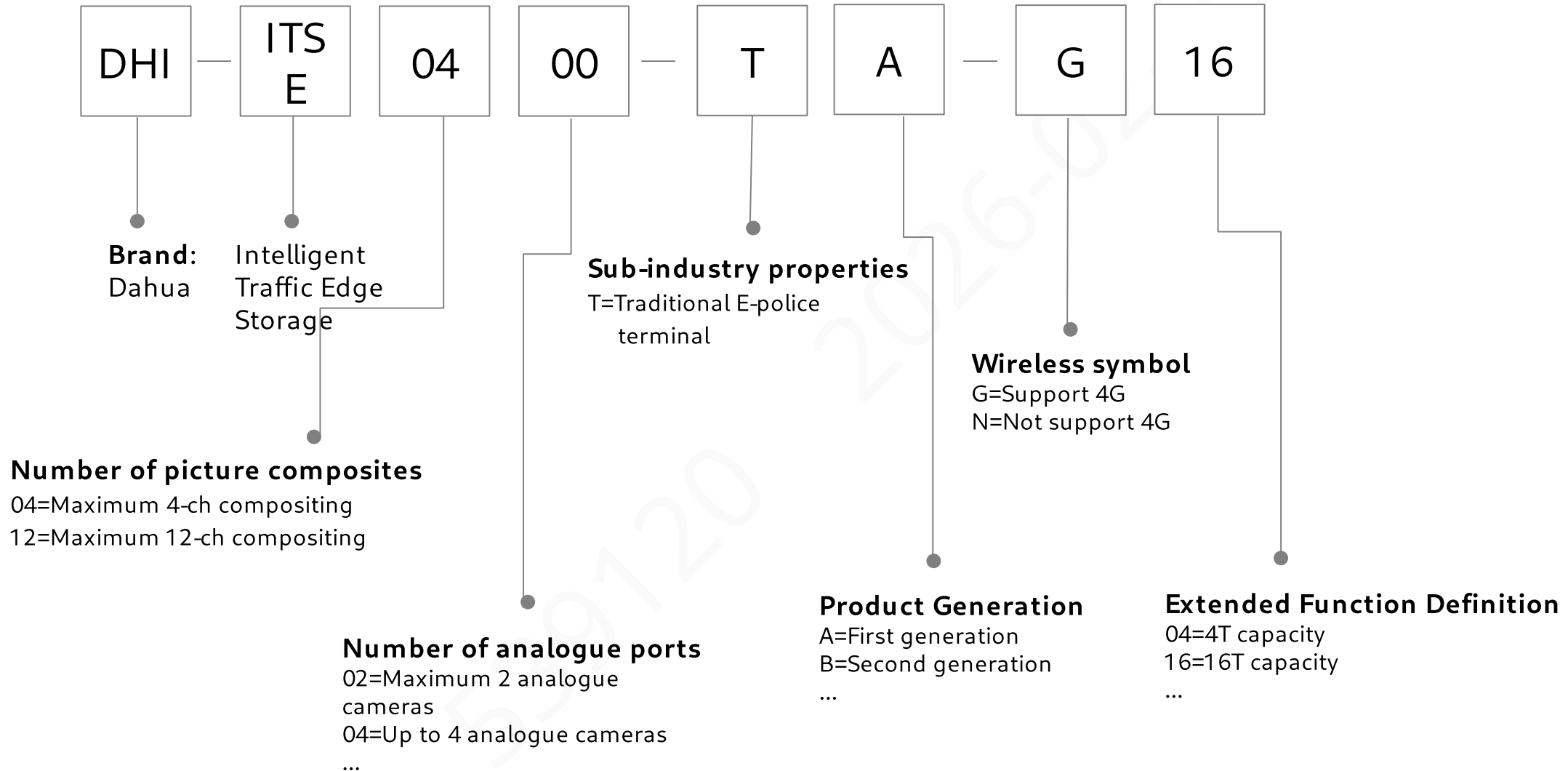

ITS-Traffic Lamp

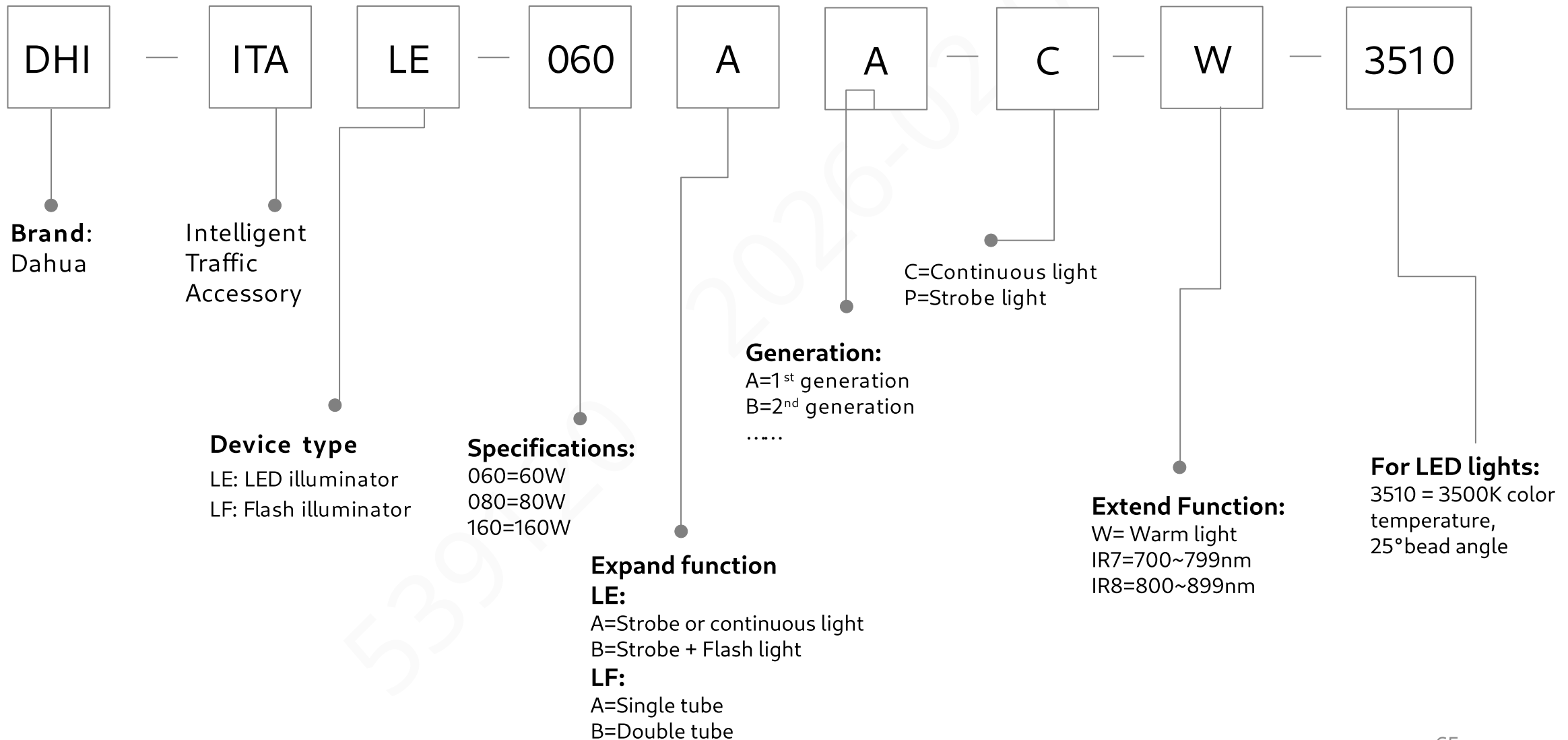

ITS-Traffic Radar

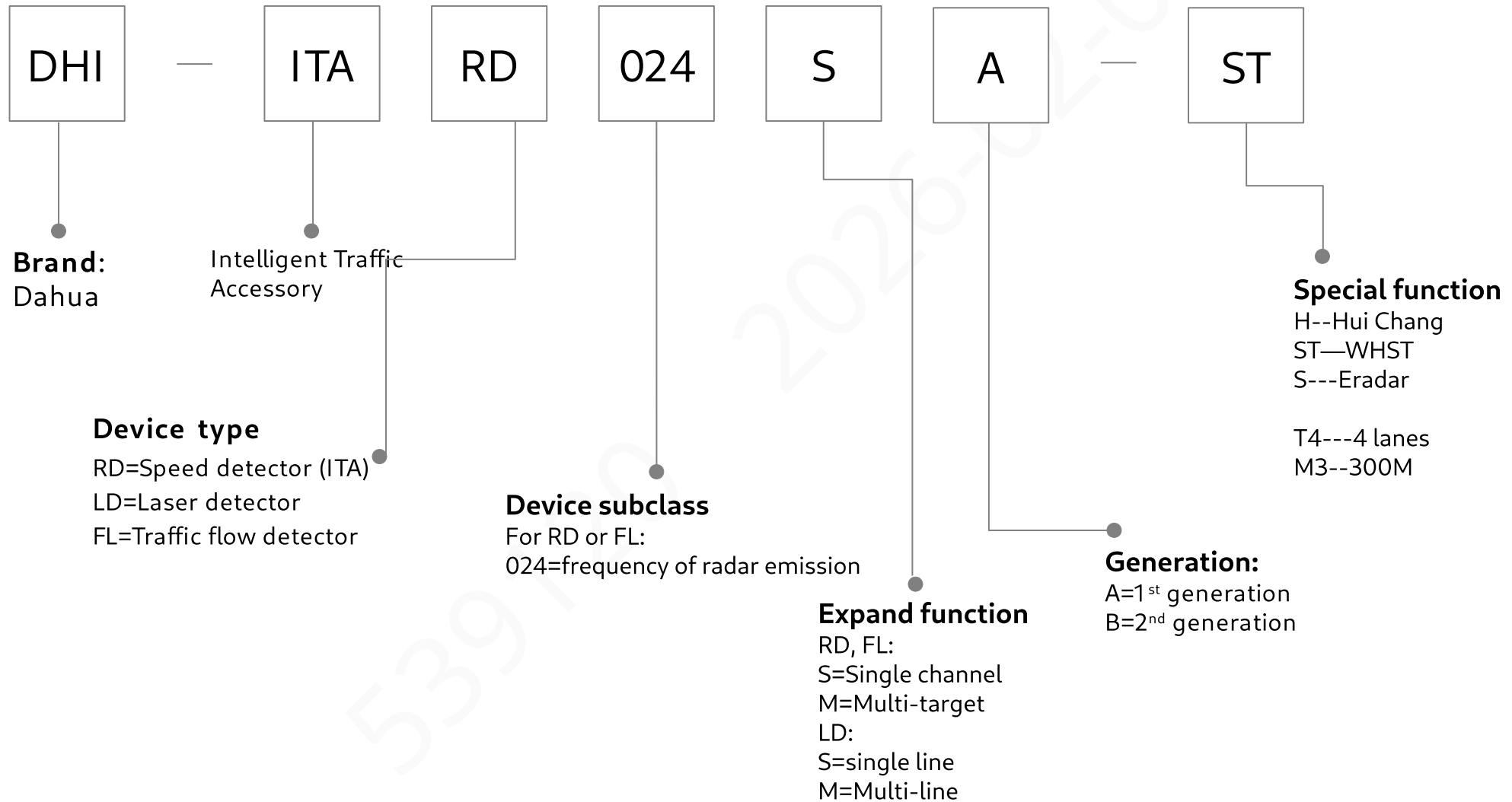

ITS-Traffic Signal Controller

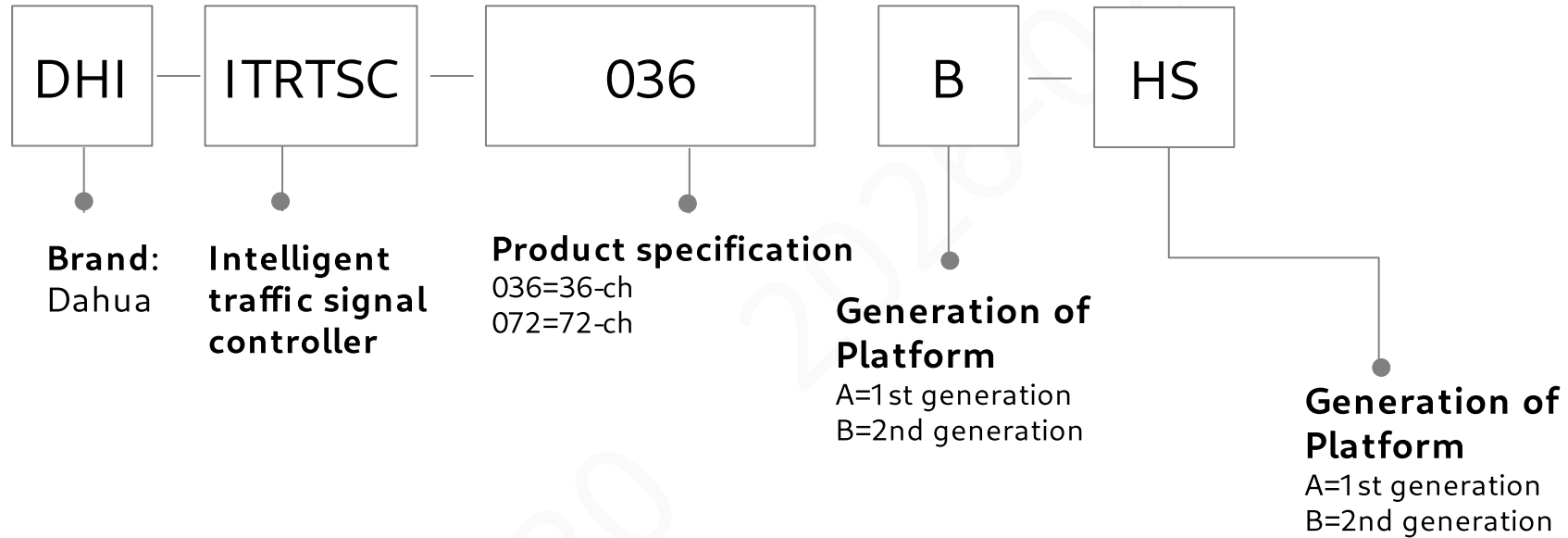

ITS-Speed Measuring System

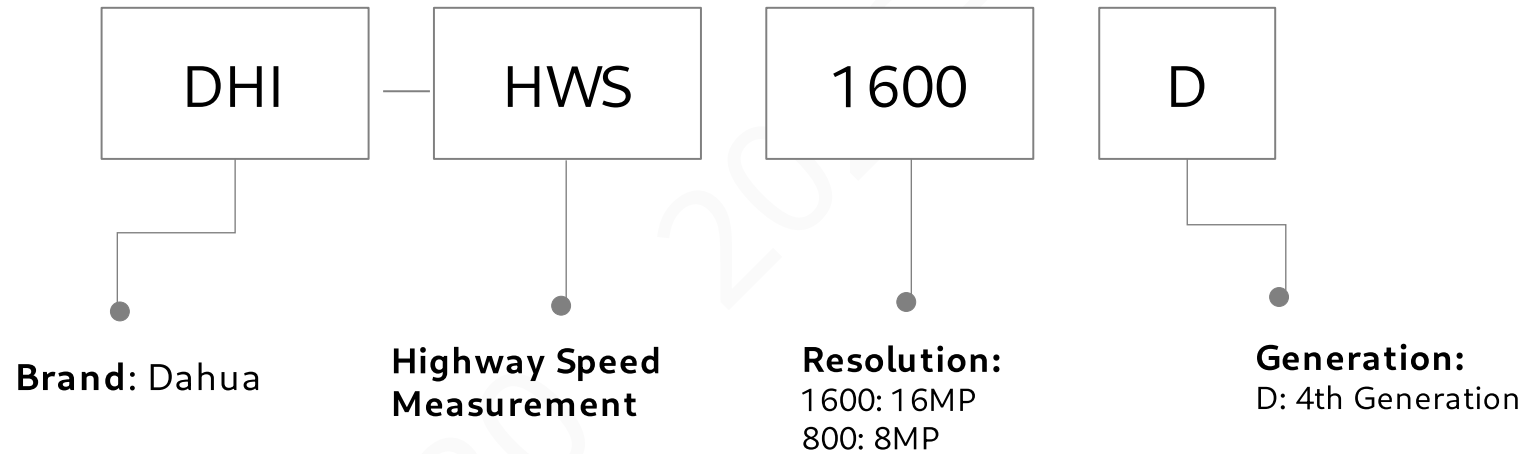

ITS-Access ANPR Camera

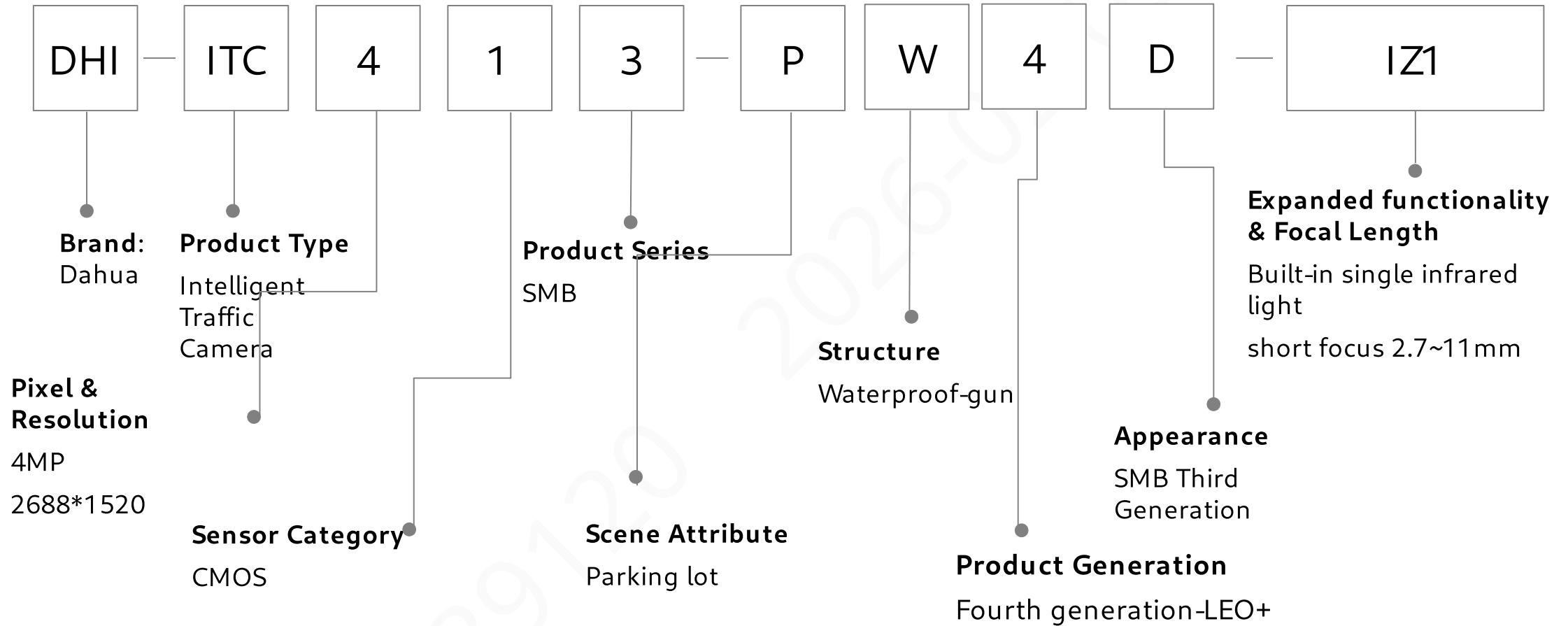

ITS-4MP Spot Detection Camera

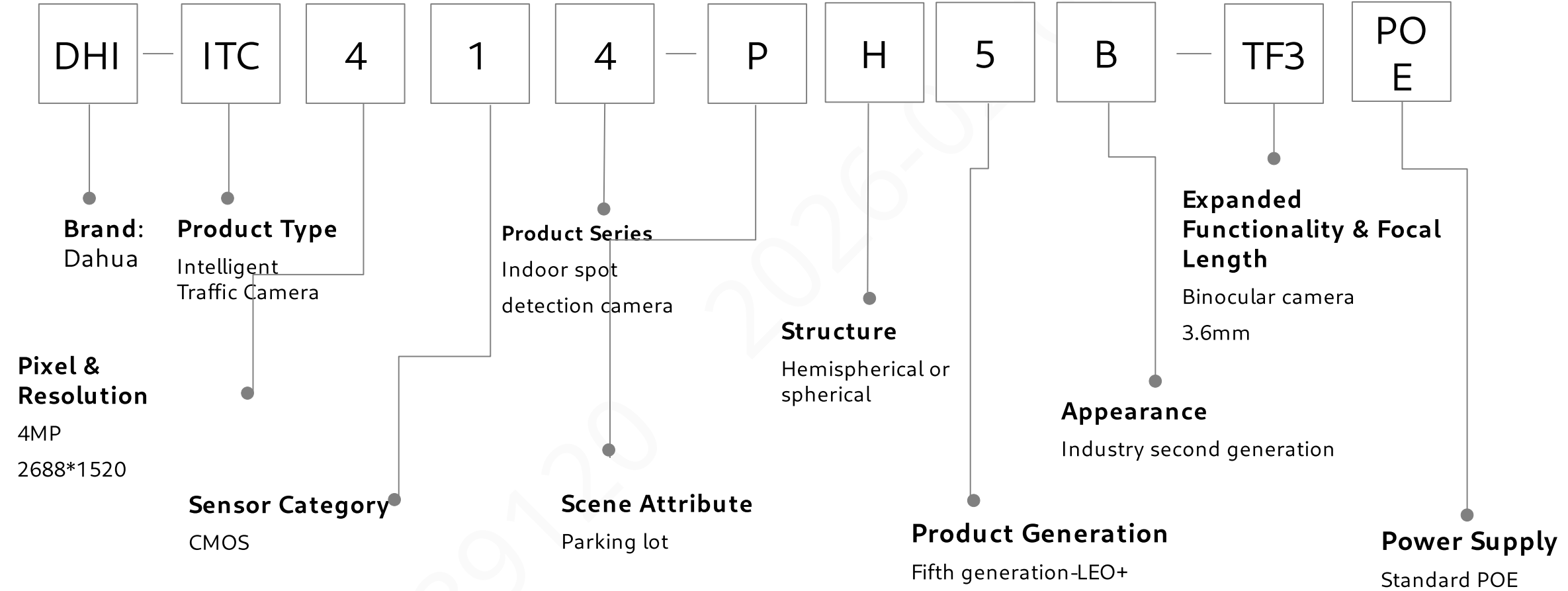

ITS-4MP Spot Detection Camera

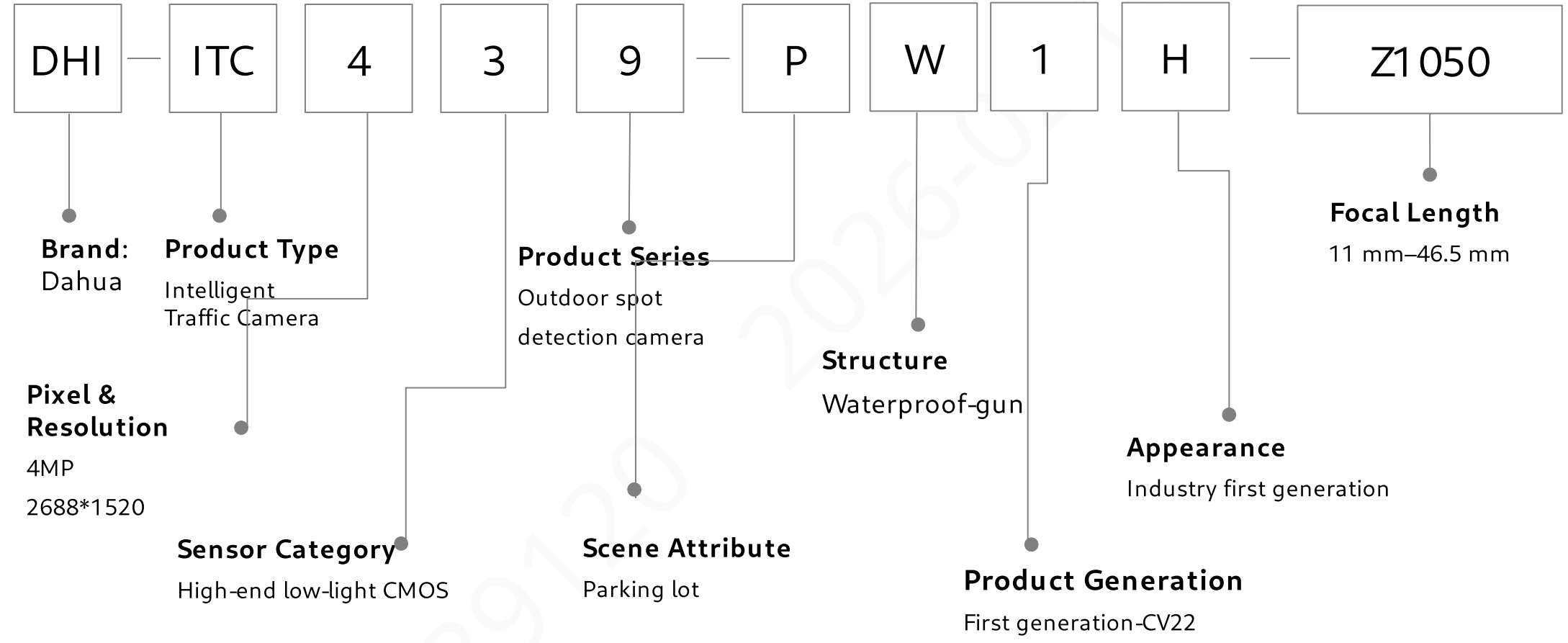

ITS-Access Barrier

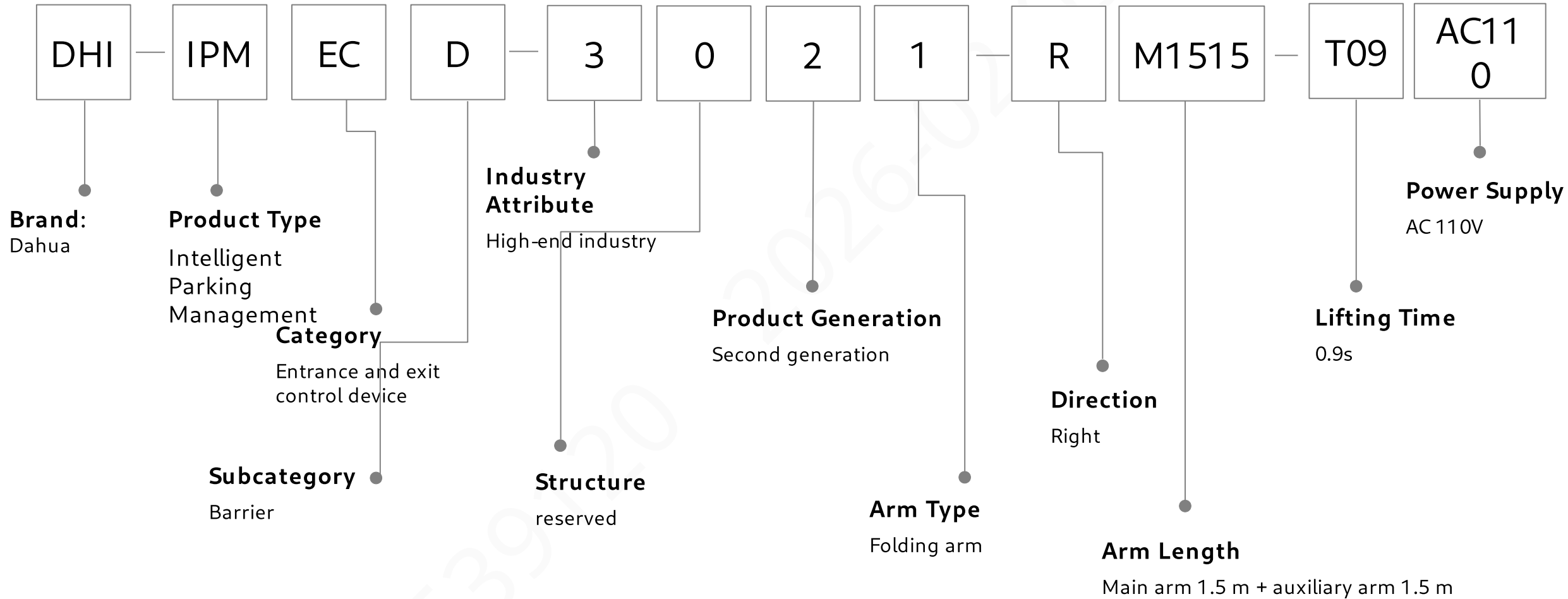

ITS-Folding Arm 1.5m-1.5m

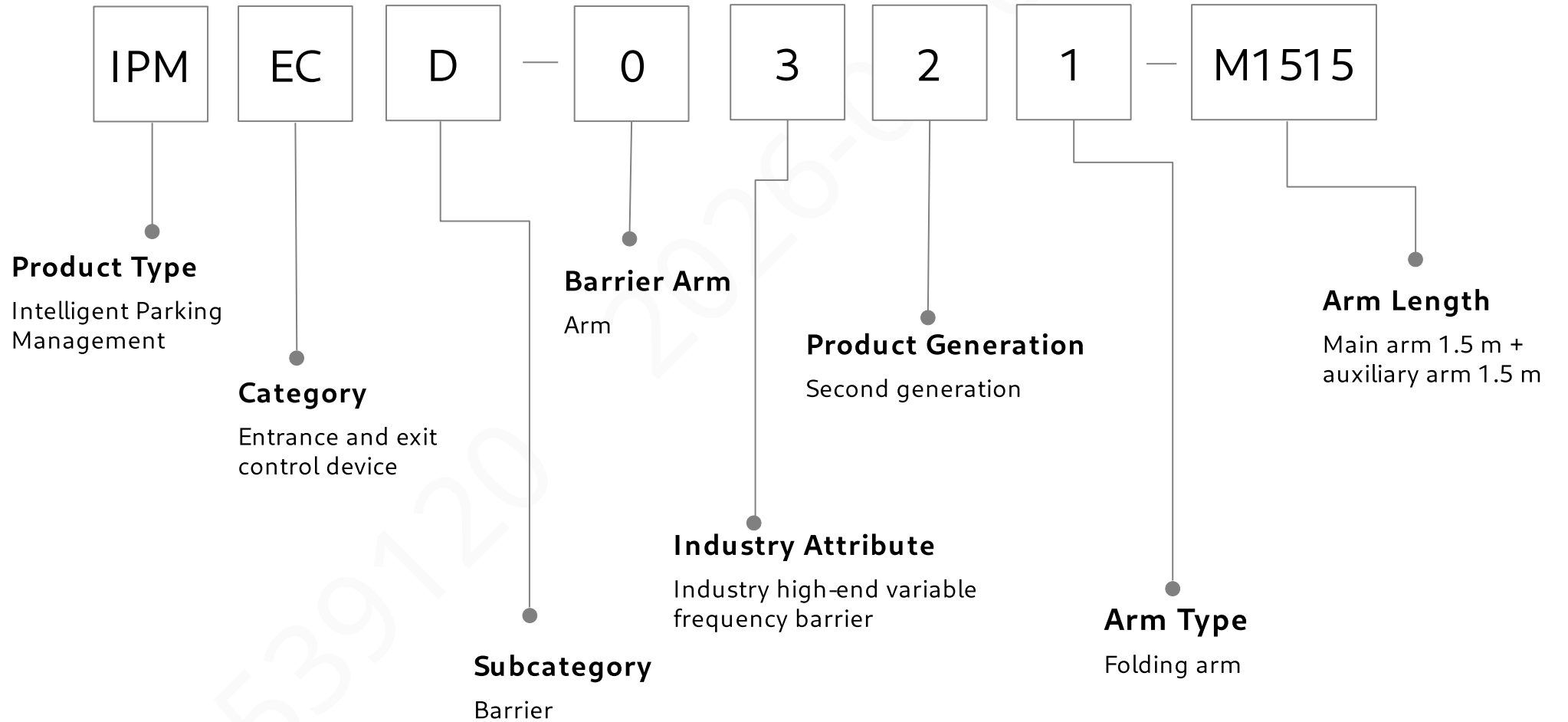

ITS-Indoor Guidance Screen (One-Layer)

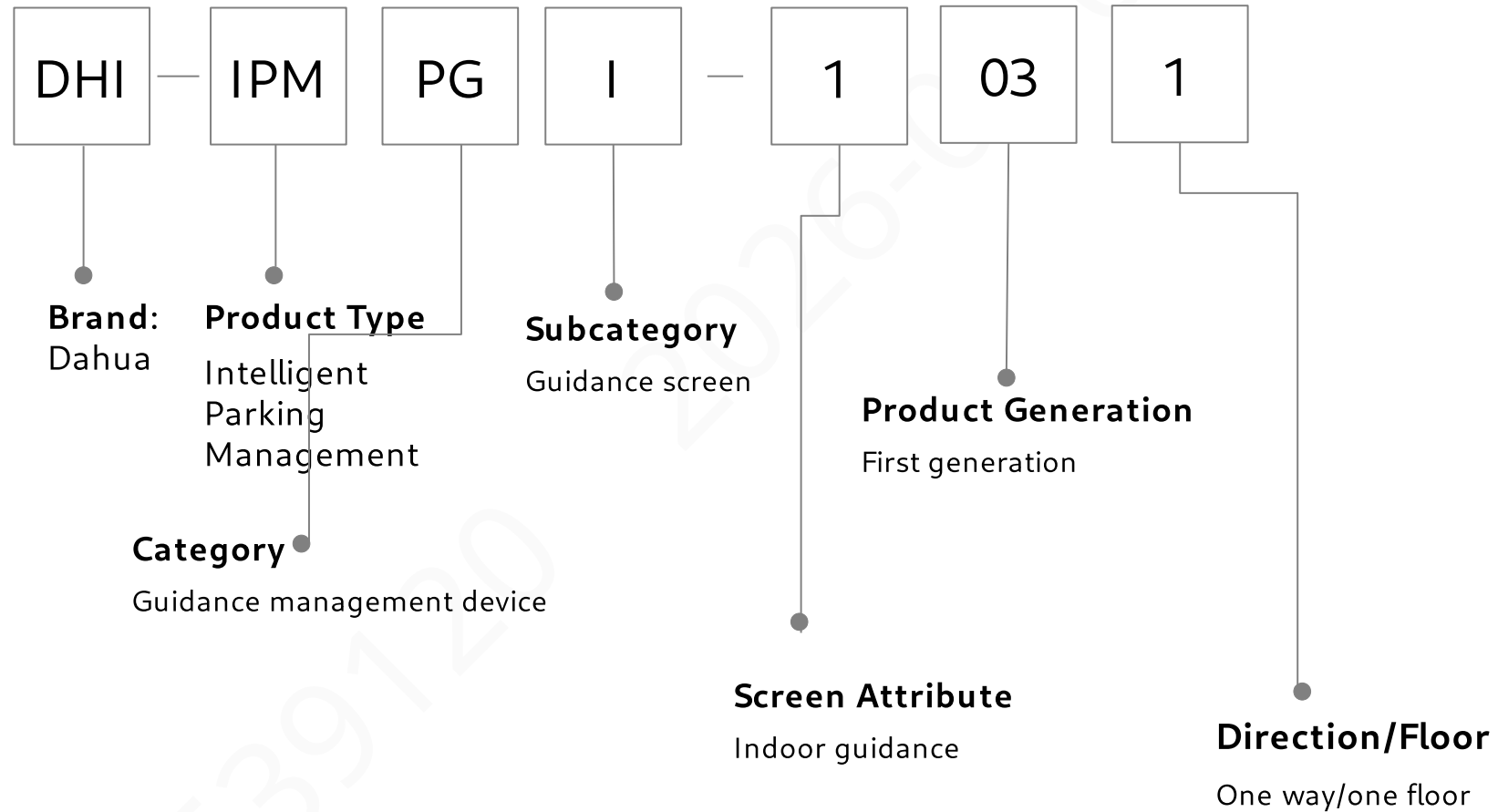

ICS-AC EV Charger

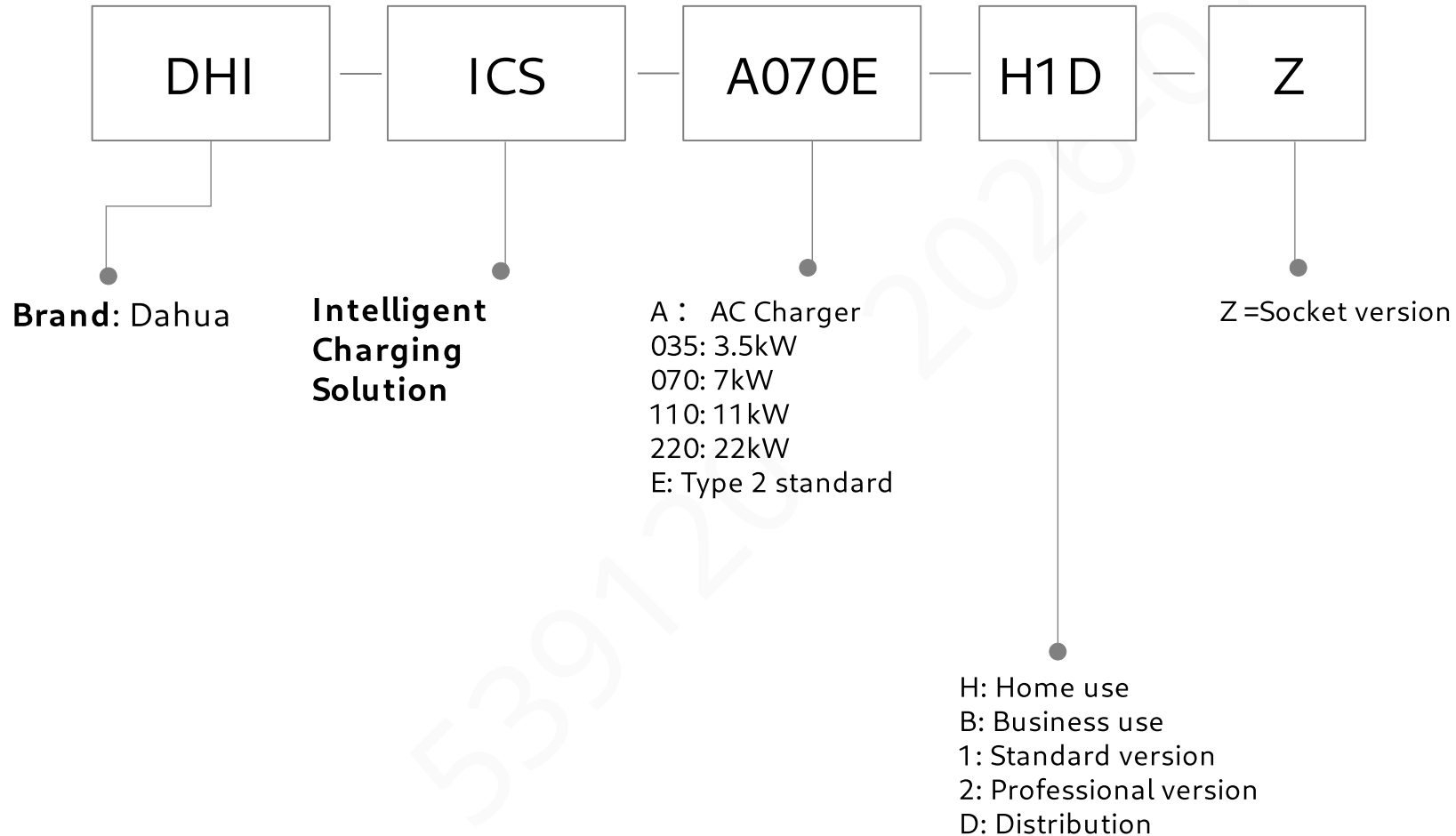

ICS-DC EV Charger

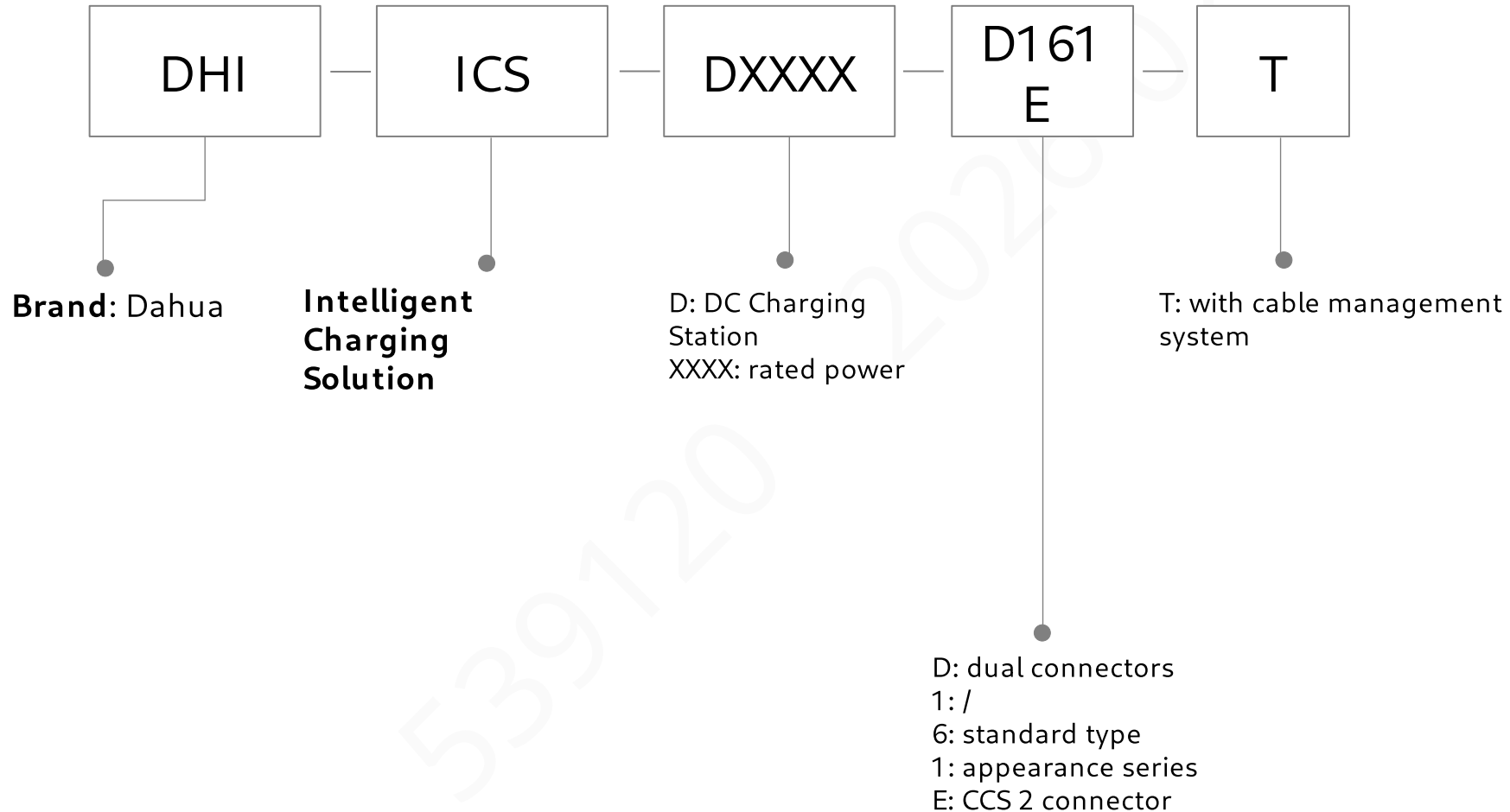

D-Volt Charging System

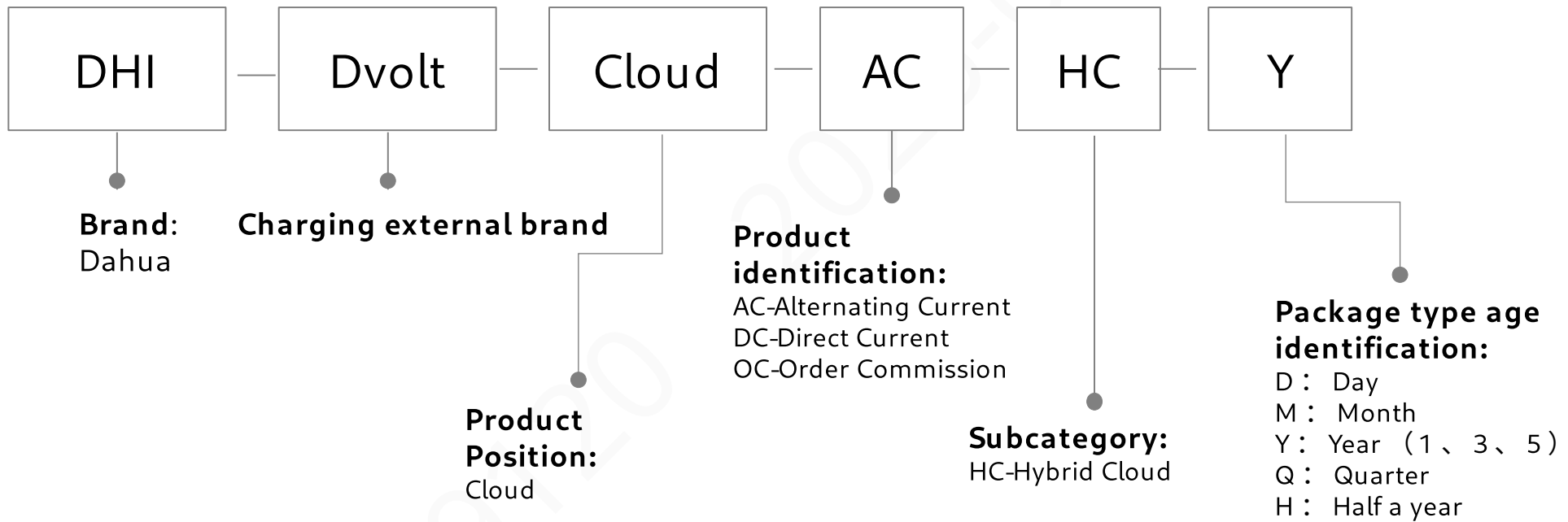

SSD

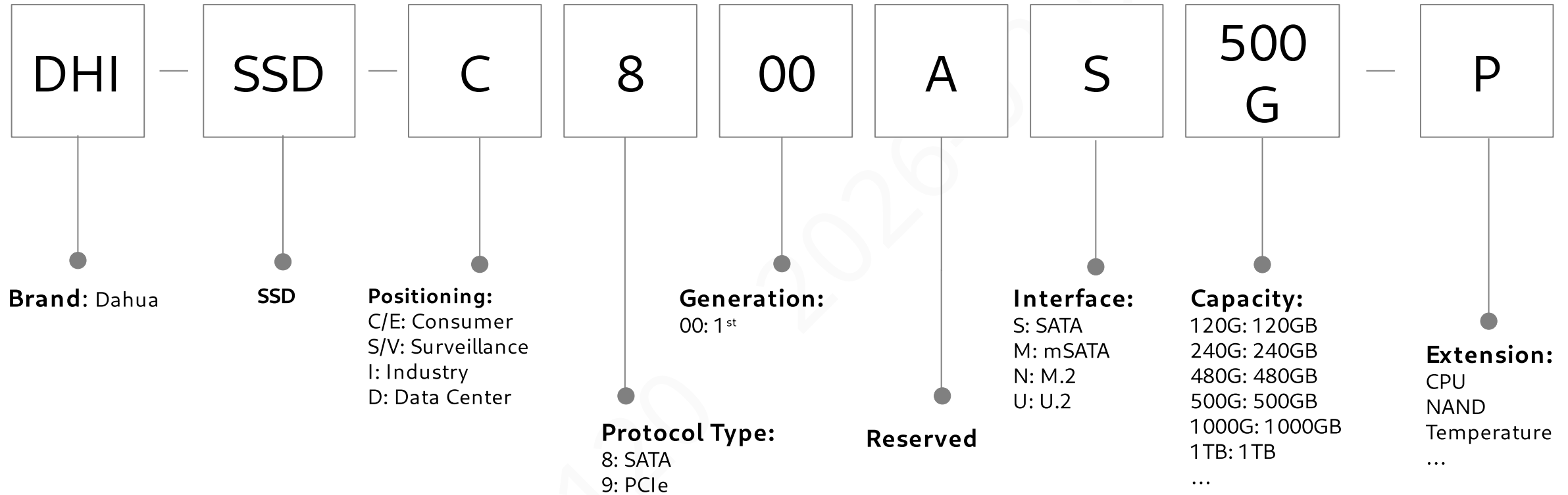

Thermal Camera

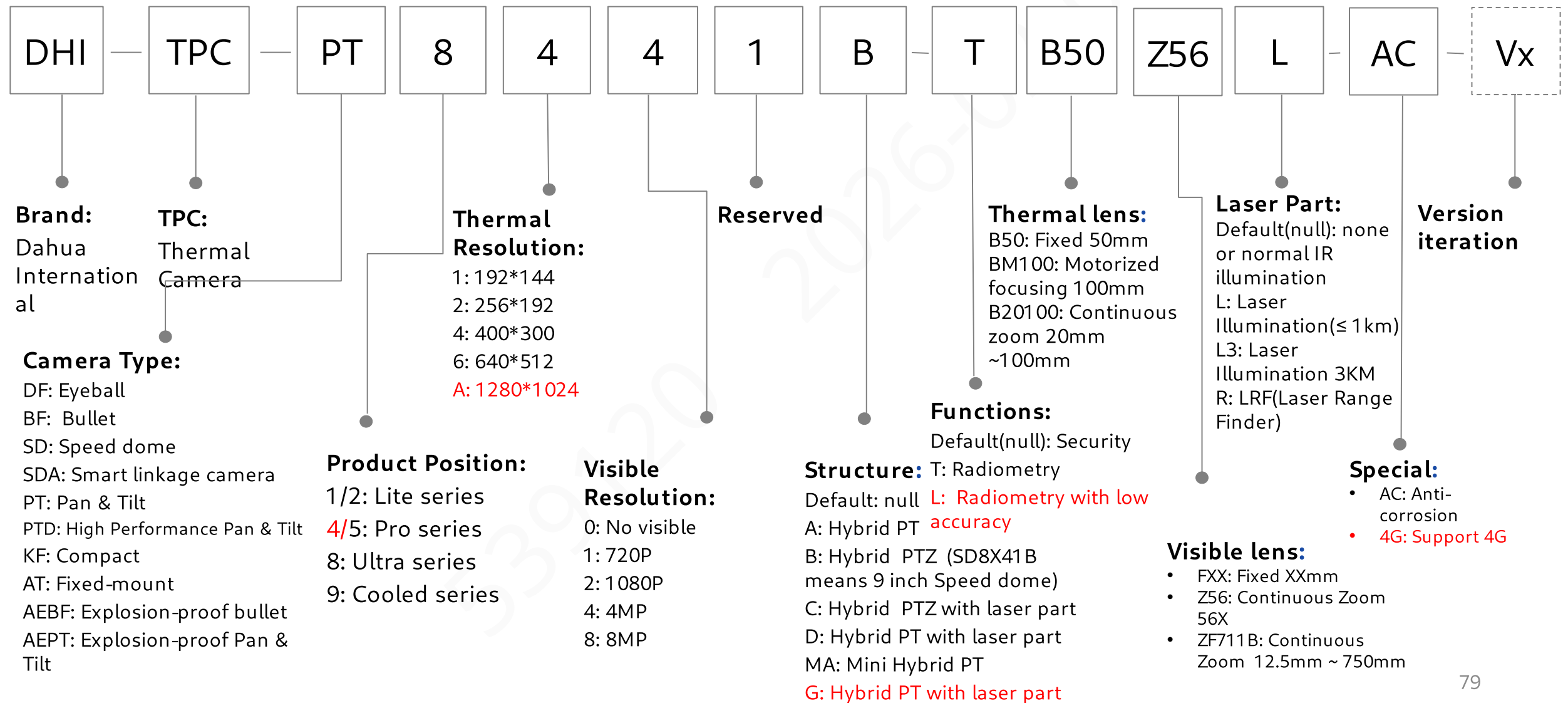

Thermal Module

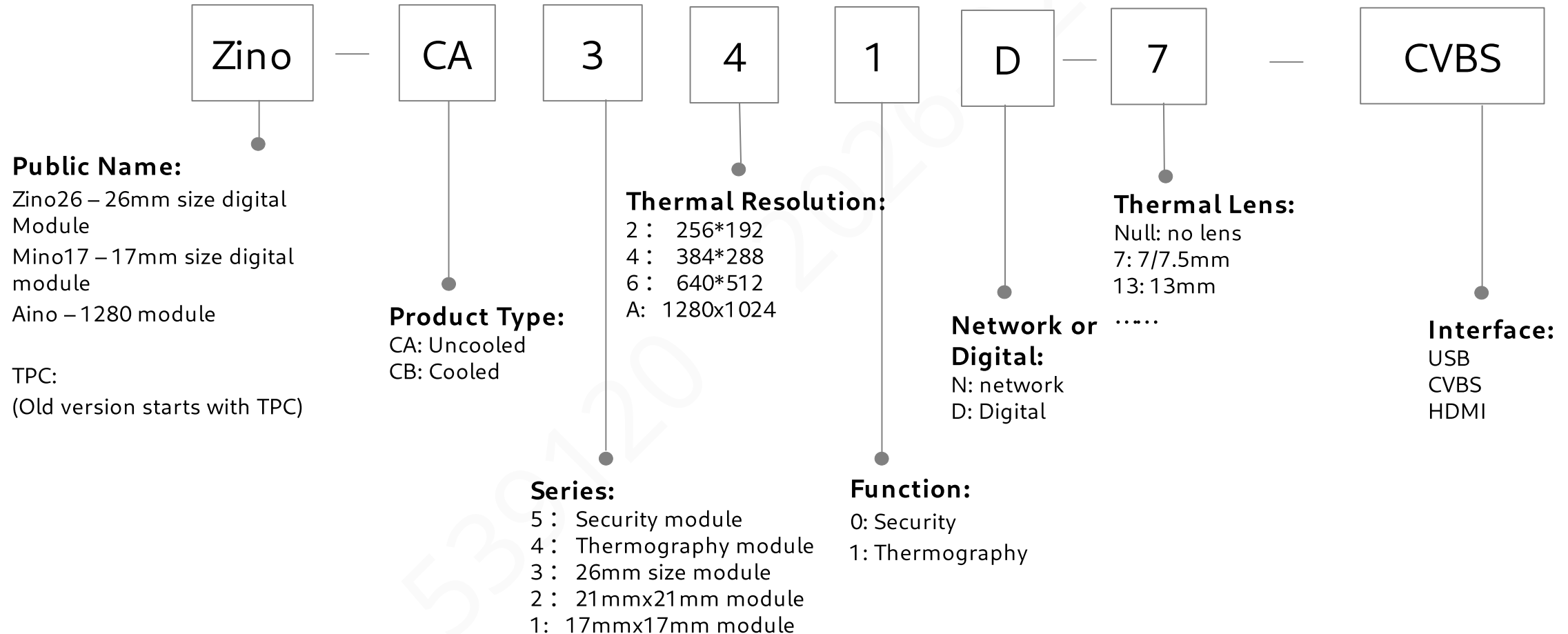

Thermal Camera-PVS

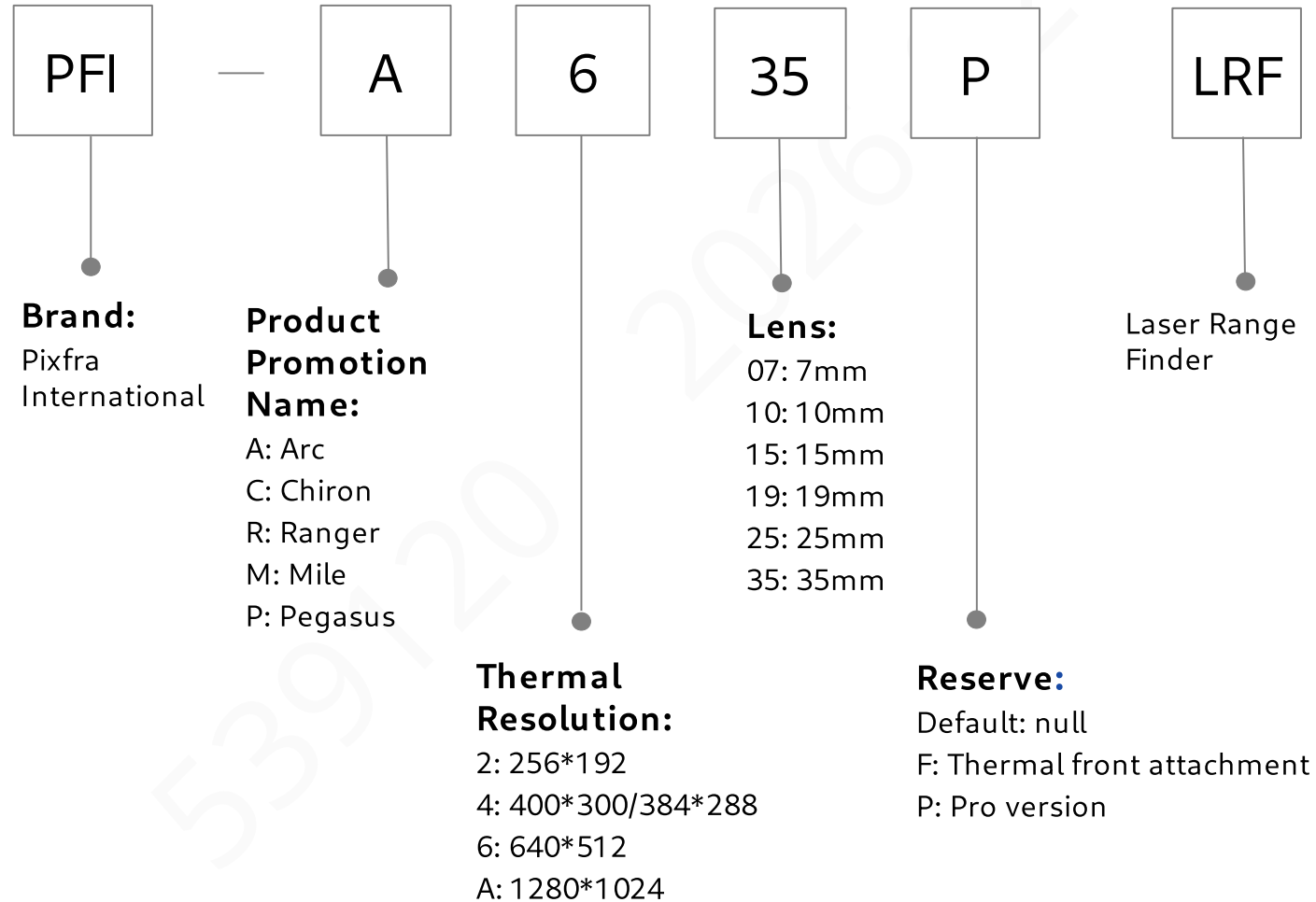

Handheld Thermography

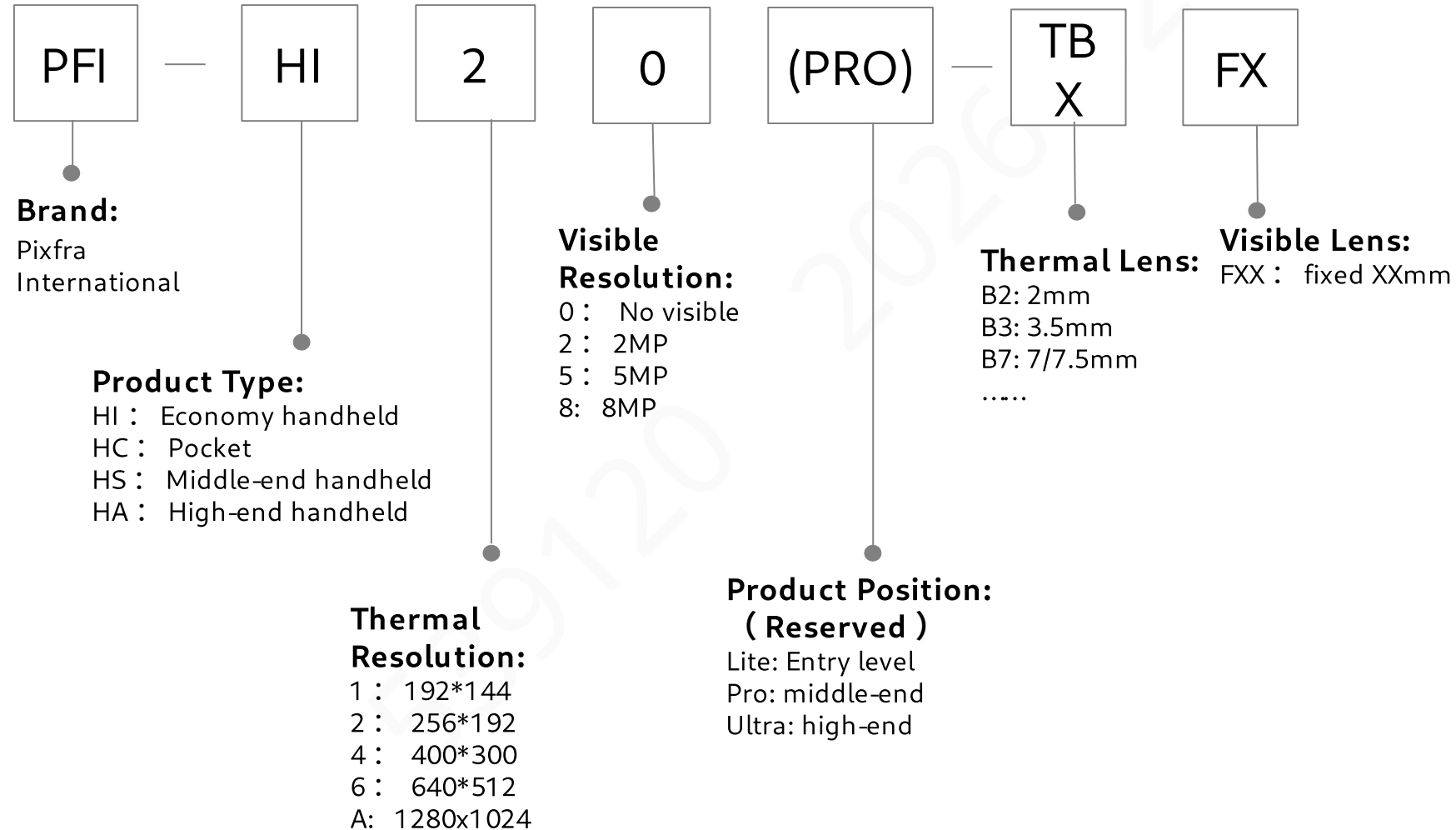

Monitor-CCTV

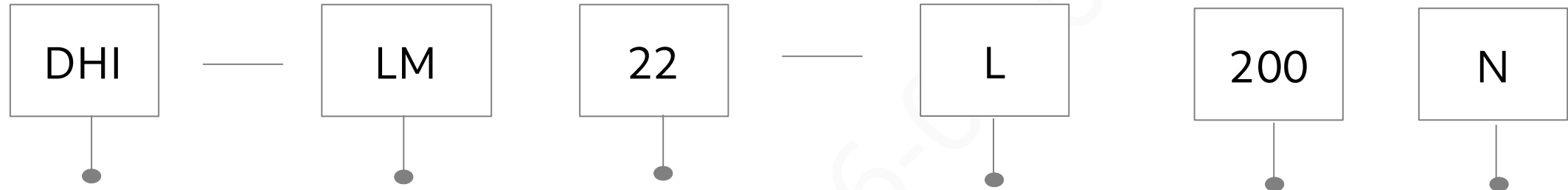

Brand:
Overseas Dahua

LED Monitor

Size:
19: 19"
22: 22"
.....
98: 98"

Positioning:
S: High-end level (metal case, high protection)
F: Standard level (plastic case)
H: Industry level (plastic case)
J: Energy-saving model (plastic case, long lifespan)
L: Entry level (plastic case, cost-effective)

Resolution :
100 < 1080P
200=1080P
400=4K

Reserved

监视器规格型号命名规则											
		必填		必填	必填		必填	必填	必填	必填	选填
	字段号	①		②	③		④	⑤	⑥	⑦	⑧
液晶监视器产品 (监视器)	标识	公司标识		产品线标识	尺寸标识		产品定位	分辨率	预留1	预留2	功能外观
	实例	DH	-	LM	22	-	S	2	0	0	缺省/A-Z
	说明	DH=大华品牌 DHI=海外大华品牌 缺省=海外中性		LM=液晶监视器	19=尺寸信息19寸 22=尺寸信息22寸 24=尺寸信息24寸 98=尺寸信息98寸		S=高端款 (金属壳, 多接口) F=主推款 (塑壳, 多接口) H=流量款 (塑壳, 带Speaker) J=节能款 (低功耗长寿命) L=入门款 (塑壳, H+V) V=项目预留	1 < 1080P 2=FHD 3=QHD 4=UHD 5=5K	位号预留, 默认0	位号预留, 默认0	C: 曲面屏 N, Y: 预留, 用于市场差异化宣传
典型范例	DHI-LM22-J200										

Monitor-IT

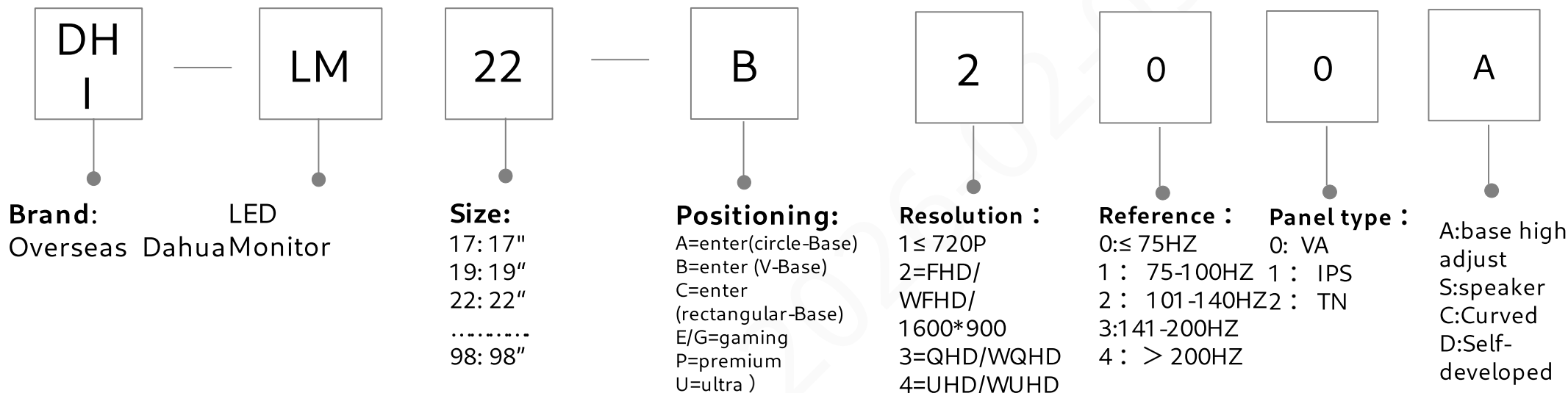

IT显示器外部型号命名规则

	必填	必填	必填	必填	必填	必填	必填	必填	必填	必填
字段号	①	②	③	④	⑤	⑥	⑦	⑧	⑨	⑩
标识	公司标识	产品线标识	尺寸标识	系列	分辨率	刷新率	面板类型	功能外观定义		
实例	DHI	-	LM	-	A	2	0	0	缺省/A-Z	
说明	DH=大华品牌 DHI=海外大华品牌 缺省=海外中性 N=国内中性	LM=显示器	17=尺寸信息17寸 19=尺寸信息19寸 22=尺寸信息22寸 98=尺寸信息98寸	A=入门显示器 (圆形底座, 仅流量机型以底座区分) B=入门显示器 (V型底座) C=入门显示器 (方型底座) E/G=电竞专用 (gaming) P=中端系列 (premium) U=高端系列 (ultra)	1≤720P 2=FHD/WFHD/1600*900 3=QHD/WQHD 4=UHD/WUHD	0:≤75HZ 1: 75-100HZ 2: 101-140HZ 3:141-200HZ 4: > 200HZ	0: VA 1: IPS 2: TN	主推款默认缺省; 同类产品可用一位字母表示子系列; A-带升降支架 S-带speaker C-曲面 D-自研		

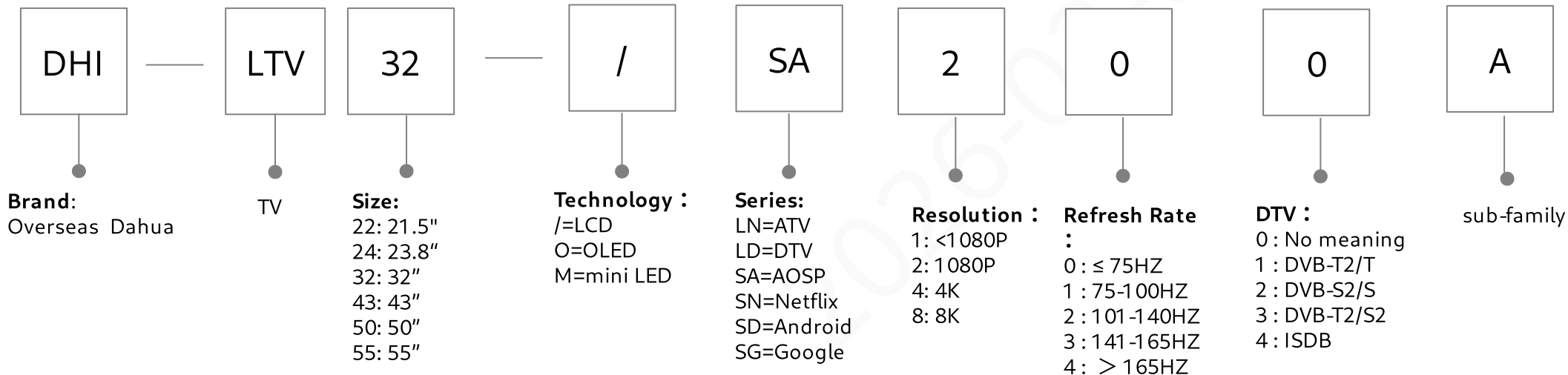

电视机外部型号命名规则

	必填		必填	必填		选填	必填	选填 (D/G必填)	必填	必填	必填	选填
字段号	①		②	③		④	⑤	⑥	⑦	⑧	⑨	⑩
标识	公司标识		产品线标识	尺寸标识		技术	性能	系列名称	分辨率	刷新率	制式	缺省
实例	DHI	-	LTV	32	-	/	SA	/	2	0	0	
说明	DH=大华品牌 DHI=海外大华品牌 FSI=丰视海外 H=国内中性 缺省=海外中性		LTV=电视机	17=尺寸信息17寸 19=尺寸信息19寸 22=尺寸信息22寸 98=尺寸信息98寸		/=LCD O=OLED M=mini LED	LN=模拟ATV LD=数字DTV SA=智能 (AOSP) SN=智能 (Linux+Netflix) SD=智能 (Android) SG=智能 (Google)		1≤720P 2=FHD/WFHD/1600*900 3=QHD/WQHD 4=UHD/WUHD	0:≤75HZ 1: 75-100HZ 2: 101-140HZ 3:141-165HZ 4: > 165HZ	0-无含义 1-DVB-T2/T 2-DVB-S2/S 3-DVB-T2/S2 4-ISDB	

DHI-LTV32- SA200

LCD Video Wall

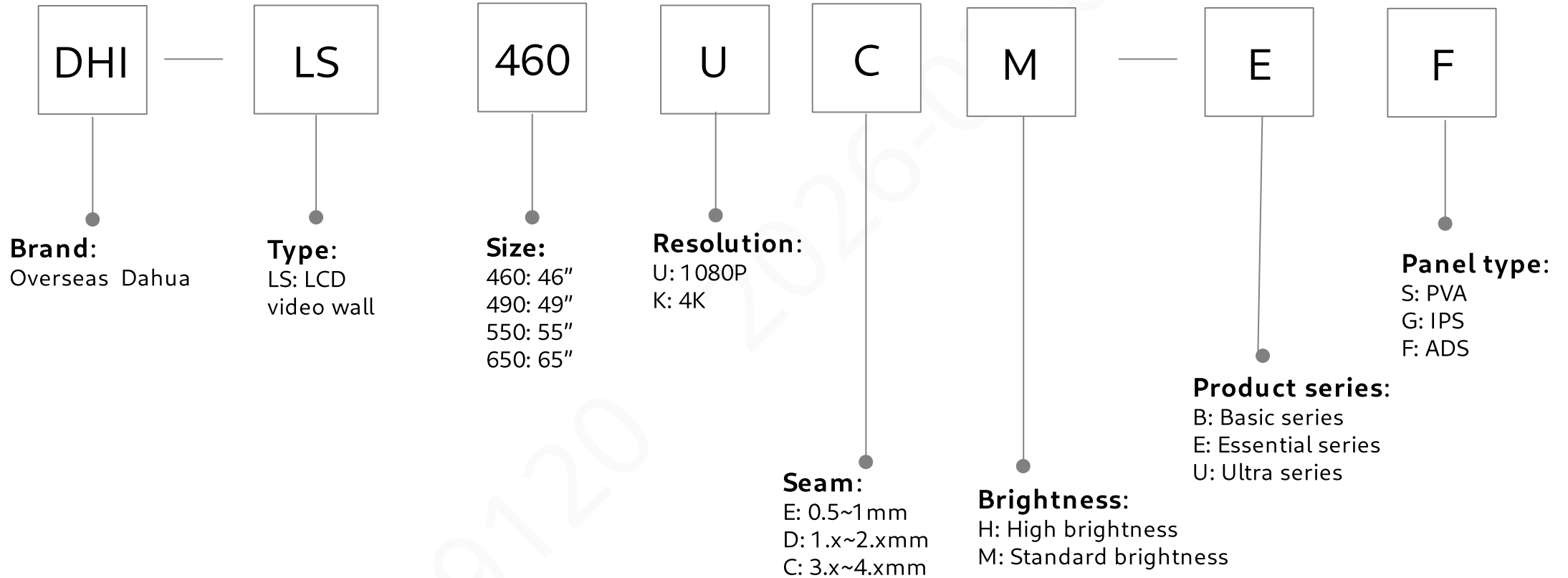

Digital Signage

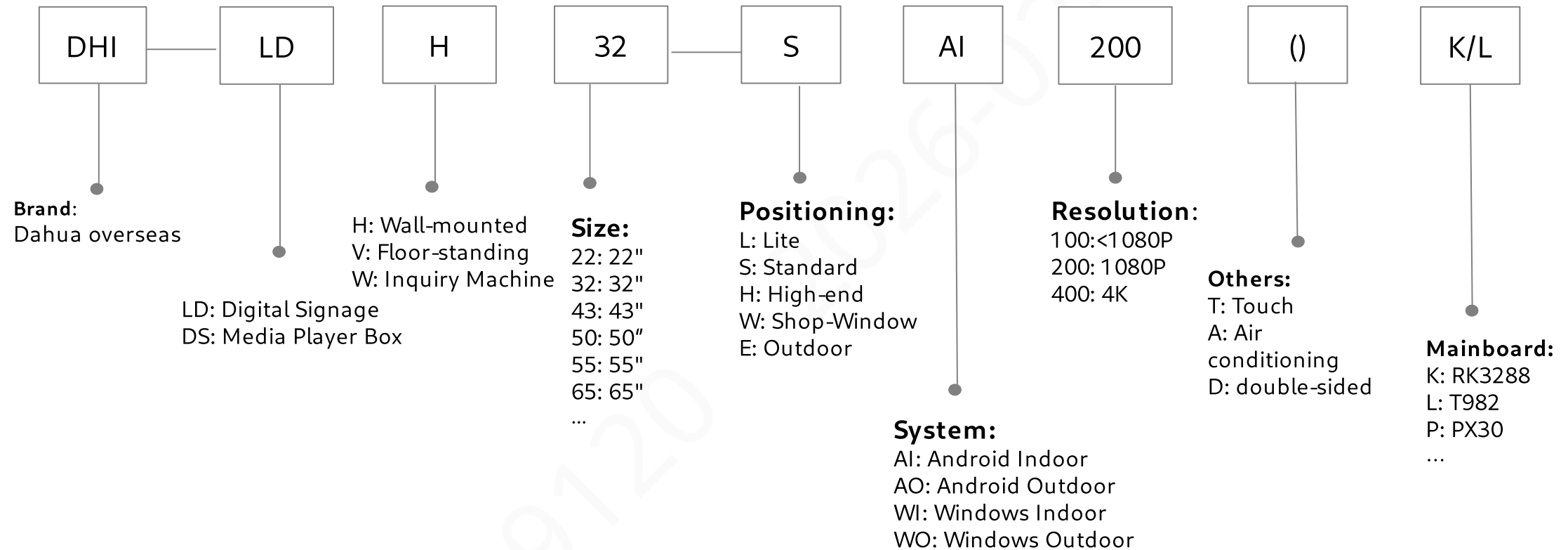

LED Display

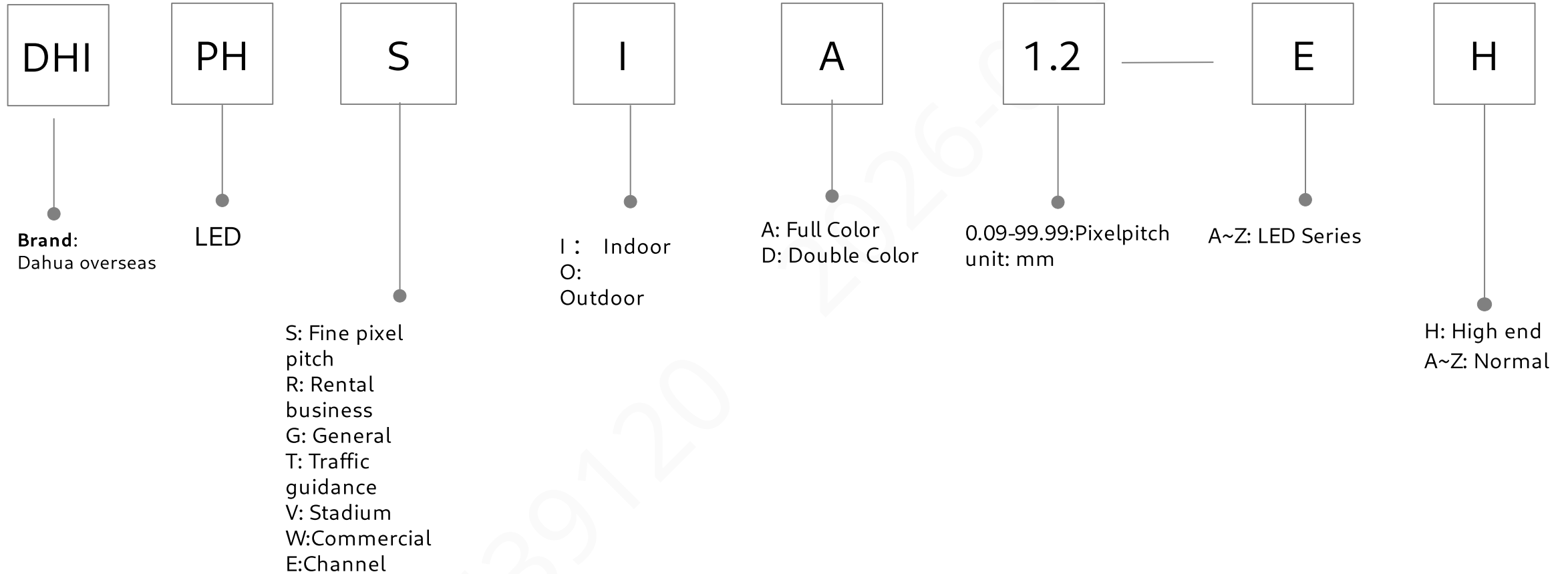

Decoder

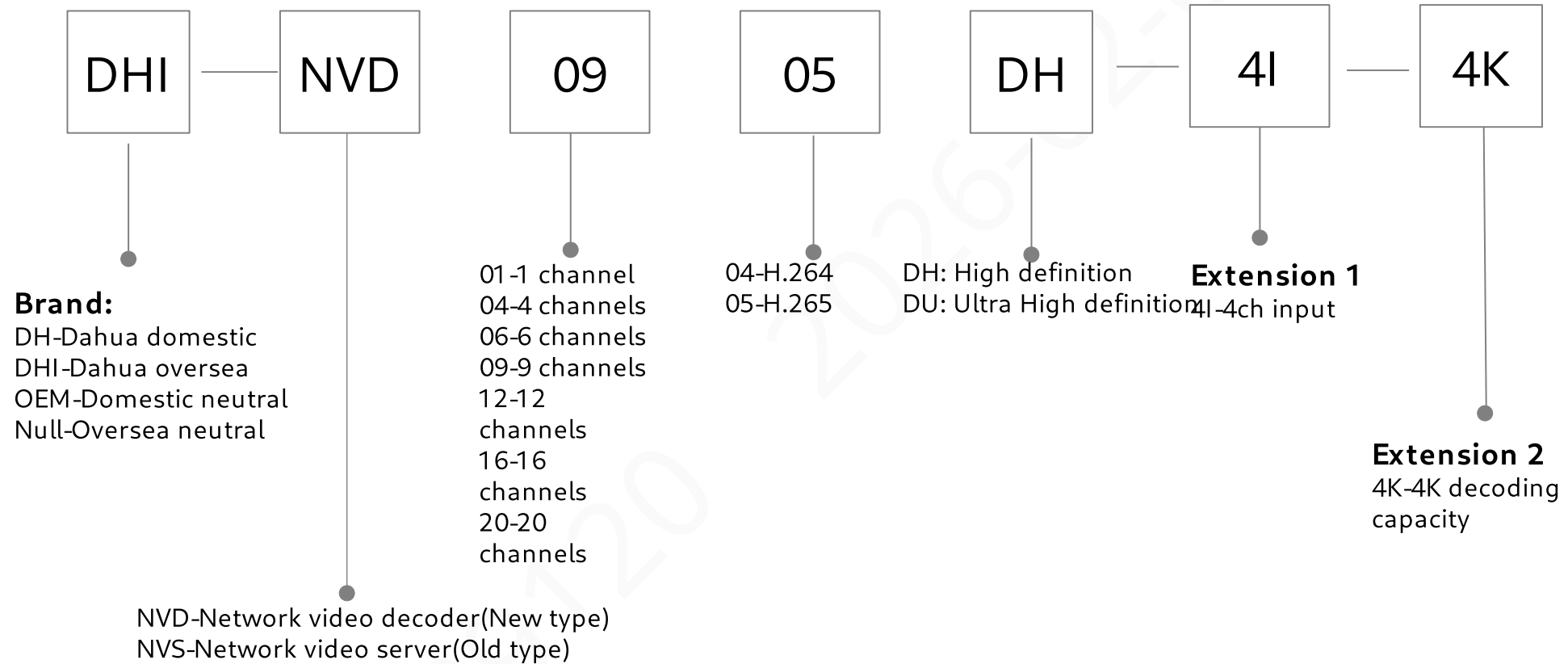

Matrix--Mainframe box

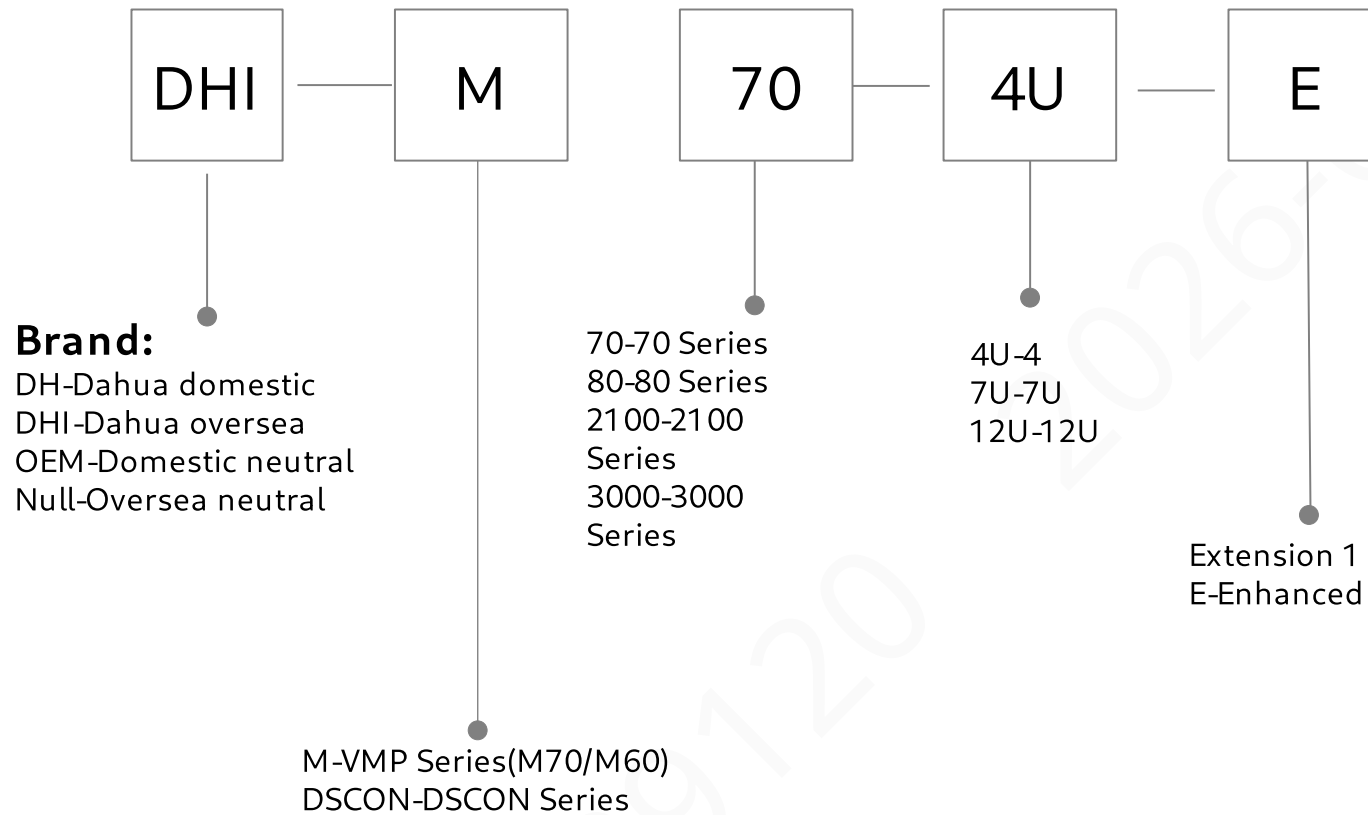

Matrix-Input/Output Card

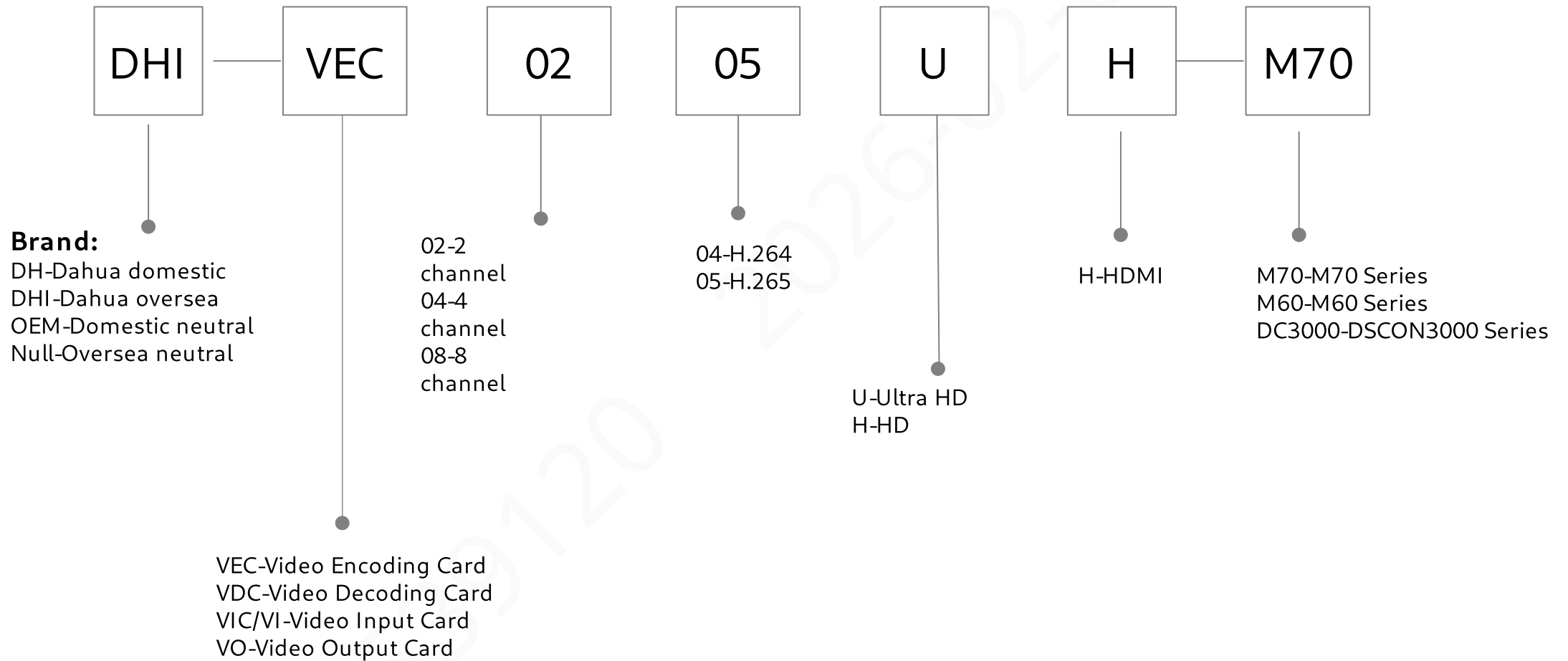

AVoIP

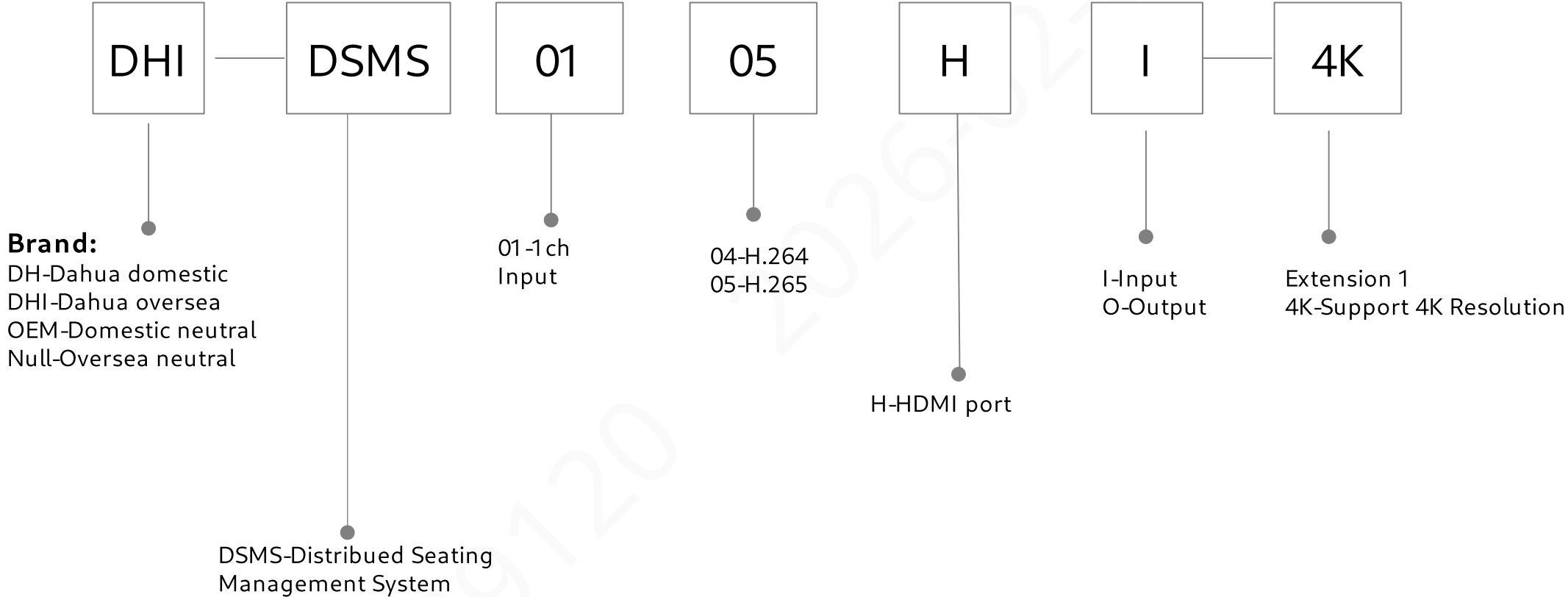

AVoIP

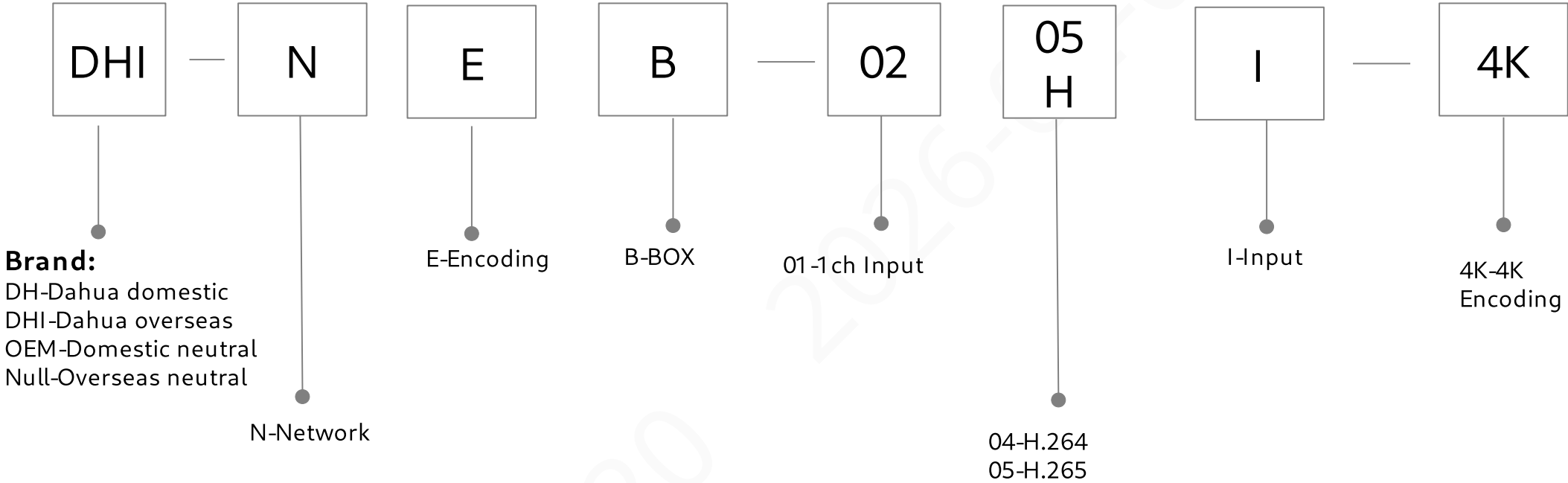

Speaker

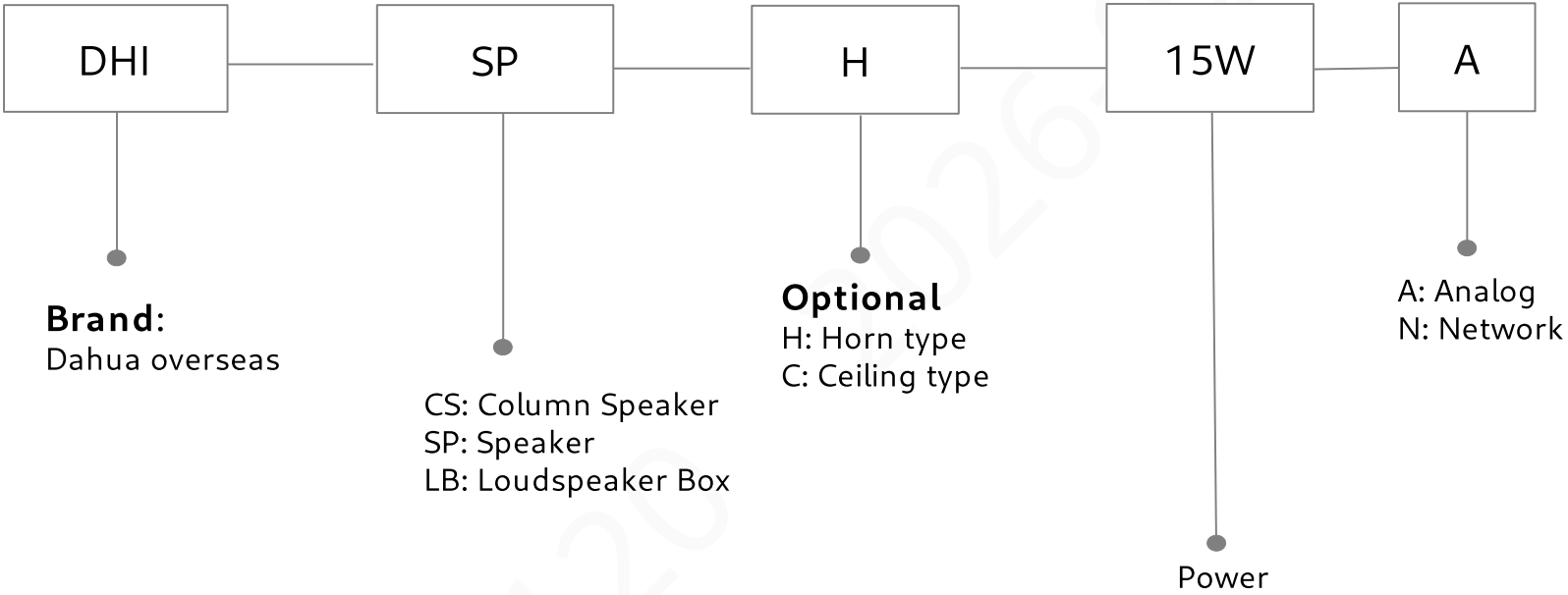

Pickup

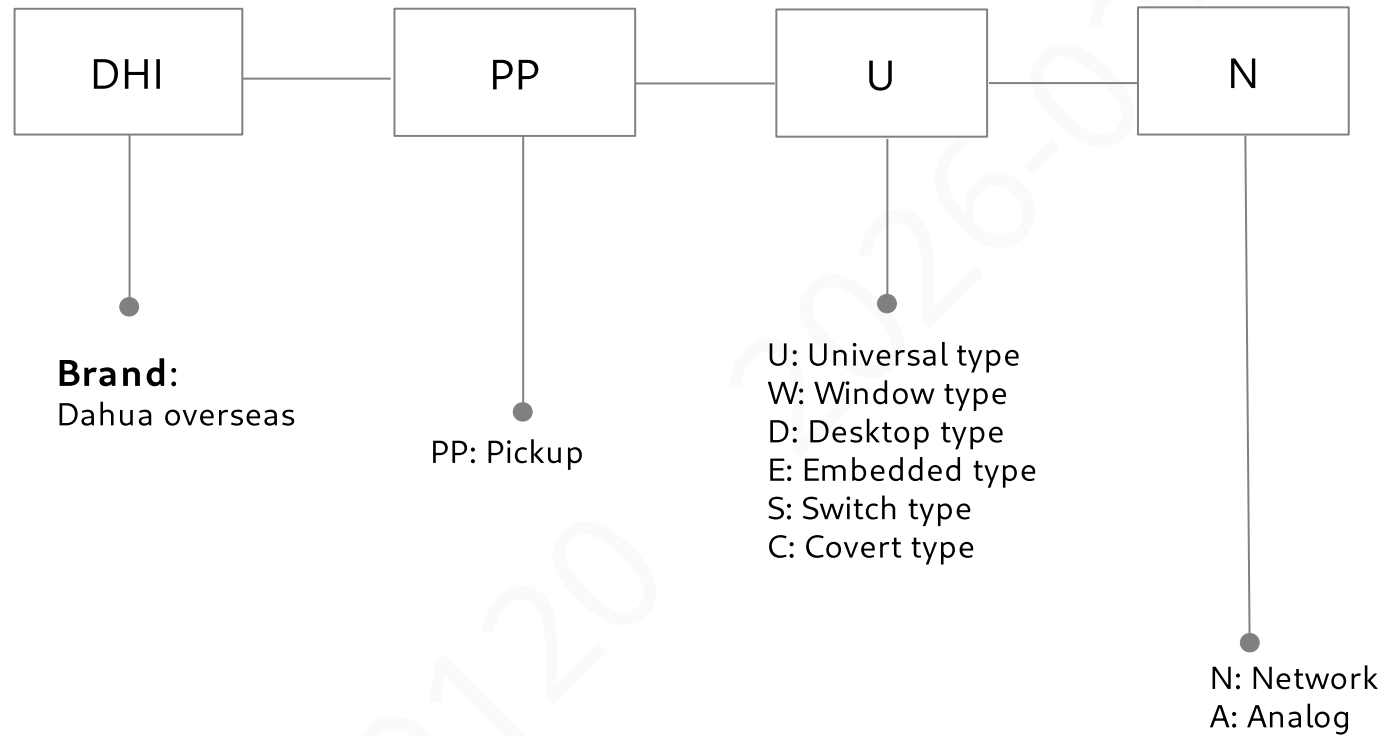

Power Amplifier

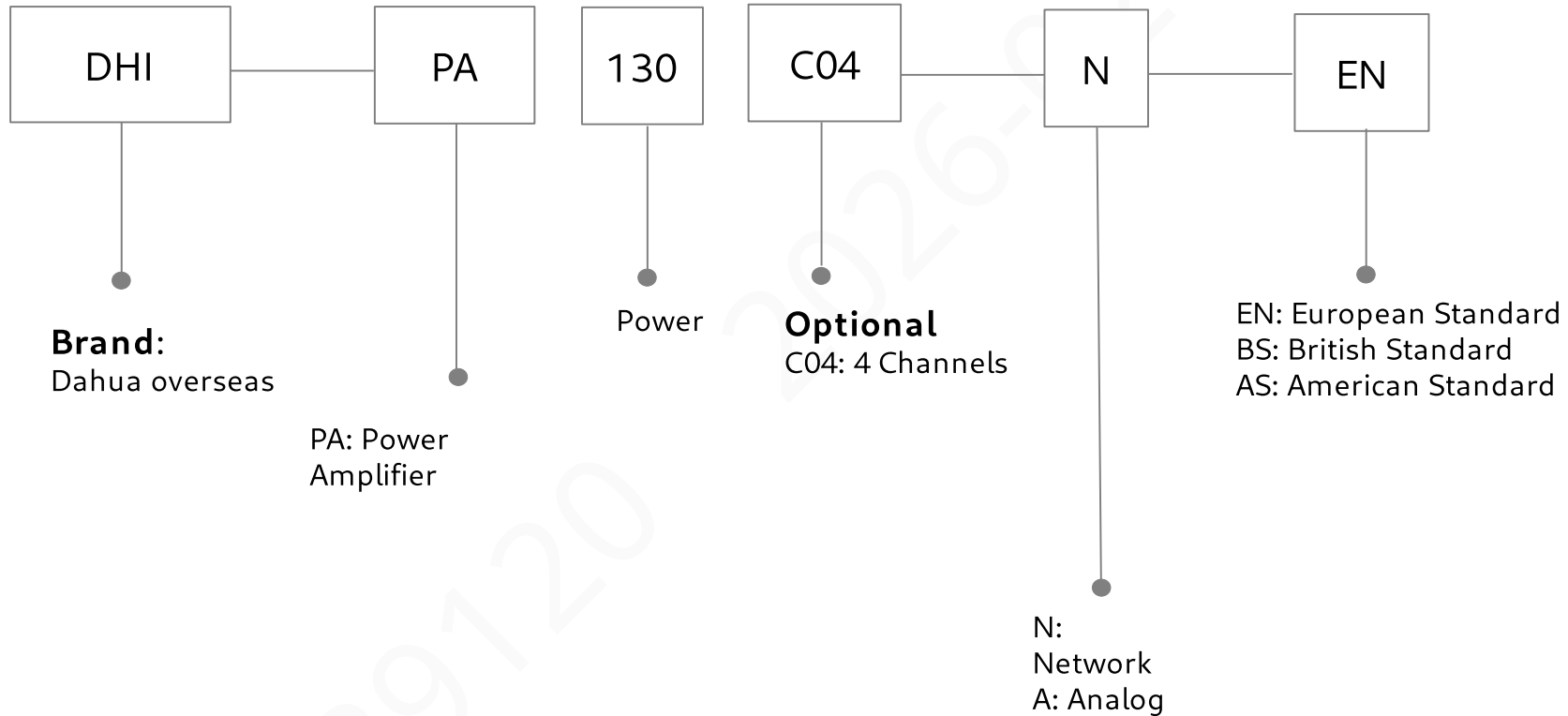

Microphone

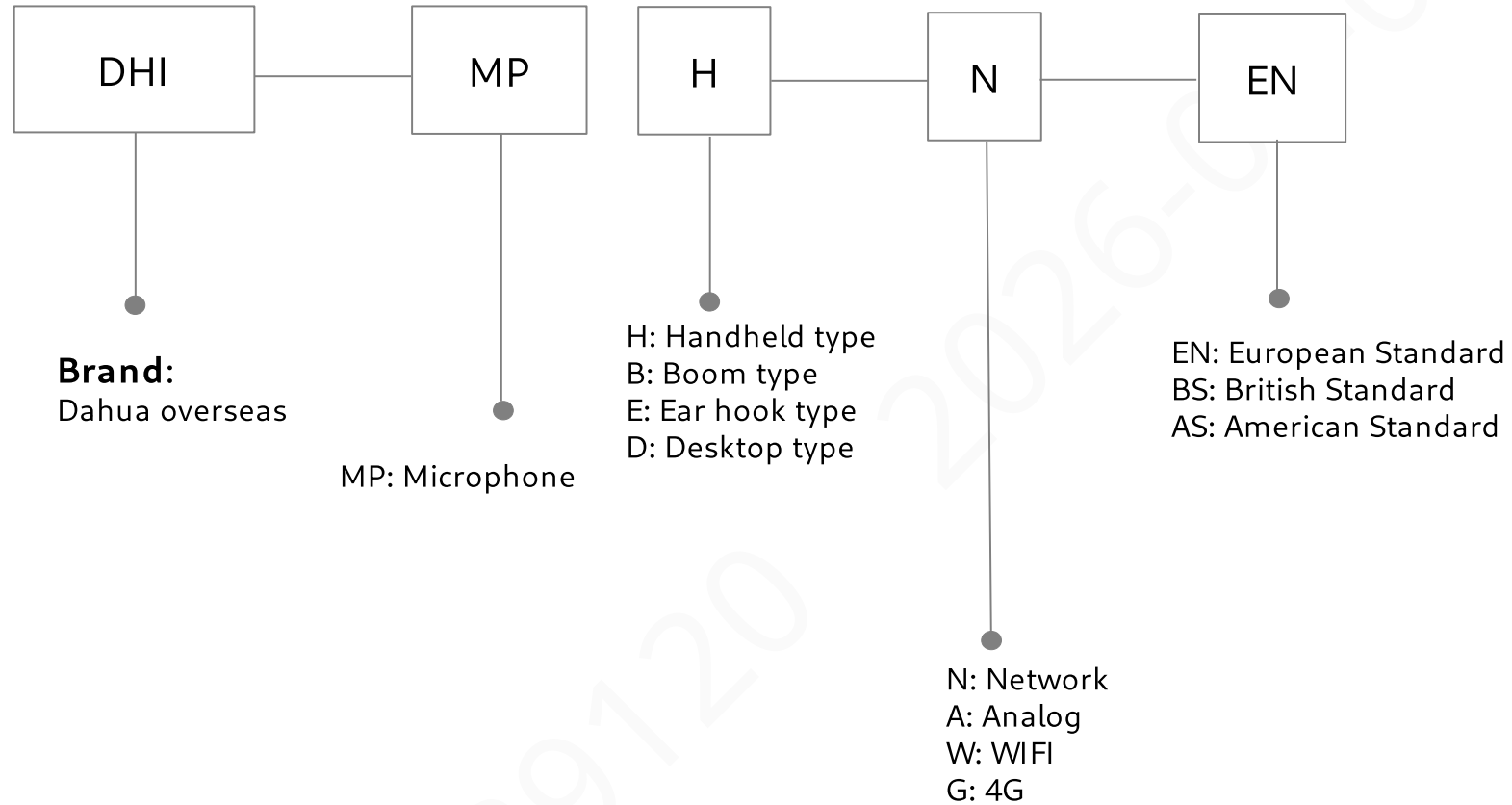

Metal Detector

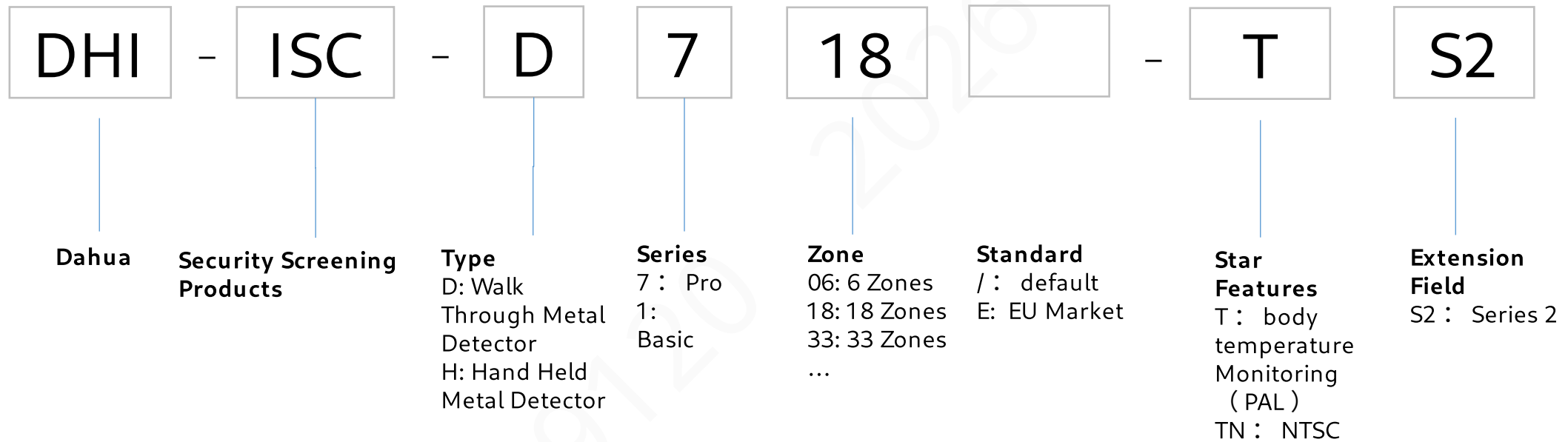

Baggage & Parcel Screening

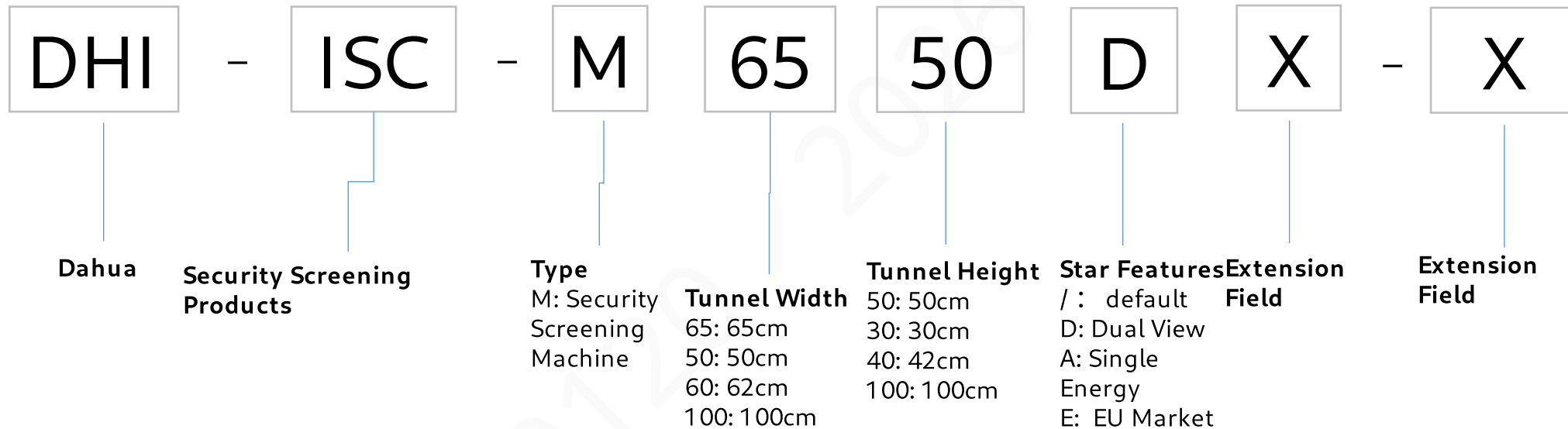

EAS Labels & Tags

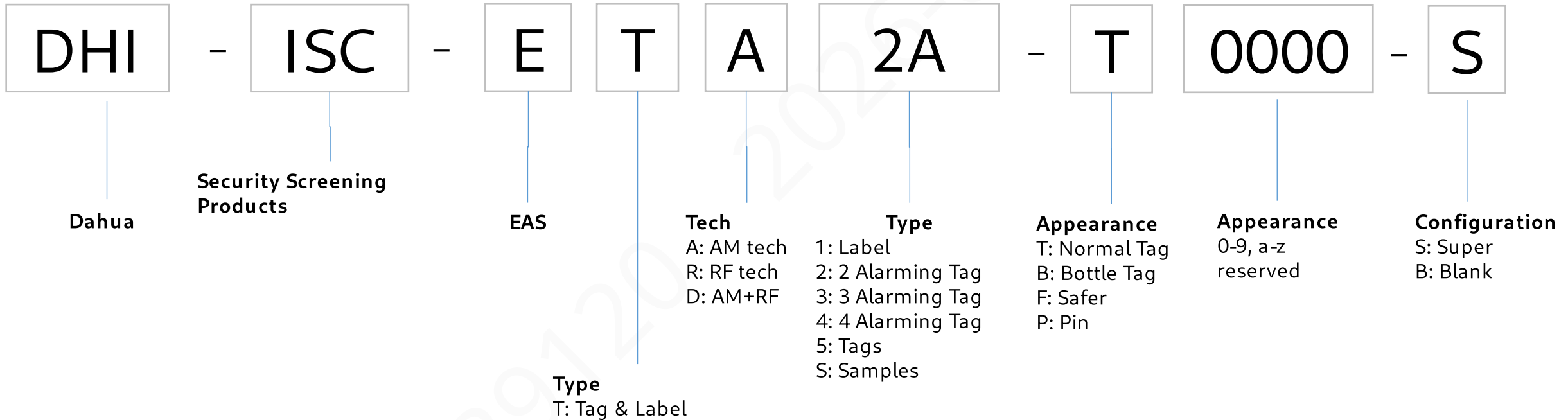

EAS antenna

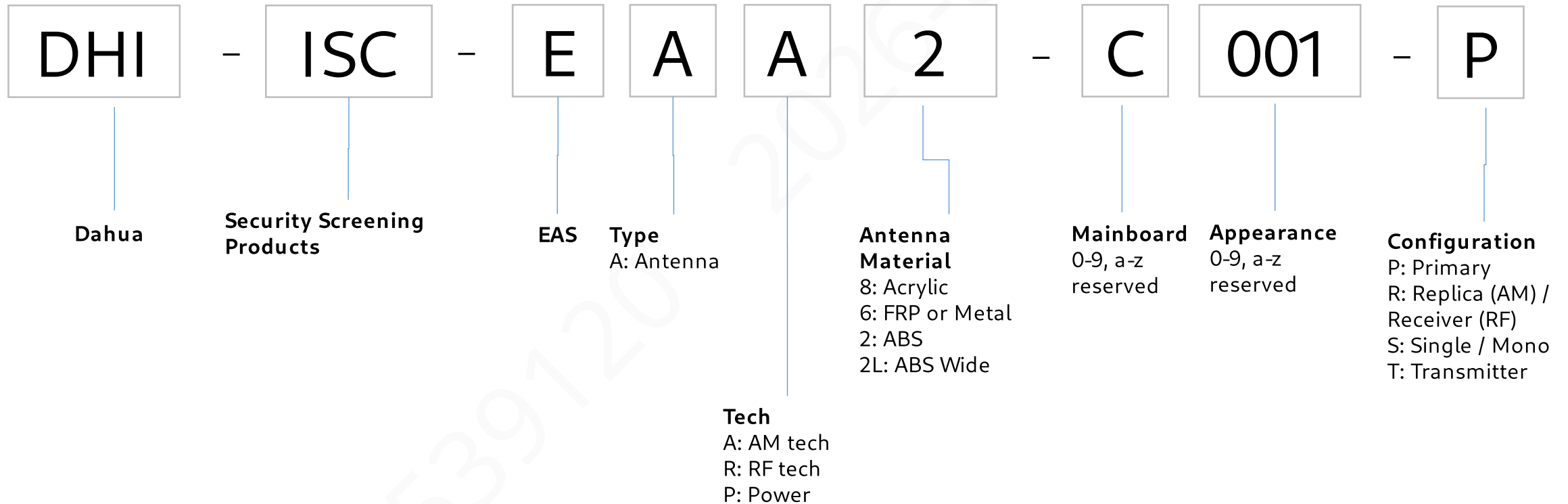

Mobile IPC

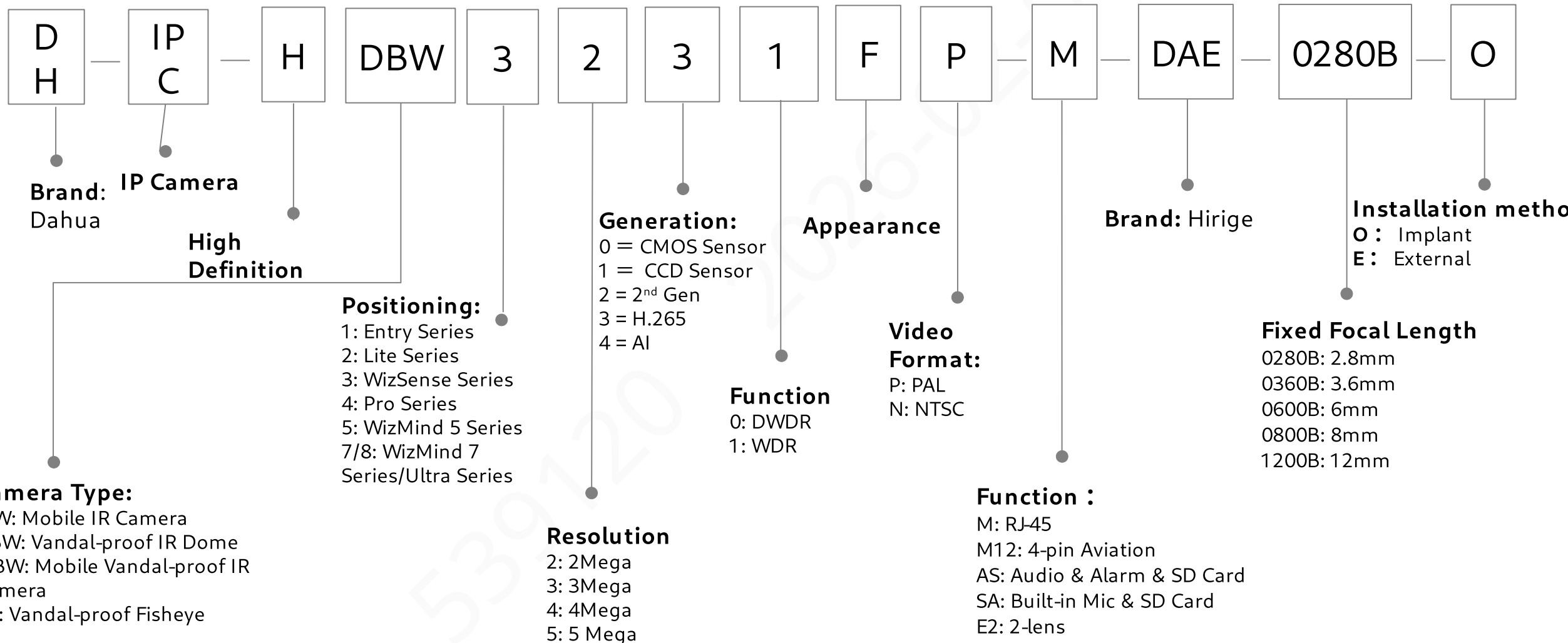

Mobile HDCVI Camera

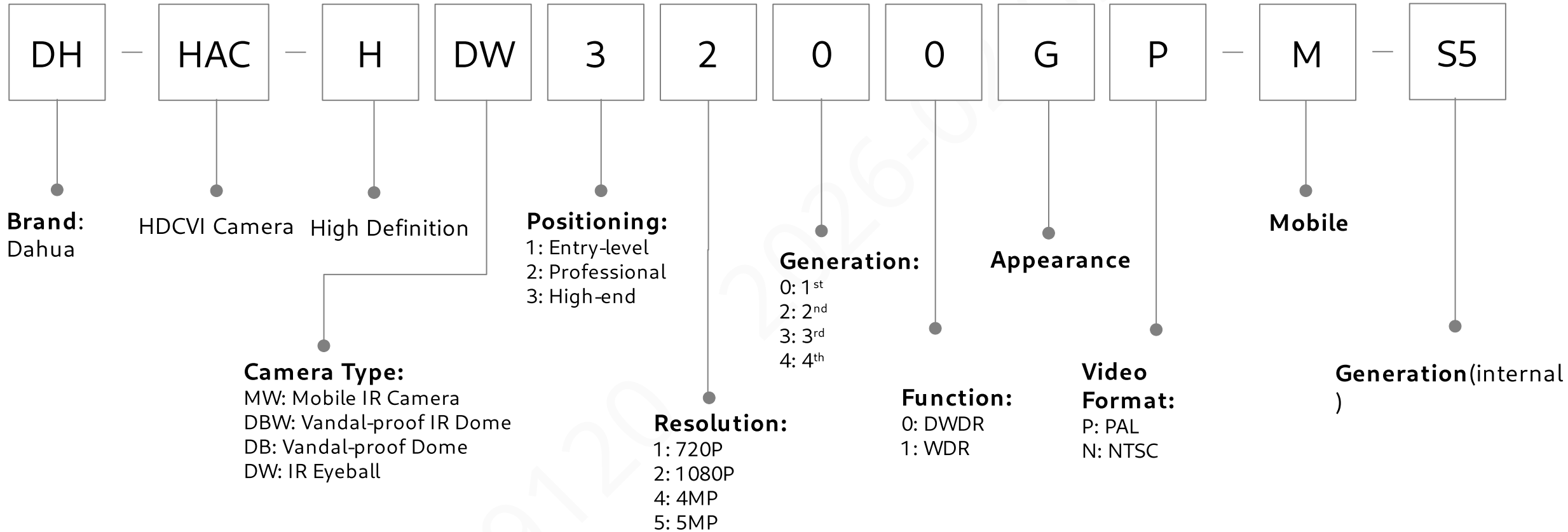

Dash Camera

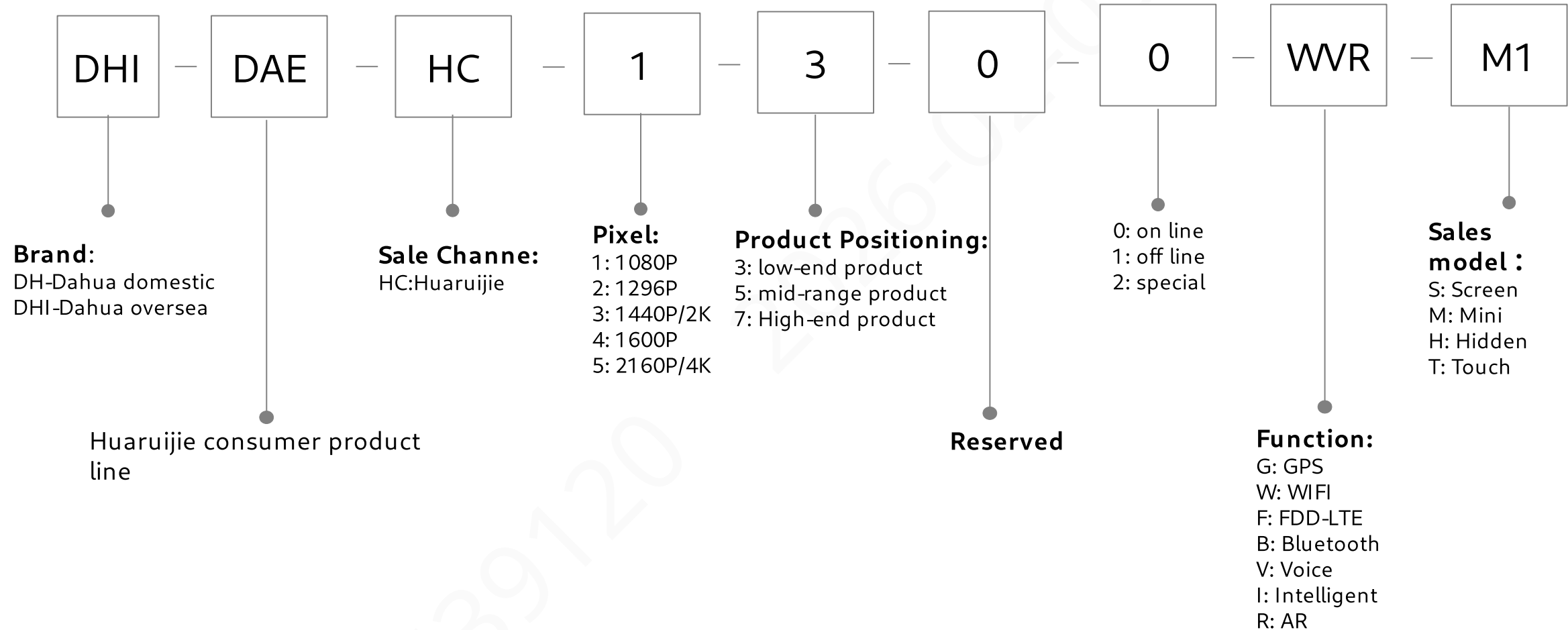

Mobile DVR/NVR

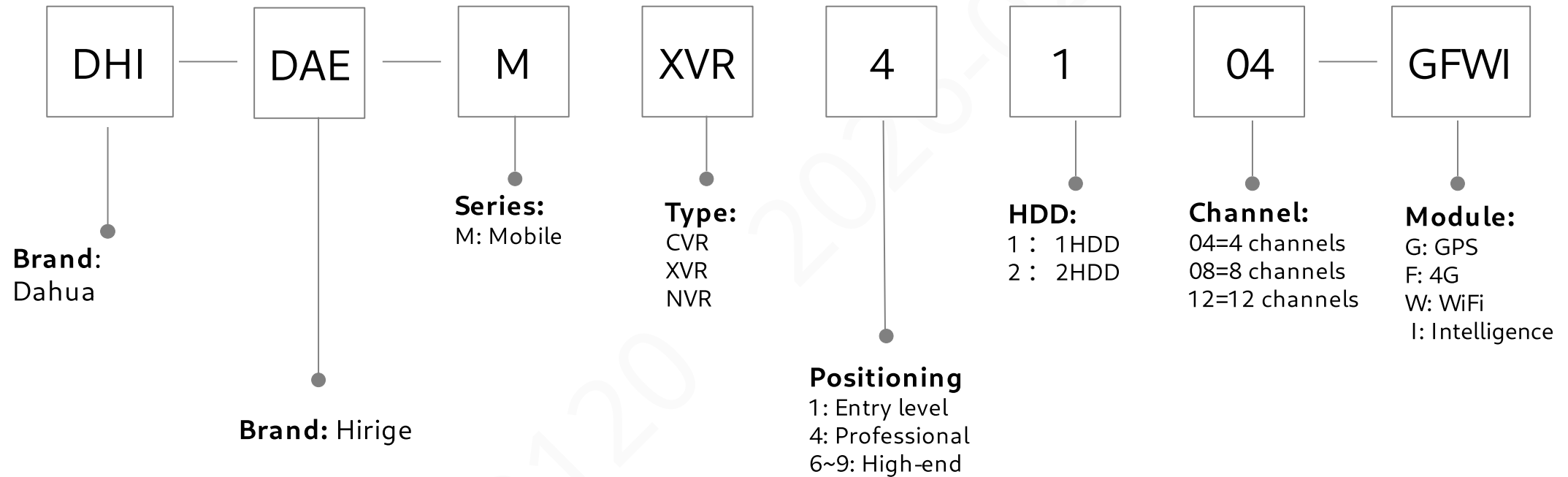

Mobile Active Safety Camera (1/2)

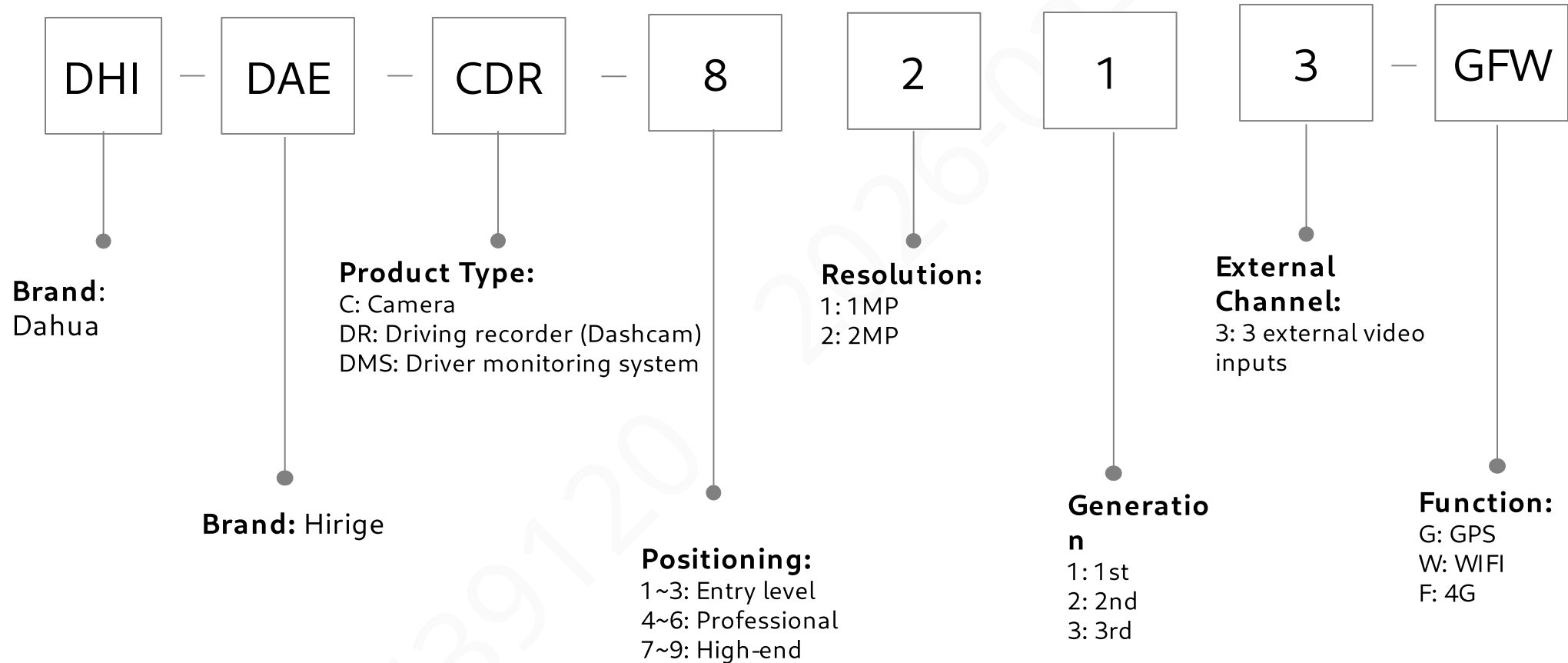

Mobile Active Safety Camera (2/2)

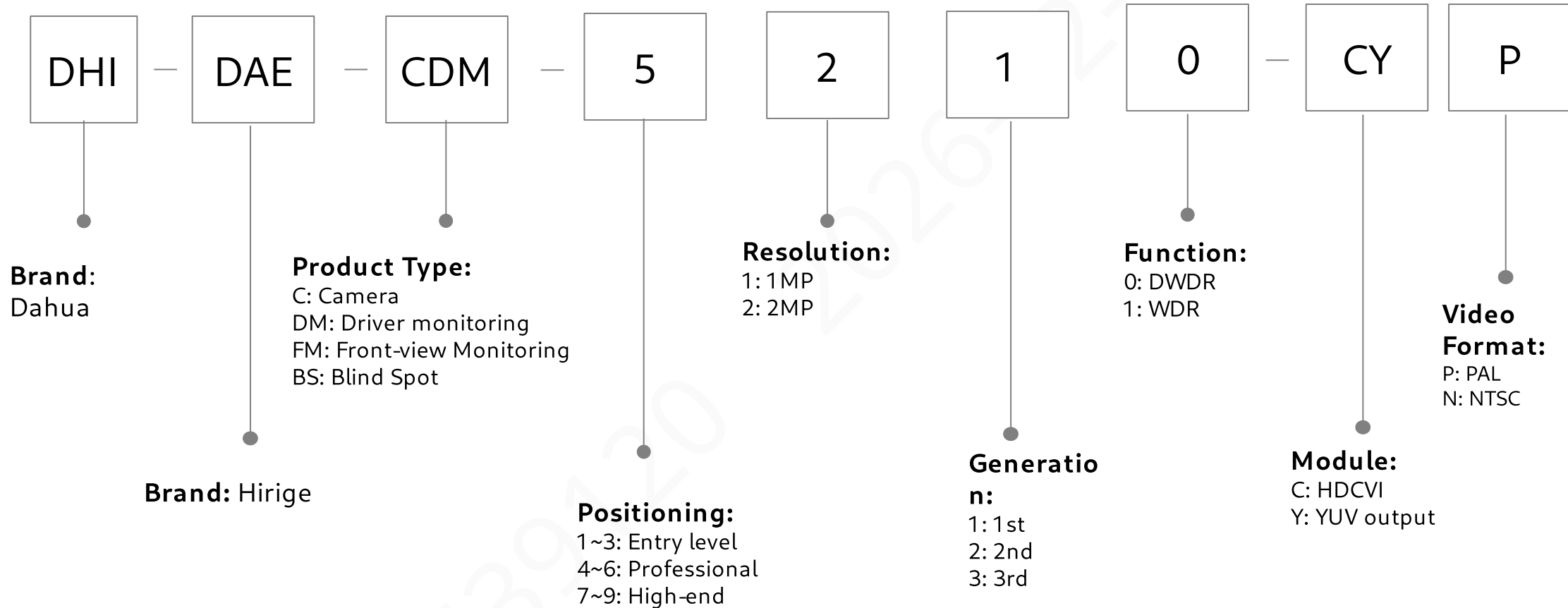

Residential Fire Alarm Series(New Gen)

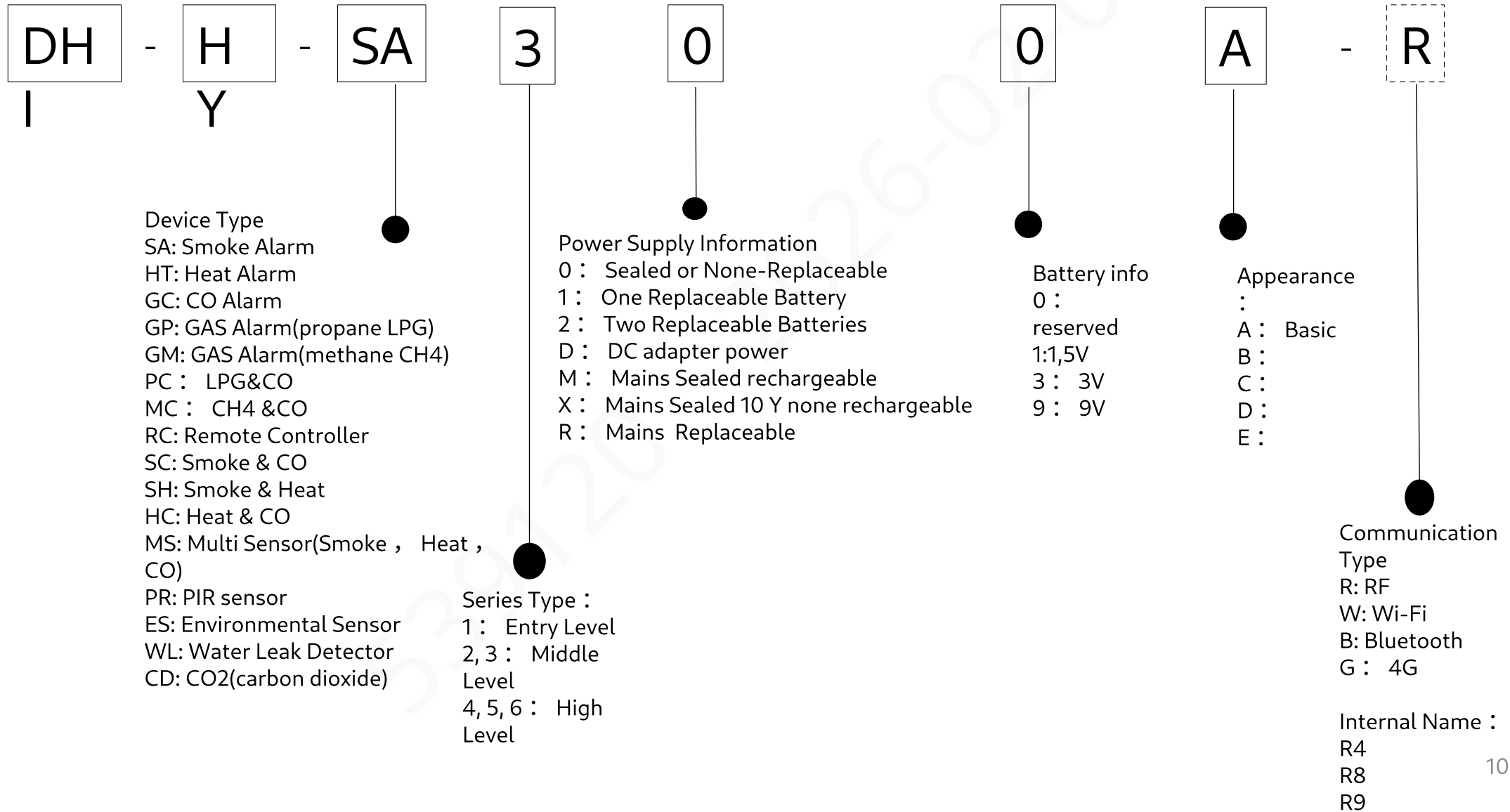

Commercial Fire Alarm Series (New Gen)

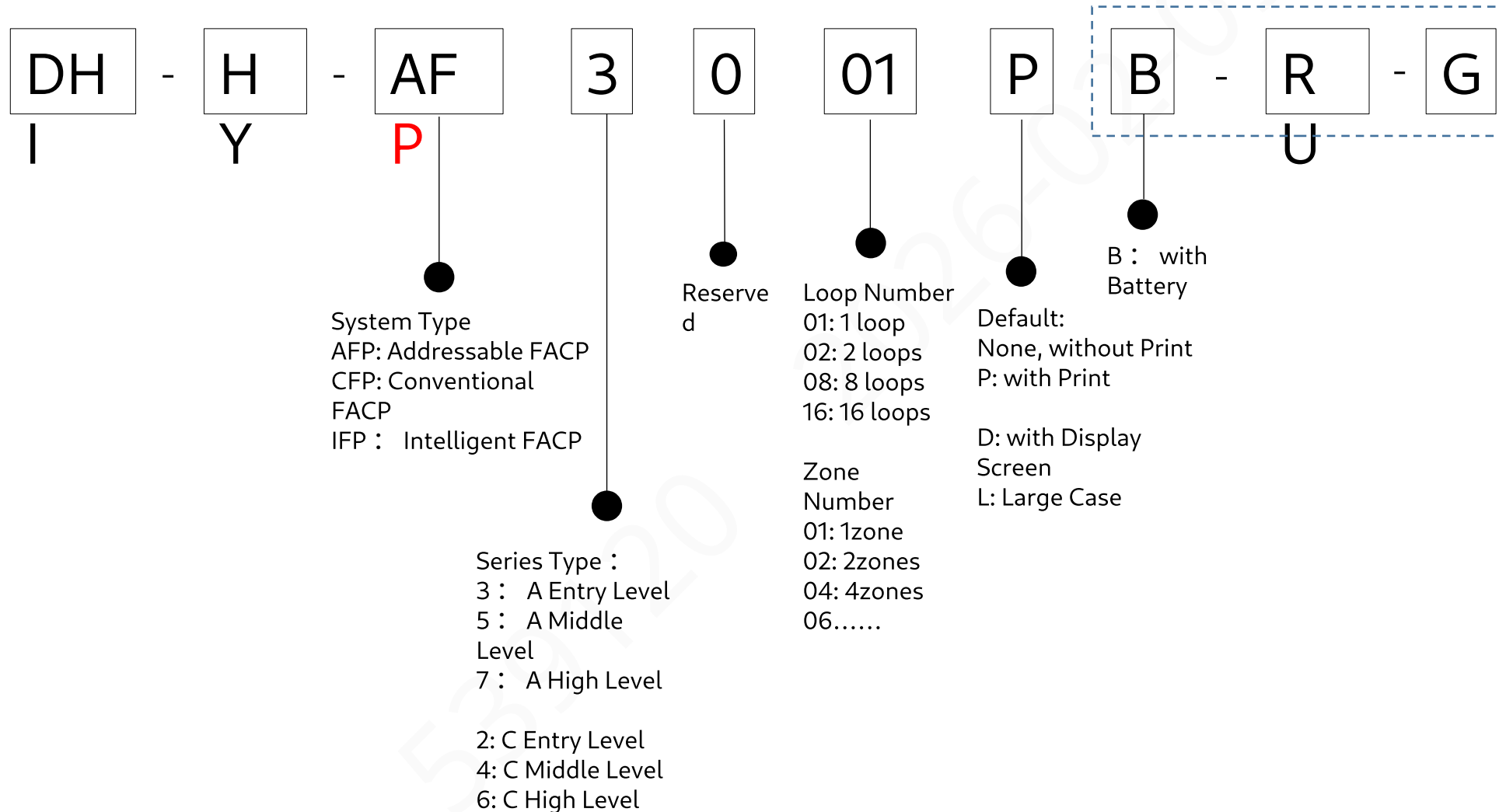

Commercial Fire Alarm Series (New Gen)

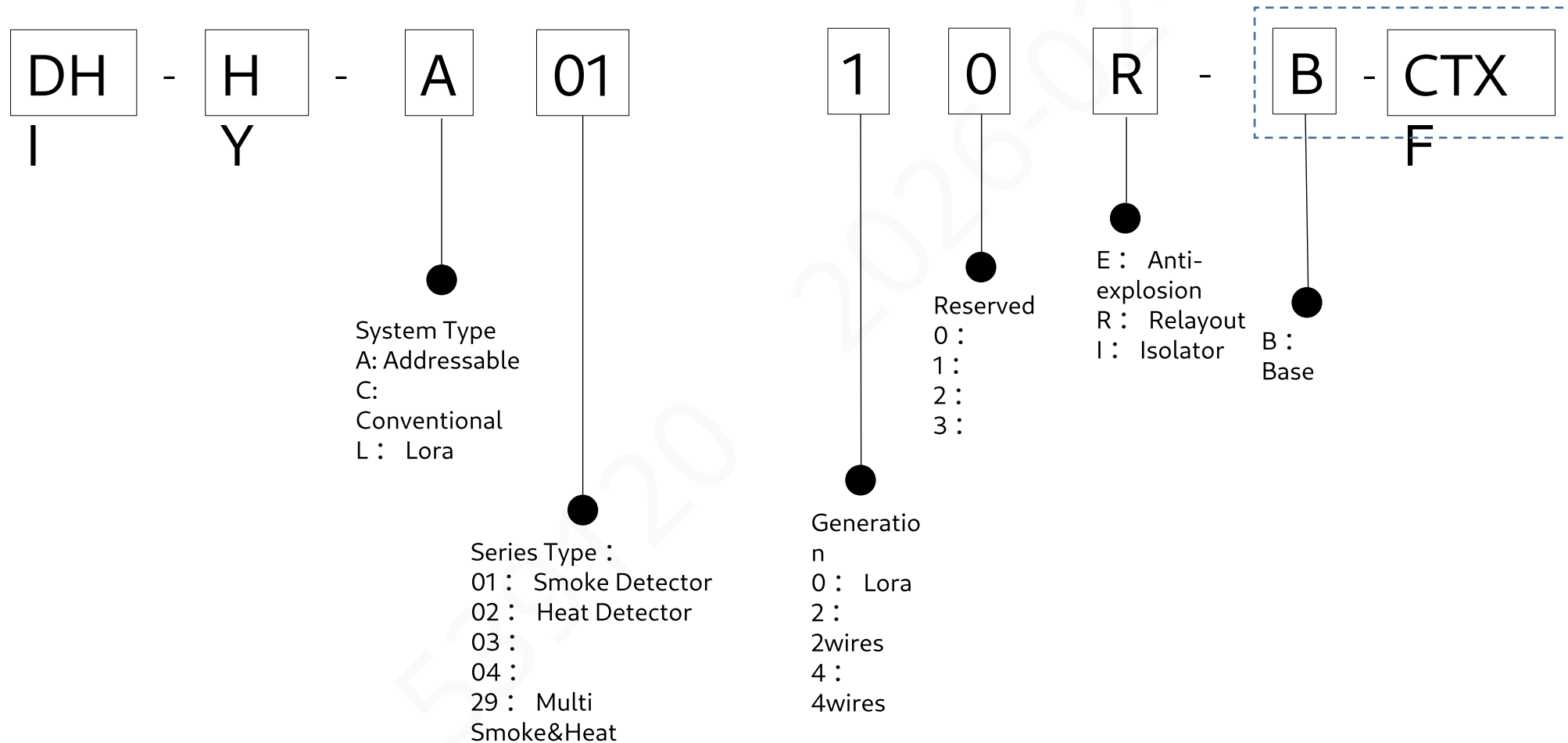

Microinverter

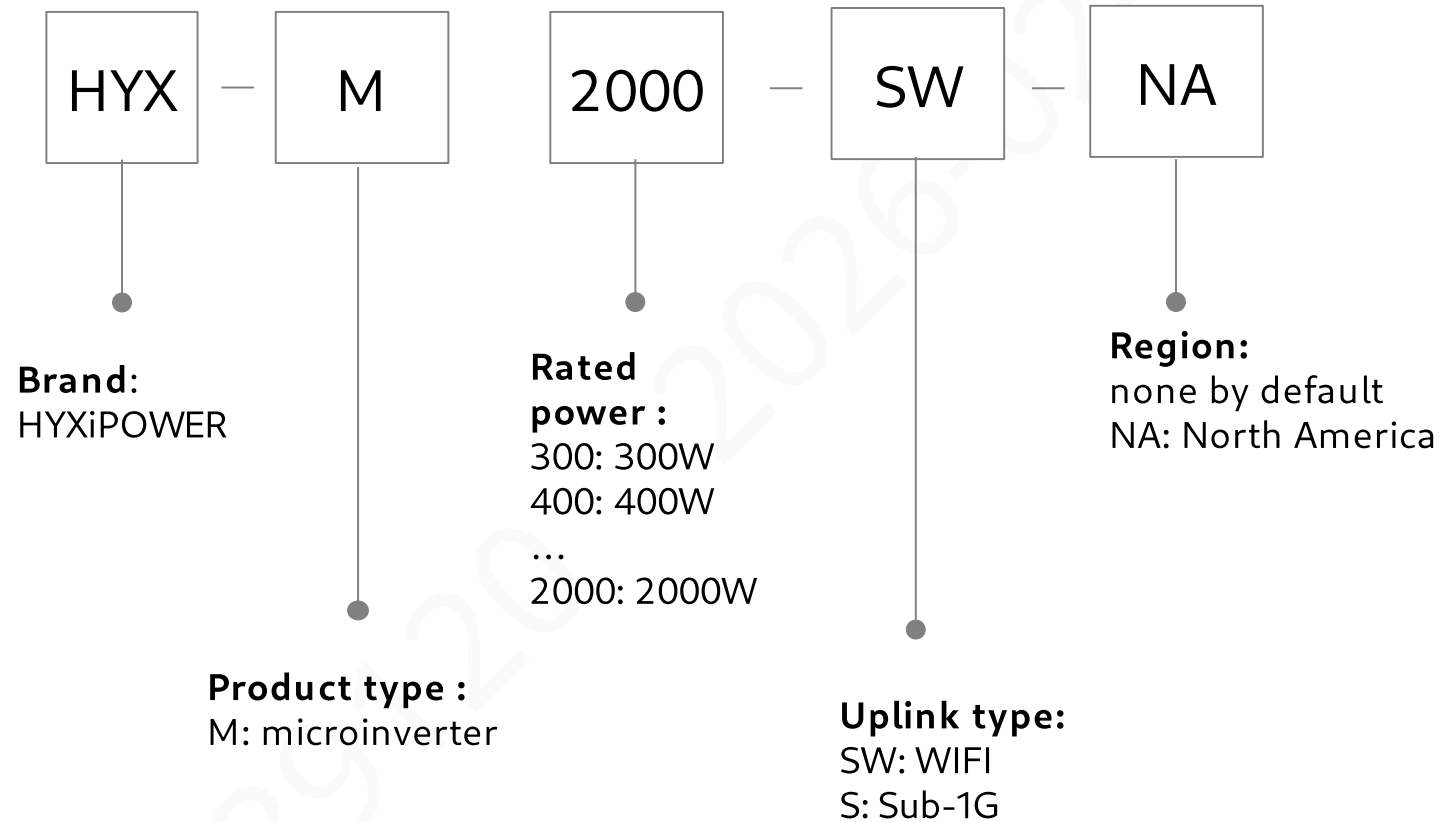

String Inverter

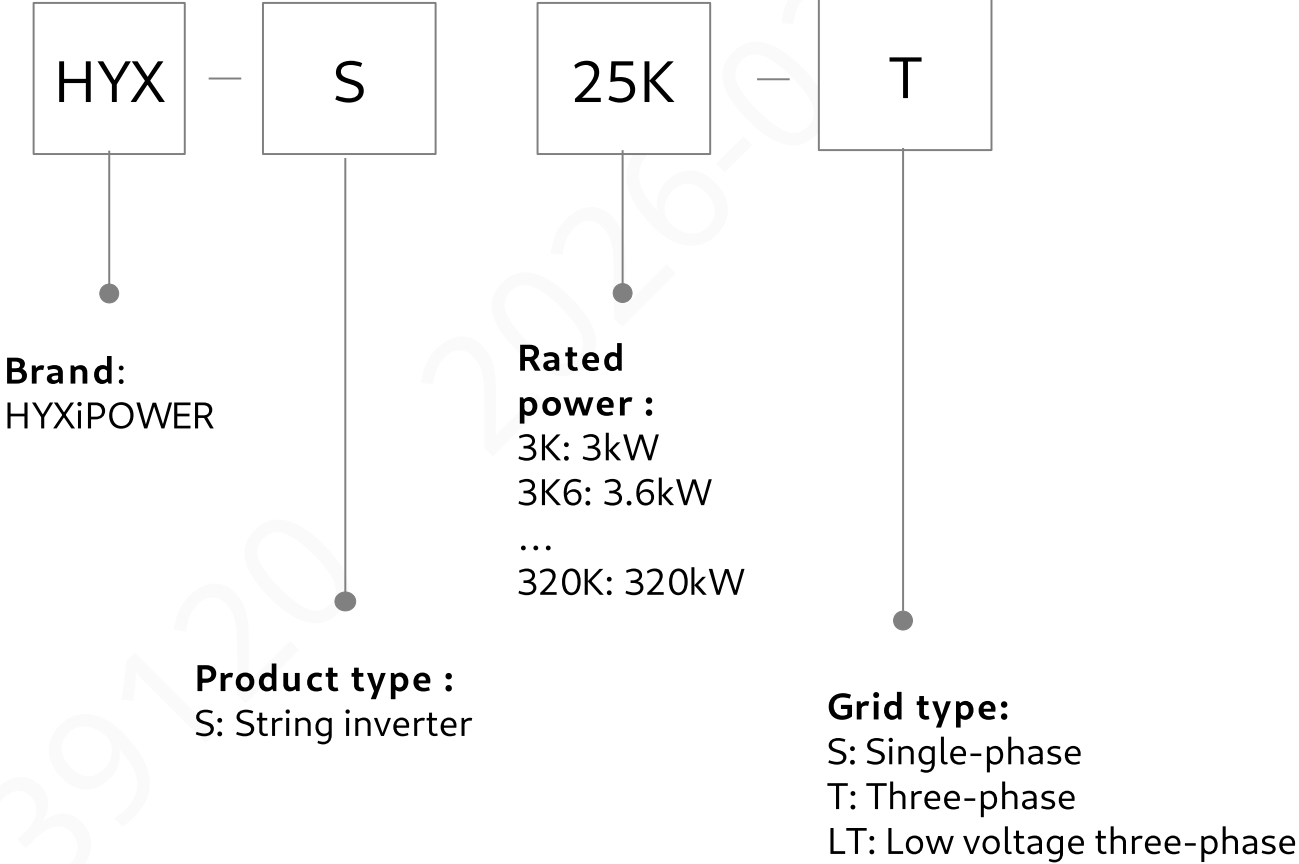

Hybrid Inverter

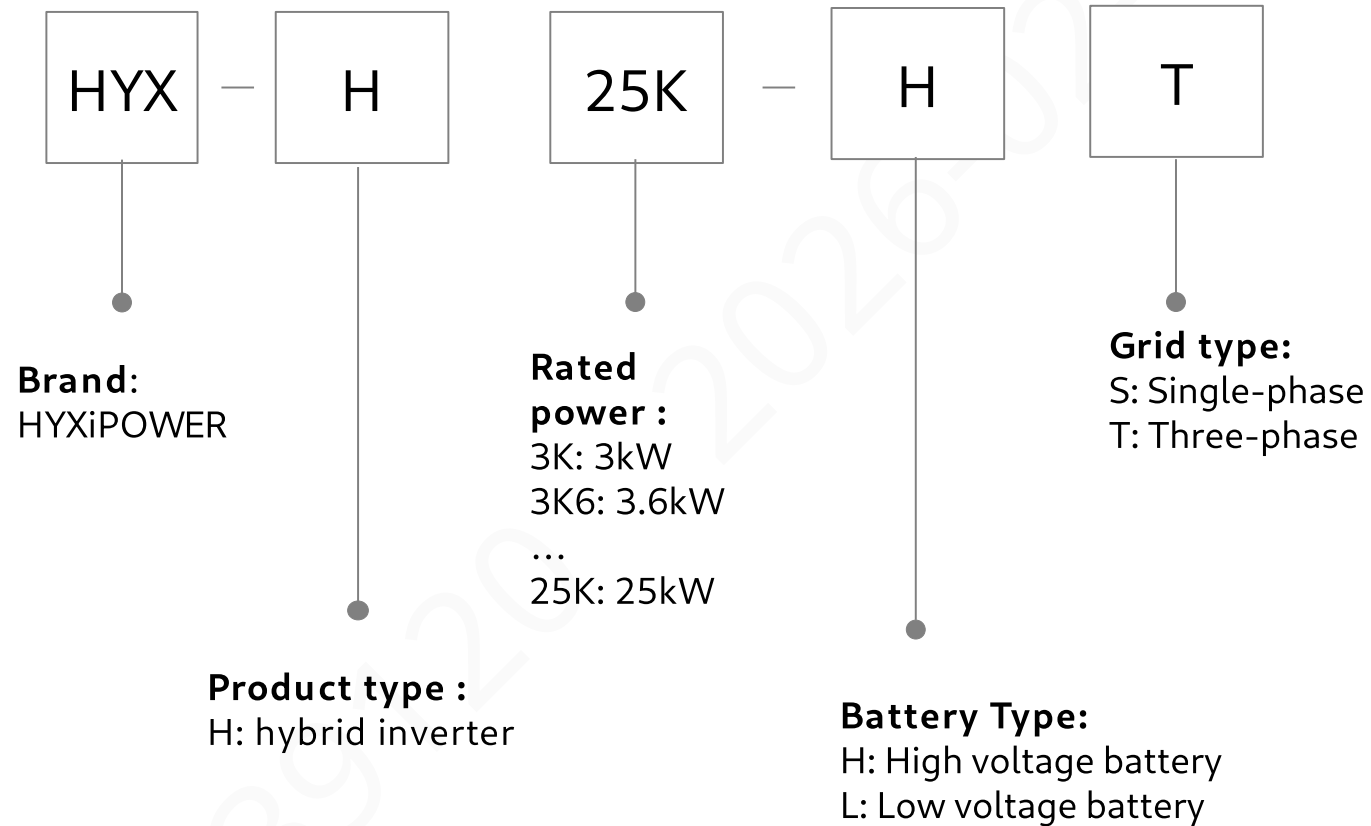

Residential Battery



Model Name



Brand:
HYXiPOWER

Product type:
E: Energy storage system

Sub type:
BDU: BDU unit
50B: 5kWh battery pack

BDU type:
P: Main BDU, only for two strings batteries
None for sub BDU

Battery Type:
H: High voltage battery
L: Low voltage battery

Generation:
2: 2nd generation
None for 1st generation

System Name



Brand:
HYXiPOWER

Product type:
E: Energy storage system

Battery capacity:
50: 5.3kWh, 1 pack
100: 10.6kWh, 2 packs
150: 15.9kWh, 3 packs
200: 21.2kWh, 4 packs

Battery Type:
H: High voltage battery
L: Low voltage battery

C&I ESS

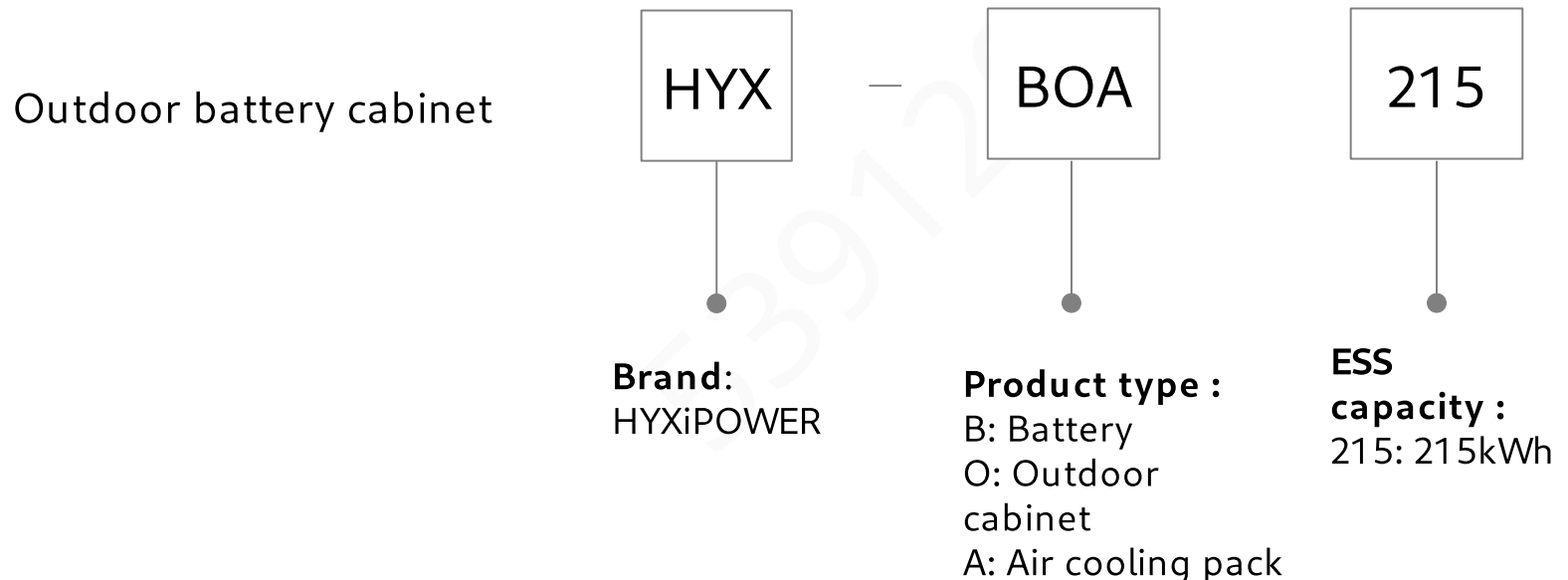
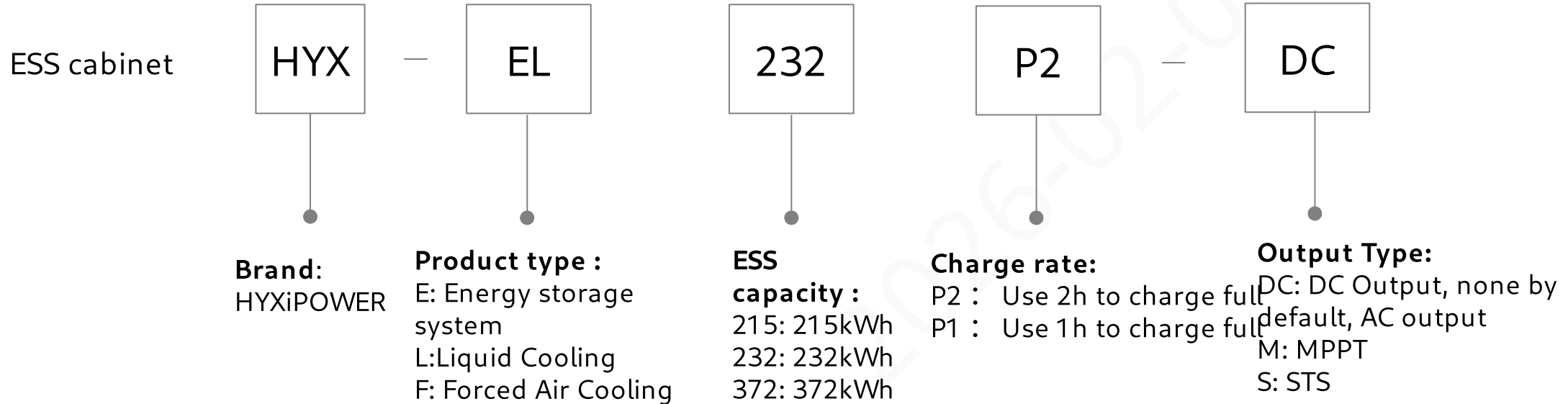

C&I ESS

Outdoor battery cabinet

HYX

—

BOA

215

Brand:
HYXiPOWER

Product type :
B: Battery
O: Outdoor
cabinet
A: Air cooling pack

**ESS
capacity :**
215: 215kWh