



# TURBO HD U7T Series Turret & Dome Camera User Manual

## User Manual

Thank you for purchasing our product. If there are any questions, or requests, do not hesitate to contact the dealer.

This manual applies to the models below:

Type	Model
Type I Camera	DS-2CE78U7T-IT1F
	DS-2CE78U7T-IT3F
Type II Camera	DS-2CE76U7T-ITMF
Type III Camera	DS-2CE57U7T-VPITF

This manual may contain technical incorrect places or printing errors, and the content is subject to change without notice. The updates will be added to the new version of this manual. We will readily improve or update the products or procedures described in the manual.

## Regulatory Information

### FCC Information

Please take attention that changes or modification not expressly approved by the party responsible for compliance could void the user's authority to operate the equipment.

**FCC compliance:** This equipment has been tested and found to comply with the limits for a Class A digital device, pursuant to part 15 of the FCC Rules. These limits are designed to provide reasonable protection against harmful interference when the equipment is operated in a commercial environment. This equipment generates, uses, and can radiate radio frequency energy and, if not installed and used in accordance with the instruction manual, may cause harmful interference to radio communications. Operation of this equipment in a residential area is likely to cause harmful interference in which case the user will be required to correct the interference at his own expense.

### FCC Conditions

This device complies with part 15 of the FCC Rules. Operation is subject to the following two conditions:

1. This device may not cause harmful interference.
2. This device must accept any interference received, including interference that may cause undesired operation.

### EU Conformity Statement



This product and - if applicable - the supplied accessories too are marked with "CE" and comply therefore with the applicable harmonized European standards listed under the Low Voltage Directive 2014/35/EU, the EMC Directive 2014/30/EU.



2012/19/EU (WEEE directive): Products marked with this symbol cannot be disposed of as unsorted municipal waste in the European Union. For proper recycling, return this product to your local supplier upon the purchase of equivalent new equipment, or dispose of it at designated collection points. For more information see: [www.recyclethis.info](http://www.recyclethis.info).



2006/66/EC (battery directive): This product contains a battery that cannot be disposed of as unsorted municipal waste in the European Union. See the product documentation for specific battery information. The battery is marked with this symbol, which may include lettering to indicate cadmium (Cd), lead (Pb), or mercury (Hg). For proper recycling, return the battery to your supplier or to a designated collection point. For more information, see: [www.recyclethis.info](http://www.recyclethis.info).

### Industry Canada ICES-003 Compliance

This device meets the CAN ICES-3 (A)/NMB-3(A) standards requirements.



## Safety Instruction

These instructions are intended to ensure that user can use the product correctly to avoid danger or property loss.

The precaution measure is divided into “Warnings” and “Cautions”.

**Warnings:** Serious injury or death may occur if any of the warnings are neglected.

**Cautions:** Injury or equipment damage may occur if any of the cautions are neglected.

	
<b>Warnings</b> Follow these safeguards to prevent serious injury or death.	<b>Cautions</b> Follow these precautions to prevent potential injury or material damage.



### Warnings

- In the use of the device, you must be in strict compliance with the electrical safety regulations of the nation and region.
- Input voltage should meet both the SELV (Safety Extra Low Voltage) and the Limited Power Source with 12 VDC according to the IEC60950-1 standard. Refer to technical specifications for detailed information.
- Do not connect multiple devices to one power adapter to avoid over-heating or a fire hazard caused by overload.
- Make sure that the plug is firmly connected to the power socket.
- Make sure that the device is firmly fixed if wall mounting or ceiling mounting is adopted.
- If smoke, odor or noise rise from the device, turn off the power at once and unplug the power cord, and then contact the service center.
- Never attempt to disassemble the camera by unprofessional personal.



### Cautions

- Do not drop the camera or subject it to physical shock.
- Do not place the camera in extremely hot, cold (the operating temperature shall be -40°C to 60°C), dusty or damp locations, and do not expose it to high electromagnetic radiation.
- Do not touch sensor modules with fingers.
- If cleaning is necessary, use clean cloth with a bit of ethanol and wipe it gently.
- Do not aim the camera at the sun or extra bright places.
- The sensor may be burned out by a laser beam, so when any laser equipment is in using, make sure that the surface of sensor will not be exposed to the laser beam.
- Do not expose the device to high electromagnetic radiation or extremely hot, cold, dusty or damp environment.
- To avoid heat accumulation, good ventilation is required for the operating environment.
- Keep the camera away from liquid while in use for non-water-proof device.

- While in delivery, the camera shall be packed in its original packing, or packing of the same texture.

## Mark Description

Table 0-1 Mark Description

Mark	Description
---	DC Voltage

# 1 Introduction

## 1.1 Product Features

The main features are as follows:

- IR cut filter with auto switch
- OSD menu with configurable parameters
- Auto white balance
- SMART IR
- 3-axis adjustment

## 1.2 Overview

This manual applies to two types of turret cameras, and one type of dome camera.

The overviews of each type are shown in the figures below.

### 1.2.1 Overview of Type I Camera

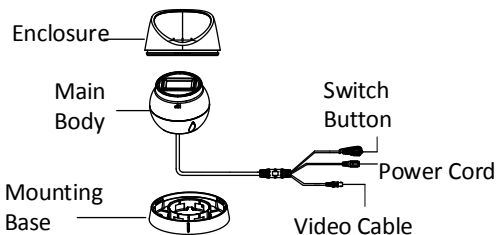

Figure 1-1 Overview of Type I Camera

#### **Note:**

Press and hold the switch button for 5 seconds to switch the video output. Four kinds of video outputs are available: TVI, AHD, CVI, and CVBS.

### 1.2.2 Overview of Type II Camera

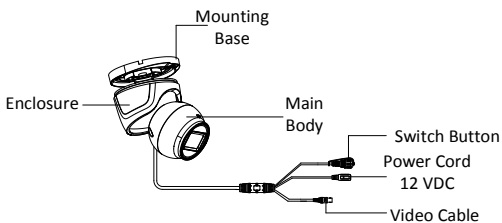

Figure 1-2 Overview of Type II Camera

#### **Note:**

Press and hold the switch button for 5 seconds to switch the video output. Four kinds of video outputs are available: TVI, AHD, CVI, and CVBS.

### 1.2.3 Overview of Type III Camera

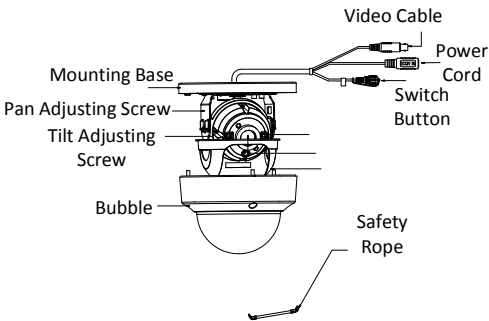

Figure 1-3 Overview of Type III Camera

#### Note:

Press and hold the switch button for 5 seconds to switch the video output. Four kinds of video outputs are available: TVI, AHD, CVI, and CVBS.

## 2 Installation

#### Before you start:

- Make sure that the device in the package is in good condition and all the assembly parts are included.
- Make sure that all the related equipment is power-off during the installation.
- Check the specification of the products for the installation environment.
- Check whether the power supply is matched with your required output to avoid damage.
- Make sure the wall is strong enough to withstand three times the weight of the camera and the bracket.
- If the wall is cement, insert expansion screws before installing the camera. If the wall is wooden, use self-tapping screw to secure the camera.
- If the product does not work properly, contact your dealer or the nearest service center. Do NOT disassemble the camera for repair or maintenance by yourself.

### 2.1 Installation of Type I Camera

#### Before you start:

Both wall mounting and ceiling mounting are suitable for the turret camera. Ceiling mounting will be taken as an example in this section. You can take steps of ceiling mounting as the reference, when adopting the wall mounting.

#### Steps:

1. Disassemble the turret camera by rotating the camera to align the notch to one of the marks, as shown in the figure below.

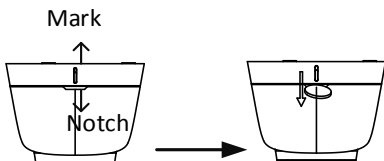

Figure 2-1 Disassemble the Camera

2. Pry the mounting base by using a flat object, e.g., a coin.

- Paste the drill template (supplied) to the place where you want to install the camera.
- Drill the screw holes and the cable hole (optional) on the ceiling/wall according to the drill template.

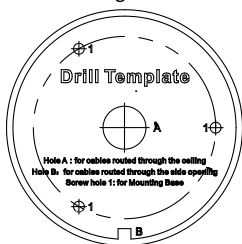

Figure 2-2 Drill Template

**Note:**

Drill the cable hole, when adopting the ceiling outlet to route the cable.

- Attach the mounting base to the ceiling/wall, and secure them with supplied screws.

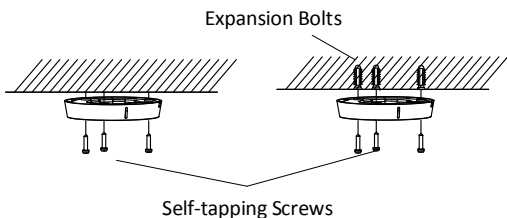

Figure 2-3 Attach the Mounting Base to the Ceiling

**Note:**

- The supplied screw package contains self-tapping screws, and expansion bolts.
  - For cement wall/ceiling, expansion bolts are required to fix the camera. For wooden wall/ceiling, self-tapping screws are required.
- Route the cables through the cable hole, or the side opening.
  - Install the camera to the mounting base, and tighten the screws to secure it on the mounting base.

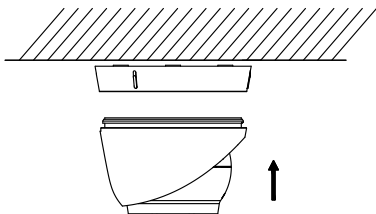

Figure 2-4 Install the Camera to the Mounting Base

- Connect the corresponding cables, such as power cord, and video cable.
- Power on the camera to check whether the image on the monitor is gotten from the optimum angle. If not, adjust the camera according to the figure below to get an optimum angle.

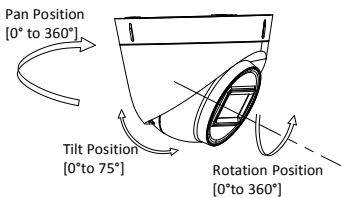

Figure 2-5 3-axis Adjustment

- 1). Hold the camera body and rotate the enclosure to adjust the pan position [0° to 360°].
- 2). Move the camera body up and down to adjust the tilt position [0° to 75°].
- 3). Rotate the camera body to adjust the rotation position [0° to 360°].

## 2.2 Installation of Type II Camera

### **Before you start:**

Both wall mounting and ceiling mounting are suitable for the turret camera. Ceiling mounting will be taken as an example in this section. You can take steps of ceiling mounting as the reference, when adopting the wall mounting.

### **Steps:**

1. Disassemble the turret camera by loosening the screw

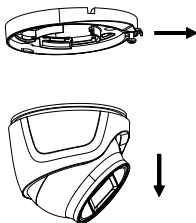

Figure 2-6 Disassemble the Camera

2. Remove the mounting base from the camera body.
3. Paste the drill template (supplied) to the place where you want to install the camera.
4. Drill the screw holes according to the drill template, and the cable hole (optional) on the ceiling.

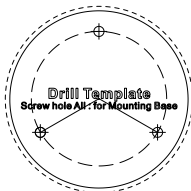

Figure 2-7 Drill Template

### **Note:**

Drill the cable hole in the center of the drill template, when adopting the ceiling outlet to route the cable.

5. Secure the mounting base to the ceiling with supplied screws.

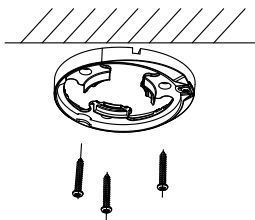

Figure 2-8 Secure the Mounting Base to the Ceiling

**Note:**

- The supplied screw package contains self-tapping screws, and expansion bolts.
  - For cement wall/ceiling, expansion bolts are required to fix the camera. For wooden wall/ceiling, self-tapping screws are required.
6. Route the cables through the cable hole, or the side opening.
  7. Secure the camera on the mounting base.
    - 1) Pull out the clip plate, and then to combine the camera with the mounting base.
    - 2) Push the clip plate in, and secure the camera by tightening the screw.

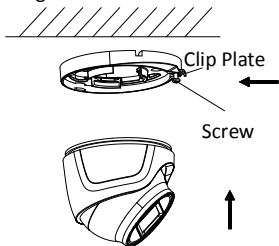

Figure 2-9 Secure the Camera

8. Connect the corresponding cables, such as power cord, and video cable.
9. Power on the camera to check whether the image on the monitor is gotten from the optimum angle. If not, adjust the camera according to the figure below to get an optimum angle.

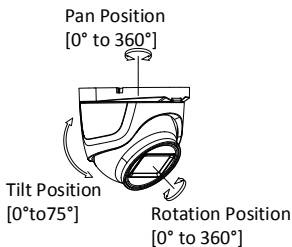

Figure 2-10 3-axis Adjustment

- 1). Hold the camera body and rotate the enclosure to adjust the pan position [0° to 360°].
- 2). Move the camera body up and down to adjust the tilt position [0° to 75°].
- 3). Rotate the camera body to adjust the rotation position [0° to 360°].

**Note:**

Loose the screw on the mounting base before adjusting the monitoring angle.



## 2.3 Ceiling Mounting of Type III Camera

### Steps:

1. Paste the drill template to the ceiling.
2. Drill the screw holes and cable hole (optional) in the ceiling according to the drill template.

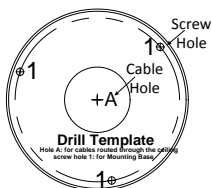

Figure 2-11 Drill Template

### Note:

Cable hole is required, when adopting the ceiling outlet to route cables.

3. Loosen the screws with a hex wrench (supplied) to remove the bubble.

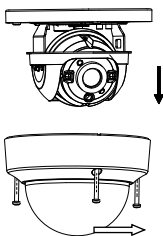

Figure 2-12 Remove the Bubble

4. Install the mounting base to the ceiling with supplied screws.

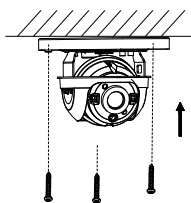

Figure 2-13 Install the Mounting Base

5. Route the cables through the cable hole, or the side opening.
6. Connect the corresponding cables.
7. Power on the camera to check whether the image on the monitor is gotten from the optimum angle. If not, adjust the camera according to the figure below to get an optimum angle.

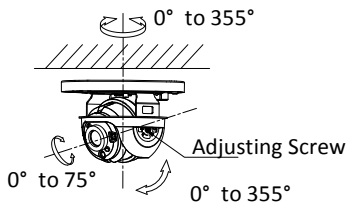

Figure 2-14 Type III Camera 3-Axis Adjustment

- 1). Loosen the tilt adjusting screw to adjust the tilt position [0° to 75°].
  - 2). Hold the black liner to adjust the pan position [0° to 355°].
  - 3). Hold the camera body to adjust the rotation position [0° to 355°].
8. Install the bubble back.

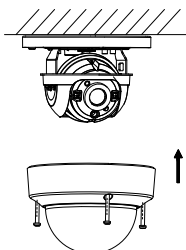

Figure 2-15 Install the Bubble back

9. Tighten screws to finish the installation.

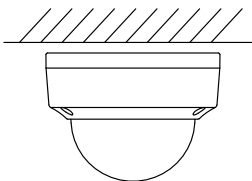

Figure 2-16 Finish the Installation

## 3 Menu Description

Please follow the steps below to call the menu.

**NOTE:**

Menu description part is only for your reference. It might have some differences due to the specific model that you have.

**Steps:**

1. Connect the camera with the TVI DVR, and the monitor, shown as the figure 3-1.

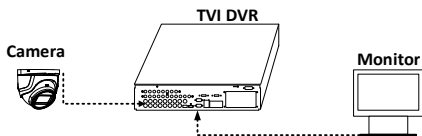



Figure 3-1 Connection

2. Power on the analog camera, TVI DVR, and the monitor to view the image on the monitor.
3. Click PTZ Control to enter the PTZ Control interface.
4. Call the camera menu by clicking  button, or call preset No. 95.

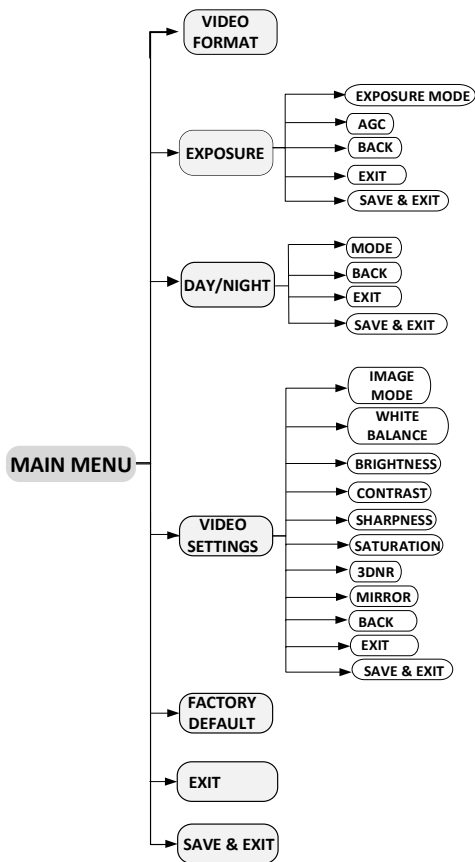

Figure 3-2 Main Menu Overview

5. Click the direction arrow to control the camera.
  - 1). Click up/down direction button to select the item.
  - 2). Click Iris + to confirm the selection.

- 3). Click left/right direction button to adjust the value of the selected item.

### 3.1 VIDEO FORMAT

You can set the video format as 8MP@12.5 fps, 8MP@15fps, 5MP@20fps, 4MP@25fps, 4MP@30fps, 1080P@25fps, and 1080P@30fps.

**Note:**

- When switching the video output as CVBS, you can set the video format as PAL, or NTSC.
- When switching the video output as AHD, you can set the video format as 8MP @12.5fps, or 8MP@15fps.
- When switching the video output as CVI, you can set the video format as 8MP@12.5 fps, or 8MP@15fps.

### 3.2 EXPOSURE

Exposure describes the brightness-related parameters, which can be adjusted by **EXPOSURE MODE**, and **AGC**.

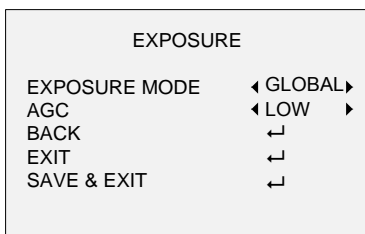

Figure 3-3 EXPOSURE

#### EXPOSURE MODE

You can set the **EXPOSURE MODE** as **GLOBAL**, **BLC**, **HLC**, and **WDR**.

- **GLOBAL**

**GLOBAL** refers to the normal exposure mode which performs exposure according to the whole image brightness.

- **BLC (Backlight Compensation)**

**BLC** (Backlight Compensation) compensates light for the front object to make it clear, but this may cause the over-exposure of the background, where the light is strong.

- **HLC (Highlight Compensation)**

**HLC** stands for highlight compensation. The camera detects the strong spots (the over-exposure portion of image), then reduce the brightness of the strong spots to improve the overall images.

- **WDR (Wide Dynamic Range)**

The **WDR** helps the camera provide clear images even under backlight circumstances. When both very bright and very dark areas simultaneously exist in the image, **WDR** balances the brightness level of the whole image to provide clear images with details.

#### **AGC (Automatic Gain Control)**

It optimizes the clarity of the image in poor light conditions. The **AGC** level can be set as **HIGH**, **MEDIUM**, or **LOW**.

**Note:**

The noise will be amplified when setting the **AGC** level.

### 3.3 DAY/NIGHT

**COLOR**, **BW** (Black White), and **AUTO** are selectable for DAY/NIGHT switch.

## COLOR

The image is colored in day mode all the time.

## B & W (Black and White)

The image is black and white all the time, and the **IR LIGHT** turns on in the poor light conditions.

You can turn on/off the **IR LIGHT** and set the value of **SMART IR** in this menu

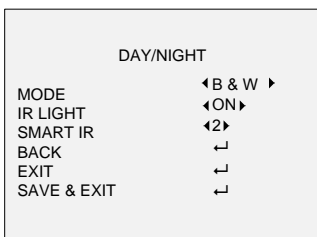

Figure 3-4 B & W

### ● IR LIGHT

You can turn on/off the **IR LIGHT** to meet the requirements of different circumstances.

### ● SMART IR

The **Smart IR** function is used to adjust the light to its most suitable intensity, and prevent the image from over exposure. The **SMART IR** value can be adjusted from 0 to 3. The higher the value is, the more obvious effects are.

## AUTO

Automatically switch Color, or BW (Black and White) according to actual scene brightness.

You can turn on/off the **IR LIGHT**, and set the value of **SMART IR** in this menu.

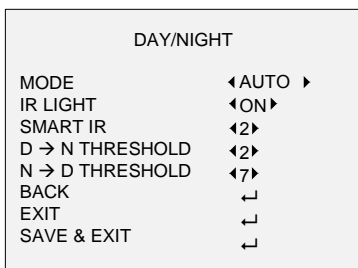

Figure 3-5 AUTO

### ● IR LIGHT

You can turn on/off the **IR LIGHT** to meet the requirements of different circumstances.

### ● SMART IR

The **Smart IR** function is used to adjust the light to its most suitable intensity, and prevent the image from over exposure. The **SMART IR** value can be adjusted from 0 to 3. The higher the value is, the more obvious effects are.

### ● D → N Threshold (Day to Night Threshold)

**Day to Night Threshold** is used to control the sensitivity of switching the day mode to the night mode. You can set the value from 1 to 9. The larger the value is, the more sensitive the camera is.

### ● N → D Threshold (Night to Day Threshold)

**Night to Day Threshold** is used to control the sensitivity of switching the night mode to the day mode. You can set

the value from 1 to 9. The larger the value is, the more sensitive the camera is.

### 3.4 VIDEO SETTINGS

Move the cursor to **VIDEO SETTINGS** and click **Iris+** to enter the submenu. **IMAGE MODE, WHITE BALANCE, BRIGHTNESS, CONTRAST, SHARPNESS, SATURATION, 3DNR,** and **MIRROR** are adjustable.

VIDEO SETTINGS	
IMAGE MODE	◀ STD ▶
WHITE BALANCE	↵
BRIGHTNESS	◀ 5 ▶
CONTRAST	◀ 5 ▶
SHARPNESS	◀ 5 ▶
SATURATION	◀ 5 ▶
3DNR	◀ 5 ▶
MIRROR	◀ OFF ▶
BACK	↵
EXIT	↵
SAVE & EXIT	↵

Figure 3-6 VIDEO SETTINGS

#### IMAGE MODE

**IMAGE MODE** is used to adjust the image saturation, and you can set it as **STD** (Standard), or **HIGH-SAT** (High Saturation).

#### WHITE BALANCE

White balance, the white rendition function of the camera, is to adjust the color temperature according to the environment. It can remove unrealistic color casts in the image. You can set the mode as **AUTO**, or **MANUAL**.

- **AUTO**

Under **AUTO** mode, white balance is being adjusted automatically according to the color temperature of the scene illumination.

- **MANUAL**

You can set the **R-GAIN/B-GAIN** value from 1 to 255 to adjust the shades of red/blue color of the image.

WHITE BALANCE	
MODE	◀ MANUAL ▶
R-GAIN	◀ 5 ▶
B-GAIN	◀ 5 ▶
BACK	↵
EXIT	↵
SAVE & EXIT	↵

Figure 3-7 MANUAL MODE

#### BRIGHTNESS

Brightness refers to the brightness of the image. You can set the **BRIGHTNESS** value from 1 to 9 to darken or brighten the image. The higher the value is, the brighter the image is.

#### CONTRAST

This feature enhances the difference in color and light between parts of an image. You can set the **CONTRAST** value from 1 to 9.

## **SHARPNESS**

Sharpness determines the amount of detail an imaging system can reproduce. You can set the **SHARPNESS** value from 1 to 9.

## **SATURATION**

Adjust this feature to change the saturation of the color. The value ranges from 1 to 9.

## **3 DNR (3D DNR)**

3 DNR refers to 3D digital noise reduction. You can set the **3D DNR** value from 1 to 9.

## **MIRROR**

**OFF**, **H**, **V**, and **HV** are selectable for mirror.

**OFF**: The mirror function is disabled.

**H**: The image flips 180° horizontally.

**V**: The image flips 180° vertically.

**HV**: The image flips 180° both horizontally and vertically.

## **3.5 FACTORY DEFAULT**

Move the cursor to **FACTORY DEFAULT** and click **Iris+** to reset all the settings to the factory default.

## **3.6 EXIT**

Move the cursor to **EXIT** and click **Iris+** to exit the menu without saving.

## **3.7 SAVE & EXIT**

Move the cursor to **SAVE & EXIT** and click **Iris+** to save the settings, and exit the menu.