



TURBO HD TVI Bullet & Turret Camera

User Manual

User Manual

Thank you for purchasing our product. If there are any questions, or requests, do not hesitate to contact the dealer.

This manual applies to the model listed below.

Type	Model
Type I	DS-2CE16D0T-IT1E/3E/5E
Type II	DS-2CE16D0T-IRE/IRPE
Type III	DS-2CE56D0T-IT1E/3E

This manual may contain several technically incorrect places or printing errors, and the content is subject to change without notice. The updates will be added to the new version of this manual. We will readily improve or update the products or procedures described in the manual.

0100001080423

Regulatory Information

FCC Information

FCC compliance: This equipment has been tested and found to comply with the limits for a Class A digital device, pursuant to part 15 of the FCC Rules. These limits are designed to provide reasonable protection against harmful interference when the equipment is operated in a commercial environment. This equipment generates, uses, and can radiate radio frequency energy and, if not installed and used in accordance with the instruction manual, may cause harmful interference to radio communications. Operation of this equipment in a residential area is likely to cause harmful interference in which case the user will be required to correct the interference at his own expense.

FCC Conditions

This device complies with part 15 of the FCC Rules. Operation is subject to the following two conditions:

1. This device may not cause harmful interference.
2. This device must accept any interference received, including interference that may cause undesired operation

EU Conformity Statement



This product and - if applicable - the supplied accessories too are marked with "CE" and comply therefore with the applicable harmonized European

standards listed under the EMC Directive 2014/30/EU, the RoHS Directive 2011/65/EU.



2012/19/EU (WEEE directive): Products marked with this symbol cannot be disposed of as unsorted municipal waste in the European Union. For proper recycling, return this product to your local supplier upon the purchase of equivalent new

equipment, or dispose of it at designated collection points. For more information see: www.recyclethis.info.

Industry Canada ICES-003 Compliance

This device meets the CAN ICES-3 (A)/NMB-3(A) standards requirements.

Warning

This is a class A product. In a domestic environment this product may cause radio interference in which case the user may be required to take adequate measures.



Safety Instruction

These instructions are intended to ensure that user can use the product correctly to avoid danger or property loss.

The precaution measure is divided into “Warnings” and “Cautions”

Warnings: Serious injury or death may occur if any of the warnings are neglected.

Cautions: Injury or equipment damage may occur if any of the cautions are neglected.

	
Warnings Follow these safeguards to prevent serious injury or death.	Cautions Follow these precautions to prevent potential injury or material damage.



Warnings

- In the use of the product, you must be in strict compliance with the electrical safety regulations of the nation and region.
- Refer to technical specifications for detailed information.
- Input voltage should meet both the SELV (Safety Extra Low Voltage) and the Limited Power Source with 12 V DC according to the IEC60950-1 standard. Refer to technical specifications for detailed information.
- Do not connect several devices to one power adapter as adapter overload may cause over-heating or a fire hazard.
- Make sure that the plug is firmly connected to the power socket.
- When the product is mounted on wall or ceiling, the device shall be firmly fixed.
- If smoke, odor or noise rise from the device, turn off the power at once and unplug the power cable, and then contact the service center.
- If the product does not work properly, contact your dealer or the nearest service center. Never attempt to disassemble the camera yourself. (We shall not assume any responsibility for problems caused by unauthorized repair or maintenance.)



Cautions

- Make sure the power supply voltage is correct before using the camera.
- Do not drop the camera or subject it to physical shock.
- Do not touch sensor modules with fingers. If cleaning is necessary, use clean cloth with a bit of ethanol and wipe it gently.
- Do not aim the camera at the sun or extra bright places. Blooming or smearing may occur otherwise (which is not a malfunction), and affect the endurance of sensor at the same time.

- The sensor may be burned out by a laser beam, so when any laser equipment is in using, make sure that the surface of sensor will not be exposed to the laser beam.
- Do not place the camera in extremely hot, cold, dusty or damp locations, and do not expose it to high electromagnetic radiation.
- To avoid heat accumulation, good ventilation is required for operating environment.
- Keep the camera away from liquid while in use.
- While in delivery, the camera shall be packed in its original packing, or packing of the same texture.

Chapter 1 Introduction

1.1 Product Features

The camera is applicable for both indoor and outdoor conditions, and the application scenarios include road, warehouse, parking lot, office, campus, etc..

The main features are as follows:

- High performance CMOS sensor
- 1080p resolution
- Auto white balance
- Auto electronic shutter
- Auto gain control (AGC)
- IR cut filter
- PoC
- 3-axis adjustment

Note:

Type III camera is applicable for indoor condition only.

1.2 Overview

1.2.1 Type I Camera Overview

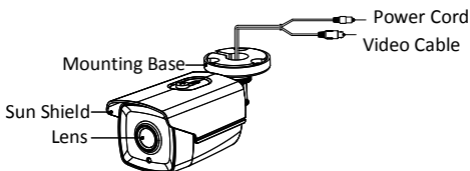

Figure 1. 1 Type I Camera Overview

1.2.2 Type II Camera Overview

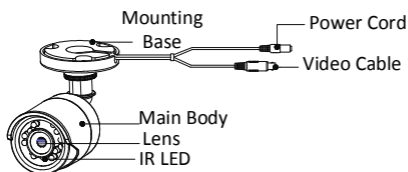

Figure 1. 2 Type II Camera Overview

1.2.3 Type III Camera Overview

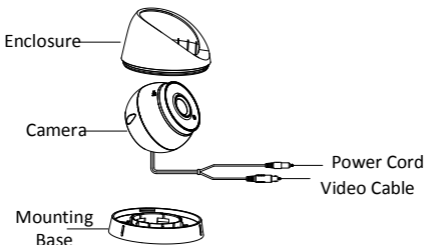

Figure 1. 3 Type III Camera Overview

Chapter 2 Installation

2.1 Installation Preparation

Before you start:

- Make sure that the device in the package is in good condition and all the assembly parts are included.
- Make sure that all the related equipment is power-off during the installation.
- Check the specification of the products for the installation environment.
- Check whether the power supply is matched with your power output to avoid damage.
- Make sure the wall is strong enough to withstand three times the weight of the camera and the mounting bracket.
- If the wall is cement, insert expansion bolts before installing the camera. If the wall is wooden, use self-tapping screws to secure the camera.
- If the product does not function properly, contact your dealer or the nearest service center. Do NOT disassemble the camera for repair or maintenance by yourself.

2.2 Installation of Type I Camera

Before you start:

Both wall mounting and ceiling mounting are suitable for the bullet camera. Ceiling mounting will be taken as an example in this section. You can take the steps of ceiling mounting as a reference, when adopting the wall mounting.

Steps:

1. Paste the drill template to the ceiling.
2. Drill the screw holes according to the drill template, and the cable hole (optional) on the ceiling.

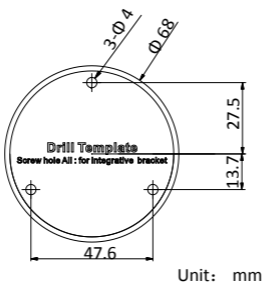

Figure 2. 1 Drill Template

Note:

Cable hole is required when adopting ceiling outlet to route the cable.

3. Attach the mounting base of the type I camera to the ceiling and secure the camera with supplied screws.

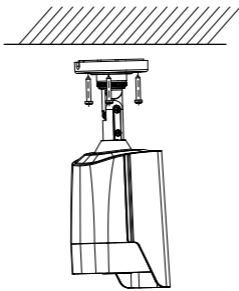

Figure 2. 2 Secure the Camera to the Ceiling

Note:

- The supplied screw package contains self-tapping screws, and expansion bolts.
 - For cement wall, expansion bolts are required to fix the camera. For wooden wall, self-tapping screws are required.
4. Route the cables through the cable hole (optional), or the side opening.
 5. Connect the corresponding power cord, and video cable.
 6. Power on the camera to check whether the image on the monitor is gotten from the optimum angle. If not, adjust the camera according to the figure below to get an optimum angle.

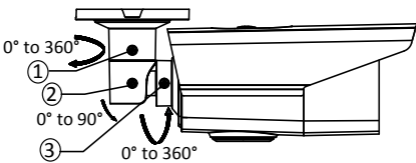

Figure 2. 3 3-Axis Adjustment

- 1) Loosen the No.1 adjusting screw to adjust the pan position (0° to 360°).
- 2) Tighten the No.1 adjusting screw.
- 3) Loosen the No.2 adjusting screw to adjust the tilting position (0° to 90°).
- 4) Tighten the No. 2 adjusting screw.
- 5) Loosen the No.3 adjusting screw to adjust the rotation position (0° to 360°).
- 6) Tighten the No.3 adjusting screw.

2.3 Installation of Type II Camera

Before you start:

Both wall mounting and ceiling mounting are suitable for the bullet camera. Ceiling mounting will be taken as an example in this section. You can take the steps of ceiling mounting as a reference, when adopting wall mounting.

Steps:

1. Paste the drill template to the ceiling.
2. Drill the screw holes according to the drill template, and the cable hole (optional) on the ceiling.

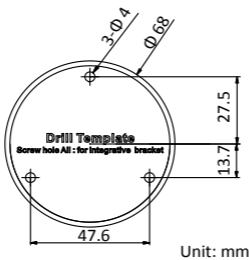

Figure 2. 4 Drill Template

Note:

Cable hole is required when adopting ceiling outlet to route the cable.

3. Attach the mounting base of the type I camera to the ceiling and secure the camera with supplied screws.

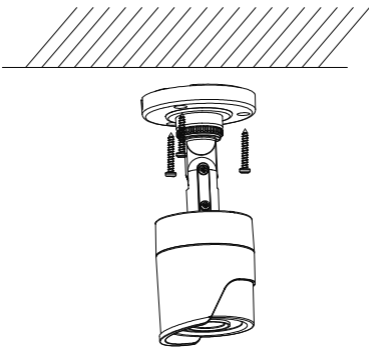

Figure 2. 5 Secure the camera to the ceiling

Note:

- The supplied screw package contains self-tapping screws, and expansion bolts.
 - For cement wall, expansion bolts are required to fix the camera. For wooden wall, self-tapping screws are required.
4. Route the cables through the cable hole (optional), or the side opening.
 5. Connect the corresponding power cord and video cable.
 6. Power on the camera to check whether the image on the monitor is gotten from the optimum angle. If not, adjust the camera according to the figure below to get an optimum angle.

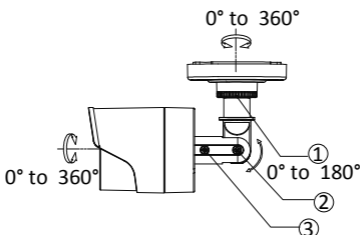

Figure 2. 6 3-Axis Adjustment

- 1). Loosen the No.1 adjusting screw to adjust the pan position (0° to 360°).
- 2). Tighten the No.1 adjusting screw.
- 3). Loosen the No.2 adjusting screw to adjust the tilting position (0° to 180°).
- 4). Tighten the No. 2 adjusting screw.
- 5). Loosen the No.3 adjusting screw to adjust the rotation position (0° to 360°).
- 6). Tighten the No.3 adjusting screw.

2.4 Installation of Type II camera

Before you start:

Both wall mounting and ceiling mounting are suitable for the turret camera. Ceiling mounting will be taken as an example in this section. You can take the steps of ceiling mounting as a reference, when adopting wall mounting.

Steps:

1. Disassemble the turret camera by rotating the camera to align the notch to one of the marks, as shown in Figure 2. 1.

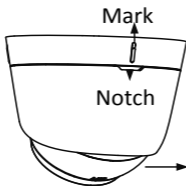

Figure 2. 7 Disassemble the Camera

2. Remove the mounting base from the camera body with a flat object, e.g., a coin.
3. Paste the drill template (supplied) to the place where you want to install the camera, and then drill the screw holes and the cable hole (optional) on the ceiling according to the drill template.

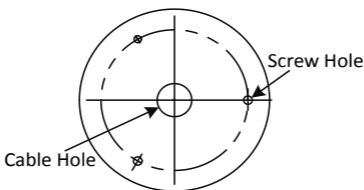

Figure 2. 8 Drill Template

Note:

Cable hole is required when adopting the ceiling outlet to route the cable.

4. Attach the mounting base to the ceiling and secure them with supplied screws

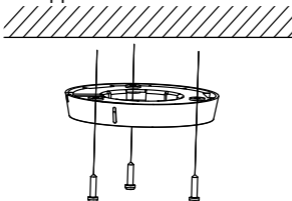

Figure 2. 9 Attach the Mounting Base to the Ceiling

Note:

- The supplied screw package contains self-tapping screws, and expansion bolts.
 - For cement wall, expansion bolts are required to fix the camera. For wooden wall, self-tapping screws are required.
5. Route the cables through the cable hole (optional), or the side opening.
 6. Align the camera with the mounting base, and tighten the screws to secure the camera with the mounting base.

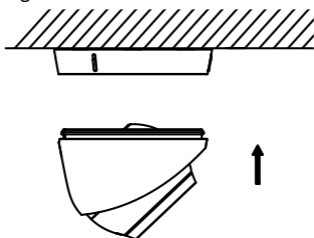

Figure 2. 10 Secure the Camera with Mounting Base

7. Connect the corresponding cables, such as power cord, and video cable.
8. Power on the camera to check whether the image on the monitor is gotten from the optimum angle. If not, adjust the camera according to the figure below to get an optimum angle.

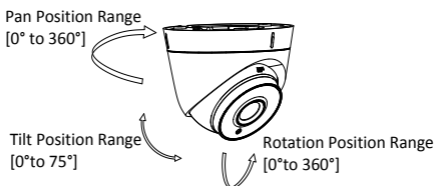



Figure 2. 11 3-axis Adjustment

- 1). Hold the camera body and rotate the enclosure to adjust the pan position [0° to 360°].
- 2). Move the camera body up and down to adjust the tilt position [0° to 75°].
- 3). Rotate the camera body to adjust the rotation position [0° to 360°].

Chapter 3 Menu Description

Purpose:

Call the menu by clicking button  on the PTZ Control interface, or call the preset No.95.

Steps:

1. Connect the camera with the TVI DVR, and the monitor, shown as the figure 3-1.

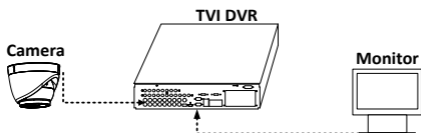



Figure 3. 1 Connection

2. Power on the analog camera, TVI DVR, and the monitor to view the image on the monitor.
3. Click PTZ Control to enter the PTZ Control interface.
4. Call the camera menu by clicking  button, or call the preset No. 95.

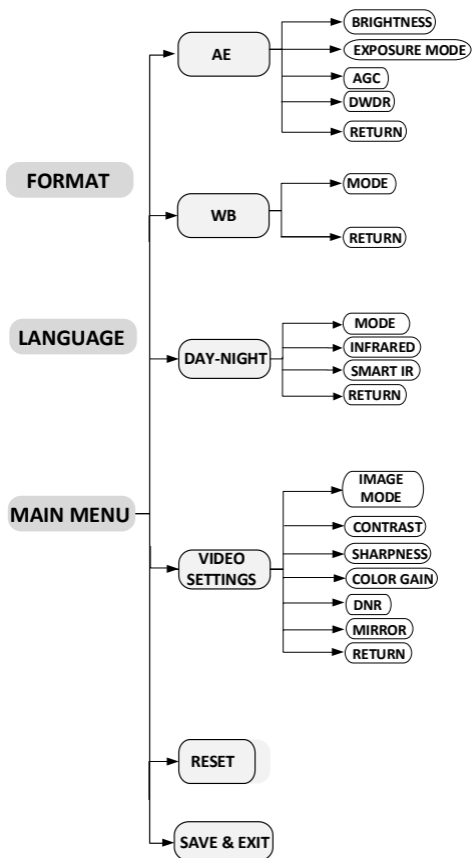

Figure 3. 2 Main Menu Overview

5. Click the direction arrow to control the camera.
- 7). Click up/down direction button to select the item.
- 8). Click Iris + to confirm the selection.
- 9). Click left/right direction button to adjust the value of the selected item.

3.1 VIDEO FORMAT

You can select the video format as 1080p@25fps , or 1080p@30fps.

3.2 LANGUAGE

Supports English, and Chinese.

3.3 MAIN MENU

3.3.1 EXPOSURE

You are allowed to set **BRIGHTNESS**, **EXPOSURE MODE**, **AGC**, and **DWDR**.

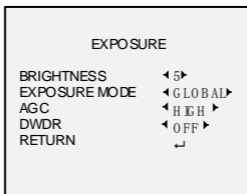

Figure 3. 3 EXPOSURE

BRIGHTNESS

Brightness refers to the brightness of the image. You can set the brightness value from 1 to 10 to darken or brighten the image. The greater the value is, the brighter the image is.

EXPOSURE MODE

You can set the **EXPOSURE MODE** as **GLOBAL**, or **BLC**.

- **GLOBAL**

GLOBAL refers to the normal exposure mode which adjusts lighting distribution, variations, and non-standard processing.

- **BLC (Backlight Compensation)**

BLC (Backlight Compensation) compensates light to the object in the front to make it clear, but this may cause the over-exposure of the background where the light is strong.

You can set the brightness value from 0 to 8 to darken or brighten the image. The greater the value is, the brighter the image is.

AGC (Auto Gain Control)

It optimizes the clarity of the image in poor light conditions. The **AGC** level can be set as **HIGH**, **MIDDLE**, or **LOW**. Select **OFF** to disable the **AGC** function.

Note:

The noise will be amplified when the **AGC** is on.

DWDR (Digital Wide Dynamic Range)

The digital wide dynamic range helps the camera provide clear images even under backlight circumstances. WDR balances the brightness level of the whole image and provides clear images with details.

3.3.2 WB (White Balance)

White balance, the white rendition function of the camera, is to adjust the color temperature according to the environment. It can remove unrealistic color casts in the image. You can set **WB** mode as **ATW**, or **MWB**.

- **ATW**

Under the **ATW** mode, white balance is being adjusted automatically according to the color temperature of the scene illumination.

- **MWB**

You can set the **RGAIN/BGAIN** value from 1 to 255 to adjust the shades of red/blue color of the image.

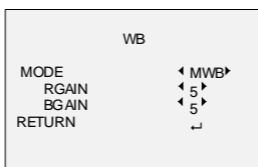

Figure 3. 4 MWB MODE

3.3.3 DAY/NIGHT

COLOR, **B/W** (Black White), and **SMART** are selectable for DAY and NIGHT switches.

COLOR

The image is colored in day mode all the time.

B/W

The image is black and white all the time.

SMART

The IR light turns on automatically as the environmental illumination becomes poor. You can set the value of **SMART IR** in this menu.

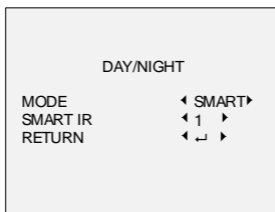

Figure 3. 5 DAY NIGHT

● **SMART IR**

The **Smart IR** function is used to adjust the light to its most suitable intensity, and prevent the image from over exposure. The **SMART IR** value can be adjusted from 0 to 3. The greater the value is, the more obvious effects are.

3.3.4 VIDEO SETTINGS

Move the cursor to **VIDEO SETTINGS** and click Iris+ to enter the submenu. **IMAGE MODE**, **CONTRAST**, **SHARPNESS**, **COLOR GAIN**, **DNR**, and **MIRROR** are adjustable.

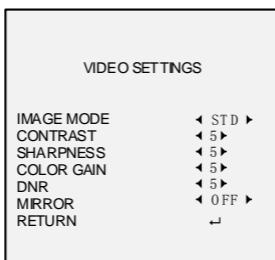

Figure 3. 6 VIDEO SETTINGS

IMAGE MODE

IMAGE MODE is used to adjust the image saturation, and you can set it as **STD** (Standard) or **HIGH-SAT** (High Saturation).

CONTRAST

This feature enhances the difference in color and light between parts of an image. You can set the **CONTRAST** value from 1 to 10.

SHARPNESS

Sharpness determines the amount of detail an imaging system can reproduce. You can set the **SHARPNESS** value from 1 to 10.

COLOR GAIN

Adjust this feature to change the gain of the color. The value ranges from 1 to 10.

DNR (Digital Noise Reduction)

The **DNR** function can decrease the noise effect, especially when capturing moving images in poor light conditions, and delivering more accurate and sharper image. You can set the **DNR** value from 1 to 9.

MIRROR

OFF, **H**, **V**, and **HV** are selectable for mirror.

OFF: The mirror function is disabled.

H: The image flips 180° horizontally.

V: The image flips 180° vertically.

HV: The image flips 180° both horizontally and vertically.

3.3.5 RESET

Reset all the settings to the factory default.

3.3.6 SAVE & EXIT

Move the cursor to **SAVE & EXIT**, and click Iris+ to save the settings, and exit the menu.