



Digital Video Recorder

User Manual

User Manual

COPYRIGHT ©2018 Hangzhou Hikvision Digital Technology Co., Ltd.

ALL RIGHTS RESERVED.

Any and all information, including, among others, wordings, pictures, graphs are the properties of Hangzhou Hikvision Digital Technology Co., Ltd. or its subsidiaries (hereinafter referred to be “Hikvision”). This user manual (hereinafter referred to be “the Manual”) cannot be reproduced, changed, translated, or distributed, partially or wholly, by any means, without the prior written permission of Hikvision. Unless otherwise stipulated, Hikvision does not make any warranties, guarantees or representations, express or implied, regarding to the Manual.

About this Manual

This Manual is applicable to Digital Video Recorder (DVR).

The Manual includes instructions for using and managing the product. Pictures, charts, images and all other information hereinafter are for description and explanation only. The information contained in the Manual is subject to change, without notice, due to firmware updates or other reasons. Please find the latest version in the company website (<http://overseas.hikvision.com/en/>).

Please use this user manual under the guidance of professionals.

Trademarks Acknowledgement

HIKVISION and other Hikvision’s trademarks and logos are the properties of Hikvision in various jurisdictions. Other trademarks and logos mentioned below are the properties of their respective owners.

Legal Disclaimer

TO THE MAXIMUM EXTENT PERMITTED BY APPLICABLE LAW, THE PRODUCT DESCRIBED, WITH ITS HARDWARE, SOFTWARE AND FIRMWARE, IS PROVIDED “AS IS”, WITH ALL FAULTS AND ERRORS, AND HIKVISION MAKES NO WARRANTIES, EXPRESS OR IMPLIED, INCLUDING WITHOUT LIMITATION, MERCHANTABILITY, SATISFACTORY QUALITY, FITNESS FOR A PARTICULAR PURPOSE, AND NON-INFRINGEMENT OF THIRD PARTY. IN NO EVENT WILL HIKVISION, ITS DIRECTORS, OFFICERS, EMPLOYEES, OR AGENTS BE LIABLE TO YOU FOR ANY SPECIAL, CONSEQUENTIAL, INCIDENTAL, OR INDIRECT DAMAGES, INCLUDING, AMONG OTHERS, DAMAGES FOR LOSS OF BUSINESS PROFITS, BUSINESS INTERRUPTION, OR LOSS OF DATA OR DOCUMENTATION, IN CONNECTION WITH THE USE OF THIS PRODUCT, EVEN IF HIKVISION HAS BEEN ADVISED OF THE POSSIBILITY OF SUCH DAMAGES.

REGARDING TO THE PRODUCT WITH INTERNET ACCESS, THE USE OF PRODUCT SHALL BE WHOLLY AT YOUR OWN RISKS. HIKVISION SHALL NOT TAKE ANY RESPONSIBILITIES FOR ABNORMAL OPERATION, PRIVACY LEAKAGE OR OTHER DAMAGES RESULTING FROM CYBER ATTACK, HACKER ATTACK, VIRUS INSPECTION, OR OTHER INTERNET SECURITY RISKS; HOWEVER, HIKVISION WILL PROVIDE TIMELY TECHNICAL SUPPORT IF REQUIRED.

SURVEILLANCE LAWS VARY BY JURISDICTION. PLEASE CHECK ALL RELEVANT LAWS IN YOUR JURISDICTION BEFORE USING THIS PRODUCT IN ORDER TO ENSURE THAT YOUR USE CONFORMS THE APPLICABLE LAW. HIKVISION SHALL NOT BE LIABLE IN THE EVENT THAT THIS PRODUCT IS USED WITH ILLEGITIMATE PURPOSES.

IN THE EVENT OF ANY CONFLICTS BETWEEN THIS MANUAL AND THE APPLICABLE LAW, THE LATER PREVAILS.

Regulatory Information

FCC Information

Please take attention that changes or modification not expressly approved by the party responsible for compliance could void the user's authority to operate the equipment.

FCC compliance: This equipment has been tested and found to comply with the limits for a Class A digital device, pursuant to part 15 of the FCC Rules. These limits are designed to provide reasonable protection against harmful interference when the equipment is operated in a commercial environment. This equipment generates, uses, and can radiate radio frequency energy and, if not installed and used in accordance with the instruction manual, may cause harmful interference to radio communications. Operation of this equipment in a residential area is likely to cause harmful interference in which case the user will be required to correct the interference at his own expense.

FCC Conditions

This device complies with part 15 of the FCC Rules. Operation is subject to the following two conditions:

1. This device may not cause harmful interference.
2. This device must accept any interference received, including interference that may cause undesired operation.

EU Conformity Statement

 This product and - if applicable - the supplied accessories too are marked with "CE" and comply therefore with the applicable harmonized European standards listed under the EMC Directive 2014/30/EU, the LVD Directive 2014/35/EU, the RoHS Directive 2011/65/EU.

 2012/19/EU (WEEE directive): Products marked with this symbol cannot be disposed of as unsorted municipal waste in the European Union. For proper recycling, return this product to your local supplier upon the purchase of equivalent new equipment, or dispose of it at designated collection points. For more information see: www.recyclethis.info

 2006/66/EC (battery directive): This product contains a battery that cannot be disposed of as unsorted municipal waste in the European Union. See the product documentation for specific battery information. The battery is marked with this symbol, which may include lettering to indicate cadmium (Cd), lead (Pb), or mercury (Hg). For proper recycling, return the battery to your supplier or to a designated collection point. For more information see: www.recyclethis.info

Industry Canada ICES-003 Compliance

This device meets the CAN ICES-3 (A)/NMB-3(A) standards requirements.

Applicable Models

This manual is applicable to the models listed in the following table.



| Series | Model |
|-----------------|--|
| DS-7200HGHI-K1 | DS-7216HGHI-K1 |
| DS-7200HGHI-K2 | DS-7216HGHI-K2 DS-7224HGHI-K2 DS-7232HGHI-K2 |
| DS-7100HQHI-K1 | DS-7104HQHI-K1 DS-7108HQHI-K1 DS-7116HQHI-K1 |
| DS-7200HQHI-K1 | DS-7204HQHI-K1 DS-7208HQHI-K1 DS-7216HQHI-K1 |
| DS-7200HQHI-K2 | DS-7208HQHI-K2 DS-7216HQHI-K2 DS-7224HQHI-K2 DS-7232HQHI-K2 |
| DS-7200HQHI-K/P | DS-7204HQHI-K1/P DS-7208HQHI-K2/P DS-7216HQHI-K2/P |
| DS-7300HQHI-K4 | DS-7304HQHI-K4 DS-7308HQHI-K4 DS-7316HQHI-K4 DS-7324HQHI-K4 DS-7332HQHI-K4 |
| DS-8100HQHI-K8 | DS-8124HQHI-K8 DS-8132HQHI-K8 |
| DS-7200HUHI-K1 | DS-7204HUHI-K1 |

| | |
|--------------------|--|
| | DS-7208HUHI-K1 |
| DS-7200HUHI-K2 | DS-7204HUHI-K2 DS-7208HUHI-K2 DS-7216HUHI-K2 |
| DS-7200HUHI-K/P | DS-7204HUHI-K1/P DS-7208HUHI-K2/P DS-7216HUHI-K2/P |
| DS-7300HUHI-K4 | DS-7304HUHI-K4 DS-7308HUHI-K4 DS-7316HUHI-K4 DS-7324HUHI-K4 DS-7332HUHI-K4 |
| DS-8100HUHI-K8 | DS-8108HUHI-K8 DS-8116HUHI-K8 DS-8124HUHI-K8 DS-8132HUHI-K8 |
| DS-9000HUHI-K8 | DS-9008HUHI-K8 DS-9016HUHI-K8 DS-9024HUHI-K8 DS-9032HUHI-K8 |
| DS-7200HTHI-K1 | DS-7204HTHI-K1 |
| DS-7200HTHI-K2 | DS-7204HTHI-K2 DS-7208HTHI-K2 |
| DS-7300HTHI-K4 | DS-7316HTHI-K4 |
| DS-8100HTHI-K8 | DS-8116HTHI-K8 |
| DS-9000HTHI-K8 | DS-9016HTHI-K8 |
| iDS-7200HQHI-K1/2S | iDS-7204HQHI-K1/2S |
| iDS-7200HQHI-K/4S | iDS-7208HQHI-K1/4S |

| | |
|---------------------|--|
| | iDS-7216HQHI-K1/4S iDS-7208HQHI-K2/4S iDS-7216HQHI-K2/4S |
| iDS-7200HUHI-K/4S | iDS-7204HUHI-K1/4S iDS-7208HUHI-K1/4S iDS-7204HUHI-K2/4S iDS-7208HUHI-K2/4S |
| iDS-7300HUHI-K4/16S | iDS-7316HUHI-K4/16S |
| iDS-9000HUHI-K8/16S | iDS-9016HUHI-K8/16S |

Symbol Conventions

The symbols that may be found in this document are defined as follows.

| Symbol | Description |
|--|---|
|  NOTE | Provides additional information to emphasize or supplement important points of the main text. |
|  WARNING | Indicates a potentially hazardous situation, which if not avoided, could result in equipment damage, data loss, performance degradation, or unexpected results. |
|  DANGER | Indicates a hazard with a high level of risk, which if not avoided, will result in death or serious injury. |

Safety Instructions

- Proper configuration of all passwords and other security settings is the responsibility of the installer and/or end-user.
- In the use of the product, you must be in strict compliance with the electrical safety regulations of the nation and region. Please refer to technical specifications for detailed information.
- Input voltage should meet both the SELV (Safety Extra Low Voltage) and the Limited Power Source with 100~240 VAC or 12 VDC according to the IEC60950-1 standard. Please refer to technical specifications for detailed information.
- Do not connect several devices to one power adapter as adapter overload may cause overheating or a fire hazard.
- Please make sure that the plug is firmly connected to the power socket.
- If smoke, odor or noise rise from the device, turn off the power at once and unplug the power cable, and then please contact the service center.

Preventive and Cautionary Tips

Before connecting and operating your device, please be advised of the following tips:

- Ensure unit is installed in a well-ventilated, dust-free environment.
- Unit is designed for indoor use only.
- Keep all liquids away from the device.
- Ensure environmental conditions meet factory specifications.
- Ensure unit is properly secured to a rack or shelf. Major shocks or jolts to the unit as a result of dropping it may cause damage to the sensitive electronics within the unit.
- Use the device in conjunction with an UPS if possible.
- Power down the unit before connecting and disconnecting accessories and peripherals.
- A factory recommended HDD should be used for this device.
- Improper use or replacement of the battery may result in hazard of explosion. Replace with the same or equivalent type only. Dispose of used batteries according to the instructions provided by the battery manufacturer.
- The USB interface can only connect to mouse, keyboard or USB flash drive.
- Use only power adaptors listed in the user instructions.

Product Key Features

General

- Connectable to Turbo HD and analog cameras;
- Supports UTC (Coaxitron) protocol for connecting camera over coax;
- Connectable to AHD cameras;
- Connectable to HDCVI cameras;
- Connectable to IP cameras;
- The analog signal inputs including Turbo HD, AHD, HDCVI, and CVBS can be automatically recognized without configuration;
- -K/P series DVR support PoC (Power over Coaxitron) cameras connection. DVR will detect the connected PoC cameras automatically, manage the power consumption via the coaxial communication, and provide power to the cameras via coaxitron;
- Each channel supports dual-stream. And sub-stream supports up to WD1 resolution;
- HQHI series DVR support up to 4 MP lite resolution of all the channels;
- HTHI, 7208/7216HUHI, 7300HUHI, 8100HUHI, 9000HUHI, iDS-7316HUHI-K4/16S and iDS-9016HUHI-K8/16S series DVR support up to 8 MP resolution of all the channels;
- 7204HUHI series DVR support up to 5 MP resolution of all the channels;
- For HUHI and HTHI series DVR, 5 MP long distance transmission can be enabled for the analog cameras;
- Independent configuration for each channel, including resolution, frame rate, bit rate, image quality, etc.;
- The minimum frame rate for main stream and sub-stream is 1 fps;
- Encoding for both video stream and video & audio stream; audio and video synchronization during composite stream encoding;
- Supports enabling H.265+/H.264+ to ensure high video quality with lowered bit rate;
- H.265 Pro+/H.265 Pro/H.265/H.264+/H.264 encoding for the main stream, and H.265/H.264 encoding for the sub-stream of analog cameras;
- Connectable to H.265 and H.264 IP cameras;
- For 7208/7216HUHI, 7300HUHI, 8100HUHI, and 9000HUHI series DVR, if the video encoding is H.264 or H.265, when 8 MP signal input is connected, H.264+ or H.265+ is disabled. If the video encoding is H.264+ or H.265+, when 8 MP signal input is connected, the video encoding will change to H.264 or H.265 automatically, and H.264+ or H.265+ is disabled;
- Defog level, night to day sensitivity, day to night sensitivity, IR light brightness, day/night mode, and WDR switch configurable for the connected analog cameras supporting these parameters;
- 4 MP/5 MP signal switch for the supported analog cameras;
- Watermark technology.

Local Monitoring

- For DS-7300/8100/9000HUHI-K, DS-7324/7332/8124/8132HQHI-K, DS-7300/8100/9000HTHI-K, iDS-7316HUHI-K4/16S and iDS-9016HUHI-K8/16S series, there are two HDMI interfaces of which the HDMI 1 and VGA interfaces share simultaneous output. For HDMI1/VGA output, up to 1920 × 1080 resolution is supported. For HDMI 2 output, up to 4K (3840 × 2160) resolution is supported;
- 1/4/6/8/9/16/25/36/64 screen live view is supported, and the display sequence of screens is adjustable;
- Live view screen can be switched in group and manual switch and automatic cycle live view are also provided, the interval of automatic cycle can be adjusted;
- CVBS output only serves as the aux output or live view output.
- Quick setting menu is provided for live view;
- The selected live view channel can be shielded;
- Except for iDS-7200HQHI-K/S and iDS-7200HUHI-K/S series, for HUHI, HTHI, iDS-7316HUHI-K4/16S and iDS-9016HUHI-K8/16S series DVR, VCA information overlay in live view for the supported analog cameras and in smart playback for the supported analog and IP cameras;
- Motion detection, video-tampering detection, video exception alarm, video loss alarm and VCA alarm functions;
- For DS-7300/8100/9000HUHI-K and DS-7300/8100/9000HTHI-K series DVR, analog channel supports 1-ch people counting function and heat map function;
- iDS-7316HUHI-K4/16S and iDS-9016HUHI-K8/16S series DVR supports false alarm filtering and picture re-recognition for up to 16-ch behavior (line crossing and intrusion) detection;
- iDS-7316HUHI-K4/16S and iDS-9016HUHI-K8/16S series DVR supports false alarm filtering and picture re-recognition for human body or vehicle target detection;
- iDS-7200HQHI-K/S and iDS-7200HUHI-K/S series support deep learning-based analysis: re-recognition of the human body or vehicle target in behavior detection to filter false alarm, supports 2-ch detection for iDS-7204HQHI-K1/2S, 4-ch for iDS-7208HQHI-K1/4S, 4-ch for iDS-7200HQHI-K2/4S, 4-ch for iDS-7200HUHI-K1/4S, 4-ch for iDS-7200HUHI-K2/4S series;
- -K/P series DVR can detect the PoC module exception. When it cannot detect the PoC module or the PoC module is powered off abnormally, alarms are triggered, and linkage methods are configurable;
- HGHI series support only 1-ch line crossing detection and intrusion detection. HTHI series DVR support full-channel line crossing detection and intrusion detection, and 2-ch sudden scene change detection. For HUHI series DVR(except iDS-7200HUHI-K/S series), if enhanced VCA mode is enabled, full-channel line crossing detection and intrusion detection, and 2-ch sudden scene change detection are supported, but 2K/4K output and 4 MP/5 MP/8 MP signal input are not supported; if enhanced VCA mode is disabled, 2-ch line crossing detection and intrusion detection, and 2-ch sudden scene change detection are supported, and 2K/4K output and 4 MP/5 MP/8 MP signal input are also supported. DS-7200HQHI series support up to 4-ch line crossing detection and intrusion detection if enhanced VCA mode is enabled. And DS-7216/7224/7232HQHI series DVR also support 1-ch sudden scene change detection. DS-

7300/8100HQHI-K series DVR support up to 4-ch line crossing detection and intrusion detection if enhanced VCA mode is enabled, and 1-ch sudden scene change detection. For HQHI series DVR, the enhanced VCA mode also conflicts with the 2K/4K output and 4 MP/5 MP/8 MP signal input. For the analog channels, the line crossing detection and intrusion detection conflict with other VCA detection such as sudden scene change detection, face detection and vehicle detection. You can only enable one function;

- Privacy mask;
- Zooming in/out by clicking the mouse and PTZ tracing by dragging mouse;
- When Hikvision CVBS camera is connected, you can control PTZ via Coaxitron and call the OSD of the camera.

HDD Management

- Each disk with a maximum of 10 TB storage capacity for HTHI, HUHI, HGHI, DS-7200/7300/8100HQHI, iDS-7316HUHI-K4/16S and iDS-9016HUHI-K8/16S series DVR.
Each disk with a maximum of 6 TB storage capacity for DS-7100HQHI-K1;
- Up to 8 network disks (8 NAS disks, 8 IP SAN disks or n NAS disks + m IP SAN disks ($n+m \leq 8$)) can be connected for HQHI/HUHI/HTHI-K8 series;
- Remaining recording time of the HDD can be viewed;
- Supports cloud storage (except HGHI-K series);
- S.M.A.R.T. and bad sector detection;
- HDD sleeping function;
- HDD property: redundancy, read-only, read/write (R/W);
- HDD group management;
- HDD quota management; different capacity can be assigned to different channels.
- For DS-7300/8100/9000HUHI-K and DS-7300/8100/9000HTHI-K series, hot-swappable HDD supporting RAID0, RAID1, RAID5, RAID 6 and RAID10 storage scheme, and can be enabled and disabled on your demand. And 16 arrays can be configured.

Recording, Capture and Playback



NOTE

Capture is supported by DS-7300/8100/9000HUHI-K, DS-7300/8100/9000HTHI-K, iDS-7316HUHI-K4/16S and iDS-9016HUHI-K8/16S series DVR only.

- Holiday recording schedule configuration;
- Cycle and non-cycle recording modes;
- Normal and event video encoding parameters;
- Multiple recording types: manual, continuous, alarm, motion, motion | alarm, motion & alarm and event;
- The device will note that the exported AVI video may have problems if the frame rates of the continuous and event recording are different;

- Supports POS triggered recording for DS-7300/8100HQHI, DS-7300/8100/9000HUHI-K, DS-7300/8100/9000HTHI-K, iDS-7316HUHI-K4/16S and iDS-9016HUHI-K8/16S series DVR;
- 8 recording time periods with separated recording types;
- Supports Channel-Zero encoding (except DS-7216HGHI-K1 and DS-7216HGHI-K2);
- Main stream and sub-stream configurable for simultaneous recording (except HGHI-K series);
- Pre-record and post-record for motion detection triggered recording, and pre-record time for schedule and manual recording;
- Searching record files and captured pictures by events (alarm input/motion detection);
- Customization of tags, searching and playing back by tags;
- Locking and unlocking of record files;
- Local redundant recording and capture;
- When Turbo HD, AHD, or HDCVI input is connected, the information including the resolution and frame rate will be overlaid on the bottom right corner of the live view for 5 seconds. When CVBS input is connected, the information such as NTSC or PAL will be overlaid on the bottom right corner of the live view for 5 seconds.
- Searching and playing back record files by camera number, recording type, start time, end time, etc.;
- Smart playback to go through less effective information;
- Zooming in for any area when playback;
- Multi-channel reverse playback;
- Supports pause, fast forward, slow forward, skip forward, and skip backward when playback, locating by dragging the mouse on the progress bar;
- 4/8/16-ch synchronous playback;
- Manual capture, continuous capture of video images and playback of captured pictures.

Backup

- Exports data by a USB, and SATA device;
- Exports video clips when playback;
- Video and Log and Player are selectable to export for backup;
- Management and maintenance of backup devices.

Alarm and Exception

- Configurable arming time of alarm input/output;
- Alarms for video loss, motion detection, video tampering, illegal login, network disconnected, IP confliction, record/capture exception, HDD error, and HDD full, etc.;
- Alarm triggers full screen monitoring, audio alarm, notifying surveillance center, sending email and alarm output;
- One-key disarms the linkage actions of the alarm input;
- PTZ linking for the VCA alarm;

- VCA detection alarm is supported except DS-7100 series;
- Supports POS triggered alarm;
- Supports coaxial alarm;
- System will automatically reboot when a problem is detected in an attempt to restore normal functionality;
- You can enable false alarm filter for the motion detection of the PIR cameras. Then only when the motion detection events and PIR events are both triggered, the motion detection alarm will be triggered.

Other Local Functions

- Operable by mouse and remote control;
- Three-level user management; admin user can create many operating account and define their operating permission, which includes the permission to access any channel;
- Completeness of operation, alarm, exceptions and log writing and searching;
- Manually triggering and clearing alarms;
- Importing and exporting of configuration file of devices;
- Getting cameras type information automatically;
- Unlock pattern for device login for the *admin*;
- Clear-text password available;
- GUID file can be exported for password resetting;
- Security question and reserved email can be configured for password resetting;
- Multiple connected analog cameras supporting Turbo HD or AHD signal can be upgraded simultaneously via DVR.

Network Functions

- Self-adaptive 100M or 1000M network interface;
- IPv6 is supported;
- TCP/IP protocol, PPPoE, DHCP, DNS, DDNS, NTP, SADP, SNMP (for 7304/7308/7316HQHI/HUHI and 9008/9016HUHI and DS-7300/8100/9000HTHI-K series DVR), SMTP, NFS, iSCSI, UPnP™ and HTTPS are supported;
- Supports access by Hik-Connect. If you enable Hik-Connect, the device will remind you the internet access risk and ask you to confirm the “Terms of Service” and “Privacy Statement” before enabling the service. You should create a verification code to connect to the Hik-Connect;
- TCP, UDP and RTP for unicast;
- Auto/Manual port mapping by UPnP™;
- Remote search, playback, download, locking and unlocking the record files, and downloading files broken transfer resume;
- Remote parameters setup; remote import/export of device parameters;

- Remote viewing of the device status, system logs and alarm status;
- Remote keyboard operation;
- Remote HDD formatting and program upgrading;
- Remote system restart and shutdown;
- Supports upgrading via remote FTP server;
- RS-485 transparent channel transmission;
- Alarm and exception information can be sent to the remote host;
- Remotely start/stop recording;
- Remotely start/stop alarm output;
- Remote PTZ control;
- Two-way audio and voice broadcasting;
- Output bandwidth limit configurable;
- Embedded WEB server;
- If DHCP is enabled, you can enable DNS DHCP or disable it and edit the Preferred DNS Server and Alternate DNS Server.

Development Scalability

- SDK for Windows and Linux system;
- Source code of application software for demo;
- Development support and training for application system.

TABLE OF CONTENTS

| | |
|--|----|
| Product Key Features | 7 |
| Chapter 1 Introduction..... | 21 |
| 1.1 Front Panel | 21 |
| 1.1.1 DS-7100HQHI-K1 | 21 |
| 1.1.2 DS-7300HQHI-K4, DS-7300HUHI-K4, iDS-7316HUHI-K4/16S and DS-7300HTHI-K4 | 21 |
| 1.1.3 DS-8100HQHI/HUHI/HTHI-K8, DS-9000HUHI/HTHI-K8 and iDS-9016HUHI-K8/16S | 25 |
| 1.1.4 Other Models | 29 |
| 1.2 IR Remote Control Operations | 30 |
| 1.2.1 Pairing (Enabling) the IR Remote to a Specific Device (optional) | 30 |
| 1.2.2 Unpair (Disable) an IR Remote from a Device..... | 31 |
| 1.2.3 Troubleshooting | 34 |
| 1.3 USB Mouse Operation..... | 35 |
| 1.4 Rear Panel | 36 |
| 1.4.1 DS-7100HQHI-K1, DS-7200HUHI-K (/P), iDS-7200HUHI-K/4S, DS-7200HTHI-K, DS-7200HQHI-K(/P), and iDS-7200HQHI-K/S..... | 36 |
| 1.4.2 DS-7300HQHI-K | 38 |
| 1.4.3 DS-7300HUHI/HTHI-K4, iDS-7316HUHI-K4/16S and DS-9000HUHI-K8 | 40 |
| 1.4.4 DS-7300HQHI/HUHI-K4, DS-8100HQHI/HUHI-K8, DS-9000HUHI-K8, and iDS-9016HUHI-K8/16S | 42 |
| 1.4.5 DS-7200HGHI-K1 | 44 |
| 1.4.6 DS-7200HGHI-K2 | 45 |
| 1.4.7 DS-8100HTHI-K8..... | 46 |
| 1.4.8 DS-9000HTHI-K8..... | 47 |
| Chapter 2 Getting Started | 49 |
| 2.1 Start up the Device..... | 49 |
| 2.2 Activate the Device | 49 |
| 2.3 Configure Unlock Pattern for Login..... | 51 |
| 2.4 Login to the Device..... | 52 |
| 2.4.1 Log in via Unlock Pattern..... | 52 |
| 2.4.2 Log in via Password | 53 |
| 2.5 Enter Wizard to Configure Quick Basic Settings..... | 53 |
| 2.6 Enter Main Menu | 57 |

| | |
|---|----|
| 2.7 System Operation..... | 58 |
| 2.7.1 Log out..... | 58 |
| 2.7.2 Shut Down the Device..... | 58 |
| 2.7.3 Reboot the Device..... | 58 |
| Chapter 3 Camera Management..... | 60 |
| 3.1 Add the IP Cameras..... | 60 |
| 3.1.1 Add the IP Camera Manually..... | 60 |
| 3.1.2 Add the Automatically Searched Online IP Cameras..... | 61 |
| 3.1.3 Connecting PoC Cameras..... | 61 |
| 3.1.4 Configure Signal Input Channel..... | 62 |
| 3.1.5 Configuring 5 MP Long Distance Transmission..... | 63 |
| 3.2 Enable the H.265 Stream Access..... | 64 |
| 3.3 Upgrade the IP Camera..... | 64 |
| Chapter 4 Camera Settings..... | 66 |
| 4.1 Configure OSD Settings..... | 66 |
| 4.2 Configure Privacy Mask..... | 67 |
| 4.3 Configure the Video Parameters..... | 68 |
| 4.4 Configure the Day/Night Switch..... | 68 |
| 4.5 Configure Other Camera Parameters..... | 69 |
| Chapter 5 Live View..... | 70 |
| 5.1 Start Live View..... | 70 |
| 5.1.1 Digital Zoom..... | 70 |
| 5.1.2 Live View Strategy..... | 71 |
| 5.2 Target Detection..... | 71 |
| 5.3 Configure Live View Settings..... | 72 |
| 5.4 Configure Live View Layout..... | 72 |
| 5.5 Configure Auto-Switch of Cameras..... | 74 |
| 5.6 Configure Channel-zero Encoding..... | 74 |
| 5.7 Using an Auxiliary Monitor..... | 75 |
| Chapter 6 PTZ Control..... | 76 |
| 6.1 PTZ Control Wizard..... | 76 |
| 6.2 Configure PTZ Parameters..... | 76 |
| 6.3 Set PTZ Presets, Patrols & Patterns..... | 77 |
| 6.3.1 Set a Preset..... | 77 |
| 6.3.2 Call a Preset..... | 78 |

| | |
|--|-----|
| 6.3.3 Set a Patrol | 79 |
| 6.3.4 Call a Patrol | 80 |
| 6.3.5 Set a Pattern | 81 |
| 6.3.6 Call a Pattern | 82 |
| 6.3.7 Set Linear Scan Limits..... | 82 |
| 6.3.8 Call Linear Scan | 83 |
| 6.3.9 One-touch Park | 83 |
| 6.4 Auxiliary Functions | 84 |
| Chapter 7 Storage | 85 |
| 7.1 Storage Device Management | 85 |
| 7.1.1 Install the HDD | 85 |
| 7.1.2 Add the Network Disk | 85 |
| 7.1.3 Configure eSATA for Data Storage | 87 |
| 7.2 Storage Mode | 88 |
| 7.2.1 Configure HDD Group | 88 |
| 7.2.2 Configure HDD Quota..... | 90 |
| 7.3 Recording Parameters | 91 |
| 7.3.1 Main Stream..... | 91 |
| 7.3.2 Sub-Stream..... | 92 |
| 7.3.3 Picture | 92 |
| 7.3.4 Configure Advanced Recording Settings | 92 |
| 7.4 Configure Recording Schedule | 93 |
| 7.5 Configure Continuous Recording | 95 |
| 7.6 Configure Motion Detection Triggered Recording | 95 |
| 7.7 Configure Event Triggered Recording..... | 96 |
| 7.8 Configure Alarm Triggered Recording | 96 |
| 7.9 Configure Picture Capture..... | 96 |
| 7.10 Configure Holiday Recording and Capture | 97 |
| 7.11 Configure Redundant Recording and Capture | 99 |
| 7.12 Configure 1080p Lite | 100 |
| 7.12.1 Enable the 1080P Lite Mode | 100 |
| 7.12.2 Disable the 1080P Lite Mode | 101 |
| Chapter 8 Disk Array..... | 102 |
| 8.1 Create Disk Array..... | 102 |
| 8.1.1 Enable RAID..... | 102 |

| | |
|--|-----|
| 8.1.2 One-Touch Creation | 103 |
| 8.1.3 Manual Creation..... | 103 |
| 8.2 Rebuild Array..... | 105 |
| 8.2.1 Configure Hot Spare Disk | 105 |
| 8.2.2 Automatically Rebuild Array..... | 105 |
| 8.2.3 Manually Rebuild Array..... | 106 |
| 8.3 Delete Array | 107 |
| 8.4 Check and Edit Firmware | 108 |
| Chapter 9 File Management | 109 |
| 9.1 Search and Export All Files | 109 |
| 9.1.1 Search Files..... | 109 |
| 9.1.2 Export Files..... | 109 |
| 9.2 Search and Export Human Files | 110 |
| 9.2.1 Search Human Files | 110 |
| 9.2.2 Export Human Files | 110 |
| 9.3 Search and Export Vehicle Files..... | 111 |
| 9.3.1 Search Vehicle Files | 111 |
| 9.3.2 Export Vehicle Files | 111 |
| 9.4 Search History Operation | 112 |
| 9.4.1 Save Search Condition..... | 112 |
| 9.4.2 Call Search History..... | 112 |
| Chapter 10 Playback | 113 |
| 10.1 Play Video Files..... | 113 |
| 10.1.1 Instant Playback | 113 |
| 10.1.2 Play Normal Video..... | 113 |
| 10.1.3 Play Smart Searched Video | 114 |
| 10.1.4 Play Custom Searched Files..... | 115 |
| 10.1.5 Play Tag Files | 116 |
| 10.1.6 Play Event Files..... | 118 |
| 10.1.7 Play by Sub-periods..... | 119 |
| 10.1.8 Play Log Files | 120 |
| 10.1.9 Play External File | 120 |
| 10.2 Playback Operations..... | 121 |
| 10.2.1 Set Play Strategy in Smart/Custom Mode..... | 121 |
| 10.2.2 Edit Video Clips..... | 122 |

| | |
|---|-----|
| 10.2.3 Switch between Main Stream and Sub-Stream | 122 |
| 10.2.4 Thumbnails View | 122 |
| 10.2.5 Fast View | 123 |
| 10.2.6 Digital Zoom | 123 |
| Chapter 11 Event and Alarm Settings | 124 |
| 11.1 Configure Arming Schedule | 124 |
| 11.2 Configure Alarm Linkage Actions | 124 |
| 11.2.1 Configure Auto-switch Full Screen Monitoring | 124 |
| 11.2.2 Configure Audio Warning | 125 |
| 11.2.3 Notify Surveillance Center | 125 |
| 11.2.4 Configure Email Linkage | 126 |
| 11.2.5 Trigger Alarm Output | 126 |
| 11.2.6 Configure PTZ Linkage | 126 |
| 11.3 Configure Motion Detection Alarm | 127 |
| 11.4 Configure Video Loss Alarm | 129 |
| 11.5 Configure Video Tampering Alarm | 130 |
| 11.6 Configure Sensor Alarms | 131 |
| 11.6.1 Configure Alarm Input | 131 |
| 11.6.2 Configure One-Key Disarming | 132 |
| 11.6.3 Configure Alarm Output | 133 |
| 11.7 Configure Exceptions Alarm | 134 |
| 11.8 Trigger or Clear Alarm Output Manually | 135 |
| Chapter 12 POS Configuration | 137 |
| 12.1 Configure POS Settings | 137 |
| 12.1.1 Configure POS Connection | 137 |
| 12.1.2 Configure POS Text Overlay | 141 |
| 12.2 Configure POS Alarm | 142 |
| Chapter 13 VCA Event Alarm | 144 |
| 13.1 Human Body Detection | 144 |
| 13.2 Face Detection | 145 |
| 13.3 Vehicle Detection | 146 |
| 13.4 Line Crossing Detection | 147 |
| 13.5 Intrusion Detection | 149 |
| 13.6 Region Entrance Detection | 150 |
| 13.7 Region Exiting Detection | 151 |

| | |
|--|------------|
| 13.8 Unattended Baggage Detection | 153 |
| 13.9 Object Removal Detection | 154 |
| 13.10 Audio Exception Detection..... | 155 |
| 13.11 Sudden Scene Change Detection | 156 |
| 13.12 Defocus Detection..... | 157 |
| 13.13 PIR Alarm..... | 158 |
| Chapter 14 Smart Analysis | 160 |
| 14.1 Face Search..... | 160 |
| 14.2 Human Body Search | 160 |
| 14.3 Vehicle Search | 161 |
| 14.4 People Counting..... | 162 |
| 14.5 Heat Map..... | 162 |
| Chapter 15 Human Body Detection | 164 |
| 15.1 Smart Analysis | 164 |
| 15.1.1 Enable Smart Analysis | 164 |
| 15.1.2 View Engine Status..... | 166 |
| 15.2 Human Body Search | 166 |
| 15.2.1 Search by Appearance..... | 166 |
| 15.2.2 Search by Picture..... | 167 |
| 15.2.3 Add Search Result as Sample Picture | 168 |
| Chapter 16 Network Settings | 169 |
| 16.1 Configure TCP/IP Settings..... | 169 |
| 16.2 Configure Hik-Connect | 170 |
| 16.3 Configure DDNS..... | 171 |
| 16.4 Configure PPPoE..... | 172 |
| 16.5 Configure NTP | 172 |
| 16.6 Configure SNMP | 173 |
| 16.7 Configure Email | 174 |
| 16.8 Configure Ports..... | 175 |
| Chapter 17 System Maintenance..... | 177 |
| 17.1 Storage Device Maintenance | 177 |
| 17.1.1 Configure Disk Clone | 177 |
| 17.1.2 S.M.A.R.T Detection | 178 |
| 17.1.3 Bad Sector Detection | 179 |
| 17.1.4 HDD Health Detection..... | 180 |

| | |
|---|-----|
| 17.2 Search & Export Log Files | 181 |
| 17.2.1 Search the Log Files | 181 |
| 17.2.2 Export the Log Files | 182 |
| 17.3 Import/Export IP Camera Configuration Files | 183 |
| 17.4 Import/Export Device Configuration Files | 184 |
| 17.5 Upgrade System | 185 |
| 17.5.1 Upgrade by Local Backup Device | 185 |
| 17.5.2 Upgrade by FTP | 185 |
| 17.5.3 Upgrade by Hik-Connect | 186 |
| 17.6 Upgrade Camera | 186 |
| 17.7 Restore Default Settings..... | 187 |
| 17.8 System Service..... | 188 |
| 17.8.1 Network Security Settings..... | 188 |
| 17.8.2 Managing ONVIF User Accounts | 189 |
| 17.8.3 Managing IP Camera Activation | 190 |
| Chapter 18 General System Settings..... | 192 |
| 18.1 Configure General Settings | 192 |
| 18.2 Configure Date & Time | 193 |
| 18.3 Configure DST Settings | 194 |
| 18.4 Configure Enhanced IP Mode | 194 |
| 18.5 Manage User Accounts | 195 |
| 18.5.1 Add a User | 195 |
| 18.5.2 Set Permission for a User | 196 |
| 18.5.3 Set Local Live View Permission for Non-Admin Users | 198 |
| 18.5.4 Edit the Admin User | 199 |
| 18.5.5 Edit the Operator/Guest User | 201 |
| 18.5.6 Delete a User | 201 |
| 18.6 Configure Password Security..... | 202 |
| 18.6.1 Export GUID File | 202 |
| 18.6.2 Configure Security Questions..... | 202 |
| 18.6.3 Configure Reserved Email | 203 |
| 18.7 Reset Password | 204 |
| 18.7.1 Reset Password by GUID | 204 |
| 18.7.2 Reset Password by Security Questions | 205 |
| 18.7.3 Reset Password by Reserved Email | 206 |

Chapter 19 Appendix208
 List of Applicable Power Adapter208

Chapter 1 Introduction

1.1 Front Panel

1.1.1 DS-7100HQHI-K1

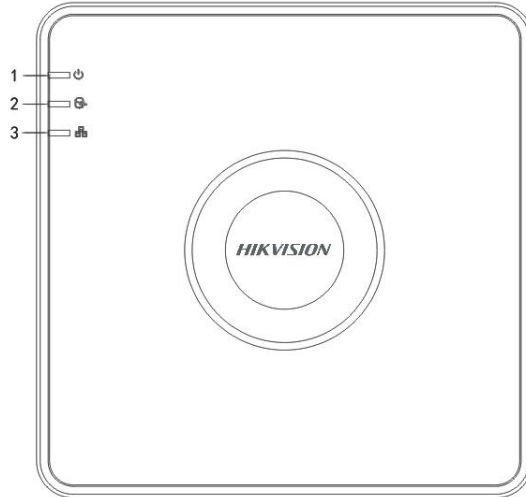

Figure 1-1 Front Panel

Table 1-1 Front Panel Description

| No. | Icon | Description |
|-----|------|--|
| 1 | | Turns red when DVR is powered up. |
| 2 | | Turns red when data is being read from or written to HDD. |
| 3 | | Flickers blue when network connection is functioning properly. |

1.1.2 DS-7300HQHI-K4, DS-7300HUHI-K4, iDS-7316HUHI-K4/16S and DS-7300HTHI-K4

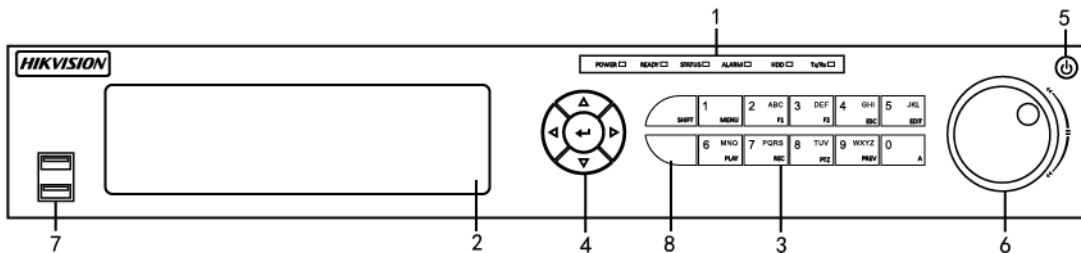

Figure 1-2 Front Panel

Table 1-2 Front Panel Description

| No. | Name | Function Description | |
|-----|-----------------------|--|---|
| 1 | POWER | Turns green when DVR is powered up. | |
| | READY | Turns green, indicating that the DVR is functioning properly. | |
| | STATUS | Turns green when device is controlled by an IR remote. | |
| | | Turns red when controlled by a keyboard and purple when IR remote and keyboard is used at the same time. | |
| | ALARM | Turns red when a sensor alarm is detected. | |
| | HDD | Flickers in red when data is being read from or written to HDD. | |
| | Tx/Rx | Flickers in green when network connection is functioning properly. | |
| 2 | DVD-R/W | Slot for DVD-R/W. | |
| 3 | Composite Keys | SHIFT | Switches between the numeric or letter input and functions of the composite keys. (Input letter or numbers when the light is out; Realize functions when the light is red.) |
| | | 1/MENU | Enters numeral "1"; Accesses the main menu interface. |
| | | 2/ABC/F1 | Enters numeral "2"; |
| | | | Enters letters "ABC"; |
| | | | The F1 button when used in a list field will select all items in the list; |
| | | | Turns on/off PTZ light in PTZ Control mode, and use it to zoom out the image; |

| No. | Name | Function Description |
|-----|-------------------|--|
| | | Switches between main and spot video output in live view or playback mode. |
| | 3/DEF/F2 | Enters numeral "3"; |
| | | Enters letters "DEF"; |
| | | Uses the F2 button is used to change the tab pages; |
| | | Zooms in the image in PTZ control mode. |
| | 4/GHI/ESC | Enters numeral "4"; |
| | | Enters letters "GHI"; |
| | | Exits and back to the previous menu. |
| | 5/JKL/EDIT | Enters numeral "5"; |
| | | Enters letters "JKL"; |
| | | Deletes characters before cursor; |
| | | Check the checkbox and select the ON/OFF switch; |
| | | Starts/stops record clipping in playback. |
| | 6/MNO/PLAY | Enters numeral "6"; |
| | | Enters letters "MNO"; |
| | | Accesses to playback interface in Playback mode. |
| | 7/PQRS/REC | Enters numeral "7"; |
| | | Enters letters "PQRS"; |
| | | Accesses to manual record interface; Manually enables/disables record. |

| No. | Name | | Function Description |
|---|--|--------------------|--|
| 4 | | 8/TUV/PTZ | Enters numeral "8"; |
| | | | Enters letters "TUV"; |
| | | | Accesses PTZ control interface. |
| | | 9/WXYZ/PREV | Enters numeral "9"; |
| | | | Enters letters "WXYZ"; |
| | | | Multi-channel display in live view. |
| | | 0/A | Enters numeral "0"; |
| | | | Shifts the input methods in the editing text field. (Upper and lowercase, alphabet, symbols or numeric input). |
| | | DIRECTION | Navigates between different fields and items in menus. |
| | Uses the Up and Down buttons to speed up and slow down the playing of video files in Playback mode. The Left and Right button will select the next and previous record files. | | |
| | Cycles through channels in Live View mode. | | |
| | Controls the movement of the PTZ camera in PTZ control mode. | | |
| Confirms selection in any of the menu modes. | | | |
| Checks the checkbox. | | | |
| Plays or pauses the playing of video files in Playback mode. | | | |
| Advances the video by a single frame in single-frame Playback mode. | | | |
| ENTER | Confirms selection in any of the menu modes. | | |
| | Checks the checkbox. | | |
| | Plays or pauses the playing of video files in Playback mode. | | |
| | Advances the video by a single frame in single-frame Playback mode. | | |

| No. | Name | Function Description |
|-----|----------------------------|--|
| | | Stops/starts auto switch in Auto-switch mode. |
| 5 | POWER | Power on/off switch. |
| 6 | JOG SHUTTLE Control | Moves the active selection up and down in a menu. |
| | | Cycles through different channels in live view mode. |
| | | Jumps 30s forward/backward in video files in the playback mode. |
| | | Controls the movement of the PTZ camera in PTZ control mode. |
| | | Moves the active selection up and down in a menu. |
| 7 | USB Interface | Universal Serial Bus (USB) ports for additional devices such as USB mouse and USB Hard Disk Drive (HDD). |
| 8 | IR Receiver | Receiver for IR remote control. |

1.1.3 DS-8100HQHI/HUHI/HTHI-K8, DS-9000HUHI/HTHI-K8 and iDS-9016HUHI-K8/16S

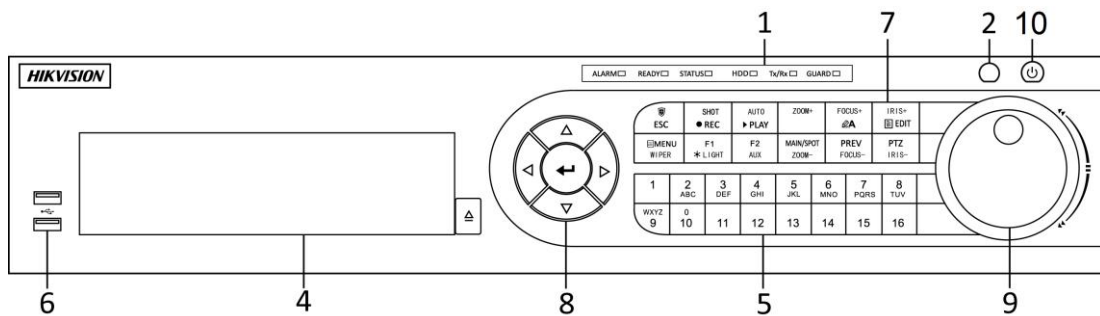

Figure 1-3 Front Panel of DS-8100HQHI/HUHI/HTHI-K8

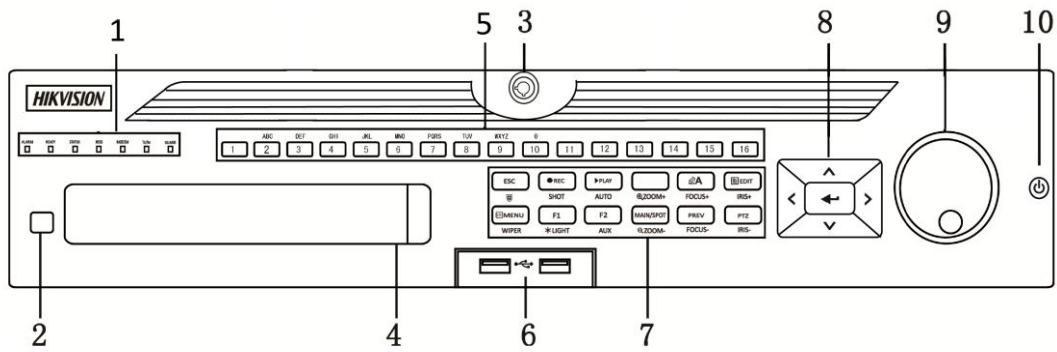

Figure 1-4 Front Panel of DS-9000HUHI/HTHI-K8 and iDS-9016HUHI-K8/16S

Table 1-3 Front Panel Description

| No. | Name | Function Description |
|--------------|---|---|
| 1 | ALARM | Turns red when a sensor alarm is detected. |
| | READY | Turns blue, indicating that the DVR is functioning properly. |
| | STATUS | Turns blue when device is controlled by an IR remote. |
| | | Turns red when controlled by a keyboard and purple when IR remote and keyboard is used at the same time. |
| | HDD | Flickers in red when data is being read from or written to HDD. |
| | MODEM | Flickers in blue when network connection is functioning properly. |
| | Tx/Rx | Turns blue when the device is in armed status; at this time, an alarm is enabled when an event is detected. |
| GUARD | Turns off when the device is unarmed. The arm/disarm status can be changed by pressing and holding on the ESC button for more than 3 seconds in live view mode. | |
| | Turns red when a sensor alarm is detected. | |
| 2 | IR Receiver | Receiver for IR remote |
| 3 | Front Panel Lock | Lock or unlock the panel by the key. |
| 4 | DVD-R/W | Slot for DVD-R/W. |
| 5 | Alphanumeric Buttons | Switches to the corresponding channel in live view or PTZ control mode. |

| | | |
|---|-----------------------|--|
| | | Inputs numbers and characters in edit mode. |
| | | Switches between different channels in playback mode. |
| | | Turns blue when the corresponding channel is recording; turns red when the channel is in network transmission status; turns pink when the channel is recording and transmitting. |
| 6 | USB Interfaces | Universal Serial Bus (USB) ports for additional devices such as USB mouse and USB Hard Disk Drive (HDD). |
| 7 | ESC | Returns to the previous menu. |
| | | Presses for arming/disarming the device in live view mode. |
| | REC/SHOT | Enters the Manual Record settings menu. |
| | | Presses this button followed by a numeric button to call a PTZ preset in PTZ control settings. |
| | | Turns audio on/off in the playback mode. |
| | PLAY/AUTO | Enters the playback mode. |
| | | Automatically scans in the PTZ control menu. |
| | ZOOM+ | Zooms in the PTZ camera in the PTZ control setting. |
| | A/FOCUS+ | Adjusts focus in the PTZ Control menu. |
| | | Switches between input methods (upper and lower case alphabet, symbols and numeric input). |
| | EDIT/IRIS+ | Edits text fields. When editing text fields, it also deletes the character in front of the cursor. |
| | | Checks the checkbox in the checkbox fields. |
| | | Adjusts the iris of the camera in PTZ control mode. |
| | | Generates video clips for backup in playback mode. |
| | | Enters/exits the folder of USB device and eSATA HDD. |

| | | |
|---|------------------------|---|
| | MAIN/SPOT/ZOOM- | Switches between main and spot output. |
| | | Zooms out the image in PTZ control mode. |
| | F1/ LIGHT | Selects all items on the list when used in a list field. |
| | | Turns on/off PTZ light (if applicable) in PTZ control mode. |
| | | Switches between play and reverse play in playback mode. |
| | F2/ AUX | Cycles through tab pages. |
| | | Switches between channels in synchronous playback mode. |
| | MENU/WIPER | Returns to the Main menu (after successful login). |
| | | Presses and holds the button for five seconds to turn off audible key beep. |
| | | Starts wiper (if applicable) in PTZ control mode. |
| | | Shows/hides the control interface in playback mode. |
| | PREV/FOCUS- | Switches between single screen and multi-screen mode. |
| | | Adjusts the focus in conjunction with the A/FOCUS+ button in PTZ control mode. |
| | PTZ/IRIS- | Enters the PTZ Control mode. |
| | | Adjusts the iris of the PTZ camera in PTZ control mode. |
| 8 | DIRECTION | Navigates between different fields and items in menus. |
| | | Uses the Up and Down buttons to speed up and slow down the playing of video files in Playback mode. |
| | | The Left and Right button will select the next and previous record files. |
| | | Cycles through channels in Live View mode. |
| | | Controls the movement of the PTZ camera in PTZ control mode. |

| | | |
|----|----------------------------|---|
| | ENTER | Confirms selection in any of the menu modes. |
| | | Checks the checkbox. |
| | | Plays or pauses the playing of video files in Playback mode. |
| | | Advances the video by a single frame in single-frame Playback mode. |
| | | Stops/starts auto switch in Auto-switch mode. |
| 9 | JOG SHUTTLE Control | Moves the active selection up and down in a menu. |
| | | Cycles through different channels in live view mode. |
| | | Jumps 30s forward/backward in video files in the playback mode. |
| | | Controls the movement of the PTZ camera in PTZ control mode. |
| 10 | POWER ON/OFF | Power on/off switch. |

1.1.4 Other Models

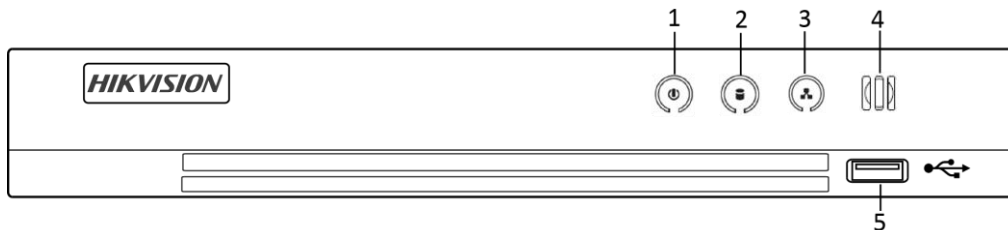





Figure 1-5 Front Panel of Other Models

Table 1-4 Front Panel Description

| No. | Icon | Description |
|-----|---|--|
| 1 |  | Turns white when DVR is powered up. |
| 2 |  | Turns red when data is being read from or written to HDD. |
| 3 |  | Flashes white when the network is well-connected. |
| 4 |  | Receiver for IR remote control. |
| 5 | USB Interface | Universal Serial Bus (USB) ports for additional devices such as USB mouse and USB Hard Disk Drive (HDD). |

1.2 IR Remote Control Operations

The device may also be controlled with the included IR remote control, shown in Figure 1-6.

Batteries (2×AAA) must be installed before operation.

The IR remote is set at the factory to control the device (using default Device ID# 255) without any additional steps. Device ID# 255 is the default universal device identification number shared by the devices. You may also pair an IR Remote to a specific device by changing the Device ID#, as follows:

1.2.1 Pairing (Enabling) the IR Remote to a Specific Device (optional)

You can pair an IR Remote to a specific device by creating a user-defined Device ID#. This feature is useful when using multiple IR Remotes and devices.

On the device:

Step 1 Go to **System > General**.

Step 2 Type a number (255 digits maximum) into **Device No.**

On the IR Remote:

Step 3 Press **DEV**.

Step 4 Use the Number buttons to enter the Device ID# that was entered into the device.

Step 5 Press **Enter** to accept the new Device ID#.

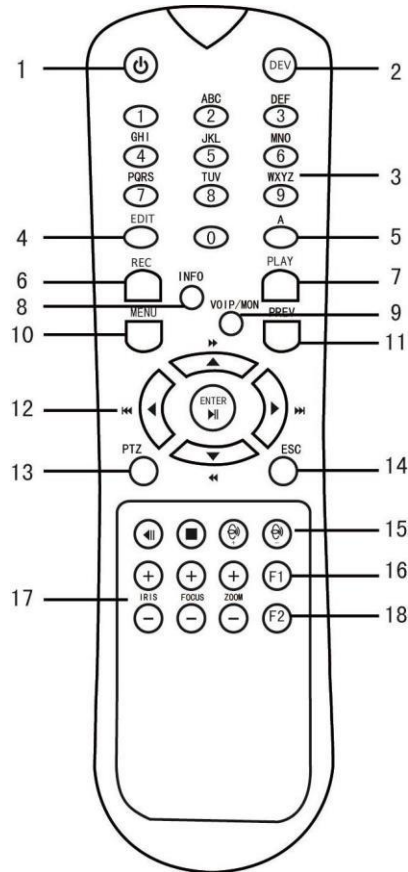

Figure 1-6 Remote Control

1.2.2 Unpair (Disable) an IR Remote from a Device

To unpair an IR Remote from a device so that the unit cannot control any device functions, proceed as follows:

Press the DEV key on the IR Remote. Any existing Device ID# will be erased from the unit’s memory and it will no longer function with the device.

 **NOTE**

(Re)-enabling the IR Remote requires pairing to a device. See “Pairing the IR Remote to a Specific device (optional),” above.

The keys on the remote control closely resemble the ones on the front panel. See the table 1.4.

Table 1-1 IR Remote Functions

| No. | Name | Function Description |
|-----|---------------------|--|
| 1 | POWER ON/OFF | <p>•To Turn Power On:</p> <p>-If User Has Not Changed the Default device ID# (255):</p> <ol style="list-style-type: none"> 1.Press Power On/Off button (1). <p>-If User Has Changed the device ID#:</p> <ol style="list-style-type: none"> 1.Press DEV button. 2.Press Number buttons to enter user-defined Device ID#. 3.Press Enter button. 4.Press Power button to start device. <p>•To Turn Device Off:</p> <p>-If User Is Logged On:</p> <ol style="list-style-type: none"> 1.Hold Power On/Off button (1) down for five seconds to display the “Yes/No” verification prompt. 2.Use Up/Down Arrow buttons (12) to highlight desired selection. 3.Press Enter button (12) to accept selection. <p>-If User Is <i>Not</i> Logged On:</p> <ol style="list-style-type: none"> 1.Hold Power On/Off button (1) down for five seconds to display the user name/password prompt. 2.Press the Enter button (12) to display the on-screen keyboard. 3.Input the user name. 4.Press the Enter button (12) to accept input and dismiss the on-screen keyboard. 5.Use the Down Arrow button (12) to move to the “Password” field. 6.Input password (use on-screen keyboard or numeric buttons (3) for numbers). 7.Press the Enter button (12) to accept input and dismiss the on-screen keyboard. 8.Press the OK button on the screen to accept input and display the Yes/No” verification prompt (use Up/Down Arrow buttons (12) to move between fields) 9.Press Enter button (12) to accept selection. <p>User name/password prompt depends on device is configuration. See “System Configuration” section.</p> |

| | | |
|----|------------------|---|
| 2 | DEV | Enable IR Remote: Press DEV button, enter device ID# with number keys, press Enter to pair unit with the device |
| | | Disable IR Remote: Press DEV button to clear Device ID#; unit will no longer be paired with the device |
| 3 | Numerals | Switch to the corresponding channel in Live View or PTZ Control mode |
| | | Input numbers in Edit mode |
| 4 | EDIT | Delete characters before cursor |
| | | Check the checkbox and select the ON/OFF switch |
| 5 | A | Adjust focus in the PTZ Control menu |
| | | Switch on-screen keyboards (upper and lower case alphabet, symbols, and numerals) |
| 6 | REC | Enter Manual Record setting menu |
| | | Call a PTZ preset by using the numeric buttons in PTZ control settings |
| | | Turn audio on/off in Playback mode |
| 7 | PLAY | Go to Playback mode |
| | | Auto scan in the PTZ Control menu |
| 8 | INFO | Reserved |
| 9 | VOIP | Switches between main and spot output Zooms out the image in PTZ control mode |
| 10 | MENU | Return to Main menu (after successful login) |
| | | N/A |
| | | Show/hide full screen in Playback mode |
| 12 | DIRECTION | Navigate between fields and menu items |
| | | Use Up/Down buttons to speed up/slow down recorded video, and Left/Right buttons to advance/rewind 30 secs in Playback mode |
| | | Cycle through channels in Live View mode |
| | | Control PTZ camera movement in PTZ control mode |
| | ENTER | Confirm selection in any menu mode |

| | | |
|----|--------------------|--|
| | | Checks checkbox |
| | | Play or pause video in Playback mode |
| | | Advance video a single frame in single-frame Playback mode |
| | | Stop/start auto switch in auto-switch mode |
| 13 | PTZ | Enter PTZ Control mode |
| 14 | ESC | Go back to previous screen |
| | | N/A |
| 15 | RESERVED | Reserved |
| 16 | F1 | Select all items on a list |
| | | N/A |
| | | Switch between play and reverse play in Playback mode |
| 17 | PTZ Control | Adjust PTZ camera iris, focus, and zoom |
| 18 | F2 | Cycle through tab pages |
| | | Switch between channels in Synchronous Playback mode |

1.2.3 Troubleshooting



Make sure you have installed batteries properly in the remote control. And you have to aim the remote control at the IR receiver in the front panel.

If there is no response after you press any button on the remote, follow the procedure below to troubleshoot.

Step 1 Go to **System > General** by operating the front control panel or the mouse.

Step 2 Check and remember device ID#. The default ID# is 255. This ID# is valid for all the IR remote controls.

Step 3 Press **DEV** on the remote control.

Step 4 Enter the device ID# you set in step 2.

Step 5 Press **ENTER** on the remote.

If the Status indicator on the front panel turns blue, the remote control is operating properly. If the Status indicator does not turn blue and there is still no response from the remote, please check the following:

- Batteries are installed correctly and the polarities of the batteries are not reversed.

- Batteries are fresh and not out of charge.
- IR receiver is not obstructed.
- No fluorescent lamp is used nearby

If the remote still can't function properly, please change a remote and try again, or contact the device provider.

1.3 USB Mouse Operation

A regular 3-button (Left/Right/Scroll-wheel) USB mouse can also be used with this device. To use a USB mouse:

Step 1 Plug USB mouse into one of the USB interfaces on the front panel of the device.

Step 2 The mouse should automatically be detected. If in a rare case that the mouse is not detected, the possible reason may be that the two devices are not compatible, please refer to the recommended the device list from your provider.

The operation of the mouse:

Table 1-2 Description of the Mouse Control

| Name | Action | Description |
|--------------|----------------|---|
| Left-Click | Single-Click | <ul style="list-style-type: none"> ● Live view: Select channel and show the quick set menu. ● Menu: Select and enter. |
| | Double-Click | Live view: Switch between single-screen and multi-screen. |
| | Click and Drag | <ul style="list-style-type: none"> ● PTZ control: pan, tilt and zoom. ● Video tampering, privacy mask and motion detection: Select target area. ● Digital zoom-in: Drag and select target area. ● Live view: Drag channel/time bar. |
| Right-Click | Single-Click | <ul style="list-style-type: none"> ● Live view: Show menu. ● Menu: Exit current menu to upper level menu. |
| Scroll-Wheel | Scrolling up | <ul style="list-style-type: none"> ● Live view: Previous screen. ● Menu: Previous item. |
| | Scrolling down | <ul style="list-style-type: none"> ● Live view: Next screen. ● Menu: Next item. |

1.4 Rear Panel



The rear panel varies according to different models. Please refer to the actual product. The following figures are for reference only.

1.4.1 DS-7100HQHI-K1, DS-7200HUHI-K (/P), iDS-7200HUHI-K/4S, DS-7200HTHI-K, DS-7200HQHI-K(/P), and iDS-7200HQHI-K/S

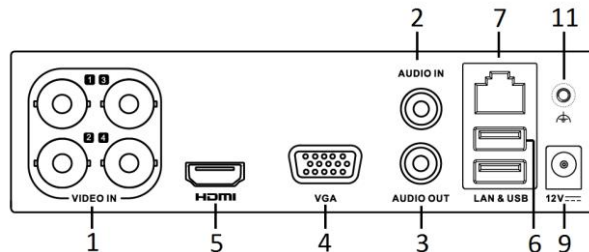

Figure 1-7 Rear Panel of DS-7100HQHI-K1

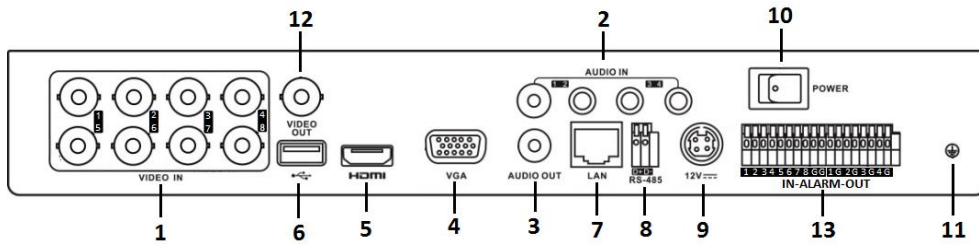

Figure 1-8 Rear Panel of DS-7200HUHI-K and iDS-7200HUHI-K/4S

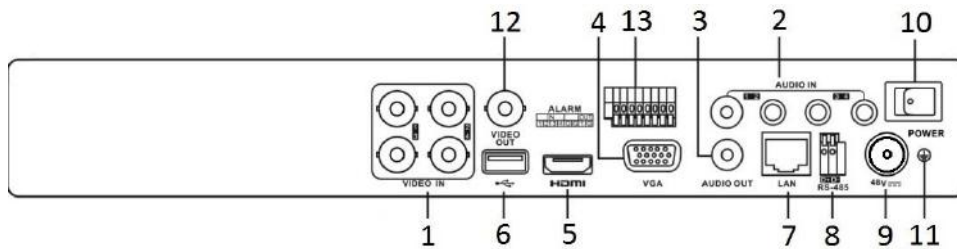

Figure 1-9 Rear Panel of DS-7200HUHI-K/P

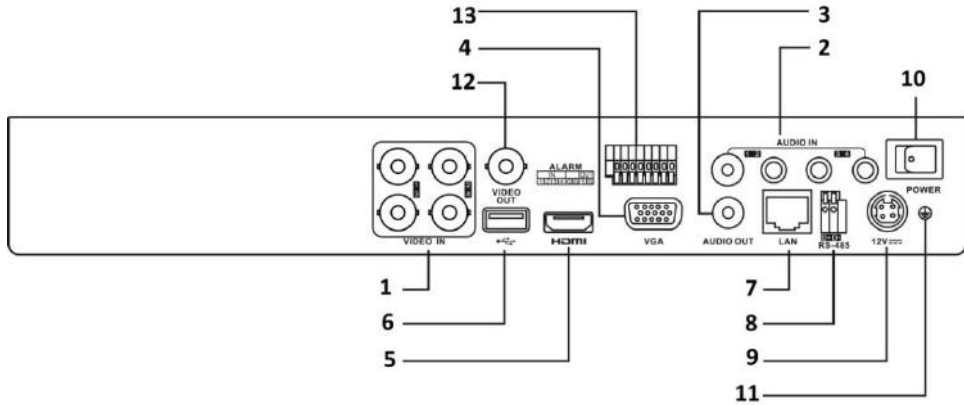

Figure 1-10 Rear Panel of DS-7200HTHI-K1

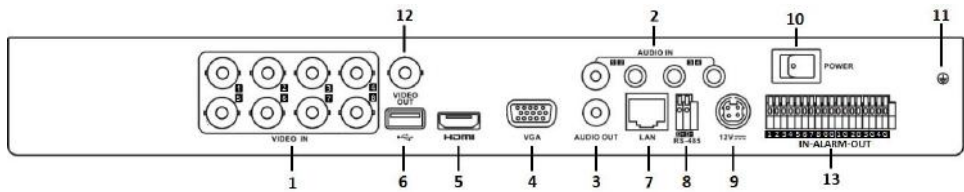

Figure 1-11 Rear Panel of DS-7200HTHI-K2

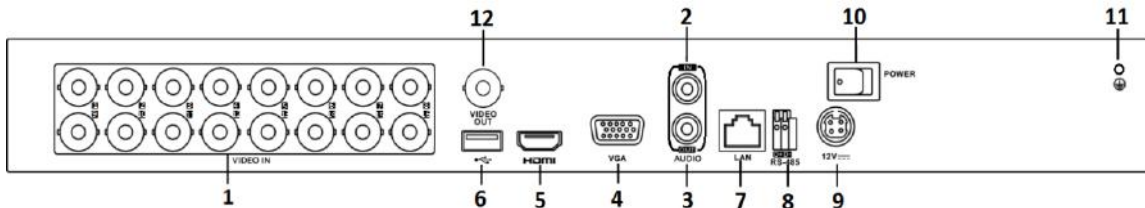

Figure 1-12 Rear Panel of DS-7200HQHI-K (with 16 Video Inputs) and iDS-7200HQHI-K/S

NOTE

Rear panels of these series DVR with 4 or 8 video inputs are similar to the figure above.

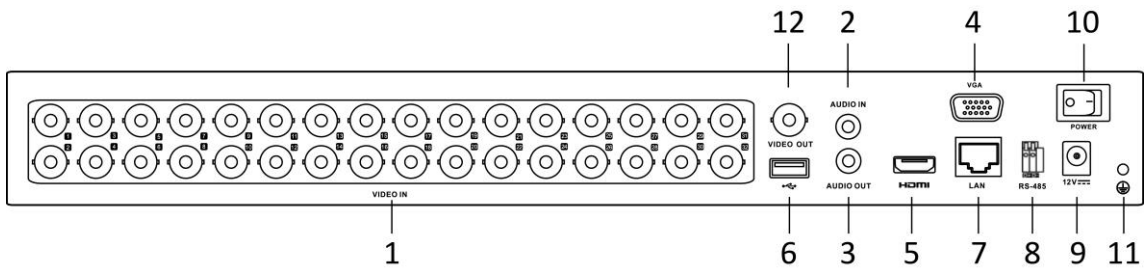

Figure 1-13 Rear Panel of DS-7200HQHI-K (with 32 Video Inputs)

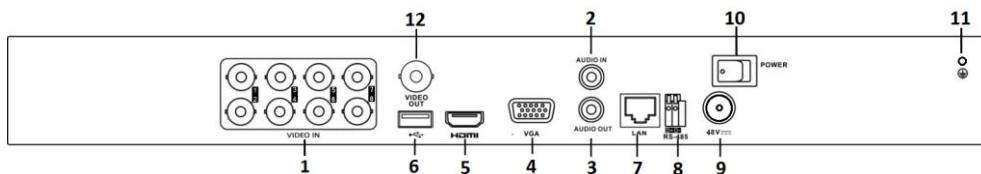

Figure 1-14 Rear Panel of DS-7200HQHI-K/P

Table 1-3 Rear Panel Description

| No. | Item | Description |
|-----|--------------------------|---|
| 1 | VIDEO IN | BNC interface for Turbo HD and analog video input. |
| 2 | AUDIO IN | RCA connector |
| 3 | AUDIO OUT | RCA connector. |
| 4 | VGA | DB15 connector for VGA output. Display local video output and menu. |
| 5 | HDMI | HDMI video output connector. |
| 6 | USB Interface | Universal Serial Bus (USB) port for additional devices. |
| 7 | Network Interface | Connector for network |
| 8 | RS-485 Interface | Connector for RS-485 devices. |
| 9 | Power Supply | 48 VDC or 12 VDC. |
| 10 | Power Switch | Switch for turning on/off the device. |
| 11 | GND | Ground |
| 12 | VIDEO OUT | BNC connector for video output. |
| 13 | Alarm In/Out | Connector for alarm input and output. |

1.4.2 DS-7300HQHI-K

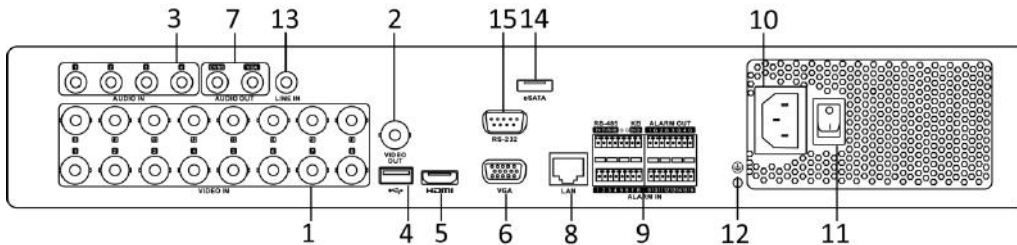

Figure 1-15 Rear Panel of DS-7300HQHI-K (with 16 Video Inputs)

Table 1-4 Rear Panel Description

| No. | Item | Description |
|-----|-----------------------------------|---|
| 1 | VIDEO IN | BNC interface for Turbo HD and analog video input. |
| 2 | VIDEO OUT | BNC connector for video output. |
| 3 | AUDIO IN | RCA connector |
| 4 | USB Port | Universal Serial Bus (USB) port for additional devices. |
| 5 | HDMI | HDMI video output connector. |
| 6 | VGA | DB15 connector for VGA output. Display local video output and menu. |
| 7 | AUDIO OUT | RCA connector. |
| 8 | Network Interface | Connector for network |
| 9 | RS-485 and Alarm Interface | Connector for RS-485 devices. T+ and T- pins connect to R+ and R- pins of PTZ receiver respectively. |
| | | D+, D- pin connects to Ta, Tb pin of controller. For cascading devices, the first DVR's D+, D- pin should be connected with the D+, D- pin of the next DVR. |
| | | Connector for alarm input. |
| | | Connector for alarm output. |
| 10 | Power Supply | 100 to 240 VAC power supply. |
| 11 | Power Switch | Switch for turning on/off the device. |
| 12 | GND | Ground |
| 13 | LINE IN | BNC connector for audio input. |
| 14 | eSATA | Connects external SATA HDD, CD/DVD-RW. |

| No. | Item | Description |
|-----|-------------------------|-------------------------------|
| 15 | RS-232 Interface | Connector for RS-232 devices. |

1.4.3 DS-7300HUHI/HTHI-K4, iDS-7316HUHI-K4/16S and DS-9000HUHI-K8

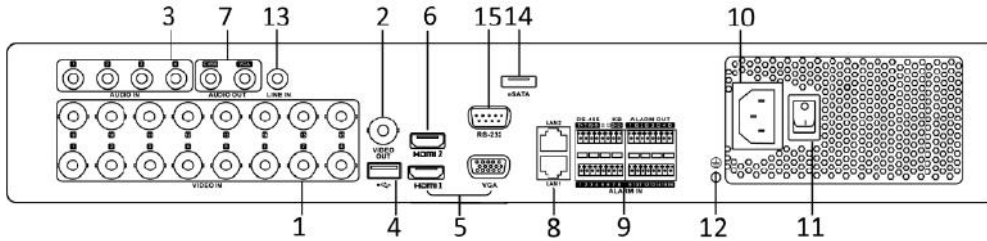

Figure 1-16 Rear Panel of DS-7300HUHI/HTHI-K4 and iDS-7316HUHI-K4/16S

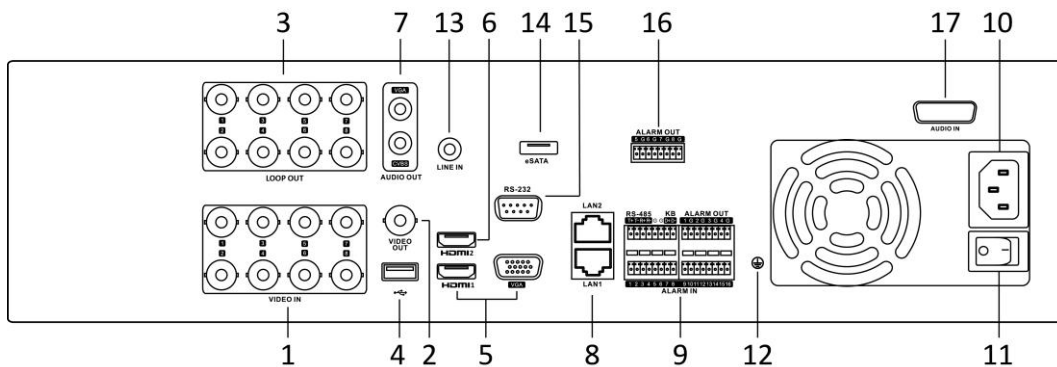

Figure 1-17 Rear Panel of DS-9000HUHI-K8 (with 8 Video Inputs)

Table 1-5 Rear Panel Description

| No. | Item | Description |
|-----|--|---|
| 1 | VIDEO IN | BNC interface for Turbo HD and analog video input. |
| 2 | VIDEO OUT | BNC connector for video output. |
| 3 | AUDIO IN/ LOOP OUT (for DS-9000HUHI-K8) | RCA connector |
| 4 | USB Port | Universal Serial Bus (USB) port for additional devices. |
| 5 | HDMI1/VGA | Simultaneous HDMI1/VGA output. Display local video output and menu. |
| 6 | HDMI2 | HDMI2 video output connector. |

| No. | Item | Description |
|-----|--------------------------------------|---|
| 7 | AUDIO OUT | RCA connector. |
| 8 | Network Interface | Connector for network |
| 9 | RS-485 and Alarm Interface | Connector for RS-485 devices. T+ and T- pins connect to R+ and R- pins of PTZ receiver respectively. |
| | | D+, D- pin connects to Ta, Tb pin of controller. For cascading devices, the first DVR's D+, D- pin should be connected with the D+, D- pin of the next DVR. |
| | | Connector for alarm input. |
| | | Connector for alarm output. |
| 10 | Power Supply | 100 to 240 VAC power supply. |
| 11 | Power Switch | Switch for turning on/off the device. |
| 12 | GND | Ground |
| 13 | LINE IN | BNC connector for audio input. |
| 14 | eSATA | Connects external SATA HDD, CD/DVD-RW. |
| 15 | RS-232 Interface | Connector for RS-232 devices. |
| 16 | ALARM OUT | Connector for alarm output. |
| 17 | AUDIO IN (for DS-9000HUHI-K8) | RCA connector |

1.4.4 DS-7300HQHI/HUHI-K4, DS-8100HQHI/HUHI-K8, DS-9000HUHI-K8, and iDS-9016HUHI-K8/16S

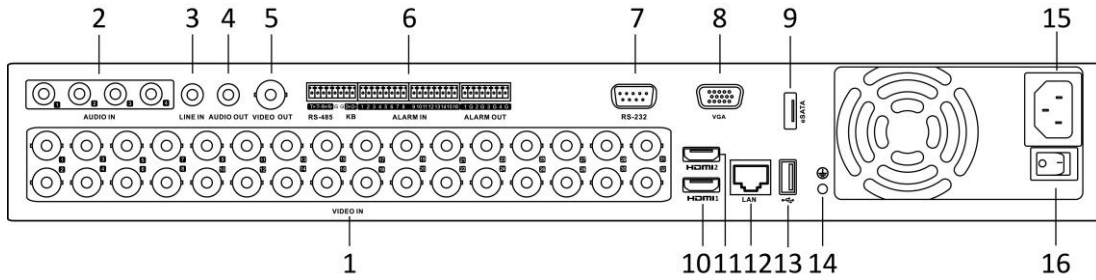

Figure 1-18 Rear Panel of DS-7300HQHI-K4 (with 32-ch Video Inputs)

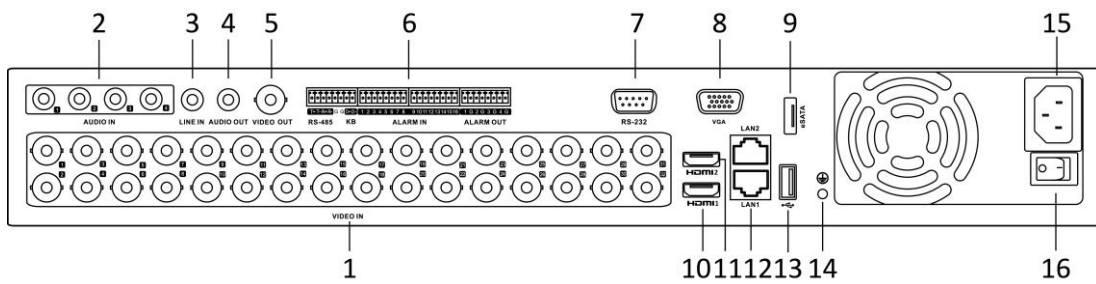

Figure 1-19 Rear Panel of DS-7300HUHI-K4 (with 32-ch Video Inputs)

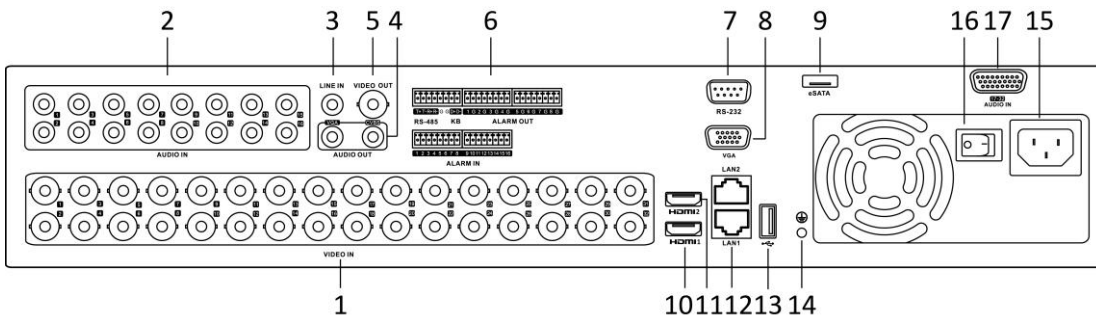

Figure 1-20 Rear Panel of DS-8100HQHI/HUHI-K8 (with 32-ch Video Inputs)

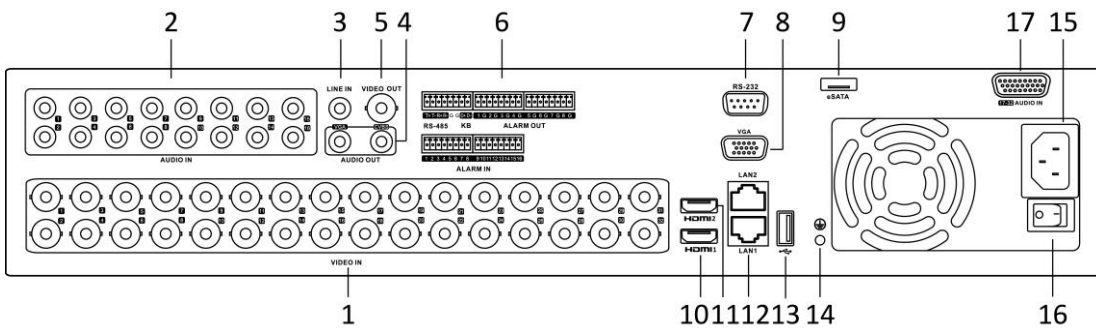

Figure 1-21 Rear Panel of DS-9000HUHI-K8 (with 32-ch Video Inputs)

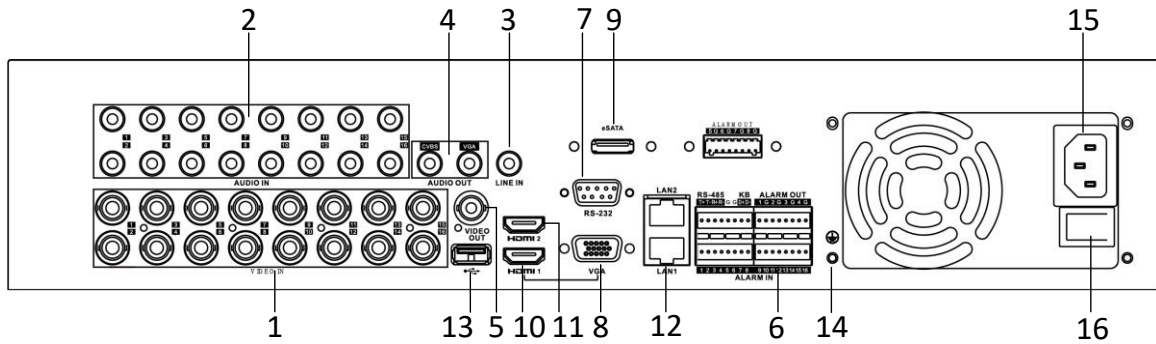

Figure 1-22 Rear Panel of iDS-9016HUHI-K8/16S

Table 1-6 Rear Panel Description

| No. | Item | Description |
|-----|-----------------------------------|---|
| 1 | VIDEO IN | BNC interface for Turbo HD and analog video input. |
| 2 | AUDIO IN | RCA connector. |
| 3 | LINE IN | BNC connector for audio input. |
| 4 | AUDIO OUT | RCA connector. |
| 5 | VIDEO OUT | BNC connector for video output. |
| 6 | RS-485 and Alarm Interface | <p>Connector for RS-485 devices. T+ and T- pins connect to R+ and R- pins of PTZ receiver respectively.</p> <p>D+, D- pin connects to Ta, Tb pin of controller. For cascading devices, the first DVR's D+, D- pin should be connected with the D+, D- pin of the next DVR.</p> <p>Connector for alarm input.</p> <p>Connector for alarm output.</p> |
| 7 | RS-232 Interface | Connector for RS-232 devices. |
| 8 | VGA Interface | VGA video output connector. Display local video output and menu. |
| 9 | eSATA | Connects external SATA HDD, CD/DVD-RW. |
| 10 | HDMI1 Interface | HDMI1 video output connector. Display local video output and menu. |

| No. | Item | Description |
|-----|--------------------------|---|
| 11 | HDMI2 Interface | HDMI2 video output connector. |
| 12 | Network Interface | Connector for network. |
| 13 | USB Interface | Universal Serial Bus (USB) port for additional devices. |
| 14 | GND | Ground |
| 15 | Power Supply | 100 to 240 VAC power supply. |
| 16 | Power Switch | Switch for turning on/off the device. |
| 17 | AUDIO IN | DB26 female head |

1.4.5 DS-7200HGHI-K1

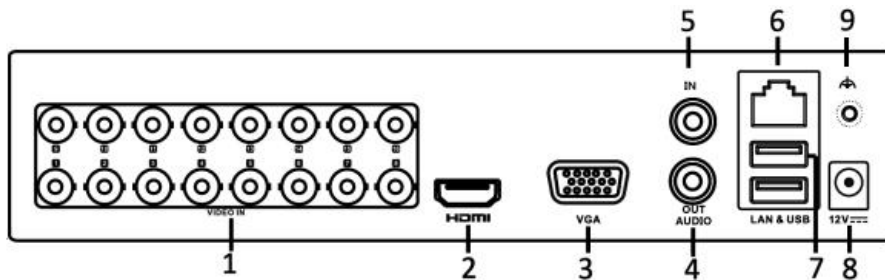

Figure 1-23 Rear Panel of DS-7200HGHI-K1

Table 1-7 Rear Panel Description

| No. | Item | Description |
|-----|--------------------------|--|
| 1 | VIDEO IN | BNC interface for Turbo HD and analog video input. |
| 2 | HDMI Interface | HDMI video output connector. |
| 3 | VGA Interface | VGA video output connector. Display local video output and menu. |
| 4 | AUDIO OUT | RCA connector. |
| 5 | AUDIO IN | RCA connector. |
| 6 | Network Interface | Connector for network. |

| No. | Item | Description |
|-----|----------------------|---|
| 7 | USB Interface | Universal Serial Bus (USB) port for additional devices. |
| 8 | Power Supply | 12 VDC power supply. |
| 9 | GND | Ground |

1.4.6 DS-7200HGHI-K2

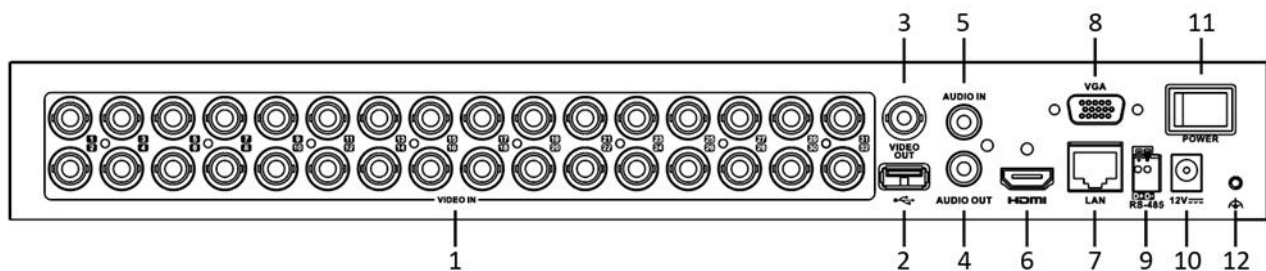

Figure 1-24 Rear Panel of DS-7200HGHI-K2

Table 1-8 Rear Panel Description

| No. | Item | Description |
|-----|--------------------------|---|
| 1 | VIDEO IN | BNC interface for Turbo HD and analog video input. |
| 2 | USB Interface | Universal Serial Bus (USB) port for additional devices. |
| 3 | VIDEO OUT | BNC connector for video output. |
| 4 | AUDIO OUT | RCA connector. |
| 5 | AUDIO IN | RCA connector. |
| 6 | HDMI Interface | HDMI video output connector. |
| 7 | Network Interface | Connector for network. |
| 8 | VGA Interface | VGA video output connector. Display local video output and menu. |
| 9 | RS-485 Interface | D+, D- pin connects to Ta, Tb pin of controller. For cascading devices, the first DVR's D+, D- pin should be connected with the D+, D- pin of the next DVR. |

| No. | Item | Description |
|-----|---------------------|---------------------------------------|
| 10 | Power Supply | 12 VDC power supply. |
| 11 | Power Switch | Switch for turning on/off the device. |
| 12 | GND | Ground |

1.4.7 DS-8100HTHI-K8

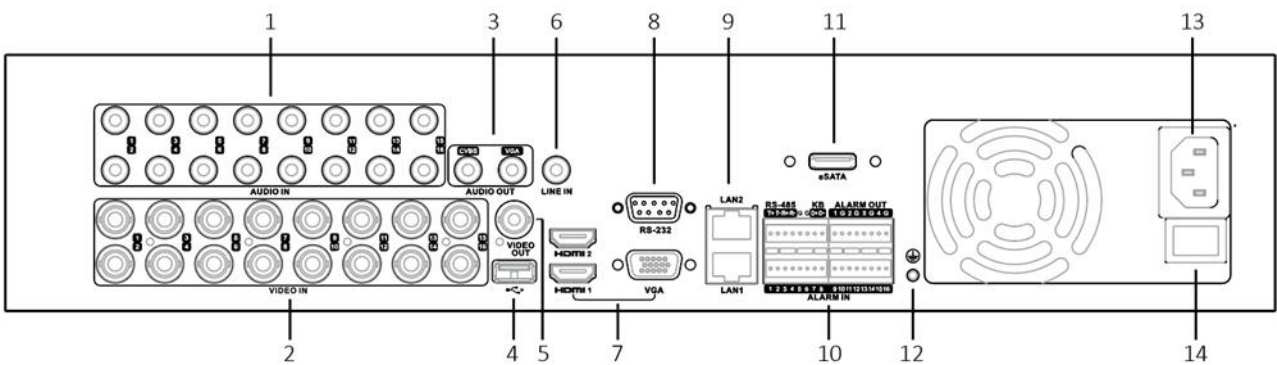

Figure 1-25 Rear Panel of DS-8100HTHI-K8

Table 1-9 Rear Panel Description

| No. | Item | Description |
|-----|---------------------------------------|---|
| 1 | AUDIO IN | RCA connector. |
| 2 | VIDEO IN | BNC interface for Turbo HD and analog video input. |
| 3 | AUDIO OUT | RCA connector. |
| 4 | USB Interface | Universal Serial Bus (USB) port for additional devices. |
| 5 | VIDEO OUT | BNC connector for video output. |
| 6 | LINE IN | BNC connector for audio input. |
| 7 | HDMI1, HDMI2 and VGA Interface | HDMI1, HDMI2 and VGA video output connector. |
| 8 | RS-232 Interface | Connector for RS-232 devices. |

| No. | Item | Description |
|-----|-----------------------------------|---|
| 9 | Network Interface | Connector for network. |
| 10 | RS-485 and Alarm Interface | Connector for RS-485 devices. T+ and T- pins connect to R+ and R- pins of PTZ receiver respectively. |
| | | D+, D- pin connects to Ta, Tb pin of controller. For cascading devices, the first DVR's D+, D- pin should be connected with the D+, D- pin of the next DVR. |
| | | Connector for alarm input. |
| | | Connector for alarm output. |
| 11 | eSATA | Connects external SATA HDD, CD/DVD-RW. |
| 12 | GND | Ground |
| 13 | Power Supply | 100 to 240 VAC power supply. |
| 14 | Power Switch | Switch for turning on/off the device. |

1.4.8 DS-9000HTHI-K8

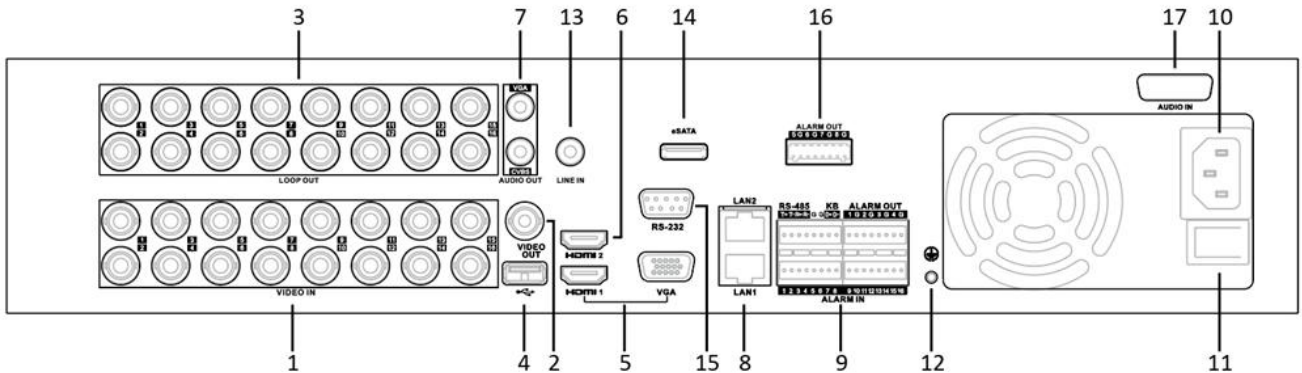

Figure 1-26 Rear Panel of DS-9000HTHI-K8

Table 1-10 Rear Panel Description

| No. | Item | Description |
|-----|-----------------|--|
| 1 | VIDEO IN | BNC interface for Turbo HD and analog video input. |

| No. | Item | Description |
|-----|-----------------------------------|---|
| 2 | VIDEO OUT | BNC connector for video output. |
| 3 | LOOP OUT | RCA connector |
| 4 | USB Interface | Universal Serial Bus (USB) port for additional devices. |
| 5 | HDMI1 and VGA Interface | HDMI1 and VGA video output interface. |
| 6 | HDMI2 Interface | HDMI2 video output interface. |
| 7 | AUDIO OUT | RCA connector. |
| 8 | Network Interface | Connector for network. |
| 9 | RS-485 and Alarm Interface | Connector for RS-485 devices. T+ and T- pins connect to R+ and R- pins of PTZ receiver respectively. |
| | | D+, D- pin connects to Ta, Tb pin of controller. For cascading devices, the first DVR's D+, D- pin should be connected with the D+, D- pin of the next DVR. |
| | | Connector for alarm input. |
| | | Connector for alarm output. |
| 10 | Power Supply | 100 to 240 VAC power supply. |
| 11 | Power Switch | Switch for turning on/off the device. |
| 12 | GND | Ground |
| 13 | LINE IN | BNC connector for audio input. |
| 14 | eSATA | Connects external SATA HDD, CD/DVD-RW. |
| 15 | RS-232 Interface | Connector for RS-232 devices. |
| 16 | ALARM OUT | Connector for alarm output (optional). |
| 17 | AUDIO IN | Audio in interface. |

Chapter 2 Getting Started

2.1 Start up the Device

Purpose:

Proper startup and shutdown procedures are crucial to expanding the life of the device.

Before you start:

Check that the voltage of the extra power supply is the same with the device's requirement, and the ground connection is working properly.

Step 1 Connect the device power supply interface and electrical socket with delivered power cable. It is HIGHLY recommended that an Uninterruptible Power Supply (UPS) be used in conjunction with the device. The Power button on the front panel should be red, indicating the device is receiving the power.

2.2 Activate the Device

Purpose:

For the first-time access, you need to activate the device by setting an admin password. No operation is allowed before activation. You can also activate the device via Web Browser, SADP, or Client Software.

Step 1 Enter the admin password twice.

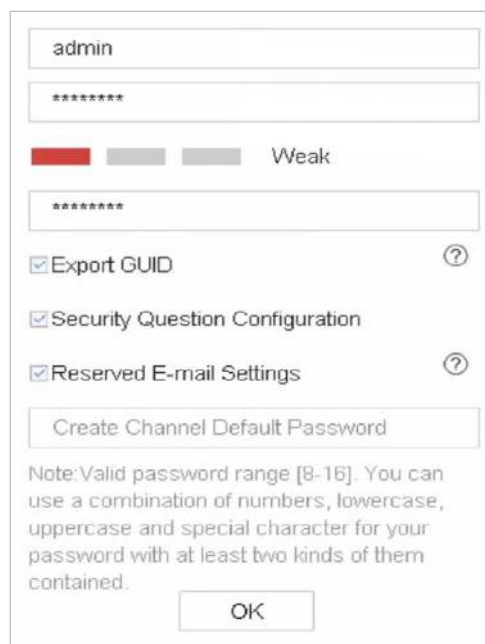

The screenshot displays a web-based configuration window for setting an admin password. At the top, there are two text input fields: the first contains the text 'admin' and the second contains seven asterisks. Below these fields is a password strength indicator consisting of three colored bars (red, grey, grey) and the label 'Weak'. A third text input field, also containing seven asterisks, is positioned below the strength indicator. Underneath are three checked checkboxes: 'Export GUID' (with a help icon), 'Security Question Configuration', and 'Reserved E-mail Settings' (with a help icon). A 'Create Channel Default Password' button is located below the checkboxes. At the bottom of the window, there is a note: 'Note: Valid password range [8-16]. You can use a combination of numbers, lowercase, uppercase and special character for your password with at least two kinds of them contained.' and an 'OK' button.

Figure 2-1 Set Admin Password

 **WARNING**

We highly recommend you create a strong password of your own choosing (Using a minimum of 8 characters, including at least three of the following categories: upper case letters, lower case letters, numbers, and special characters.) in order to increase the security of your product. And we recommend you reset your password regularly, especially in the high security system, resetting the password monthly or weekly can better protect your product.

Step 2 Enter the password to activate the IP camera(s) connected to the device.

Step 3 Optionally, check **Export GUID**, **Security Question Configuration**, or **Reserved E-mail Settings** for password resetting in the future.

Step 4 Click **OK**.

What to do next:

- When you have enabled **Export GUID**, continue to export the GUID file to the USB flash drive for the future password resetting.
- When you have enabled **Security Question Configuration**, continue to set the security questions for the future password resetting.

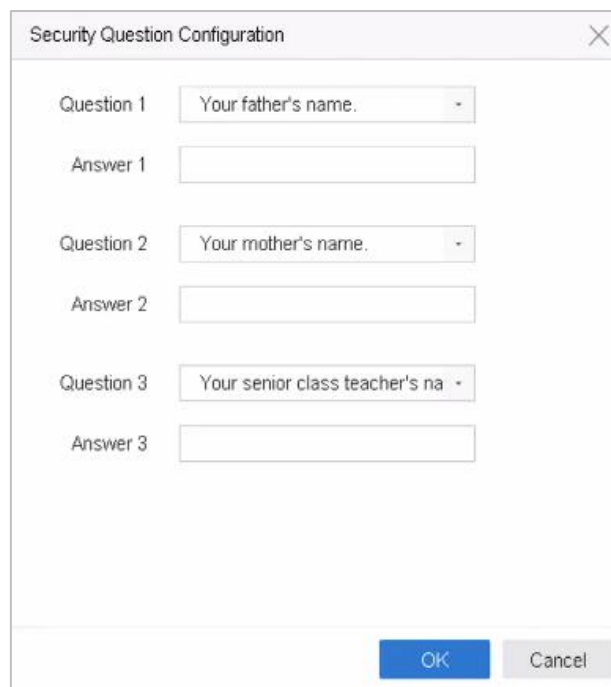

| Question | Answer |
|---|----------|
| Question 1: Your father's name. | Answer 1 |
| Question 2: Your mother's name. | Answer 2 |
| Question 3: Your senior class teacher's name. | Answer 3 |

Figure 2-2 Set Security Questions

- When you have enabled **Reserved E-mail Settings**, continue to set the reserved email for the future password resetting.

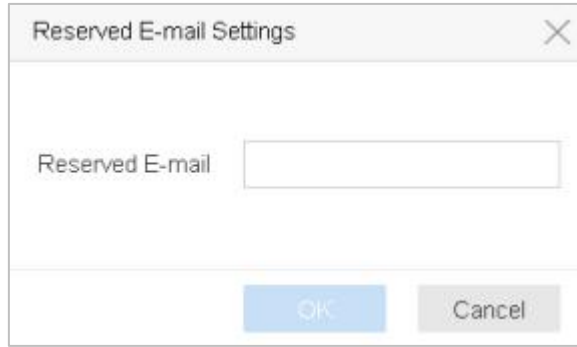

Figure 2-3 Set the Reserved Email

 **NOTE**

- After the device is activated, you should properly keep the password.
- You can duplicate the password to the IP cameras that are connected with default protocol.

2.3 Configure Unlock Pattern for Login

Purpose:

For the admin user, you can configure the unlock pattern for device login.

Step 1 After the device is activated, you can enter the following interface to configure the device unlock pattern.

Step 2 Use the mouse to draw a pattern among the 9 dots on the screen. Release the mouse when the pattern is done.

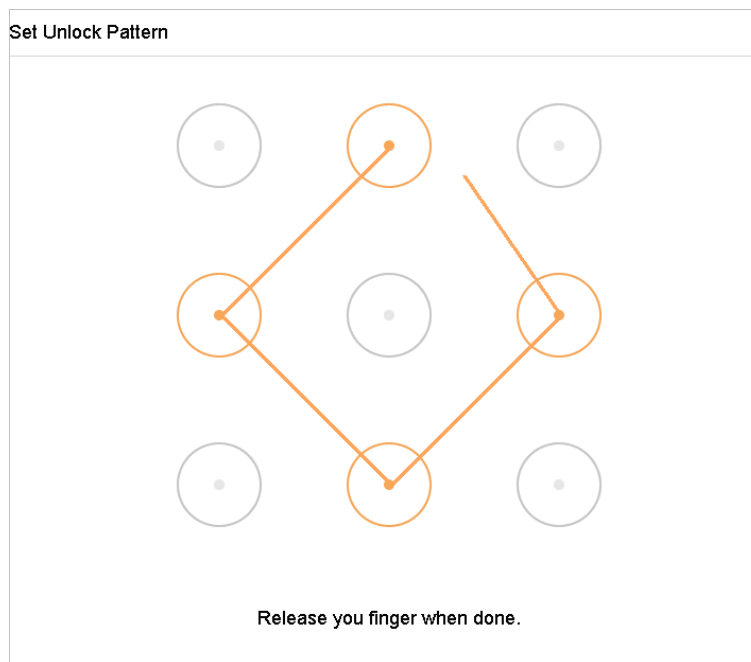

Figure 2-4 Draw the Pattern

 NOTE

- Connect at least 4 dots to draw the pattern.
- Each dot can be connected for once only.

Step 3 Draw the same pattern again to confirm it. When the two patterns match, the pattern is configured successfully.

2.4 Login to the Device

2.4.1 Log in via Unlock Pattern

 NOTE

- Only the *admin* user has the permission to unlock the device.
- Please configure the pattern first before unlocking. Please refer to 2.2 Activate the Device.

Step 1 Right click the mouse on the screen and select the menu to enter the interface.

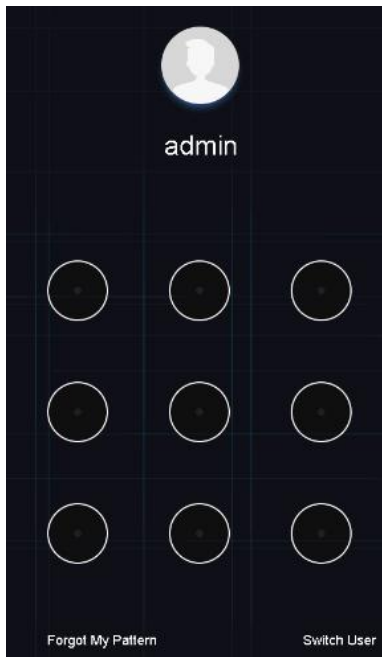

Figure 2-5 Draw the Unlock Pattern

Step 2 Draw the pre-defined pattern to unlock to enter the menu operation.

 NOTE

- If you have forgotten your pattern, you can select the **Forgot My Pattern** or **Switch User** option to enter the normal login dialog box.
- When the pattern you draw is different from the pattern you have configured, you should try again.
- If you have drawn the wrong pattern for more than 5 times, the system will switch to the normal login mode automatically.

2.4.2 Log in via Password

Purpose:

If device has logged out, you must login the device before operating the menu and other functions.

Step 1 Select the **User Name** in the dropdown list.

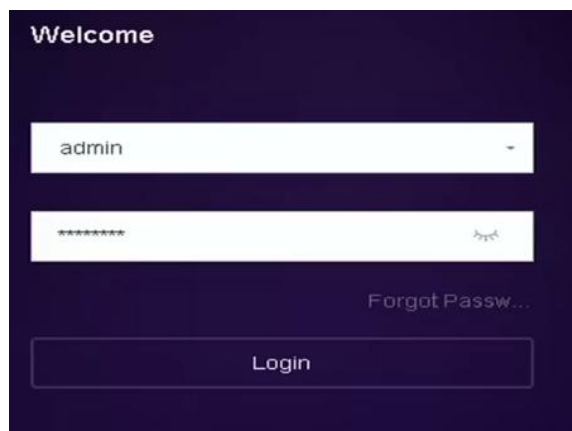

Figure 2-6 Login Interface

Step 2 Input password.

Step 3 Click **OK** to log in.

NOTE

- When you forget the password of the admin, you can click **Forgot Password** to reset the password.
- In the Login dialog box, if you enter the wrong password 7 times, the current user account will be locked for 60 seconds.

2.5 Enter Wizard to Configure Quick Basic Settings

Purpose:

By default, the Setup Wizard starts once the device has loaded.

The Setup Wizard can walk you through some important settings of the device. If you don't want to use the Setup Wizard at that moment, click the **Exit** button.

Step 1 Configure the date and time on the Date and Time Setup interface.

The screenshot shows the 'Date and Time Setup' window. It contains the following elements:

- Time Zone:** A dropdown menu with '(GMT+08:00) Beijing, Urumqi' selected.
- Date Format:** A dropdown menu with 'DD-MM-YYYY' selected.
- System Date:** A text input field containing '10-10-2017' and a calendar icon to its right.
- System Time:** A text input field containing '16:12:33' and a clock icon to its right.
- Enable Wizard:** A checked checkbox.
- Navigation:** Three buttons labeled 'Previous', 'Next', and 'Exit' at the bottom right.

Figure 2-7 Date and Time Settings

Step 2 After the time settings, click **Next** to enter the Network Setup Wizard window, as shown in the following figure.

The screenshot shows the 'Network Setup' window. It contains the following elements:

- Working Mode:** A dropdown menu with 'Net Fault-Tolerance' selected.
- Select NIC:** A dropdown menu with 'bond0' selected.
- NIC Type:** A dropdown menu with '10M/100M/1000M Self-adapt' selected.
- Enable Obtain DNS Serv...:** An unchecked checkbox.
- Preferred DNS Server:** An empty text input field.
- Alternate DNS Server:** An empty text input field.
- Main NIC:** A dropdown menu with 'LAN1' selected.
- Enable DHCP:** A checked checkbox.
- IPv4 Address:** A text input field containing '10 . 15 . 1 . 19'.
- IPv4 Subnet Mask:** A text input field containing '255 . 255 . 255 . 0'.
- IPv4 Default Gateway:** A text input field containing '10 . 15 . 1 . 254'.
- Navigation:** Three buttons labeled 'Previous', 'Next', and 'Exit' at the bottom right.

Figure 2-8 Network Settings

Step 3 Click **Next** after you configured the network parameters, which takes you to the **HDD Management** window.

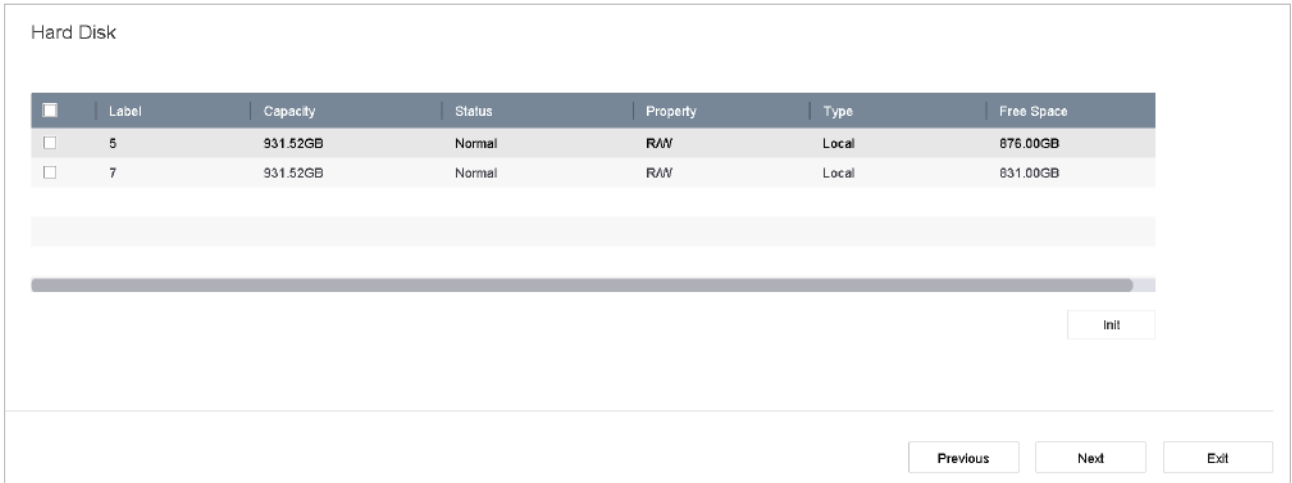

Figure 2-9 HDD Management

Step 4 To initialize the HDD, click the **Init** button. Initialization removes all the data saved in the HDD.

Step 5 Click **Next**. You enter the **Camera Setup** interface to add the IP cameras.

- 1) Click **Search** to search the online IP Camera. Before adding the camera, make sure the IP camera to be added is in active status.
- 2) Click the **Add** to add the camera.

 **NOTE**

If the camera is in inactive status, you can select the camera from the list and click **Activate** to activate the cameras.

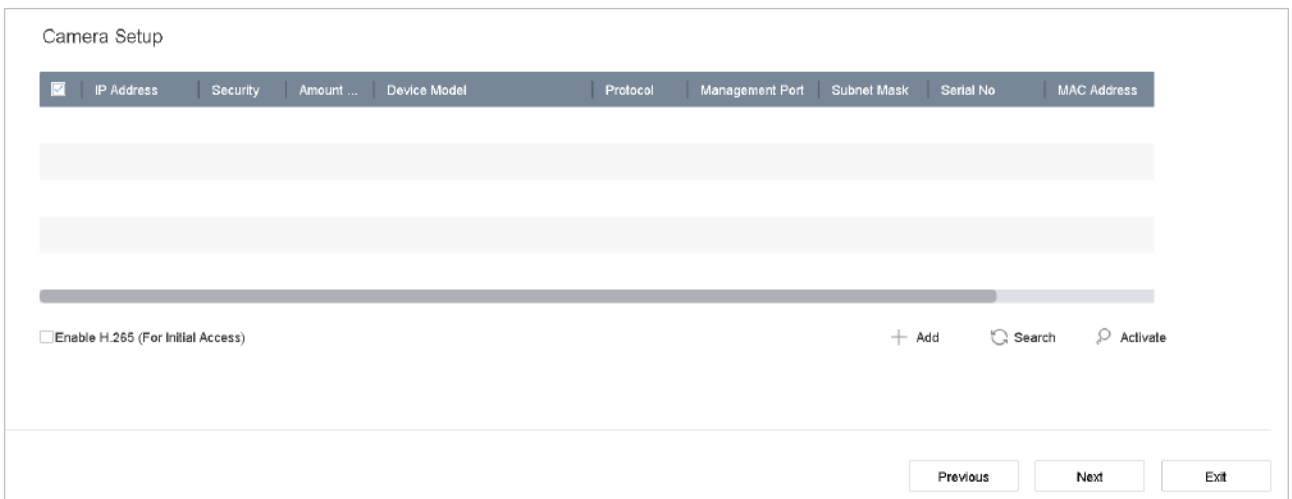

Figure 2-10 Search for IP Cameras

Step 6 Enter the Platform Access and configure the Hik-Connect settings.

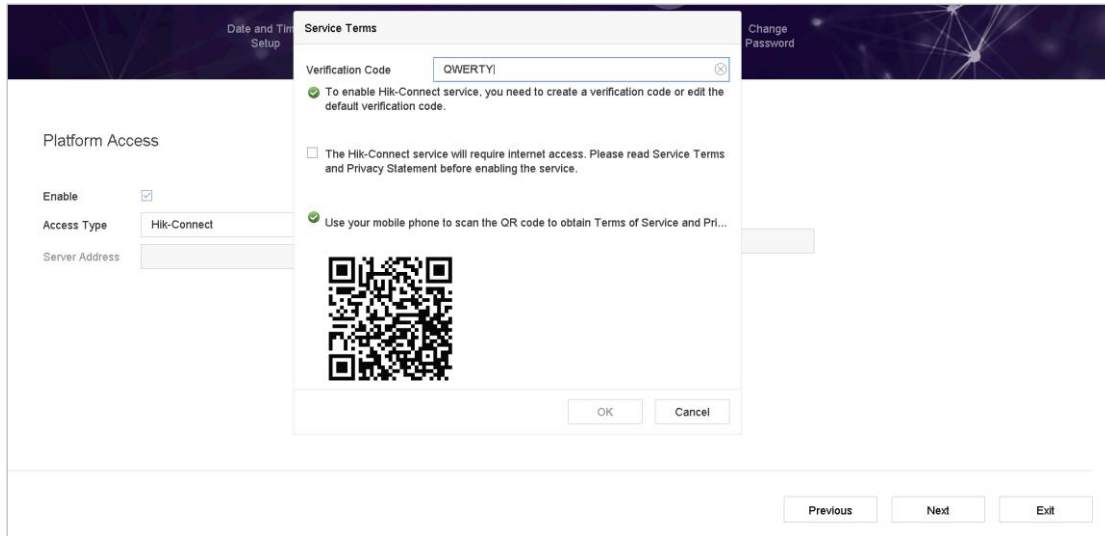



Figure 2-11 Hik-Connect Access

Step 7 Click **Next** to enter the **Change Password** interface to create the new admin password if required.



Figure 2-12 Change Password

NOTE

You can enter click the  to show the characters input.

- 1) Check the checkbox of **New Admin Password**.
- 2) Enter the original password in the text field of **Admin Password**
- 3) Input the same password in the text field of **New Password** and **Confirm**.
- 4) Check the **Unlock Pattern** to enable the unlock pattern login.

 **WARNING**

We highly recommend you create a strong password of your own choosing (Using a minimum of 8 characters, including at least three of the following categories: upper case letters, lower case letters, numbers, and special characters.) in order to increase the security of your product. And we recommend you reset your password regularly, especially in the high security system, resetting the password monthly or weekly can better protect your product.

Step 8 Click **OK** to complete the startup Setup Wizard.

2.6 Enter Main Menu







Purpose:



After you have completed the wizard, you can right click on the screen to enter the main menu bar. Refer to the following figure and table for the description of main menu and sub-menus.



Figure 2-13 Main Menu Bar

Table 2-1 Description of Icons

| Icon | Description |
|---|--------------------|
|  | Live View |
|  | Playback |
|  | File Management |
|  | Smart Analysis |
|  | Camera Management |
|  | Storage Management |

| | |
|---|---------------------|
|  | System Management |
|  | System Maintenance: |

2.7 System Operation

2.7.1 Log out

Purpose:

After logging out, the monitor turns to the live view mode and if you want to perform any operations, you need to enter user name and password to log in again.

Step 1 Click  on the menu bar.

Step 2 Click **Logout**.

 **NOTE**

After you have logged out the system, menu operation on the screen is invalid. It is required to input a user name and password to unlock the system.

2.7.2 Shut Down the Device

Step 1 Click  on the menu bar.

Step 2 Click the **Shutdown**.

Step 3 Click the **Yes**.

 **NOTE**

Do not conduct power off operation again when the system is shutting down.

2.7.3 Reboot the Device

Purpose:

From the Shutdown menu, you can also reboot the device.

Step 1 Click  on the menu bar.

Step 2 Click **Reboot** to reboot the device.

Chapter 3 Camera Management

3.1 Add the IP Cameras

3.1.1 Add the IP Camera Manually

Purpose:

Before you can get live video or record the video files, you should add the network cameras to the connection list of the device.

Before you start:

Ensure the network connection is valid and correct, and the IP camera to add has already been activated.

Step 1 Click  on the main menu bar.

Step 2 Click **Camera > IP Camera > Custom Add** on the title bar or click  in the idle channel window to enter the Add IP Camera interface.

Step 3 Enter IP address, protocol, management port, and other information of the IP camera to add.

Step 4 Enter the login user name and password of the IP camera.

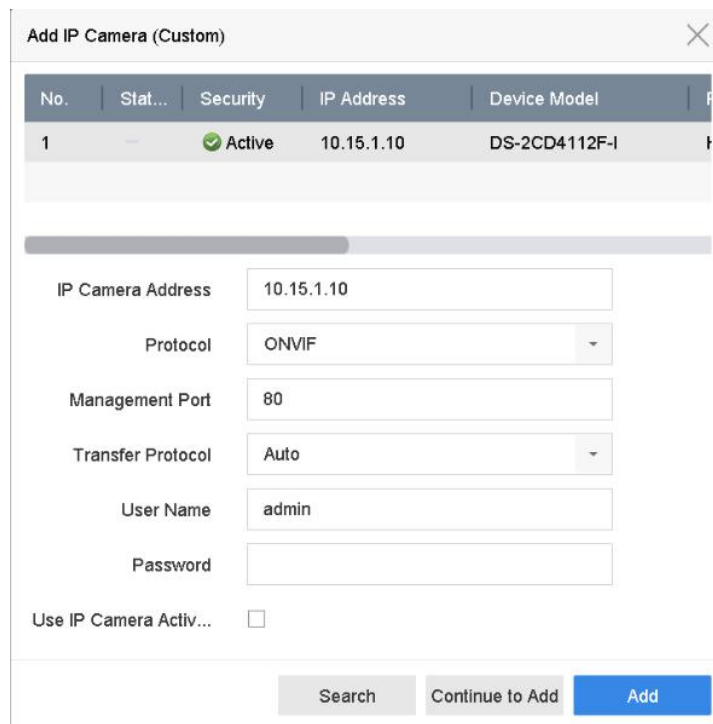

| No. | Stat... | Security | IP Address | Device Model |
|-----|---------|----------|------------|---------------|
| 1 | — | Active | 10.15.1.10 | DS-2CD4112F-I |

IP Camera Address: 10.15.1.10

Protocol: ONVIF

Management Port: 80

Transfer Protocol: Auto

User Name: admin

Password: []

Use IP Camera Activ...

Buttons: Search, Continue to Add, Add

Figure 3-1 Add IP Camera

Step 5 Click **Add** to finish the adding of the IP camera.

Step 6 (Optional) Click **Continue to Add** to continue to add other IP cameras.

3.1.2 Add the Automatically Searched Online IP Cameras

Step 1 On the **IP Camera** interface, click the **Number of Unadded Online Device** to expand the panel.

Step 2 Select the automatically searched online devices.

Step 3 Click **Add**.

The screenshot shows a web interface for managing IP cameras. At the top, there are buttons for '+ Add', 'Refresh', and 'Activate', along with a search box labeled 'Enter a keyword.'. Below this is a table with the following columns: No., Status, Security, IP Address, Edit, Device Model, Protocol, and Management ... The table contains one row with the following data: No. 1, Status Active (with a green checkmark), Security (empty), IP Address 10.15.1.10, Edit (with a pencil icon), Device Model DS-2CD4112F-I, Protocol HIKVISION, and Management 8000.

| No. | Status | Security | IP Address | Edit | Device Model | Protocol | Management ... |
|-----|--------|----------|------------|------|---------------|-----------|----------------|
| 1 | Active | | 10.15.1.10 | | DS-2CD4112F-I | HIKVISION | 8000 |

Figure 3-2 Add IP Camera

NOTE

- If the IP camera to add has not been activated, you can activate it from the IP camera list on the camera management interface.
- For iDS-7200HQHI-K/S and iDS-7200HUHI-K/S series, when IP camera is added, the device will automatically switch the resolution to WD1/D1 and switch the bit rate to 512 Kbps.

3.1.3 Connecting PoC Cameras

Before you start

- Ensure your device supports PoC (Power over Coaxitron) cameras connection.
- Connect the PoC camera to the DVR.

Purpose

The device will detect the connected PoC cameras automatically, manage the power consumption via the coaxial communication, and provide power to the cameras via coaxitron.

Step 1 Go to **Menu > Camera > PoC Status**.

Step 2 Turn on the PoC for the channel(s) as your desire.

Step 3 Check the status of connected PoC camera.

- If the power consumption of the DVR is lower than that of AF camera, when AF or AT camera is connected, there is no video and “Insufficient Power for PoC” is overlaid on the live view image.
- If the power consumption of the DVR is higher than that of the AF camera and lower than that of the AT camera, when AF camera is connected, it is powered on normally; when AT camera is connected, it is powered on and then powered off, and there is no video and “Insufficient Power for PoC” is overlaid on the live view image.
- If the power consumption of the DVR is higher than that of the AT camera, when AF or AT camera is connected, it is powered on normally.

Step 4 Check the connected AF or AT camera number and the connectable camera number.

| Channel | On | Off | Status |
|---------|----------------------------------|-----------------------|--------|
| A1 | <input checked="" type="radio"/> | <input type="radio"/> | |
| A2 | <input checked="" type="radio"/> | <input type="radio"/> | |
| A3 | <input checked="" type="radio"/> | <input type="radio"/> | |
| A4 | <input checked="" type="radio"/> | <input type="radio"/> | |
| | | | |
| | | | |
| | | | |
| | | | |
| | | | |

0 PoC AF camera(s) and 1 PoC AT camera(s) has been connected, 3 PoC AF camera(s) or 3 PoC AT camera(s) can be added.

Figure 3-3 PoC Status

NOTE

- Only Hikvision PoC camera is supported.
- The maximum connectable AT/AF camera number varies with different models.

WARNING

Please turn off the PoC function if the camera does not support PoC, or the camera is not produced by Hikvision. Otherwise, it may result in permanent damage to the camera or DVR.

3.1.4 Configure Signal Input Channel

Purpose

You can configure the analog and IP signal input types.

Step 1 Click  on the main menu bar.

Step 2 Click **Camera > Analog**.

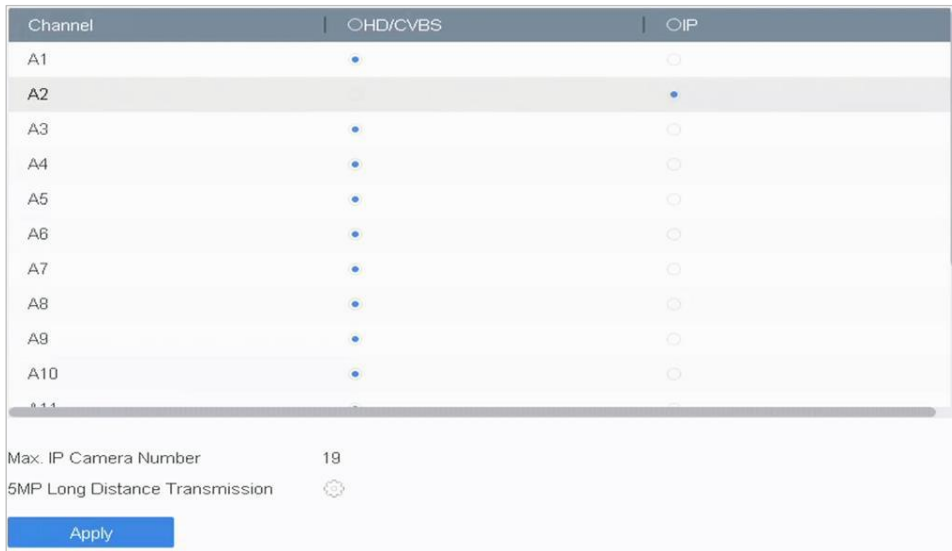

Figure 3-4 Signal Input Status

Step 3 Check the checkbox to select different signal input types: HD/CVBS and IP. If you select **HD/CVBS**, four types of analog signal inputs including Turbo HD, AHD, HDCVI, and CVBS can be connected randomly for the selected channel. If you select **IP**, IP camera can be connected for the selected channel.

Step 4 Click **Apply** to save the settings.

 **NOTE**

You can view the max. accessible number of IP cameras in the **Max. IP Camera Number** text field. Refer to the specifications for the max. accessible IP camera number of different models.

3.1.5 Configuring 5 MP Long Distance Transmission

 **NOTE**

This chapter is only applicable to HUH1 and HTH1 series DVR.

Purpose

For HUH1 and HTH1 series DVR, you can configure 5 MP long distance transmission on the Signal Input Status interface.

Step 1 Click  on the main menu bar.

Step 2 Click **Camera > Analog**.

Step 3 Click  to enter the 5 MP Long Distance Transmission Settings interface.

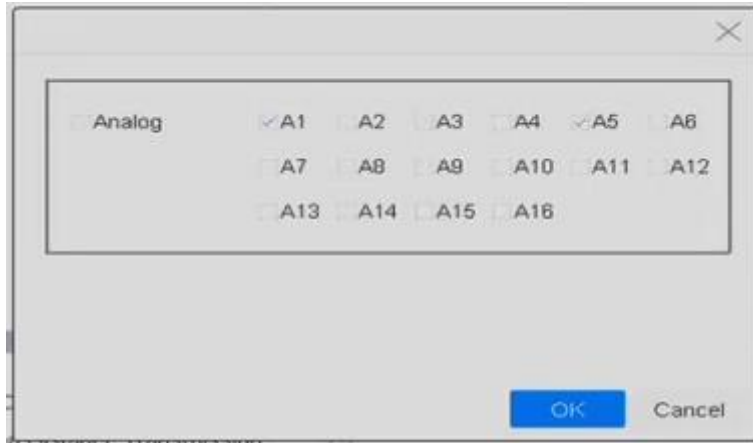

Figure 3-5 5 MP Long Distance Transmission Settings

Step 4 Select channel(s) to enable 5 MP Long Distance Transmission.

Step 5 Click **OK**.

Step 6 Click **Apply** to save the settings.

3.2 Enable the H.265 Stream Access

Purpose:

The device can automatically switch to the H.265 stream of IP camera (which supports H.265 video format) for the initial access.

Step 1 Click  on the main menu bar.

Step 2 Click **Camera > IP Camera > More Settings > H.265 Auto Switch Configuration** at the top taskbar.

Step 3 Check **Enable H.265 (For Initial Access)**.

Step 4 Click **OK**.

3.3 Upgrade the IP Camera

Purpose:

The IP camera can be remotely upgraded through the device.

NOTE

Plug the U-flash drive with the IP camera's firmware upgrade file to the device.

Step 1 Click  on the main menu bar.

Step 2 On the camera management interface, select a camera.

Step 3 Click **Camera > IP Camera > More Settings > Upgrade** at the top taskbar.

Step 4 Select the firmware upgrade file from the U-flash drive.

Step 5 Click **Upgrade**.

Result:

The IP camera will reboot automatically after the upgrading completes.

Chapter 4 Camera Settings

4.1 Configure OSD Settings

Purpose:

You can configure the OSD (On-screen Display) settings for the camera, including date/time, camera name, etc.

Step 1 Click  on the main menu bar.

Step 2 Click **Display**.

Step 3 Select the camera from the drop-down list.

Step 4 Edit the name in the **Camera Name** text field.

Step 5 Check the checkbox of the **Display Name**, **Display Date** and **Display Week** if you want to show the information on the image.

Step 6 Set the date format, time format, and display mode.

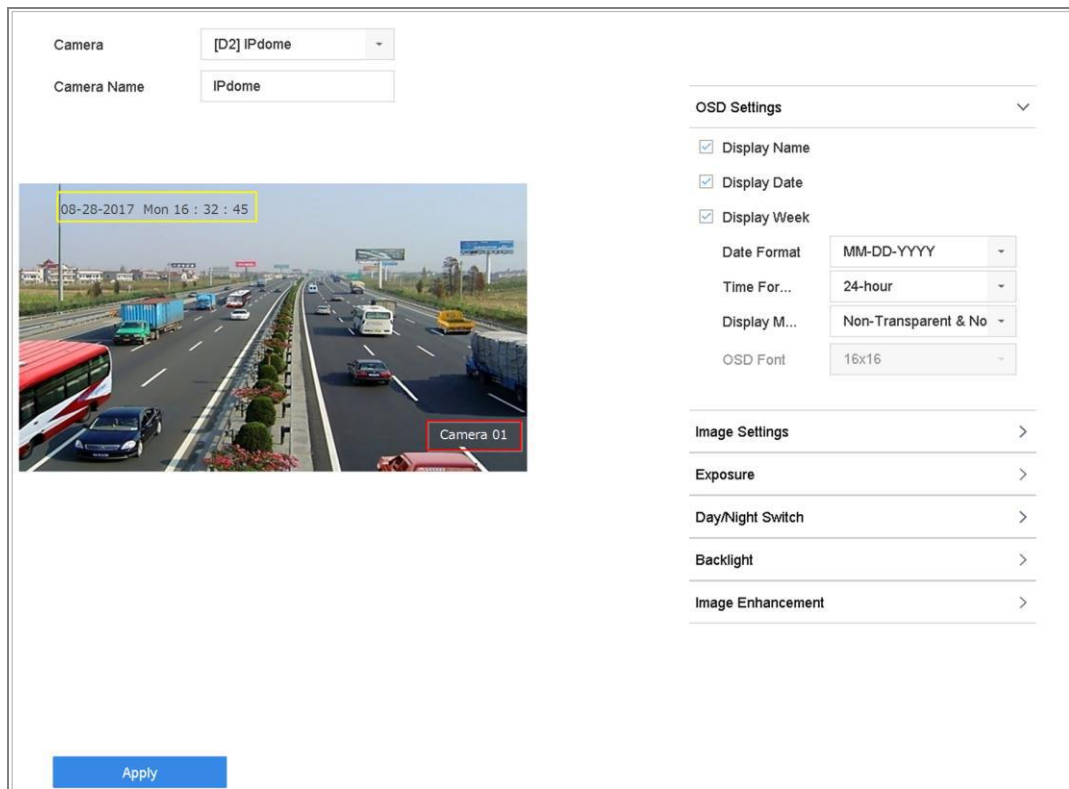

Figure 4-1 OSD Configuration Interface

Step 7 You can use the mouse to click and drag the text frame on the preview window to adjust the OSD position.

Step 8 Click the **Apply** button to apply the settings.

4.2 Configure Privacy Mask

Purpose:

The privacy mask can be used to protect personal privacy by concealing parts of the image from view or recording with a masked area.

Step 1 Click  on the main menu bar.

Step 2 Click **Privacy Mask**.

Step 3 Select the camera to set privacy mask.

Step 4 Click the checkbox of **Enable** to enable this feature.

Step 5 Use the mouse to draw a zone on the window. The zones will be marked with different frame colors.

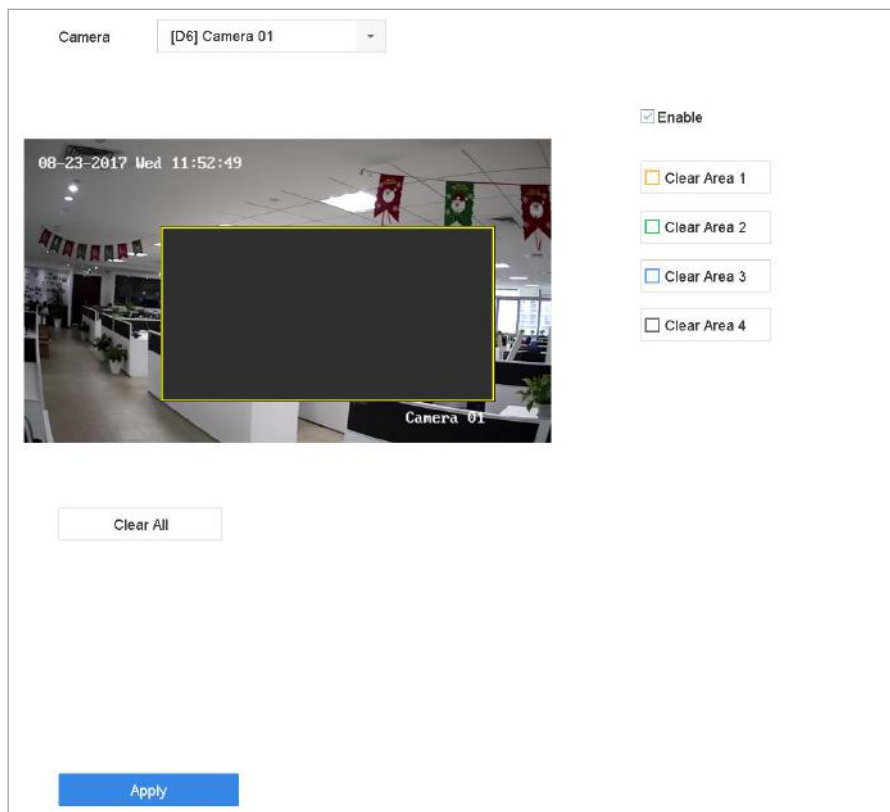

Figure 4-2 Privacy Mask Settings Interface

NOTE

Up to 4 privacy masks zones can be configured and the size of each area can be adjusted.

Related Operation:

The configured privacy mask zones on the window can be cleared by clicking the corresponding Clear Zone1-4 icons on the right side of the window, or click **Clear All** to clear all zones.

Step 6 Click **Apply** to save the settings.

4.3 Configure the Video Parameters

Purpose:

You can customize the image parameters including the brightness, contrast, saturation for the live view and recording effect.

Step 1 Click  on the main menu bar.

Step 2 Click **Display**.

Step 3 Select the camera from the drop-down list.

Step 4 Adjust the slider or click on the up/down arrow to set the value of the brightness, contrast or saturation.

Step 5 Click **Apply** to save the settings.

4.4 Configure the Day/Night Switch

Purpose:

The camera can be set to day, night or auto switch mode according to the surrounding illumination conditions.

Step 1 Click  on the main menu bar.

Step 2 Click **Display**.

Step 3 Select the camera from the drop-down list.

Step 4 Select **Day/Night Switch** to **Day**, **Night**, **Auto** or **Auto-Switch**.

Auto: The camera switches between the day mode and the night mode according to the illumination automatically.

The sensitivity ranges from 0 to 7, and the higher sensitivity results in the more easily to trigger the mode switch.

The switch time refers to the interval time between the day/night switch. You can set it from 5 sec to 120 sec.

Auto-Switch: The camera switches the day mode and the night mode according to the start time and end time you set.

Step 5 Click the **Apply** to save the settings.

4.5 Configure Other Camera Parameters

Purpose:

For the connected camera, you can configure the camera parameters including the exposure mode, backlight and image enhancement.

Step 1 Click  on the main menu bar.

Step 2 Click **Display**.

Step 3 Select the camera from the drop-down list.

Step 4 Configure the camera parameters.

- **Exposure:** Set the exposure time (1/10000 to 1 sec) of camera. The larger exposure value results in the brighter image.
- **Backlight:** Set the wide dynamic range (0 to 100) of the camera. When the surrounding illumination and the object have larger difference in brightness, you should set the WDR value.
- **Image Enhancement:** For optimized image contrast enhancement.

Step 5 Click the **Apply** to save the settings.

Chapter 5 Live View

Live view shows you the video image getting from each camera in real time.

5.1 Start Live View

Click  on the main menu bar to enter the live view.

- You can select a window and double click a camera from the list to play the video from the camera in the selected window.
- Use the toolbar at the playing window bottom to realize the capture, instant playback, audio on/off, digital zoom, live view strategy, show information and start/stop recording, etc.

5.1.1 Digital Zoom

Purpose:

Digital Zoom is for zooming in the live image. You can zoom in the image to different proportions (1 to 16X).

Step 1 In the live view mode, click  from the toolbar to enter the digital zoom interface.

Step 2 You can move the sliding bar or scroll the mouse wheel to zoom in/out the image to different proportions (1 to 16X).



Figure 5-1 Digital Zoom

5.1.2 Live View Strategy

Step 1 In the live view mode, click  to enter the digital zoom operation interface in full screen mode.





Step 2 Select the live view strategy to **Real-time**, **Balanced** or **Fluency**.

5.2 Target Detection

Purpose:

In live view mode, the target detection function can be used to detect the human motion/face/vehicle/human body during the last 5 seconds and the following 10 seconds.

Step 1 In the live view mode, click **Target Detection** tab to enter the target detection interface.

Step 2 Check the checkbox of the icons to select different detection types: motion detection () , vehicle detection () , face detection () and human body detection () .



Step 3 You can select the historical analysis () or the real-time analysis () to obtain the results.



Figure 5-2 Target Detection

Result:

The smart analysis results of the detection are displayed in the list. Optionally, click a result in list to play the related video.

5.3 Configure Live View Settings

Purpose:

Live View settings can be customized according to different needs. You can configure the output interface, dwell time for screen to be shown, mute or turning on the audio, the screen number for each channel, etc.

Step 1 Go to **System > Live View > General**.

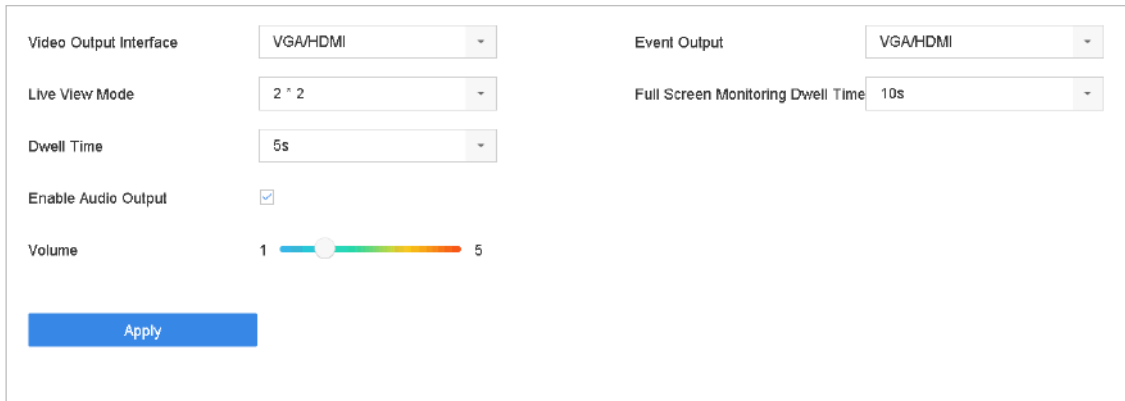

| | | | |
|------------------------|---|-----------------------------------|----------|
| Video Output Interface | VGA/HDMI | Event Output | VGA/HDMI |
| Live View Mode | 2 * 2 | Full Screen Monitoring Dwell Time | 10s |
| Dwell Time | 5s | | |
| Enable Audio Output | <input checked="" type="checkbox"/> | | |
| Volume | 1  5 | | |

Apply

Figure 5-3 Live View-General

Step 2 Configure the live view parameters.

- **Video Output Interface:** Select the video output to configure.
- **Live View Mode:** Select the display mode for live view, e.g., 2*2, 1*5, etc.
- **Dwell Time:** The time in seconds to dwell between switching of cameras when enabling auto-switch in Live View.
- **Enable Audio Output:** Enable/disable audio output for the selected video output.
- **Volume:** Adjust the volume of live view, playback and two-way audio for the selected output interface.
- **Event Output:** Select the output to show event video.
- **Full Screen Monitoring Dwell Time:** Set the time in seconds to show alarm event screen.

Step 3 Click **OK** to save the settings.

5.4 Configure Live View Layout

Step 1 Go to **System> Live View>View**.

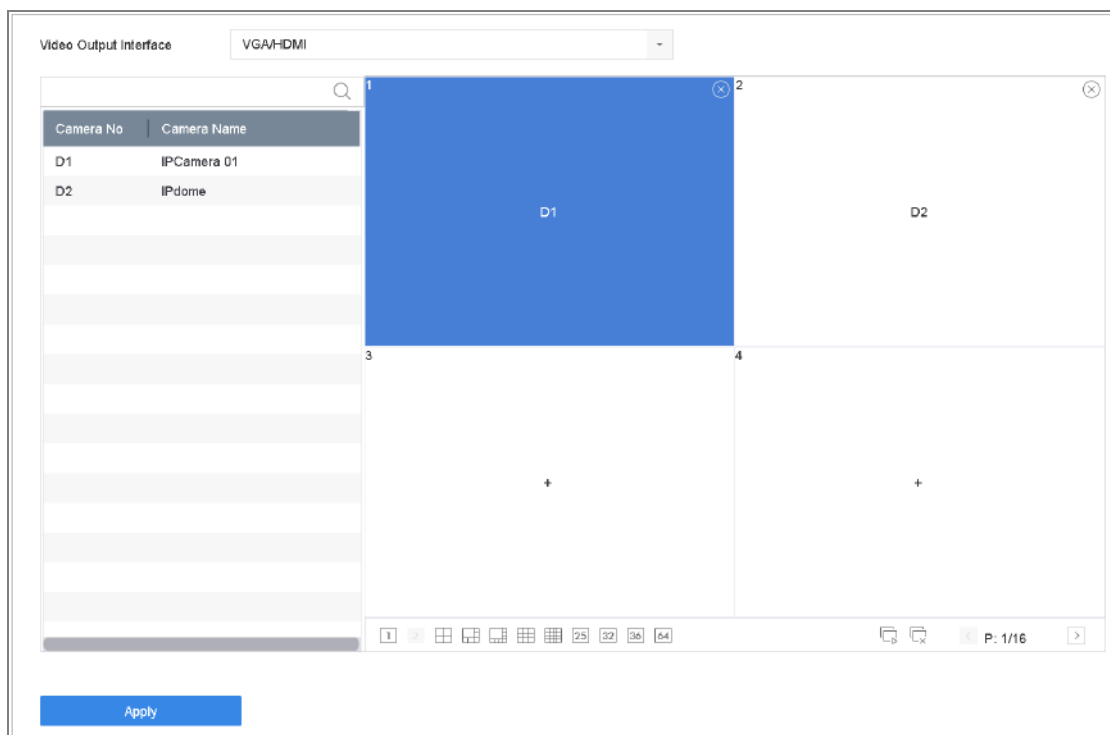

Figure 5-4 Live View

Step 2 Select the video output interface, e.g., HDMI/ VGA or channel-zero.

Step 3 Select a window division mode from the toolbar.



Step 4 Select a division window, and double-click on the camera from the list to set the camera to the window.

You can enter the number in the text field to quickly search the camera from the list.

NOTE

You can also click-and-drag the camera to the desired window on the live view interface to set the camera order.

Related Operation:

- Click  button to start live view for all the channels.
- Click  to stop all the live view.

Step 5 Click **Apply** to save the settings.

5.5 Configure Auto-Switch of Cameras

Purpose:

You can set the auto-switch of cameras to play in different display modes.

Step 1 Go to **System > Live View > General**.

Step 2 Set the video output interface, live view mode and dwell time.

- **Video Output Interface:** Select the video output interface.
- **Live View Mode:** Select the display mode for live view, e.g., 2*2, 1*5, etc.
- **Dwell Time:** The time in seconds to dwell between switching of cameras when enabling auto-switch. The range is from 5s to 300s.

Step 3 Go to **View** to set the view layout.

Step 4 Click **OK** to save the settings.

5.6 Configure Channel-zero Encoding

Purpose:

You can enable the channel-zero encoding when you need to get a remote view of many channels in real time from web browser or CMS (Client Management System) software, in order to decrease the bandwidth requirement without affecting the image quality.

Step 1 Go to **System > Live View > General**.

Step 2 Select the video output interface to **Channel-Zero**.

Step 3 Go to **System > Live View > Channel-Zero**.

Step 4 Check the checkbox to enable the channel-zero.

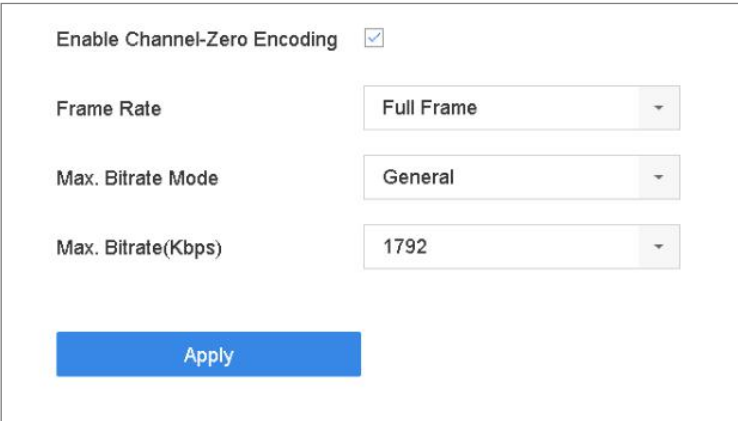

| | |
|--------------------------------------|-------------------------------------|
| Enable Channel-Zero Encoding | <input checked="" type="checkbox"/> |
| Frame Rate | Full Frame |
| Max. Bitrate Mode | General |
| Max. Bitrate(Kbps) | 1792 |
| <input type="button" value="Apply"/> | |

Figure 5-5 Live View- Channel-Zero Encoding

Step 5 Configure the **Frame Rate**, **Max. Bitrate Mode** and Max. Bitrate. The higher frame rate and bitrate settings result in the higher requirement of bandwidth.

Step 6 Click **Apply**.

Result:

You can view all of the channels in one screen using the CMS or web browser.

5.7 Using an Auxiliary Monitor

Certain features of the Live View are also available while in an Aux monitor. These features include:

- **Single Screen:** Switch to a full screen display of the selected camera. Camera can be selected from a dropdown list.
- **Multi-screen:** Switch between different display layout options. Layout options can be selected from a dropdown list.
- **Next Screen:** When displaying less than the maximum number of cameras in Live View, clicking this feature will switch to the next set of displays.
- **Playback:** Enter into Playback mode.
- **PTZ Control:** Enter PTZ Control mode.
- **Main Monitor:** Enter Main operation mode.



In the live view mode of the main output monitor, the menu operation is not available while Aux output mode is enabled.

Chapter 6 PTZ Control

6.1 PTZ Control Wizard

Before you start

Please make sure the connected IP camera supports the PTZ function and is properly connected.

Purpose

Follow the PTZ control wizard to guide you through the basic PTZ operation.

Step 1 Click  on the quick settings toolbar in the live view interface. The PTZ control wizard will pop up as below.

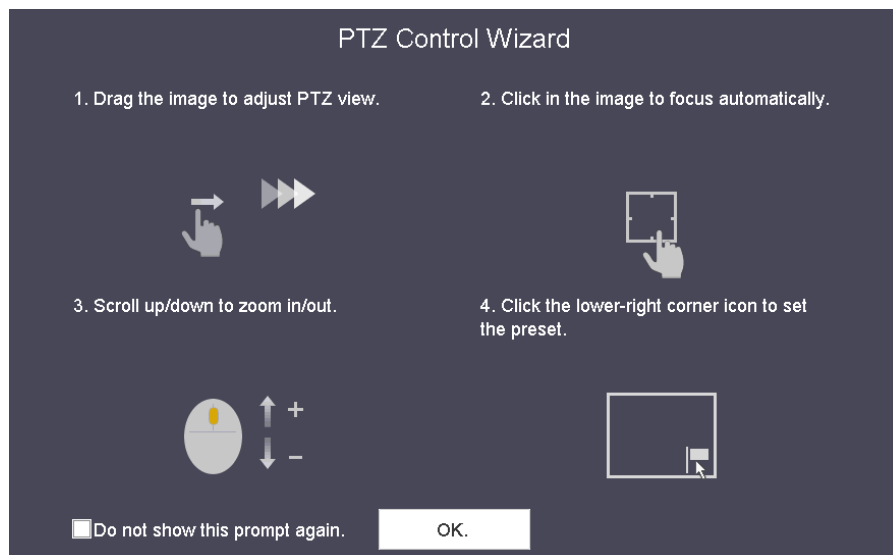

Figure 6-1 PTZ Control Wizard

Step 2 Follow the wizard to adjust the PTZ view, focus, and zoom in/out the camera.

Step 3 (Optional) Check *Do not show this prompt again.*

Step 4 Click **OK** to exit.

6.2 Configure PTZ Parameters

Purpose

Follow the procedure to set the parameters for PTZ. The configuration of the PTZ parameters should be done before you control the PTZ camera.

Step 1 Click  on the quick settings toolbar in the live view interface. The PTZ control panel displays on the right of the interface.

Step 2 Click **PTZ Parameters Settings** to set the PTZ parameters.

The screenshot shows a dialog box titled "PTZ Parameter Settings". It contains the following fields and values:

- Baud Rate: 9600
- Data Bit: 8
- Stop Bit: 1
- Parity: None
- Flow Ctrl: None
- PTZ Protocol: PELCO-C
- Address: 0

Below the Address field, it says "Address range: 0~255". At the bottom right, there are "OK" and "Cancel" buttons.

Figure 6-2 PTZ Parameters Settings

Step 3 Edit the parameters of the PTZ camera.



NOTE

All the parameters should be exactly the same as the PTZ camera parameters.

Step 4 Click **OK** to save the settings.

6.3 Set PTZ Presets, Patrols & Patterns

Before you start:

Please make sure that the presets, patrols and patterns should be supported by PTZ protocols.

6.3.1 Set a Preset

Purpose:

Follow the steps to set the preset location which you want the PTZ camera to point to when an event takes place.

Step 1 Click  on the quick settings toolbar in the live view interface..

Step 2 Use the directional buttons on the PTZ control panel to wheel the camera to the location where you want to set preset, and the zoom and focus operations can be recorded in the preset as well.

Step 3 Click  in the lower right corner of live view to set the preset.



Figure 6-3 Set Preset

Step 4 Select the preset No. (1~255) from the drop-down list.

Step 5 Enter the preset name in the text field.

Step 6 Click **Apply** to save the preset.

Step 7 Repeat steps 2-6 to save more presets.

Step 8 (Optional) Click **Cancel** to cancel the location information of the preset.

Step 9 (Optional) Click  in the lower right corner of live view to view the configured presets.



Figure 6-4 View the Configured Presets

6.3.2 Call a Preset

Purpose:

This feature enables the camera to point to a specified position such as a window when an event takes place.

Step 1 Click  on the quick settings toolbar in the live view interface..

Step 2 Click  in the lower right corner of live view.

Step 3 Select the preset No. from the drop-down list.

Step 4 Click **Call** to call it.



Figure 6-5 Call Preset (1)

Or click  in the lower right corner of live view, and click the configured preset to call it.

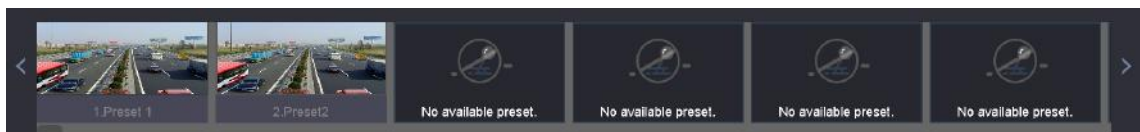

Figure 6-6 Call Preset (2)

6.3.3 Set a Patrol

Purpose:

Patrols can be set to move the PTZ to different key points and have it stay there for a set duration before moving on to the next key point. The key points are corresponding to the presets.

Step 1 Click  on the quick settings toolbar in the live view interface..

Step 2 Click **Patrol** to configure patrol.

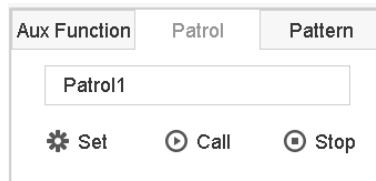

Figure 6-7 Patrol Configuration

Step 3 Select the patrol No. in the text field.

Step 4 Click **Set** to enter the Patrol Settings interface.

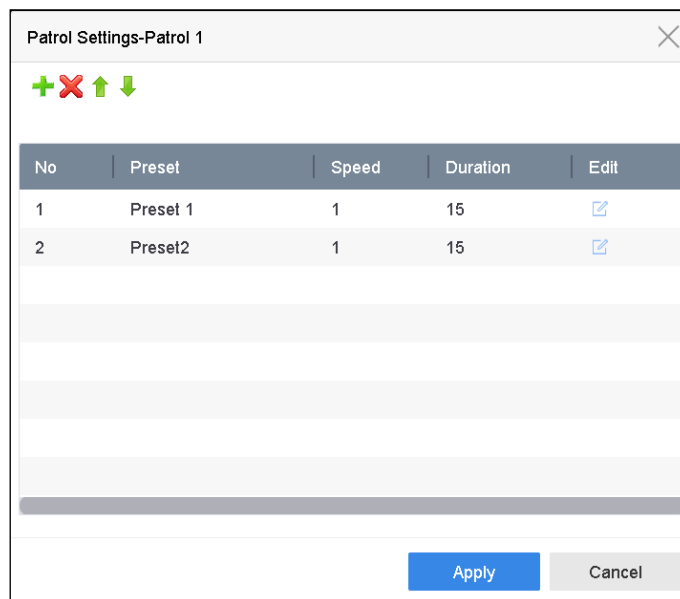



Figure 6-8 Patrol Settings

Step 5 Click  to add key point for the patrol.

| KeyPoint | |
|--|----------|
| Preset | Preset 1 |
| Speed | 1 |
| Duration | 15 |
| <input type="button" value="Apply"/> <input type="button" value="Cancel"/> | |

Figure 6-9 Key Point Configuration

1) Configure key point parameters.

Preset: It determines the order at which the PTZ will follow while cycling through the patrol.

Speed: It defines the speed at which the PTZ will move from one key point to the next.

Duration: It refers to the time span to stay at the corresponding key point.

2) Click **Apply** to save the key points to the patrol.

Step 6 (Optional) Click  to edit the added key point.

| KeyPoint | |
|--|----------|
| Preset | Preset 1 |
| Speed | 1 |
| Duration | 15 |
| <input type="button" value="Apply"/> <input type="button" value="Cancel"/> | |

Figure 6-10 Edit Key Point

Step 7 (Optional) Select a key point and click  to delete it.

Step 8 (Optional) Click  or  to adjust the key point order.

Step 9 Click **Apply** to save the settings of the patrol.

Step 10 Repeat steps 3-9 to set more patrols.

6.3.4 Call a Patrol

Purpose:

Calling a patrol makes the PTZ to move according to the predefined patrol path.

Step 1 Click  on the quick settings toolbar in the live view interface..

The PTZ control panel displays on the right of the interface.

Step 2 Click **Patrol** on the PTZ control panel.

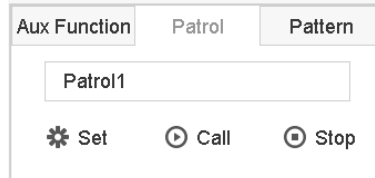

Figure 6-11 Patrol Configuration

Step 3 Select a patrol in the text field.

Step 4 Click **Call** to call it.

Step 5 (Optional) Click **Stop** to stop calling it.

6.3.5 Set a Pattern

Purpose:

Patterns can be set by recording the movement of the PTZ. You can call the pattern to make the PTZ movement according to the predefined path.

Step 1 Click  on the quick settings toolbar in the live view interface..

The PTZ control panel displays on the right of the interface.

Step 2 Click **Pattern** to configure pattern.

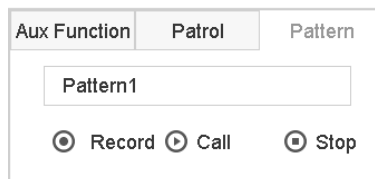

Figure 6-12 Pattern Configuration

Step 3 Select the pattern No. in the text field.

Step 4 Set the pattern.

- 1) Click **Record** to start recording.
- 2) Click corresponding buttons on the control panel to move the PTZ camera.
- 3) Click **Stop** to stop recording.

The movement of the PTZ is recorded as the pattern.

Step 5 Repeat steps 3-4 to set more patterns.

6.3.6 Call a Pattern

Purpose:

Follow the procedure to move the PTZ camera according to the predefined patterns.

Step 1 Click  on the quick settings toolbar in the live view interface.

The PTZ control panel displays on the right of the interface.

Step 2 Click **Pattern** to configure pattern.

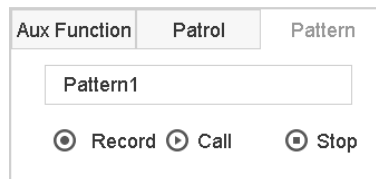

Figure 6-13 Pattern Configuration

Step 3 Select a pattern in the text field.

Step 4 Click **Call** to call it.

Step 5 (Optional) Click **Stop** to stop calling it.

6.3.7 Set Linear Scan Limits

Before you start:

Please make sure the connected IP camera supports the PTZ function, and is properly connected.

Purpose:

The linear scan can be enabled to trigger the scan in the horizontal direction in the predefined range.



This function is supported by some certain models.

Step 1 Click  on the quick settings toolbar in the live view interface..

The PTZ control panel displays on the right of the interface.

Step 2 Click the directional buttons to wheel the camera to the location where you want to set the limit, and click **Left Limit** or **Right Limit** to link the location to the corresponding limit.



The speed dome starts linear scan from the left limit to the right limit, and you must set the left limit on the left side of the right limit, as well the angle from the left limit to the right limit should be no more than 180°.

6.3.8 Call Linear Scan



Before operating this function, make sure the connected camera supports the linear scan and is in HIKVISION protocol.

Purpose:

Follow the procedure to call the linear scan in the predefined scan range.

Step 1 Click  on the quick settings toolbar in the live view interface..

Step 2 Click **Linear Scan** to start the linear scan and click it again to stop it.

Step 3 (Optional) Click **Restore** to clear the defined left limit and right limit data.



Reboot the camera to take the settings into effect.

6.3.9 One-touch Park



Before operating this function, make sure the connected camera supports the linear scan and is in HIKVISION protocol.

Purpose

For some certain model of the speed dome, it can be configured to start a predefined park action (scan, preset, patrol and etc.) automatically after a period of inactivity (park time).

Step 1 Click  on the quick settings toolbar in the live view interface..

Step 2 Click **Park (Quick Patrol)**, **Park (Patrol 1)** or **Park (Preset 1)** to activate the park action.

Park (Quick Patrol): The dome starts patrol from the predefined preset 1 to preset 32 in order after the park time. The undefined preset will be skipped.

Park (Patrol 1): The dome starts moving according to the predefined patrol 1 path after the park time.

Park (Preset 1): The dome moves to the predefined preset 1 location after the park time.



The park time can only be set via the speed dome configuration interface. The value is 5s by default.

Step 3 Click **Stop Park (Quick Patrol)**, **Stop Park (Patrol 1)** or **Stop Park (Preset 1)** to inactivate it.

6.4 Auxiliary Functions

Before you start

Please make sure the connected IP camera supports the PTZ function, and is properly connected.

Purpose

You can operate the auxiliary functions including light, wiper, and center on the PTZ control panel.

Step 1 Click  on the quick settings toolbar in the live view interface..

Step 2 Click **Aux Function**.

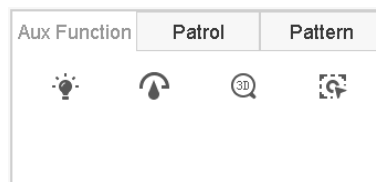





Figure 6-14 Aux Function Configuration

Step 3 Click the icons to operate the aux functions. See the table for the description of the icons.

Table 6-1 Description of Aux Functions Icons

| Icon | Description |
|---|--------------|
|  | Light on/off |
|  | Wiper on/off |
|  | Center |

Chapter 7 Storage

7.1 Storage Device Management

7.1.1 Install the HDD

Before startup of the device, install and connect the HDD to the device. Refer to the Quick Start Guide for the installation instructions.

7.1.2 Add the Network Disk

You can add the allocated NAS or disk of IP SAN to device, and use it as network HDD.

Adding NAS

- Step 1 Go to **Storage > Storage Device**.
- Step 2 Click **Add** to enter the **Custom Add** interface.
- Step 3 Select the type to **NetHDD**.
- Step 4 Select the type to **NAS**.
- Step 5 Enter **NetHDD IP** in the text field.
- Step 6 Click **Search** to search the available NAS disks.

The screenshot shows a 'Custom Add' dialog box with the following fields and values:

- NetHDD:** NetHDD 1
- Type:** NAS
- NetHDD IP:** 120 . 36 . 2 . 39
- NetHDD Directory:** /nas/device1/11|

Buttons: Search, OK, Cancel

Figure 7-1 Add NAS Disk

Step 7 Select the NAS disk from the list, or you can manually enter the directory in the text field of NetHDD Directory.

Step 8 Click **OK** to complete the adding of the NAS disk.

Result:

After having successfully added the NAS disk, return to the HDD Information menu. The added NetHDD will be displayed in the list.

Adding IP SAN

Step 1 Go to **Storage > Storage Device**.

Step 2 Click **Add** to enter the **Custom Add** interface.

Step 3 Select **NetHDD** from the drop-down list.

Step 4 Select **Type** to **IP SAN**.

Step 5 Enter **NetHDD IP** in the text field.

Step 6 Click **Search** to search the available IP SAN disks.

Step 7 Select the IP SAN disk from the list.

Step 8 Click **OK** to complete the adding of the IP SAN disk.



Up to 1 IP SAN disk can be added.

The screenshot shows a 'Custom Add' dialog box with the following fields and values:

- NetHDD:** NetHDD 1 (dropdown menu)
- Type:** IP SAN (dropdown menu)
- NetHDD IP:** 120 . 36 . 2 . 39 (text field)
- NetHDD Directory:** iqn.2008-06.storos.1-2 (text field with a search button to its right)

Buttons at the bottom: OK, Cancel

Figure 7-2 Add IP SAN Disk

Result:

After having successfully added the IP SAN disk, return to the **HDD Information** menu. The added NetHDD will be displayed in the list.



If the installed HDD or NetHDD is uninitialized, please select it and click **Init** for initialization.

7.1.3 Configure eSATA for Data Storage

Purpose:

When there is an external eSATA device connected to device, you can configure eSATA for the data storage, and you can manage the eSATA in the device.

Step 1 Click **Storage>Advanced**.

Step 2 Select the usage type to **Export** or **Record/Capture** from the dropdown list of **Usage**.

- **Export:** Use the eSATA for backup.
- **Record/Capture:** Use the eSATA for record/capture. Refer to the following steps for operating instructions.



Figure 7-3 Set eSATA Mode

Step 3 When **Usage** type is selected to **Record/Capture**, enter the storage device interface.

Step 4 Edit the property of the selected eSATA, or initialize it is required.

7.2 Storage Mode

7.2.1 Configure HDD Group

Purpose:

Multiple HDDs can be managed in groups. Video from specified channels can be recorded onto a particular HDD group through HDD settings.

Step 1 Go to **Storage> Storage Device**.

Step 2 Select the HDD to set the group.

| + Add | | Init | | Total Capacity 1863.03GB | | | | Free Space 1702.00GB | |
|-------------------------------------|-------|----------|--------|--------------------------|-------|------------|-------|----------------------|--------|
| <input type="checkbox"/> | Label | Capacity | Status | Property | Type | Free Space | Group | Edit | Delete |
| <input checked="" type="checkbox"/> | 5 | 931.52GB | Normal | RAW | Local | 871.00GB | 2 | | |
| <input checked="" type="checkbox"/> | 7 | 931.52GB | Normal | RAW | Local | 831.00GB | 1 | | |

Figure 7-4 Storage Device

Step 3 Click  to enter the **Local HDD Settings** interface.

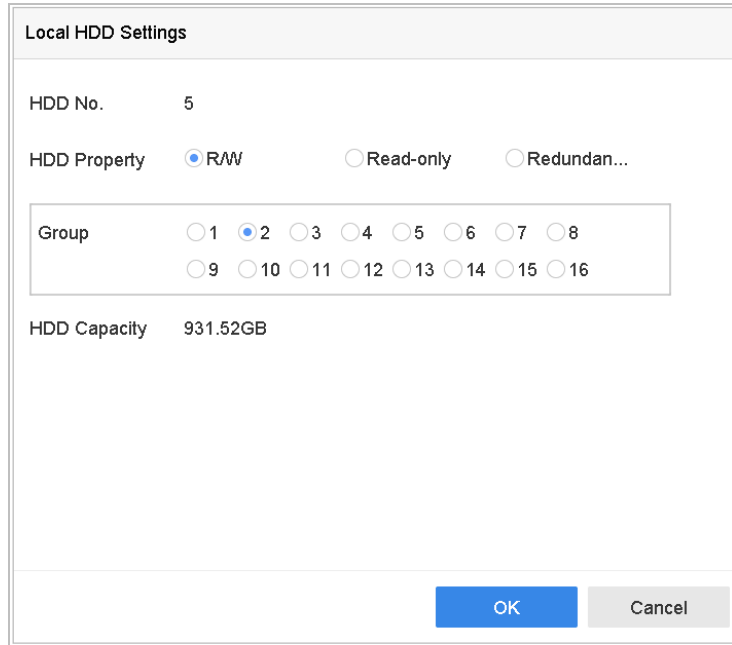

Figure 7-5 Local HDD Settings

Step 4 Select the Group number for the current HDD.

Step 5 Click **OK**.

 **NOTE**

Regroup the cameras for HDD if the HDD group number is changed.

Step 6 Go to **Storage> Storage Mode**.

Step 7 Select **Mode** to **Group**.

Step 8 Select the group No. from **Record on HDD Group**.

Step 9 Select the IP camera(s) to record/capture on the HDD group.

Mode Quota Group

Record on HDD Group

| | | | | | | | | |
|------------------------------------|--|------------------------------|---|---|--|--|--|--|
| <input type="checkbox"/> IP Camera | <input checked="" type="checkbox"/> D1 | <input type="checkbox"/> D2 | <input checked="" type="checkbox"/> D3 | <input checked="" type="checkbox"/> D4 | <input checked="" type="checkbox"/> D5 | <input checked="" type="checkbox"/> D6 | <input checked="" type="checkbox"/> D7 | <input checked="" type="checkbox"/> D8 |
| | <input type="checkbox"/> D9 | <input type="checkbox"/> D10 | <input checked="" type="checkbox"/> D11 | <input checked="" type="checkbox"/> D12 | <input type="checkbox"/> D13 | <input type="checkbox"/> D14 | <input type="checkbox"/> D15 | <input type="checkbox"/> D16 |
| | <input type="checkbox"/> D17 | <input type="checkbox"/> D18 | <input type="checkbox"/> D19 | <input type="checkbox"/> D20 | <input type="checkbox"/> D21 | <input type="checkbox"/> D22 | <input type="checkbox"/> D23 | <input type="checkbox"/> D24 |
| | <input type="checkbox"/> D25 | <input type="checkbox"/> D26 | <input type="checkbox"/> D27 | <input type="checkbox"/> D28 | <input type="checkbox"/> D29 | <input type="checkbox"/> D30 | <input type="checkbox"/> D31 | <input type="checkbox"/> D32 |
| | <input type="checkbox"/> D33 | <input type="checkbox"/> D34 | <input type="checkbox"/> D35 | <input type="checkbox"/> D36 | <input type="checkbox"/> D37 | <input type="checkbox"/> D38 | <input type="checkbox"/> D39 | <input type="checkbox"/> D40 |
| | <input type="checkbox"/> D41 | <input type="checkbox"/> D42 | <input type="checkbox"/> D43 | <input type="checkbox"/> D44 | <input type="checkbox"/> D45 | <input type="checkbox"/> D46 | <input type="checkbox"/> D47 | <input type="checkbox"/> D48 |
| | <input type="checkbox"/> D49 | <input type="checkbox"/> D50 | <input type="checkbox"/> D51 | <input type="checkbox"/> D52 | <input type="checkbox"/> D53 | <input type="checkbox"/> D54 | <input type="checkbox"/> D55 | <input type="checkbox"/> D56 |

Figure 7-6 Storage Mode-HDD Group

Step 10 Click **Apply**.



Reboot the device to activate the new storage mode settings.

7.2.2 Configure HDD Quota

Purpose:

Each camera can be configured with allocated quota for the storage of recorded files or captured pictures.

Step 1 Go to **Storage > Storage Mode**.

Step 2 Select **Mode** to **Quota**.

Step 3 Select a camera to set quota.

Step 4 Enter the storage capacity of **Max. Record Capacity (GB)** and **Max. Picture Capacity (GB)**.

Mode Quota Group

Camera [D1] IPCamera 01

Used Record Capacity 18.00GB

Used Picture Capacity 2048.00MB

HDD Capacity (GB) 1863

Max. Record Capacity (GB) 1500

Max. Picture Capacity (GB) 50

⚠ Free Quota Space 313 GB

Copy to Apply

Figure 7-7 Storage Mode-HDD Quota

Step 5 (Optional) You can click **Copy to** if you want to copy the quota settings of the current camera to other cameras.

Step 6 Click **Apply** to apply the settings. Reboot the device to activate the new storage mode settings.

 **NOTE**

When the quota capacity is set to 0, all cameras will use the total capacity of HDD for record and picture capture.

7.3 Recording Parameters

7.3.1 Main Stream

The Main Stream refers to the primary stream that affects data recorded to the hard disk drive and will directly determine your recording quality and image size.

Comparing with the sub-stream, the main stream can provide a higher quality video with higher resolution and frame rate.

Frame Rate (FPS - Frames Per Second): refers to how many frames are captured each second. A higher frame rate is advantageous when there is movement in the video stream, as it maintains image quality throughout.

Resolution: Image resolution is a measure of how much detail a digital image can hold: the greater the resolution, the greater the level of detail. Resolution can be specified as the number of pixel-columns (width) by the number of pixel-rows (height), e.g.,1024×768.

Bitrate: The bit rate (in kbit/s or Mbit/s) is often referred to as speed, but actually defines the number of bits/time unit and not distance/time unit.

Enable H.264+ Mode: The H.264+ mode helps to ensure the high video quality with a lowered bitrate. It can effectively reduce the need of bandwidth and HDD storage space.



NOTE

A higher resolution, frame rate and bitrate setting will provide you the better video quality, but it will also require more internet bandwidth and use more storage space on the hard disk drive.

7.3.2 Sub-Stream

The sub-stream is a second codec that runs alongside the mainstream. It allows you to reduce the outgoing internet bandwidth without sacrificing your direct recording quality.

The sub-stream is often exclusively used by smartphone applications to view live video. Users with limited internet speeds may benefit most from this setting.

7.3.3 Picture

The picture refers to the live picture capture in continuous or event recording type.

Picture Quality: set the picture quality to low, medium or high. The higher picture quality results in more storage space requirement.

Interval: the interval of capturing live picture.

7.3.4 Configure Advanced Recording Settings

Step 1 Go to **Storage > Record Schedule**.

Step 2 Check **Enable Schedule** to enable scheduled recording.

Step 3 Click **Advanced** to set the recording parameters.



Figure 7-8 Advanced Record Settings

- **Record Audio:** Check the checkbox to enable or disable audio recording.
- **Pre-record:** The time you set to record before the scheduled time or event. For example, when an alarm triggers the recording at 10:00, and if you set the pre-record time as 5 seconds, the camera records at 9:59:55.
- **Post-record:** The time you set to record after the event or the scheduled time. For example, when an alarm triggered recording ends at 11:00, and if you set the post-record time as 5 seconds, it records till 11:00:05.
- **Expired Time:** The expired time is period for a recorded file to be kept in the HDD. When the deadline is reached, the file will be deleted. If you set the expired time to 0, the file will not be deleted. The actual keeping time for the file should be determined by the capacity of the HDD.
- **Redundant Record/Capture:** By enabling redundant record or capture you save the record and captured picture in the redundant HDD. See *Chapter Configure Redundant Recording and Capture*.
- **Stream Type:** Main stream and sub-stream are selectable for recording. When you select sub-stream, you can record for a longer time with the same storage space. For iDS-7200HQHI-K/S and iDS-7200HUHI-K/S series, the default value is dual stream, this value cannot be edited.

Step 4 Click **OK** to save the settings.

7.4 Configure Recording Schedule

Purpose:

Set the record schedule, and then the camera automatically starts/stops recording according to the configured schedule.

Before you start

Make sure you have installed the HDDs to the device or added the network disks before you storing the video files, pictures and log files.

Refer to the *Quick Start Guide* for the HDD installation.

Refer to *Chapter 7.1.2 Add the Network Disk* for network HDD connections.

Step 1 Go to **Storage > Recording Schedule**.

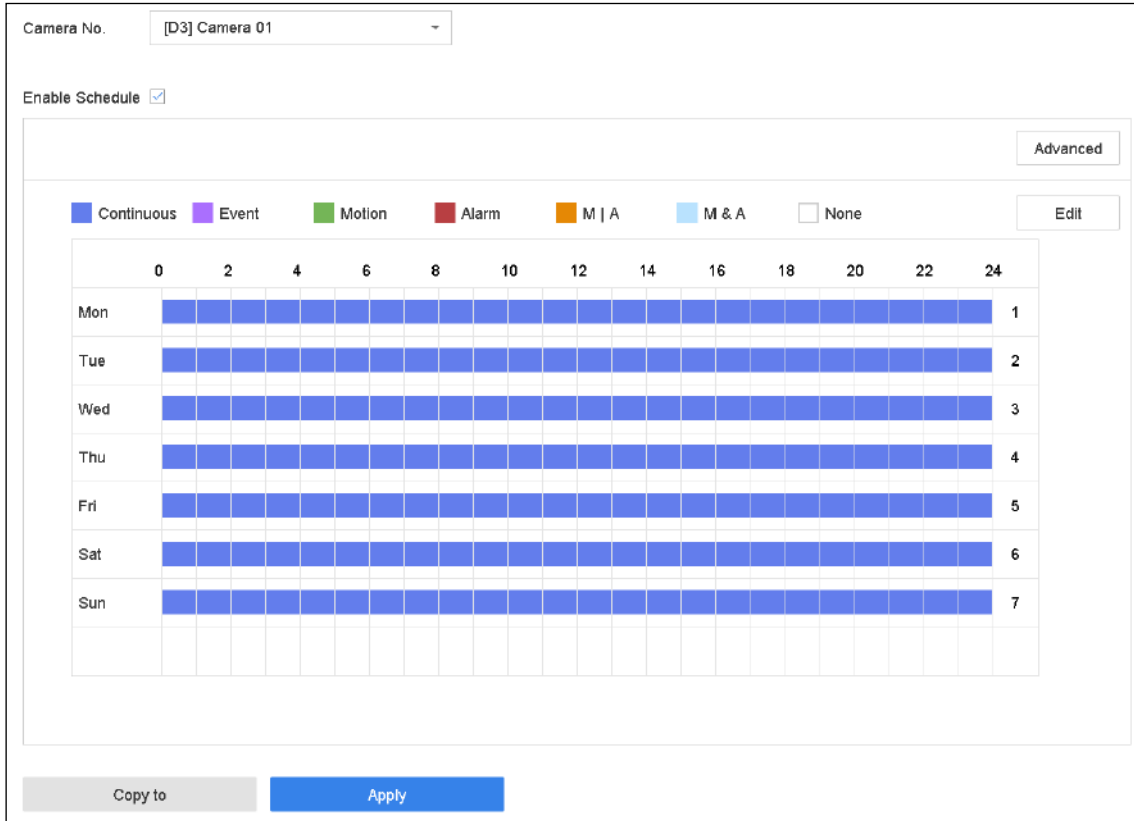

Figure 7-9 Recording Schedule

Step 2 Select a camera.

Step 3 Check **Enable Schedule**.

Step 4 Select a record type. The record type can be **Continuous, Motion Detection, Alarm, Motion | Alarm, Motion & Alarm**, and **Event**.

Different recording types are configurable.

Continuous: scheduled recording.

Event: recording triggered by all event triggered alarm.

Motion: recording triggered by motion detection.

Alarm: recording triggered by alarm.

M/A: recording triggered by either motion detection or alarm.

M&A: recording triggered by motion detection and alarm.

Step 5 Select a day and click-and-drag the mouse on the time bar to set the record schedule.

Step 6 Repeat the above steps to schedule recording or capture for other days in the week.



The all-day continuous recording is configured for the device by factory default.

Step 7 Click **Apply** to save the settings.



To enable Motion, Alarm, M | A (motion or alarm), M & A (motion and alarm) and Event triggered recording and capture, you must configure the motion detection settings, alarm input settings and other events as well. Please refer to Chapter 10 and 0for details.

7.5 Configure Continuous Recording

Step 1 Go to **Camera > Encoding Parameters > Recording Parameters**.

Step 2 Set the parameters for the camera.

Step 3 Go to **Storage > Recording Schedule**.

Step 4 Select the recording type to **Continuous**.

Step 5 Drag the mouse on the time bar to set the continuous recording schedule. Refer to Chapter 7.4 Configure Recording Schedule for details.

7.6 Configure Motion Detection Triggered Recording

Purpose:

You can configure the recording triggered by the motion detection event.

Step 1 Go to **System > Event > Normal Event > Motion Detection**.

Step 2 Configure the motion detection and select the channel (s) to trigger the recording when motion event occurs. Refer to 11.2 Configure Alarm Linkage Actions for details.

Step 3 Go to **Camera > Encoding Parameters > Recording Parameters**.

Step 4 Set the event main stream/sub-stream recording parameters for the camera.

Step 5 Go to **Storage > Recording Schedule**.

Step 6 Select the recording type to **Motion**.

Step 7 Drag the mouse on the time bar to set the motion detection recording schedule. Refer to Chapter 7.4 Configure Recording Schedule for details.

7.7 Configure Event Triggered Recording

Purpose:

You can configure the recording triggered by the motion detection, motion detection and alarm, face detection, vehicle detection, line crossing detection, etc.

Step 1 Go to **System > Event**.

Step 2 Configure the event detection and select the channel (s) to trigger the recording when event occurs. Refer to Chapter 11 Event and Alarm Settings and Chapter 13 VCA Event Alarm for details.

Step 3 Go to **Camera > Encoding Parameters > Recording Parameters**.

Step 4 Set the event main stream/sub-stream recording parameters for the camera.

Step 5 Go to **Storage > Recording Schedule**.

Step 6 Select the recording type to **Event**.

Step 7 Drag the mouse on the time bar to set the event detection recording schedule. Refer to Chapter 7.4 Configure Recording Schedule for details.

7.8 Configure Alarm Triggered Recording

Purpose:

You can configure the recording triggered by the motion detection, face detection, vehicle detection, line crossing detection, etc.

Step 1 Go to **System > Event > Normal Event > Alarm Input**.

Step 2 Configure the alarm input and select the channel (s) to trigger the recording when alarm occurs. Refer to Chapter 11 Event and Alarm Settings and Chapter 13 VCA Event Alarm for details.

Step 3 Go to **Camera > Encoding Parameters > Recording Parameters**.

Step 4 Set the event main stream/sub-stream recording parameters for the camera.

Step 5 Go to **Storage > Recording Schedule**.

Step 6 Select the recording type to **Alarm**

Step 7 Drag the mouse on the time bar to set the alarm recording schedule. Refer to Chapter 7.4 Configure Recording Schedule for details.

7.9 Configure Picture Capture

Purpose:

The picture refers to the live picture capture in continuous or event recording type.

Step 1 Go to **Camera > Encoding Parameters > Capture**.

Step 2 Set the picture parameters.

- **Resolution**: set the resolution of the picture to capture.
- **Picture Quality**: set the picture quality to low, medium or high. The higher picture quality results in more storage space requirement.
- **Interval**: the interval of capturing live picture.

Step 3 Go to **Storage > Capture Schedule**.

Step 4 Select the camera to configure the picture capture.

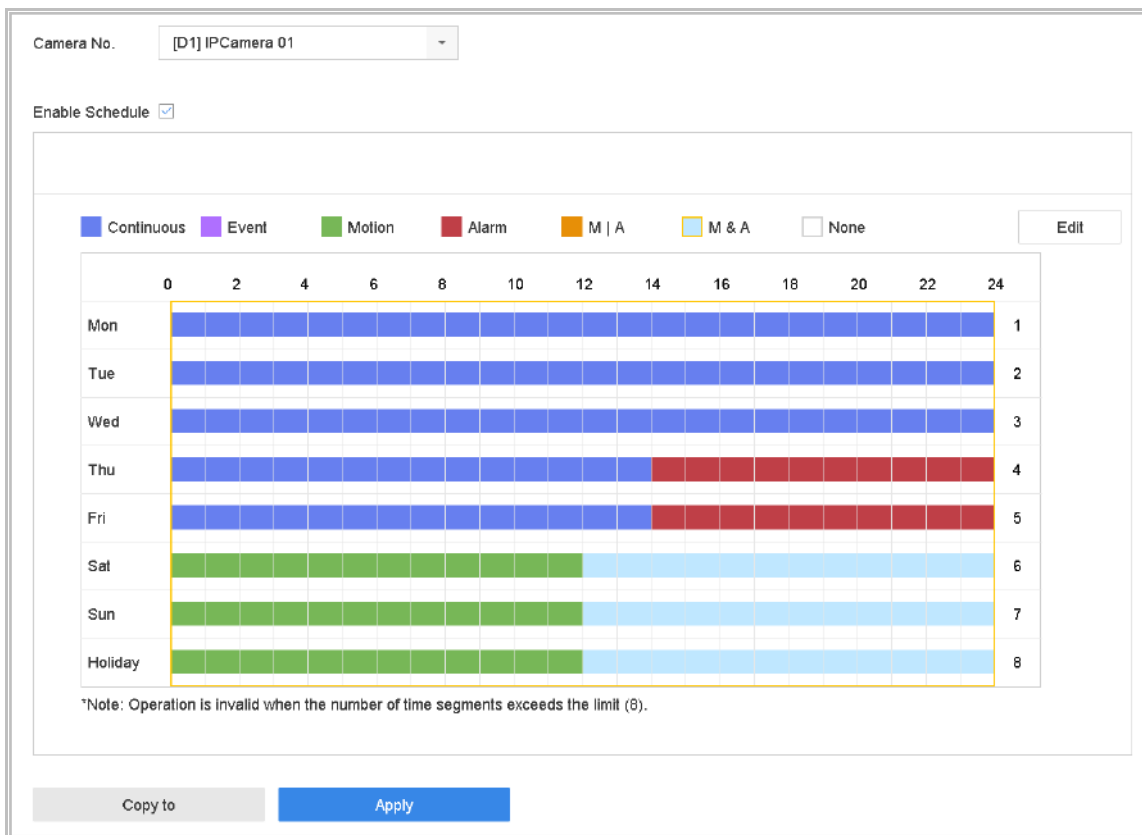

Figure 7-10 Set Picture Capture Schedule

Step 5 Set the picture capture schedule. Refer to Chapter 7.4 Configure Recording Schedule for details.

7.10 Configure Holiday Recording and Capture

Purpose:

Follow the steps to configure the record or capture schedule on holiday for that year. You may want to have different plan for recording and capture on holiday.

Step 1 Go to **System > Holiday**.

Step 2 Select a holiday item from the list and click .

Step 3 Check the **Enable** to configure the holiday.

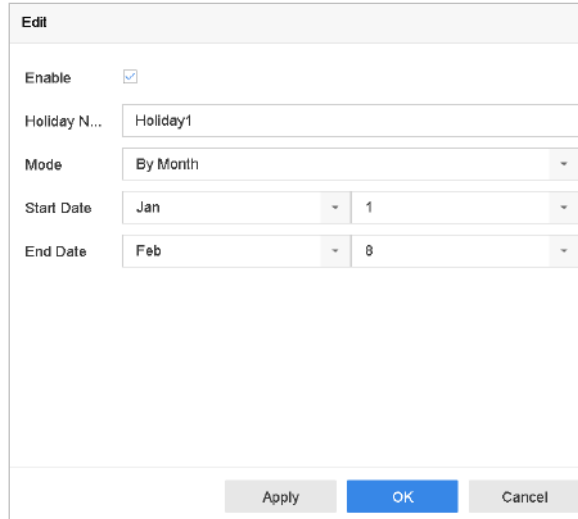

| | |
|-----------------|-------------------------------------|
| Edit | |
| Enable | <input checked="" type="checkbox"/> |
| Holiday N... | Holiday1 |
| Mode | By Month |
| Start Date | Jan 1 |
| End Date | Feb 8 |
| Apply OK Cancel | |

Figure 7-11 Edit Holiday Settings

- 1) Edit the holiday name.
- 2) Select the mode to by date, by week or by month.
- 3) Set the start and end date of the holiday.
- 4) Click **OK**.

Step 4 Set the schedule for the holiday recording. Refer to Chapter 7.4 Configure Recording Schedule for details.

7.11 Configure Redundant Recording and Capture

Purpose:

Enabling redundant recording and capture, which means saving the record files and captured pictures not only in the R/W HDD but also in the redundant HDD, will effectively enhance the data safety and reliability.



You must set the storage mode to *Group* before you set the HDD property to Redundancy. For detailed information, please refer to Chapter 7.2.1 Configure HDD Group. There should be at least another HDD which is in Read/Write status.

Step 1 Go to **Storage > Storage Device**.

Step 2 Select a **HDD** from the list and Click  to enter the Local HDD Settings interface.

Step 3 Set the HDD property to **Redundancy**.

Figure 7-12 HDD Property-Redundancy

Step 4 Go to **Storage > Schedule Settings > Record Schedule/Capture Schedule**.

Step 5 Click **Advanced** to set the camera recording parameters.

The screenshot shows a dialog box titled "Advanced Parameters" with the following settings:

- Record Audio:
- Pre-Record: 5s (dropdown menu)
- Post-Record: 5s (dropdown menu)
- Stream Type: Main Stream (dropdown menu)
- Expired Time (day): 5 (text input)
- Redundant Record/Capture

At the bottom of the dialog are two buttons: "OK" (blue) and "Cancel" (grey).

Figure 7-13 Record Parameters

Step 6 Check the checkbox of **Redundant Record/Capture**.

Step 7 Click **OK** to save settings.

7.12 Configure 1080p Lite

Purpose

When the 1080P Lite Mode is enabled, the encoding resolution at 1080P Lite (real-time) is supported. If not, up to 1080P (non-real-time) is supported.



This chapter is applicable to HQHI series DVR.

7.12.1 Enable the 1080P Lite Mode

Step 1 Go to **Menu > Record > Advanced**.

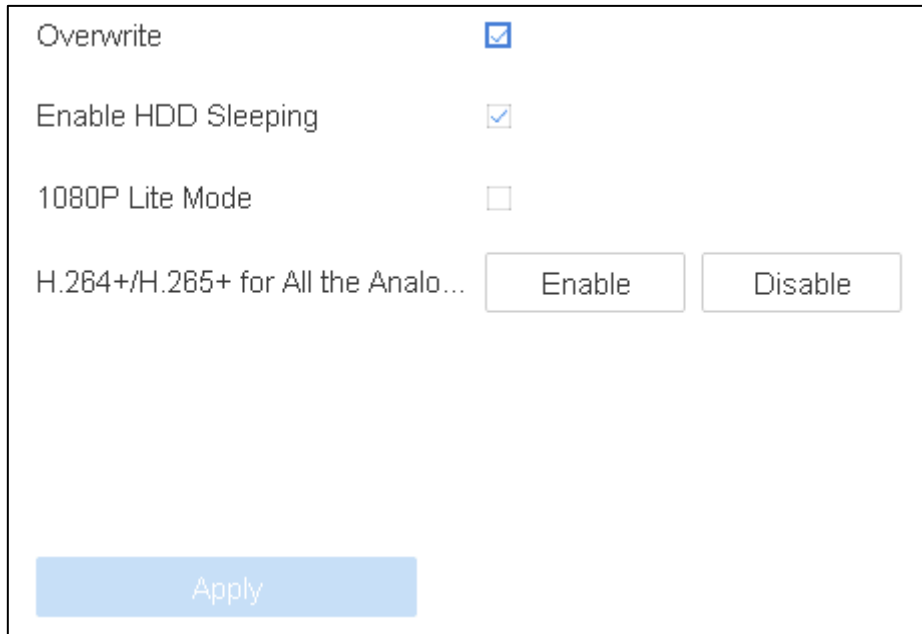

Figure 7-14 Advanced Interface

Step 2 Check the checkbox of **1080P Lite Mode** and click **Apply** to pop up the attention box. After enabling 1080p lite mode, the 3 MP signal is not accessible to analog channel.

Step 3 Click **Yes** in popup message box to reboot the device to have new settings taken effect.

7.12.2 Disable the 1080P Lite Mode

Step 1 Go to **Menu > Record > Advanced**.

Step 2 Uncheck the checkbox of **1080P Lite Mode** and click **Apply**. The following attention box pops up.

Step 3 Click **Yes** in popup message box to reboot the device to activate the new settings or **No** to restore the old settings.

Chapter 8 Disk Array



This chapter is applicable for DS-7300/8100/9000HUHI-K and DS-7300/8100/9000HTHI-K series DVR.

Purpose:

Disk array is a data storage virtualization technology that combines multiple physical disk drive components into a single logical unit. An array stores data over multiple HDDs to provide enough redundancy so that data can be recovered if one disk fails. Data is distributed across the drives in one of several ways called "RAID levels", depending on what level of redundancy and performance is required.

8.1 Create Disk Array

Purpose:

The device supports the disk array that is realized by software. You can enable the RAID function as required. Two ways are available for creating array: one-touch configuration and manual configuration. The following flow chart shows the process of creating array.

8.1.1 Enable RAID

Purpose:

Perform the following steps to enable the disk array function.

Step 1 Go to **Storage > Advanced**.

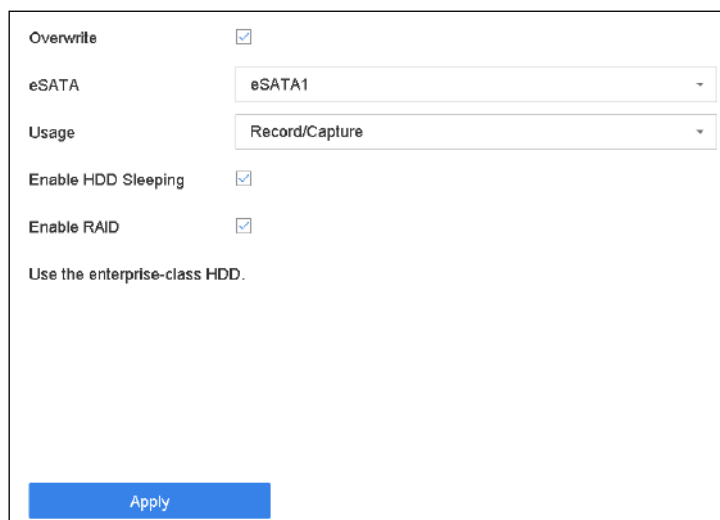

Figure 8-1 Advanced

Step 2 Check **Enable RAID**.

Step 3 Click **Apply**.

Step 4 Reboot device to take effect the settings.

8.1.2 One-Touch Creation

Purpose:

One-touch configuration helps you to quickly create the disk array. By default, the array type created by one-touch configuration is RAID 5.

Before you start:

- Enable RAID function. For details, refer to Chapter 8.1.1 Enable RAID.
- Install at least 3 HDDs. If more than 10 HDDs are installed, 2 arrays will be created. To maintain reliable and stable running of the HDDs, it is recommended to use enterprise-level HDDs with the same model and capacity.

Step 1 Go to **Storage > RAID Setup > Physical Disk**.

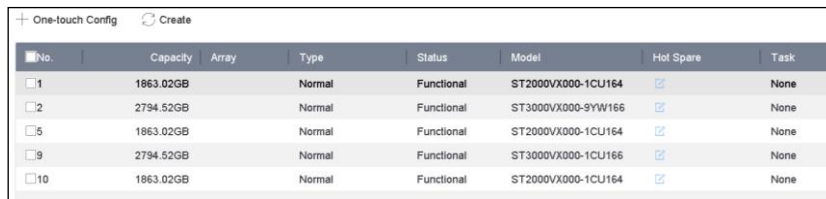

| No. | Capacity | Array | Type | Status | Model | Hot Spare | Task |
|-----------------------------|-----------|-------|--------|------------|--------------------|--------------------------|------|
| <input type="checkbox"/> 1 | 1863.02GB | | Normal | Functional | ST2000VX000-1CU164 | <input type="checkbox"/> | None |
| <input type="checkbox"/> 2 | 2734.52GB | | Normal | Functional | ST3000VX000-9YW166 | <input type="checkbox"/> | None |
| <input type="checkbox"/> 5 | 1863.02GB | | Normal | Functional | ST2000VX000-1CU164 | <input type="checkbox"/> | None |
| <input type="checkbox"/> 9 | 2734.52GB | | Normal | Functional | ST3000VX000-1CU166 | <input type="checkbox"/> | None |
| <input type="checkbox"/> 10 | 1863.02GB | | Normal | Functional | ST2000VX000-1CU164 | <input type="checkbox"/> | None |

Figure 8-2 Physical Disk

Step 2 Click **One-touch Config**.

Step 3 Edit the array name in **Array Name** text filed and click **OK** to start configuring.

NOTE

If you install 4 HDDs or more, a hot spare disk for array rebuilding will be created.

Step 4 A message box will pop up when the array creation is completed, click **OK** on it.

Step 5 Optionally, the device will automatically initialize the created array. Go to **Storage > RAID Setup > Array** view the information of created array.

8.1.3 Manual Creation

Purpose:

Manually create the array of RAID 0, RAID 1, RAID 5, RAID 6, and RAID 10.

Step 1 Go to **Storage > RAID Setup > Physical Disk**.

Step 2 Click **Create**.

Table 8-1 Create Array

Step 3 Enter the array name.

Step 4 Select **RAID Level** as **RAID 0**, **RAID 1**, **RAID 5**, **RAID 6**, or **RAID 10** as required.

Step 5 Select the physical disks to constitute array.

Table 8-2 Required Number of HDD

| RAID Level | Required Number of HDD |
|------------|--|
| RAID 0 | At least 2 HDDs. |
| RAID 1 | At least 2 HDDs. |
| RAID 5 | At least 3 HDDs. |
| RAID 6 | At least 4 HDDs. |
| RAID 10 | The number of HDD must be an even ranges from 4 to 16. |

Step 6 Click **OK**.

Step 7 Optionally, the device will automatically initialize the created array. Go to **Storage > RAID Setup > Array** view the information of created array.

| No | Name | Free Space | Physical Disk | Hot S... | Status | Level | Rebuild | Delete | Task |
|----|---------|------------|---------------|----------|------------|--------|---------|--------|--------------------------------|
| 1 | Array01 | 3725/3725G | 1 5 10 | | Functional | RAID 5 | | | Initialize (Fast)(Running) 43% |

Figure 8-3 Array List

8.2 Rebuild Array

Purpose:

The status of array includes Functional, Degraded and Offline. To ensure the high security and reliability of the data stored in array, you should take immediate and proper maintenance at arrays according their status.

- Functional: No disk loss in the array.
- Offline: The number of lost disks has exceeded the limit.
- Degraded: If amount of HDD fail in array, array degrades. You should recover it to Functional by array rebuilding.

8.2.1 Configure Hot Spare Disk

Purpose:

Hot spare disks are required for disk array automatic rebuilding.

Step 1 Go to **Storage > RAID Setup > Physical Disk**.

| No. | Capacity | Array | Type | Status | Model | Hot Spare | Task |
|----------------------------|-----------|---------|--------|------------|--------------------|-----------|------|
| 1 | 1863.02GB | Array01 | Array | Functional | ST2000VX000-1CU164 | - | None |
| <input type="checkbox"/> 2 | 2794.52GB | | Normal | Functional | ST3000VX000-9YW166 | | None |
| 5 | 1863.02GB | Array01 | Array | Functional | ST2000VX000-1CU164 | - | None |
| <input type="checkbox"/> 9 | 2794.52GB | | Normal | Functional | ST3000VX000-1CU166 | | None |
| 10 | 1863.02GB | Array01 | Array | Functional | ST2000VX000-1CU164 | - | None |

Figure 8-4 Physical Disk

Step 2 Click of an available HDD to set it as the hot spare disk.

8.2.2 Automatically Rebuild Array

Purpose:

The device can automatically rebuild degraded arrays with the hot spare disks.

Before you start:

Create hot spare disks. For details, refer to Chapter 8.2.1 Configure Hot Spare Disk.

Step 1 The device will automatically rebuild the degraded arrays with the hot spare disks. Go to **Storage > RAID Setup > Array** to view rebuilding progress.

| No. | Name | Free Space | Physical Disk | Hot Spare | Status | Level | Rebuild | Delete | Task |
|-----|---------|------------|---------------|-----------|----------|--------|---------|--------|---------------------|
| 1 | Array01 | 3725/3725G | 2 5 10 | | Degraded | RAID 5 | | | Rebuild(Running) 0% |
| | | | | | | | | | |
| | | | | | | | | | |

Figure 8-5 Array List

8.2.3 Manually Rebuild Array

Purpose:

If no hot spare disks are configured, rebuild the degraded array manually.

Before you start:

At least one available physical disk should exist for rebuilding the array.

Step 1 Go to **Storage > RAID Setup > Array**.

| No. | Name | Free Space | Physical Disk | Hot Spare | Status | Level | Rebuild | Delete | Task |
|-----|---------|------------|---------------|-----------|----------|--------|---------|--------|------|
| 1 | Array01 | 3725/3725G | 5 10 | | Degraded | RAID 5 | | | None |

Figure 8-6 Array List

Step 2 Click of degraded array.

Rebuild Array

Array Name:

RAID Level:

Array Disk:

Physical Disk: 2 9

Figure 8-7 Rebuild Array

Step 3 Select the available physical disk.

Step 4 Click **OK**.

Step 5 Click **OK** on the pop up message box “Do not unplug the physical disk when it is under rebuilding”.

8.3 Delete Array



Deleting array will delete all the data saved in it.

Step 1 Go to **Storage > RAID Setup > Array.**

| No. | Name | Free Space | Physical Disk | Hot Spare | Status | Level | Rebuild | Delete | Task |
|-----|---------|------------|---------------|-----------|----------|--------|---------|--------|------|
| 1 | Array01 | 3725/3725G | 5 10 | | Degraded | RAID 5 | | | None |
| | | | | | | | | | |
| | | | | | | | | | |

Figure 8-8 Array List

Step 2 Click of array to delete.

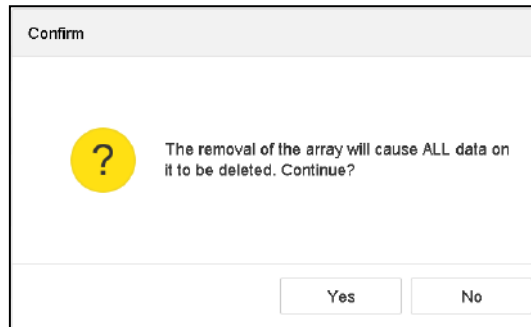

Figure 8-9 Attention

Step 3 Click **Yes** on the popup message box.

8.4 Check and Edit Firmware

Purpose:

You can view the information of the firmware and set the background task speed on the Firmware interface.

Step 1 Go to **Storage > RAID Setup > Firmware.**

| | |
|-----------------------|------------------|
| Version | 1.1.0.0003 |
| Physical Disk Count | 16 |
| Array Count | 16 |
| Virtual Disk Count | 0 |
| RAID Level | 0 1 5 6 10 |
| Hot Spare Type | Global Hot Spare |
| Support Rebuild | Yes |
| Background Task Speed | Medium Speed |

Figure 8-10 Firmware

Step 2 Optionally, set the **Background Task Speed.**

Step 3 Click **Apply.**

Chapter 9 File Management

9.1 Search and Export All Files

9.1.1 Search Files

Purpose

Specify detailed conditions to search videos and pictures.

Step 1 Go to **File Management > All Files**.

Step 2 Specify detailed conditions, including time, camera, event type, etc.

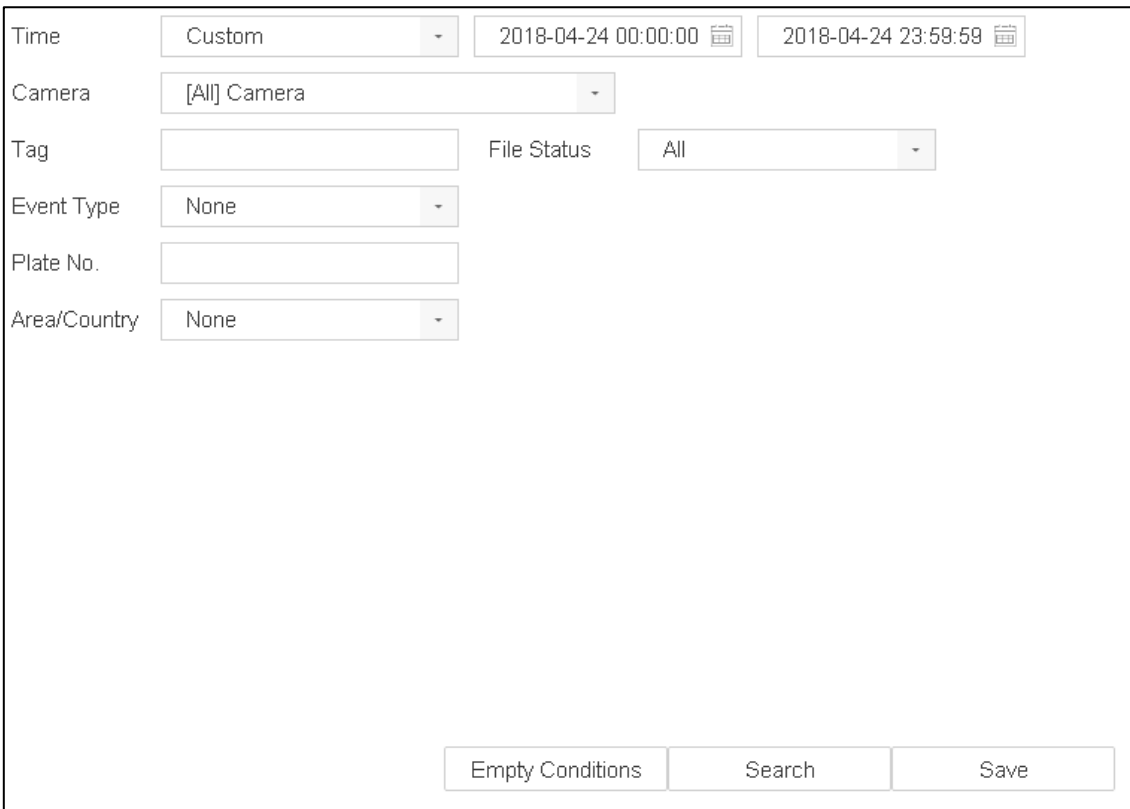

The screenshot shows a search configuration interface with the following fields and controls:

- Time:** A dropdown menu set to "Custom", followed by two date-time pickers. The first is "2018-04-24 00:00:00" and the second is "2018-04-24 23:59:59".
- Camera:** A dropdown menu set to "[All] Camera".
- Tag:** An empty text input field.
- File Status:** A dropdown menu set to "All".
- Event Type:** A dropdown menu set to "None".
- Plate No.:** An empty text input field.
- Area/Country:** A dropdown menu set to "None".

At the bottom of the form, there are three buttons: "Empty Conditions", "Search", and "Save".

Figure 9-1 Search All Files

Step 3 Click **Search** to display results. The matched files will be displayed.

9.1.2 Export Files

Purpose

Export files for backup purposes using USB device (USB flash drive, USB HDD, USB optical disc drive), SATA optical disc drive or eSATA HDD.

Step 1 Search files to export. For details, see *9.1.1 Search Files*.

Step 2 Click to select files and click **Export**.

Step 3 Select the file to export as **Video and Log** and click **OK**.

Step 4 Click **OK** to export files to backup device.

9.2 Search and Export Human Files

9.2.1 Search Human Files

Purpose

Specify detailed conditions to search human pictures and videos.

Before you start

Configure human body detection function for the cameras you want to search and export human pictures and videos.

Step 1 Go to **File Management > Human Files**.

Step 2 Select **Time** and **Camera** to search.

Figure 9-2 Search Human Files

Step 3 Click **Search** to display results. The matched files are displayed in thumbnail or list.

Step 4 Select **Target Picture** or **Source Picture** in menu bar to display related pictures only.

- **Target Picture:** Display the search results of people close-up.
- **Source Picture:** Display the search results of original picture captured by camera.

9.2.2 Export Human Files

Purpose

Export files for backup purposes using USB device (USB flash drive, USB HDD, USB optical disc drive), SATA optical disc drive or eSATA HDD.

Step 1 Search for the human files to export. For details, see *9.2.1 Search Human Files*.

Step 2 Click to select files and click **Export**.

Step 3 Select the file to export as **Video and Log** and click **OK**.

Step 4 Click **OK** to export files to backup device.

9.3 Search and Export Vehicle Files

9.3.1 Search Vehicle Files

Purpose

Specify detailed conditions to search vehicle pictures and videos.

Before you start

Configure vehicle detection function for the cameras you want to search and export vehicle pictures and videos.

Step 1 Go to **File Management > Vehicle Files**.

Step 2 Specify detailed conditions, including **Time**, **Camera**, **Plate No.**, and **Area/Country**.

The screenshot shows a search configuration form with the following elements:

- Time:** A dropdown menu set to "Custom" and two date-time pickers showing "2017-10-24 00:00:00" and "2017-10-24 23:59:59".
- Camera:** A dropdown menu set to "[All] Camera".
- Plate No.:** An empty text input field.
- Area/Country:** A dropdown menu set to "None".
- Buttons:** "Empty Conditions", "Search", and "Save" are located at the bottom right of the form.

Figure 9-3 Search Vehicle Files

Step 3 Click **Search** to display results. The matched files are displayed in thumbnail or list.

Step 4 Select **Target Picture** or **Source Picture** in menu bar to display related pictures only. Select **Video** or **Picture** to specify the file type.

- **Target Picture:** Display the search results of vehicle close-up.
- **Source Picture:** Display the search results of original picture captured by camera.

9.3.2 Export Vehicle Files

Purpose

Export files for backup purposes using USB device (USB flash drive, USB HDD, USB optical disc drive), SATA optical disc drive or eSATA HDD.

Step 1 Search for the vehicle files to export. For details, see *9.3.1 Search Vehicle Files*.

Step 2 Click to select files and click **Export**.

Step 3 Select the file to export as **Video and Log** and click **OK**.

Step 4 Click **OK** to export files to backup device.

9.4 Search History Operation

9.4.1 Save Search Condition

Purpose

You can save the search conditions for future reference and quick search.

Step 1 Go to **File Management > All Files/People Appearance File/Vehicle File**.

Step 2 Set the search conditions.

Step 3 Click **Save**.

Step 4 Enter a name in text field and click **Finished**. The saved search conditions will be displayed in **Search Condition**.

9.4.2 Call Search History

Purpose:

You can quickly search files by calling search history.

Step 1 Go to **File Management > All Files/Human Files/Vehicle Files**.

Step 2 Click a search condition in **Search Condition** to quickly search files.

Chapter 10 Playback

10.1 Play Video Files

10.1.1 Instant Playback

Purpose:

Instant Playback enables the device to play the recorded video files in last five minutes. If no video is found, it means there is no recording during the last five minutes.

Step 1 On the live view window of the selected camera, move the cursor to the window bottom to access the toolbar.

Step 2 Click  to start instant playback.



Figure 10-1 Playback Interface

10.1.2 Play Normal Video

Purpose:

In the normal playback mode, you can achieve the advanced playback operations which will satisfy more complicated requirements.

Step 1 Go to **Playback**.

Step 2 Select one or more cameras in the **Channel** list to start playing the video.

Step 3 Select a date in the calendar.

- Use the toolbar in the bottom part of playback interface to control the playing and realize a series of operations. Refer to Chapter 10.2 Playback Operations.



Figure 10-2 Playback Interface

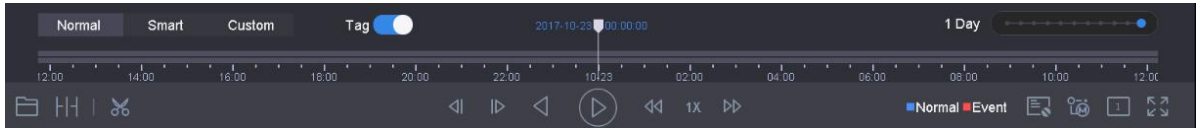

Figure 10-3 Toolbar of Playback

- Click the channel(s) to execute simultaneous playback of multiple channels.

NOTE

- The playing speed of 256X is supported.
- HGHI-K series do not support play reverse of smart stream.

10.1.3 Play Smart Searched Video

Purpose:

In the smart playback mode, the device can analyze the video containing the motion, line or intrusion detection information, mark it in red color and play the smart searched video.

NOTE

The smart playback must be in the single-channel playing mode.

Step 1 Go to **Playback**.

Step 2 Start playing the video of camera.

Step 3 Click **Smart**.

Step 4 From the toolbar at the bottom of the playing window, click the motion/line crossing/ intrusion icon for search.



Figure 10-4 Playback by Smart Search

Step 5 Set the rules and areas for smart search of line crossing detection, intrusion detection or motion detection event triggered recording.



- **Line Crossing Detection**

- 5) Click the  icon.
- 6) Click on the image to specify the start point and end point of the line.

- **Intrusion Detection**

- 7) Click the  icon.
- 8) Specify 4 points to set a quadrilateral region for intrusion detection. Only one region can be set.

- **Motion Detection**

- 9) Click the  icon.
- 10) Hold the mouse on the image to draw the detection area manually.
- 11) Click Search  to search the matched video and start to play it.

10.1.4 Play Custom Searched Files

Purpose:

You can play the files by custom search with different conditions.

Step 1 Go to **Playback**.

Step 2 Select a camera or cameras from the list.

Step 3 Click **Custom Search** on the left bottom to enter the **Search Condition** interface.

Step 4 Enter the search conditions for the files, e.g., time, file status, event type, etc.

| | | | |
|--------------|--------|---------------------|---------------------|
| Time | Custom | 2017-10-01 00:00:00 | 2017-10-23 23:59:59 |
| Tag | A | File Status | All |
| Event Type | None | | |
| Plate No. | | | |
| Area/Country | None | | |

| | | |
|------------------|--------|------|
| Empty Conditions | Search | Save |
|------------------|--------|------|

Figure 10-5 Custom Search

Step 5 Click **Search**.

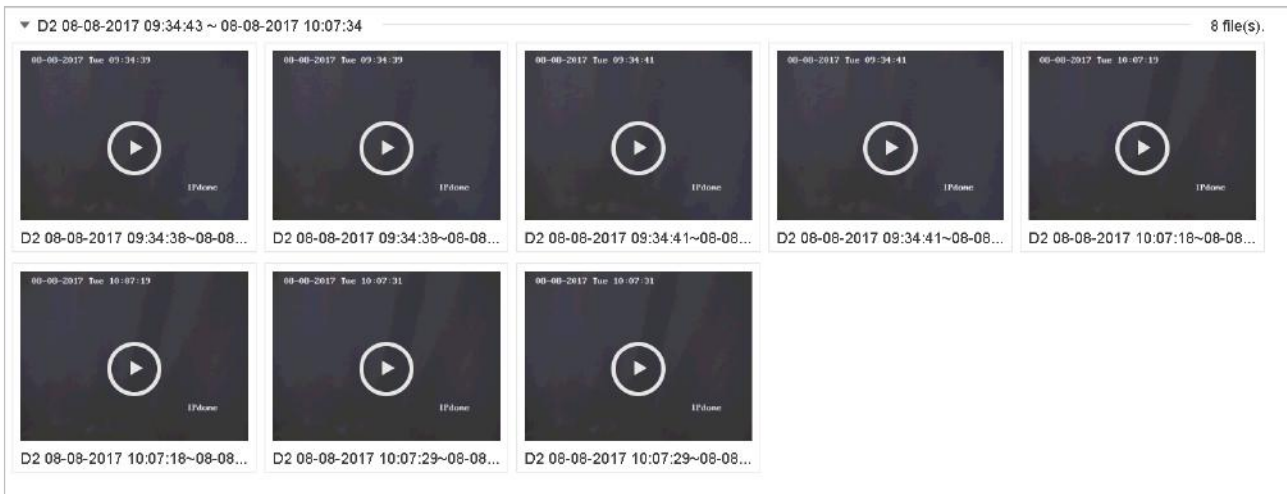

Figure 10-6 Custom Searched Video Files

Step 6 On the search results interface, select a file and click to start playing the video.

10.1.5 Play Tag Files

Purpose:

Video tag allows you to record related information like people and location of a certain time point during playback. You can use video tag(s) to search for video files and position time point.

Before playing back by tag:

Add Tag Files

Step 1 Go to **Playback**.

Step 2 Search and play back the video file(s).

Step 3 Click  to add the tag.

Step 4 Edit the tag information.

Step 5 Click **OK**.



Max. 64 tags can be added to a single video file.

Edit Tag Files

Step 1 Go to Playback.

Step 2 Click **Tag**.

The available tags are white marked and displayed in the time bar.

Step 3 Point the white marked tag in the time bar to access the tag information.

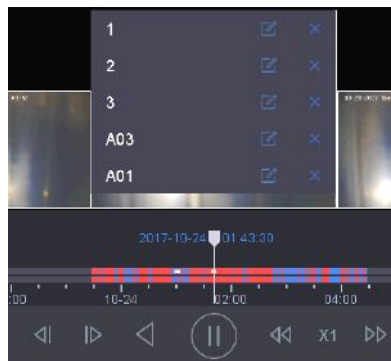



Figure 10-7 Edit Tag Files

Step 4 Click  to edit the tag name.

Step 5 Click **OK**.

Play Tag Files

Step 1 Go to **Playback**.

Step 2 Click **Custom Search** on the left bottom to enter the Search Condition interface.

Step 3 Enter the search conditions for the tag files, including the time and the tag keyword.

The screenshot shows a search interface with the following fields and values:

- Time: Custom, 2017-10-01 00:00:00, 2017-10-23 23:59:59
- Tag: A
- File Status: All
- Event Type: None
- Plate No.: (empty)
- Area/Country: None

Buttons at the bottom: Empty Conditions, Search, Save

Figure 10-8 Tag Search

Step 4 Click **Search**.

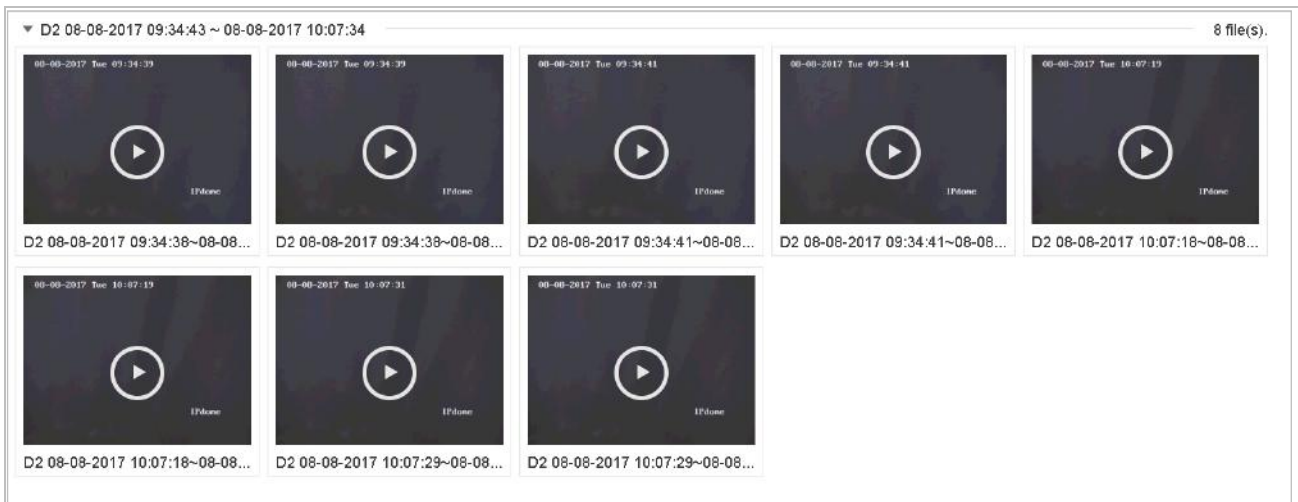

Figure 10-9 Searched Tag Files

Step 5 On the search results interface, select a tag file and click to start playing the video.

10.1.6 Play Event Files

Purpose

Play back video files on one or several channels searched by event type (e.g., alarm input, motion detection, line crossing detection, face detection, vehicle detection, etc.).

Step 1 Go to **Playback**.

Step 2 Click **Custom Search** on the left bottom to enter the Search Condition interface.

Step 3 Enter the search conditions for the event files, e.g., time, event type, file status, vehicle information (for vehicle detection event), etc.

Step 4 Click **Search**.

Step 5 On the search results interface, select an event video file/picture file and double click to start playing the video.

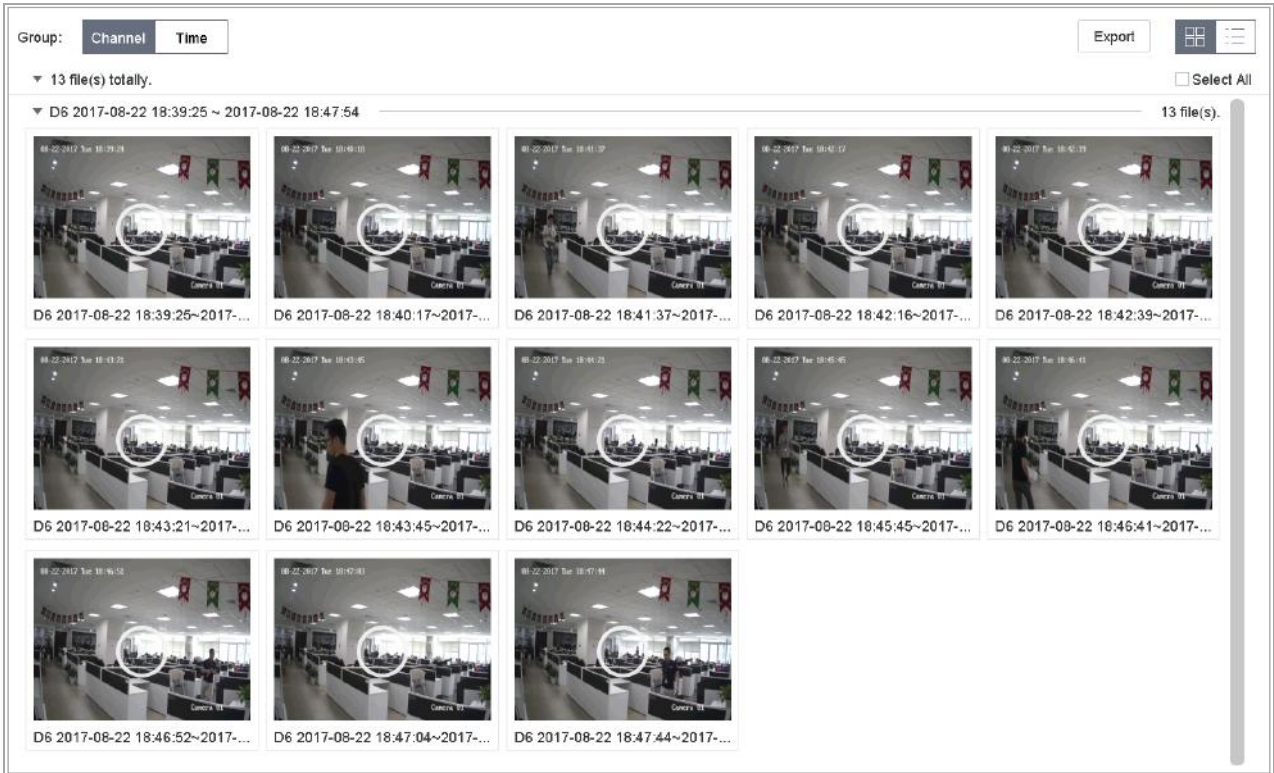



Figure 10-10 Event Files

Step 6 You can click  or  button to play 30s backward or forward.

 **NOTE**

- Refer to Chapter 11 Event and Alarm Settings and Chapter 13 VCA Event Alarm for details for event and alarm settings.
- Refer to Chapter 7.7 Configure Event Triggered Recording for the event triggered recording/capture settings.

10.1.7 Play by Sub-periods

Purpose:

The video files can be played in multiple sub-periods simultaneously on the screens.

Step 1 Go to **Playback**.

Step 2 Select  icon at the left bottom corner to enter the sub-period playing mode.

Step 3 Select a camera.

Step 4 Set the start time and end time for searching video.

Step 5 Select the different multi-period at the right bottom corner, e.g., 4-Period.

 **NOTE**

According to the defined number of split-screens, the video files on the selected date can be divided into average segments for playback. E.g., if there are video files existing between 16:00 and 22:00, and the 6-screen display mode is selected, then it can play the video files for 1 hour on each screen simultaneously.

10.1.8 Play Log Files

Purpose:

Play back record file(s) associated with channels after searching system logs.

Step 1 Go to **Maintenance>Log Information**.

Step 2 Click **Log Search** tab to enter Playback by System Logs.

Step 3 Set search time and type and click **Search**.

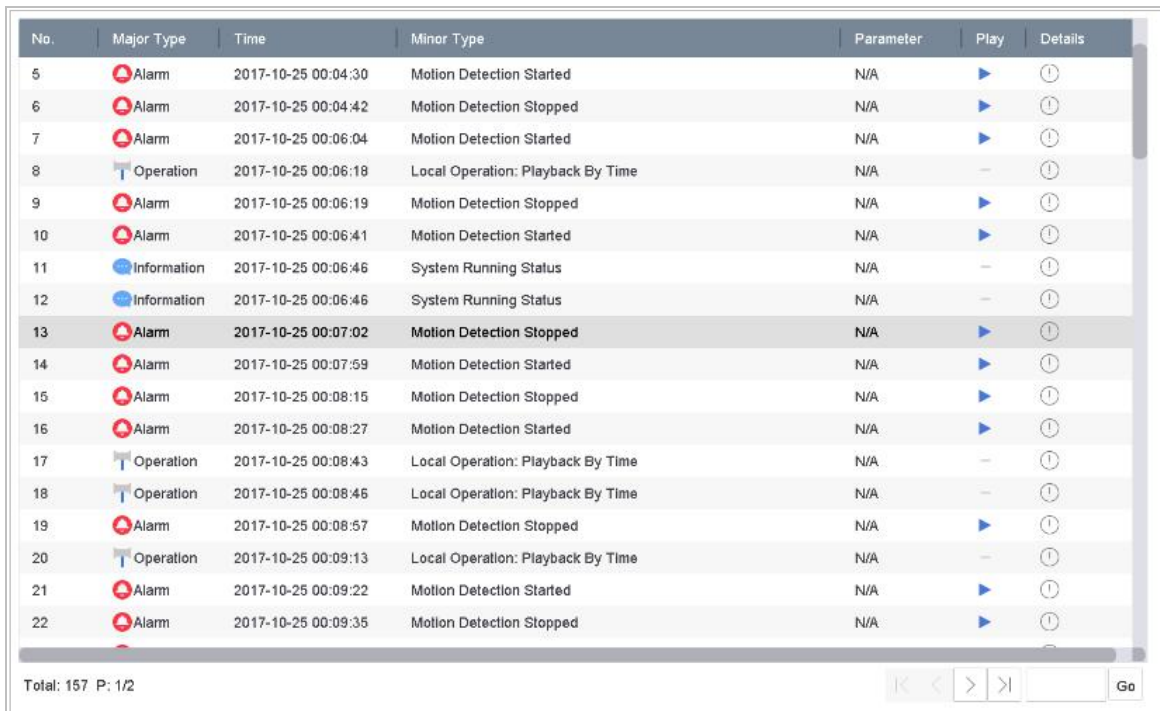

| No. | Major Type | Time | Minor Type | Parameter | Play | Details |
|-----|-------------|---------------------|-----------------------------------|-----------|------|---------|
| 5 | Alarm | 2017-10-25 00:04:30 | Motion Detection Started | N/A | ▶ | ⓘ |
| 6 | Alarm | 2017-10-25 00:04:42 | Motion Detection Stopped | N/A | ▶ | ⓘ |
| 7 | Alarm | 2017-10-25 00:06:04 | Motion Detection Started | N/A | ▶ | ⓘ |
| 8 | Operation | 2017-10-25 00:06:18 | Local Operation: Playback By Time | N/A | — | ⓘ |
| 9 | Alarm | 2017-10-25 00:06:19 | Motion Detection Stopped | N/A | ▶ | ⓘ |
| 10 | Alarm | 2017-10-25 00:06:41 | Motion Detection Started | N/A | ▶ | ⓘ |
| 11 | Information | 2017-10-25 00:06:46 | System Running Status | N/A | — | ⓘ |
| 12 | Information | 2017-10-25 00:06:46 | System Running Status | N/A | — | ⓘ |
| 13 | Alarm | 2017-10-25 00:07:02 | Motion Detection Stopped | N/A | ▶ | ⓘ |
| 14 | Alarm | 2017-10-25 00:07:59 | Motion Detection Started | N/A | ▶ | ⓘ |
| 15 | Alarm | 2017-10-25 00:08:15 | Motion Detection Stopped | N/A | ▶ | ⓘ |
| 16 | Alarm | 2017-10-25 00:08:27 | Motion Detection Started | N/A | ▶ | ⓘ |
| 17 | Operation | 2017-10-25 00:08:43 | Local Operation: Playback By Time | N/A | — | ⓘ |
| 18 | Operation | 2017-10-25 00:08:46 | Local Operation: Playback By Time | N/A | — | ⓘ |
| 19 | Alarm | 2017-10-25 00:08:57 | Motion Detection Stopped | N/A | ▶ | ⓘ |
| 20 | Operation | 2017-10-25 00:09:13 | Local Operation: Playback By Time | N/A | — | ⓘ |
| 21 | Alarm | 2017-10-25 00:09:22 | Motion Detection Started | N/A | ▶ | ⓘ |
| 22 | Alarm | 2017-10-25 00:09:35 | Motion Detection Stopped | N/A | ▶ | ⓘ |

Total: 157 P: 1/2

Figure 10-11 System Log Search Interface

Step 4 Choose a log with video file and click  to start playing the log file.

10.1.9 Play External File

Purpose:

You can play files from the external storage devices.

Before You Start:

Connect the storage device with the video files to your device.

Step 1 Go to **Playback**.

Step 2 Click the  icon at the left bottom corner.

Step 3 Select and click the  button or double click to play the file.

10.2 Playback Operations

10.2.1 Set Play Strategy in Smart/Custom Mode

Purpose:

When you are in the smart or custom video playback mode, you can set the playing speed separately for the normal video and the smart/custom video, or you can select to skip the normal video.

In the Smart/Custom video playback mode, click  to set the play strategy.

- When **Do not Play Normal Videos** is checked, the device will skip the normal video and play the smart (motion/line crossing/intrusion) video and the custom (searched video) only in the normal speed (X1).
- When **Do not Play Normal Videos** is unchecked, you can set the play speed for the normal video the smart/custom video separately. The speed range is from X1 to XMAX.

 **NOTE**

You can set the speed in the single-channel play mode only.

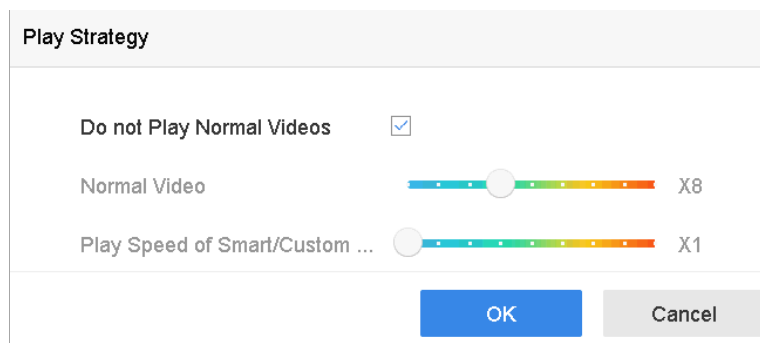



Figure 10-12 Play Strategy

10.2.2 Edit Video Clips

You can take video clips during the playback and export the clips.

In the video playback mode, click  to start video clipping operation.

- : Set the start time and end time of the video clipping.
- : Export the video clips to the local storage device.

10.2.3 Switch between Main Stream and Sub-Stream

You can switch between the main stream and the sub-stream during the playback (except iDS-7200HQHI-K/S, iDS-7200HUHI-K/S, DS-7200HGHI-K1 and DS-7200HGHI-K2 series).



: Play the video in main stream.



: Play the video in sub-stream.

10.2.4 Thumbnails View

With the thumbnails view on the playback interface, you can conveniently locate the required video files on the time bar.

In the video playback mode, move the mouse to the time bar to get the preview thumbnails of the video files.

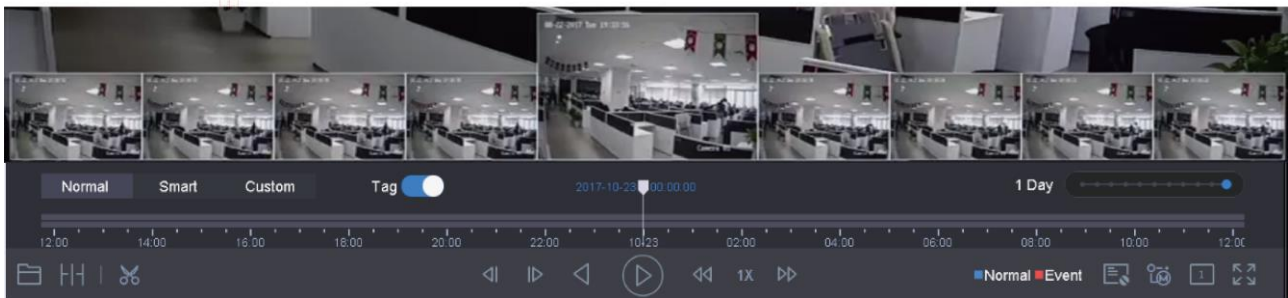

Figure 10-13 Thumbnails View

You can select and click on a required thumbnail to enter the full-screen playback.

NOTE

iDS-7200HQHI-K/S, iDS-7200HUHI-K/S, HGHI, HQHI, DS-7200HUHI-K and DS-7200HTHI-K series don't support this function.

10.2.5 Fast View

You can hold the mouse to drag on the time bar to get the fast view of the video files.

In the video playback mode, use the mouse to hold and drag through the playing time bar to fast view the video files.

Release the mouse to the required time point to enter the full-screen playback.

10.2.6 Digital Zoom

In the video playback mode, click  from the toolbar to enter the digital zoom interface.

You can move the sliding bar or scroll the mouse wheel to zoom in/out the image to different proportions (1 to 16X).



Figure 10-14 Digital Zoom

Chapter 11 Event and Alarm Settings

11.1 Configure Arming Schedule

Step 1 Select the **Arming Schedule** tab.

Step 2 Choose one day of a week and set the time segment. Up to eight time periods can be set within each day.



Time periods shall not be repeated or overlapped.

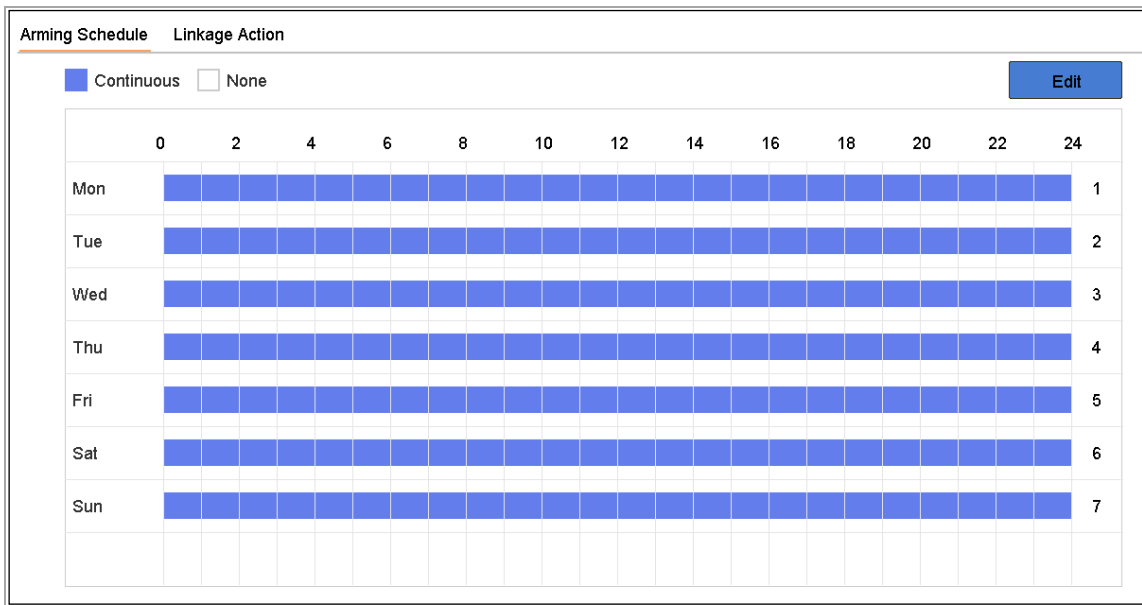

Figure 11-1 Set Arming Schedule

Step 3 Click **Apply** to save the settings.

11.2 Configure Alarm Linkage Actions

Purpose:

Alarm linkage actions will be activated when an alarm or exception occurs, including Event Hint Display, Full Screen Monitoring, Audible Warning (buzzer), Notify Surveillance Center, Trigger Alarm Output and Send Email.

11.2.1 Configure Auto-switch Full Screen Monitoring

Purpose:

When an alarm is triggered, the local monitor displays in full screen the video image from the alarming channel configured for full screen monitoring. And when the alarm is triggered simultaneously in several channels, you must configure the auto-switch dwell time.

Step 1 Go to **System > View > General**.

Step 2 Set the event output and dwell time.

- **Event Output:** Select the output to show event video.
- **Full Screen Monitoring Dwell Time:** Set the time in seconds to show alarm event screen. If alarms are triggered simultaneously in several channels, their full-screen images will be switched at an interval of 10 seconds (default dwell time).

Step 3 Go to the **Linkage Action** interface of the alarm detection (e.g., motion detection, video tampering, face detection, etc.).

Step 4 Select the **Full Screen Monitoring** alarm linkage action.

Step 5 Select the channel(s) in **Trigger Channel** settings you want to make full screen monitoring.



Auto-switch will terminate once the alarm stops and back to the live view interface.

11.2.2 Configure Audio Warning

Purpose:

The audio warning enables the system to trigger an audible *beep* when an alarm is detected.

Step 1 Go to **System>View>General**.

Step 2 Enable the audio output and set the volume.

Step 3 Go to the **Linkage Action** interface of the alarm detection (e.g., motion detection, video tampering, face detection, etc.).

Step 4 Select the **Audio Warning** alarm linkage action.

11.2.3 Notify Surveillance Center

Purpose:

The device can send an exception or alarm signal to the remote alarm host when an event occurs. The alarm host refers to the PC installed with client software (e.g., iVMS-4200, iVMS-5200).

Step 1 Go to **System > Network > Advanced > More Settings**.

Step 2 Set the alarm host IP and alarm host port.

Step 3 Go to the **Linkage Action** interface of the alarm detection (e.g., motion detection, video tampering, face detection, etc.).

Step 4 Select the **Notify Surveillance Center**.

11.2.4 Configure Email Linkage

Purpose:

The system can send an email with alarm information to a user or users when an alarm is detected.

Please refer to Chapter 16.7 Configure Email for details of Email configuration.

Step 1 Go to **System>Network>Advanced**.

Step 2 Configure the Email settings.

Step 3 Go to the **Linkage Action** interface of the alarm detection (e.g., motion detection, video tampering, face detection, etc.).

Step 4 Select the **Send Email** alarm linkage action.

11.2.5 Trigger Alarm Output

Purpose:

The alarm output can be triggered by the alarm input, motion detection, video tampering detection, face detection, line crossing detection, and all other events.

Step 1 Go to the **Linkage Action** interface of the alarm input or event detection (e.g., motion detection, face detection, line crossing detection, intrusion detection, etc.).

Step 2 Click the **Trigger Alarm Output** tab.

Step 3 Select the alarm output (s) to trigger.

Step 1 Go to **System>Event>Normal Event>Alarm Output**.

Step 2 Select an alarm output item from the list.



Refer to Chapter 11.6.3 Configure Alarm Output for the alarm output settings.

11.2.6 Configure PTZ Linkage

Purpose:

The system can trigger the PTZ actions (e.g., call preset/patrol/pattern) when the alarm event, or VCA detection events occur.



Make sure the PTZ or speed dome connected supports PTZ linkage.

Step 1 Go to the **Linkage Action** interface of the alarm input or VCA detection (e.g., face detection, line crossing detection, intrusion detection, etc.).

Step 2 Select the **PTZ Linkage**.

Step 3 Select the camera to perform the PTZ actions.

Step 4 Select the preset/patrol/pattern No. to call when the alarm events occur.

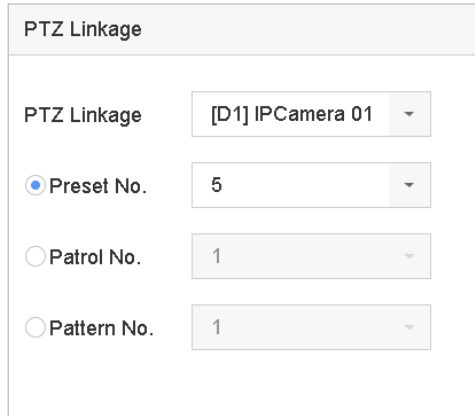

| PTZ Linkage | |
|---|------------------|
| PTZ Linkage | [D1] IPCamera 01 |
| <input checked="" type="radio"/> Preset No. | 5 |
| <input type="radio"/> Patrol No. | 1 |
| <input type="radio"/> Pattern No. | 1 |

Figure 11-2 PTZ Linkage



You can set one PTZ type only for the linkage action each time.

11.3 Configure Motion Detection Alarm

Purpose:

The motion detection enables the device to detect the moving objects in the monitoring area and trigger the alarm.

Step 1 Go to **System > Event > Normal Event > Motion Detection**.

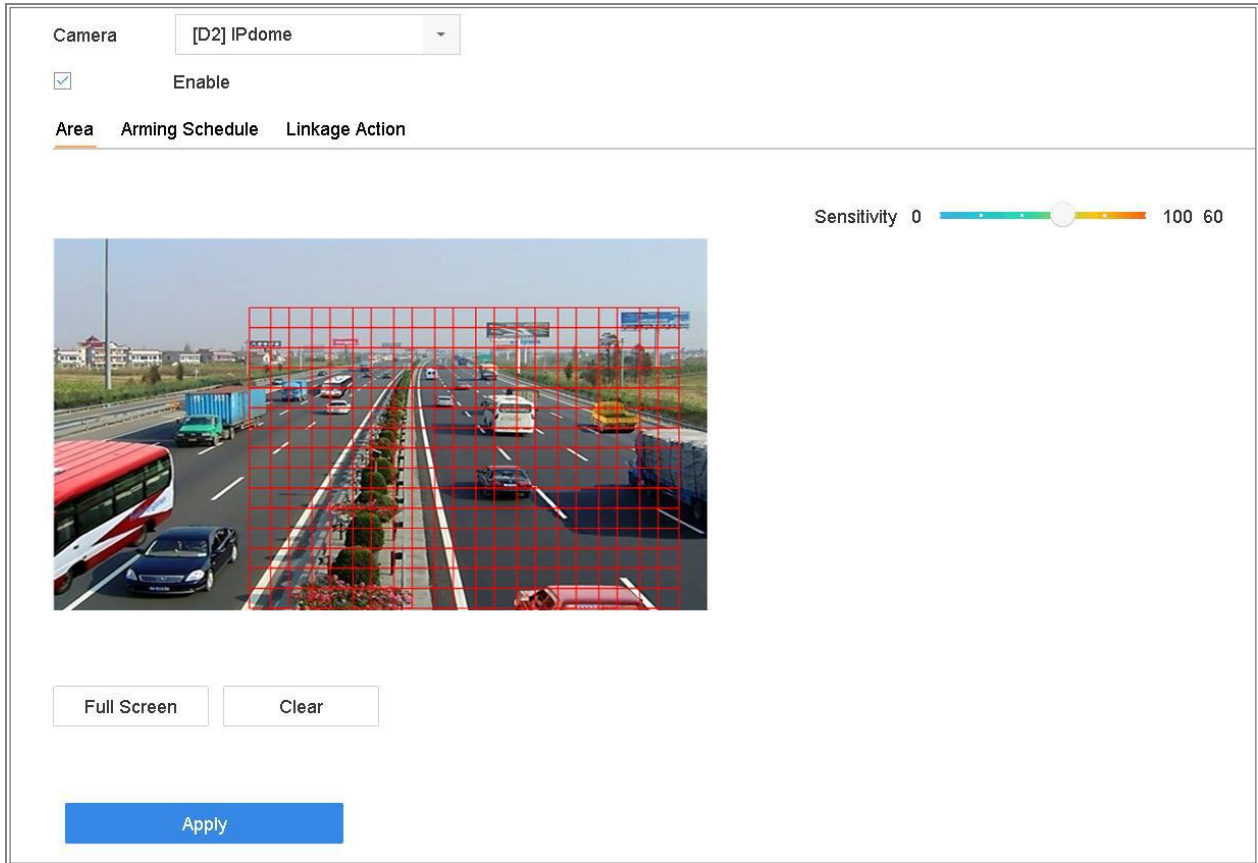

Figure 11-3 Set Motion Detection

Step 2 Select the camera to configure the motion detection.

Step 3 Check **Enable**.

Step 4 Set the motion detection area.

- Full screen: click to set the full-screen motion detection for the image.
- Customized area: use the mouse to click and drag on the preview screen to draw the customized motion detection area (s).

You can click **Clear** to clear the current motion detection area settings and draw again.

Step 5 Set sensitivity (0-100). The sensitivity allows you to calibrate how readily movement triggers the alarm. The higher value results in the more readily to trigger the motion detection.

Step 6 Set the arming schedule. Refer to Chapter 11.1 Configure Arming Schedule.

Step 7 Set the linkage actions. Refer to Chapter 11.2 Configure Alarm Linkage Actions.

11.4 Configure Video Loss Alarm

Purpose:

The video loss detection enables to detect video loss of a channel and take alarm response action(s).

Step 1 Go to **System > Event > Normal Event > Video Loss**

Camera [D1] IPCamera 01

Enable

Arming Schedule Linkage Action

Continuous None Edit

| | 0 | 2 | 4 | 6 | 8 | 10 | 12 | 14 | 16 | 18 | 20 | 22 | 24 | |
|-----|------|------|------|------|------|------|------|------|------|------|------|------|------|---|
| Mon | Blue | Blue | Blue | Blue | Blue | Blue | Blue | Blue | Blue | Blue | Blue | Blue | Blue | 1 |
| Tue | Blue | Blue | Blue | Blue | Blue | Blue | Blue | Blue | Blue | Blue | Blue | Blue | Blue | 2 |
| Wed | Blue | Blue | Blue | Blue | Blue | Blue | Blue | Blue | Blue | Blue | Blue | Blue | Blue | 3 |
| Thu | Blue | Blue | Blue | Blue | Blue | Blue | Blue | Blue | Blue | Blue | Blue | Blue | Blue | 4 |
| Fri | Blue | Blue | Blue | Blue | Blue | Blue | Blue | Blue | Blue | Blue | Blue | Blue | Blue | 5 |
| Sat | Blue | Blue | Blue | Blue | Blue | Blue | Blue | Blue | Blue | Blue | Blue | Blue | Blue | 6 |
| Sun | Blue | Blue | Blue | Blue | Blue | Blue | Blue | Blue | Blue | Blue | Blue | Blue | Blue | 7 |

Apply

Figure 11-4 Set Video Loss Detection

Step 2 Select the camera to configure the video loss detection.

Step 3 Check **Enable**.

Step 4 Set the arming schedule. Refer to Chapter 11.1 Configure Arming Schedule.

Step 5 Set the linkage actions. Refer to Chapter 11.2 Configure Alarm Linkage Actions.

11.5 Configure Video Tampering Alarm

Purpose:

The video tampering detection enables to trigger alarm when the camera lens is covered and take alarm response action(s).

Step 1 Go to **System> Event>Normal Event>Video Tampering**.

Step 2 Select the camera to configure the video tampering detection.

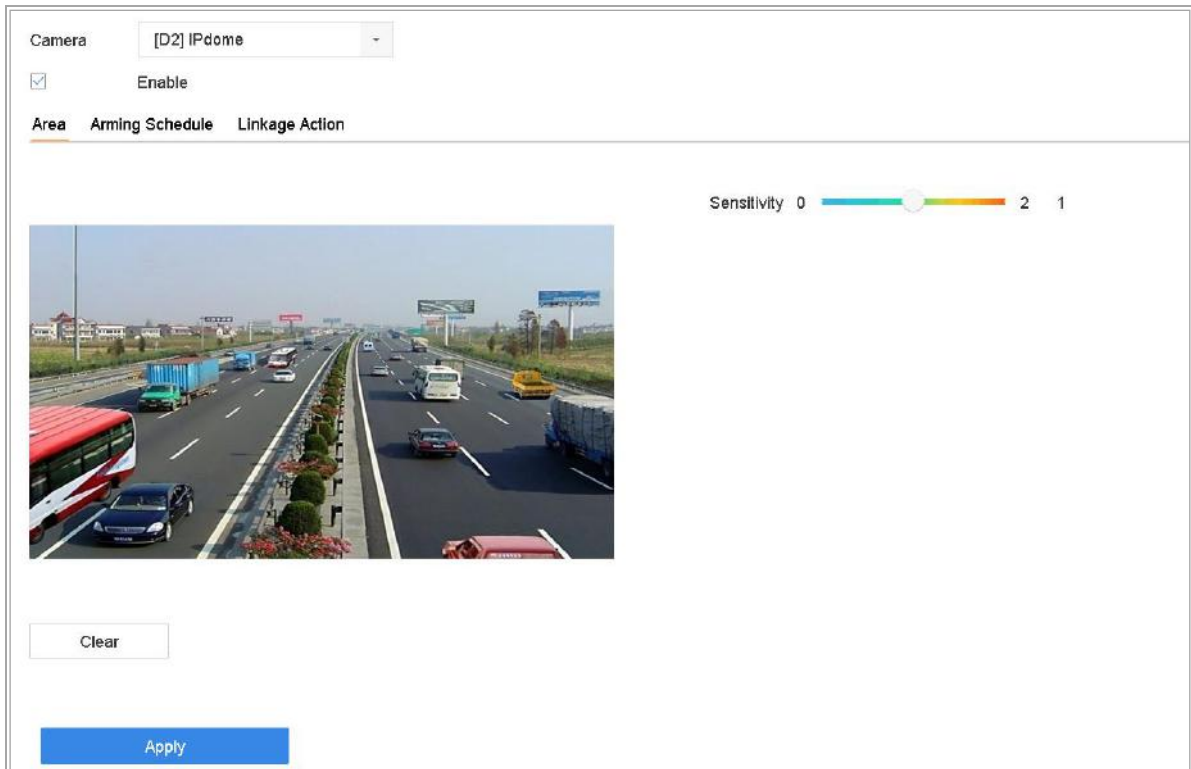

Figure 11-5 Set Video Tampering Setting

Step 3 Check **Enable**.

Step 4 Set the video tampering area. Use the mouse to click and drag on the preview screen to draw the customized video tampering area.

You can click **Clear** to clear the current area settings and draw again.

Step 5 Set sensitivity level (0-2). 3 levels are available. The sensitivity allows you to calibrate how readily movement triggers the alarm. The higher value results in the more readily to trigger the video tampering detection.

Step 6 Set the arming schedule. Refer to Chapter 11.1 Configure Arming Schedule.

Step 7 Set the linkage actions. Refer to Chapter 11.2 Configure Alarm Linkage Actions.

11.6 Configure Sensor Alarms

Purpose:

Set the handling action of an external sensor alarm.

11.6.1 Configure Alarm Input

Step 1 Go to **System> Event>Normal Event>Alarm Input**

Step 2 Select an alarm input item from the list and click .

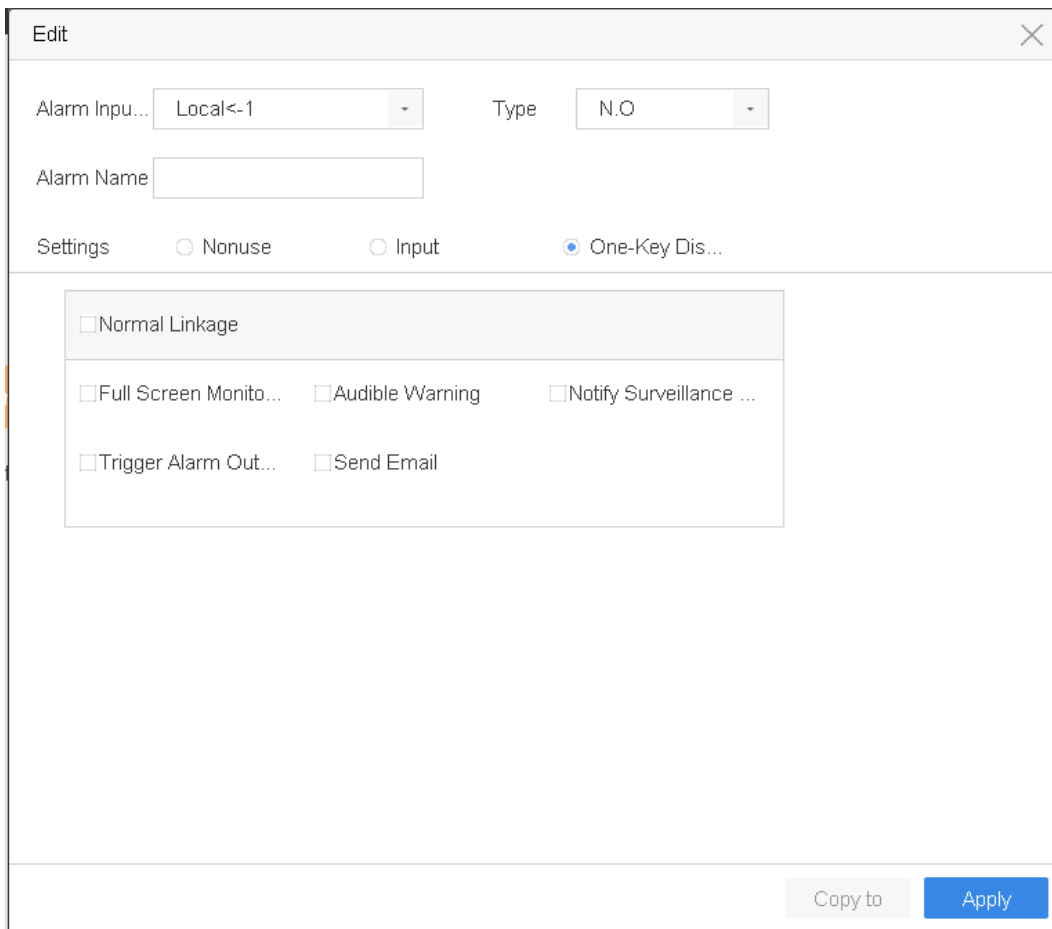

The screenshot shows a dialog box titled "Edit" with a close button (X) in the top right corner. It contains the following fields and options:

- Alarm Input...**: A dropdown menu showing "Local<-1".
- Type**: A dropdown menu showing "N.O".
- Alarm Name**: An empty text input field.
- Settings**: Three radio buttons: "Nonuse", "Input", and "One-Key Dis..." (which is selected).
- A list of linkage actions, each with a checkbox:
 - Normal Linkage
 - Full Screen Monito...
 - Audible Warning
 - Notify Surveillance ...
 - Trigger Alarm Out...
 - Send Email
- At the bottom right, there are two buttons: "Copy to" (disabled) and "Apply" (active).

Figure 11-6 Alarm Input

Step 3 Select the alarm input type to **N.C** or **N.O**.

Step 4 Edit **Alarm Name**.

Step 5 Select **Input**.

Step 6 Set the arming schedule. Refer to Chapter 11.1 Configure Arming Schedule.

Step 7 Set the linkage actions. Refer to Chapter 11.2 Configure Alarm Linkage Actions.

Step 8 Click **Apply** and follow the message box to reboot device to take effect the settings.

11.6.2 Configure One-Key Disarming

Purpose:

The one-key disarming enables the device to disarm the alarm input 1 by one-key operation.

Step 1 Go to **System> Event>Normal Event>Alarm Input**

Step 2 Select the alarm input1 item from the list and click .

Step 3 Select the alarm input type to N.C or N.O.

Step 4 Edit the alarm name.

Step 5 Check the radio button of **Enable One-Key Disarming**.

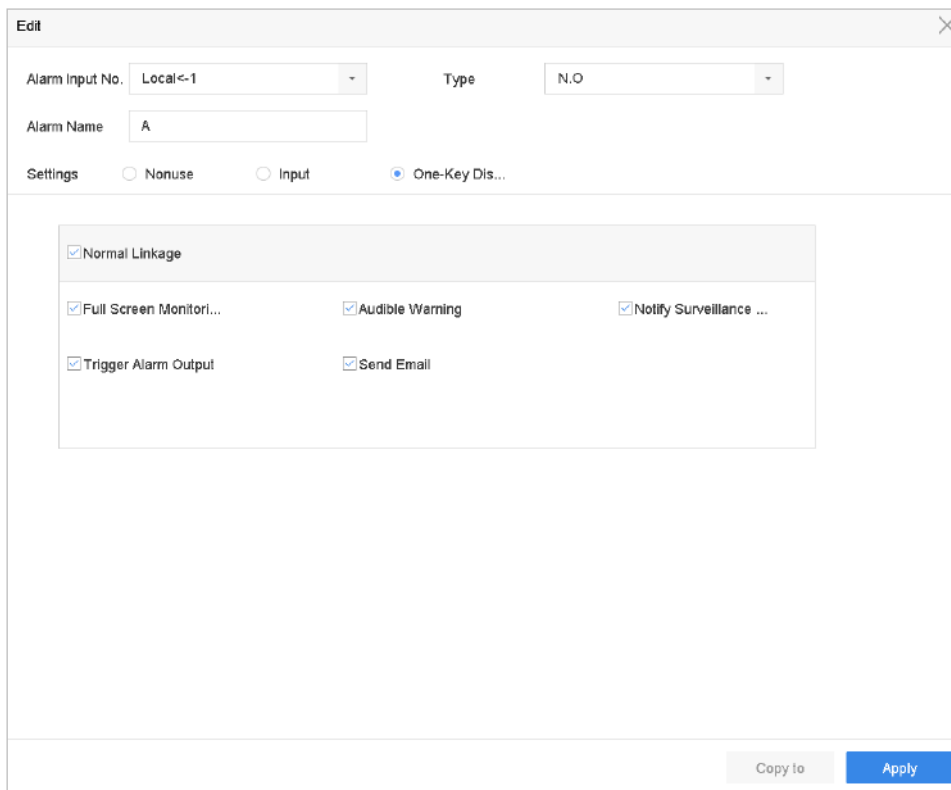

The screenshot shows a web-based configuration window titled "Edit". It contains the following fields and options:

- Alarm Input No.:** Local<-1 (dropdown menu)
- Type:** N.O. (dropdown menu)
- Alarm Name:** A (text input field)
- Settings:** Three radio buttons: "Nonuse", "Input", and "One-Key Dis..." (which is selected).
- Linkage Actions:** A list of actions with checkboxes:
 - Normal Linkage
 - Full Screen Monitori...
 - Audible Warning
 - Notify Surveillance ...
 - Trigger Alarm Output
 - Send Email
- Buttons:** "Copy to" (disabled) and "Apply" (active).

Figure 11-7 One-Key Alarm Disarming

Step 6 Select the alarm linkage action (s) you want to disarm for the local alarm input1.

NOTE

When the alarm input 1 (Local<-1) is enabled with one-key disarming, the other alarm input settings are not configurable.

Step 7 Click **Apply** to save the settings.

11.6.3 Configure Alarm Output

Purpose:

Trigger an alarm output when an alarm is triggered.

Step 1 Go to **System> Event>Normal Event>Alarm Output**.

Step 2 Select an alarm output item from the list and click .

Step 3 Edit **Alarm Name**.

Step 4 Select **Dwell Time** (the alarm duration) from 5s to 600s, or **Manually Clear**.

Manually Clear: You should manually clear the alarm when the alarm occurs. Refer to Chapter 11.8 Trigger or Clear Alarm Output Manually for detailed instructions.

Step 5 Set the arming schedule. Refer to Chapter 11.1 Configure Arming Schedule.

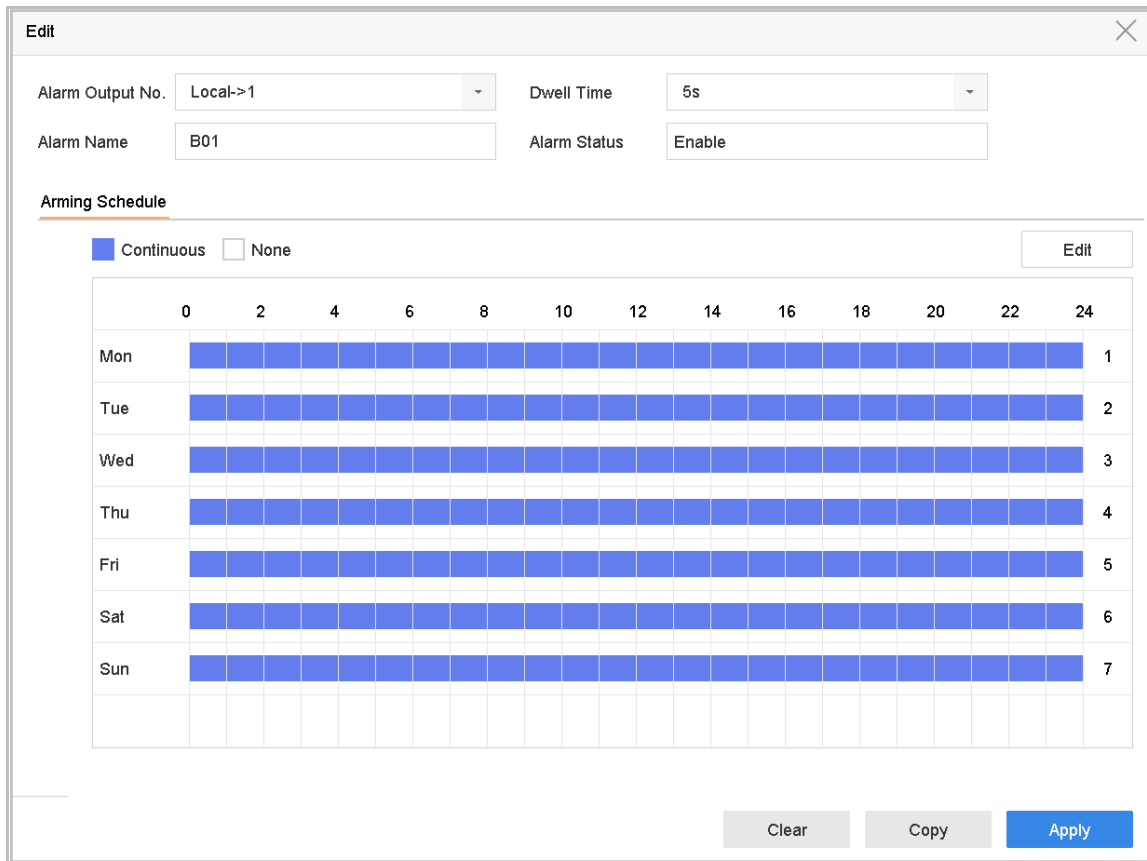

Edit

Alarm Output No. Local->1 Dwell Time 5s

Alarm Name B01 Alarm Status Enable

Arming Schedule

Continuous None Edit

| | 0 | 2 | 4 | 6 | 8 | 10 | 12 | 14 | 16 | 18 | 20 | 22 | 24 | |
|-----|---|---|---|---|---|----|----|----|----|----|----|----|----|---|
| Mon | █ | █ | █ | █ | █ | █ | █ | █ | █ | █ | █ | █ | █ | 1 |
| Tue | █ | █ | █ | █ | █ | █ | █ | █ | █ | █ | █ | █ | █ | 2 |
| Wed | █ | █ | █ | █ | █ | █ | █ | █ | █ | █ | █ | █ | █ | 3 |
| Thu | █ | █ | █ | █ | █ | █ | █ | █ | █ | █ | █ | █ | █ | 4 |
| Fri | █ | █ | █ | █ | █ | █ | █ | █ | █ | █ | █ | █ | █ | 5 |
| Sat | █ | █ | █ | █ | █ | █ | █ | █ | █ | █ | █ | █ | █ | 6 |
| Sun | █ | █ | █ | █ | █ | █ | █ | █ | █ | █ | █ | █ | █ | 7 |

Clear Copy Apply

Figure 11-8 Alarm Output

Step 6 (Optional) You can click **Copy** to copy the same settings to other alarm output (s).

Step 7 Click **Apply**.

11.7 Configure Exceptions Alarm

Purpose:

The exception events can be configured to take the event hint in the live view window, trigger alarm output and linkage actions.

Step 1 Go to **System > Event > Normal Event > Exception**.

Step 2 (Optional) Enable the event hint if you want to display the event hint in the live view window.

- 1) Check **Enable Event Hint**.
- 2) Click  to select the exception type (s) to take the event hint.

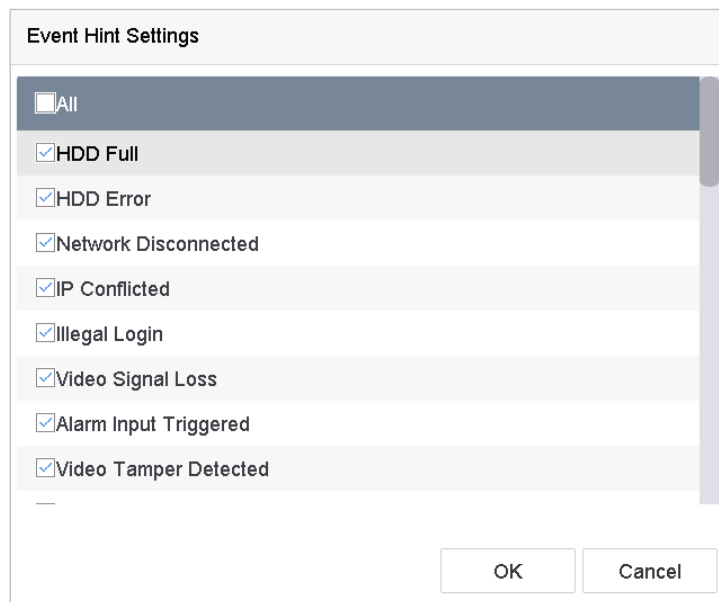

Figure 11-9 Event Hint Settings

Step 3 Select the exception type from the drop-down list to set the linkage actions.

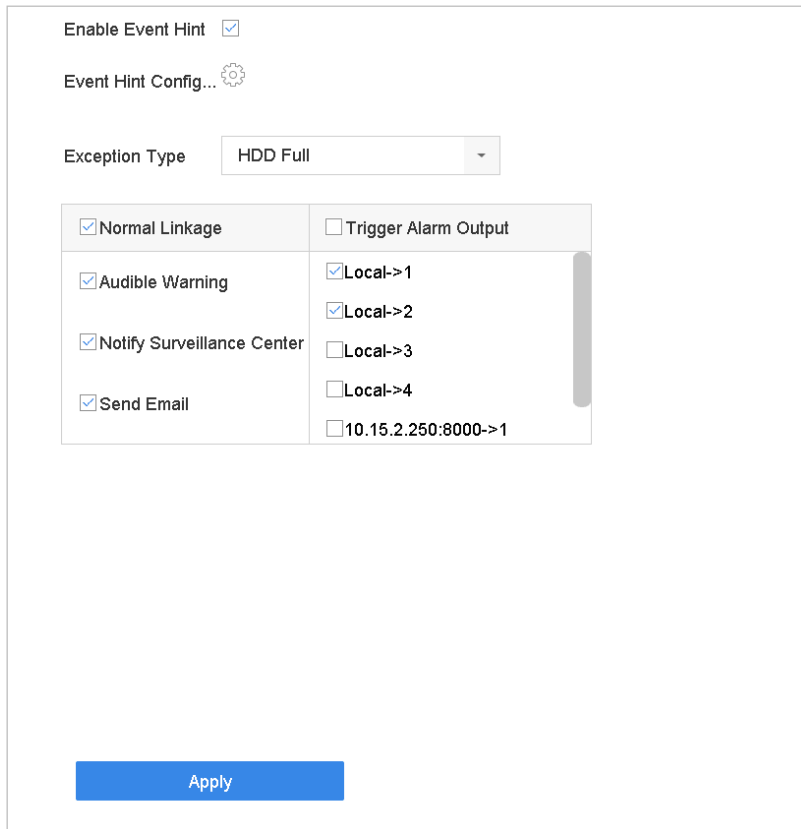

Figure 11-10 Exceptions Handling

Step 4 Set the normal linkage and alarm output triggering. Refer to 11.2 Configure Alarm Linkage Actions.

11.8 Trigger or Clear Alarm Output Manually

Purpose:

Sensor alarm can be triggered or cleared manually. When **Manually Clear** is selected for the dwell time of an alarm output, the alarm can be cleared only by clicking **Clear**.

Step 1 Go to **System> Event>Normal Event>Alarm Output**.

Step 2 Select the alarm output you want to trigger or clear and click .

Step 3 Click **Trigger/Clear** to trigger or clear an alarm output.

Edit

Alarm Output No. Local->1 Dwell Time 5s

Alarm Name B01 Alarm Status Enable

Arming Schedule

| | 00 | 02 | 04 | 06 | 08 | 10 | 12 | 14 | 16 | 18 | 20 | 22 | 24 |
|---------|-------|-------|-------|-------|-------|-------|-------|-------|-------|-------|-------|-------|-------|
| Mon | Armed | Armed | Armed | Armed | Armed | Armed | Armed | Armed | Armed | Armed | Armed | Armed | Armed |
| Tue | Armed | Armed | Armed | Armed | Armed | Armed | Armed | Armed | Armed | Armed | Armed | Armed | Armed |
| Wed | Armed | Armed | Armed | Armed | Armed | Armed | Armed | Armed | Armed | Armed | Armed | Armed | Armed |
| Thu | Armed | Armed | Armed | Armed | Armed | Armed | Armed | Armed | Armed | Armed | Armed | Armed | Armed |
| Fri | Armed | Armed | Armed | Armed | Armed | Armed | Armed | Armed | Armed | Armed | Armed | Armed | Armed |
| Sat | Armed | Armed | Armed | Armed | Armed | Armed | Armed | Armed | Armed | Armed | Armed | Armed | Armed |
| Sun | Armed | Armed | Armed | Armed | Armed | Armed | Armed | Armed | Armed | Armed | Armed | Armed | Armed |
| Holiday | Armed | Armed | Armed | Armed | Armed | Armed | Armed | Armed | Armed | Armed | Armed | Armed | Armed |

× Delete 🗑️ Delete All

Clear Copy Apply

Figure 11-11 Alarm Output

Chapter 12 POS Configuration

The device can be connected with the POS machine/server, and receive the transaction message for overlay on the image during the live view or playback, as well as trigger the POS event alarm.



This chapter is only applicable to DS-7300/8100HQHI-K, DS-7300/8100/9000HUHI-K, DS-7300/8100/9000HTHI-K, iDS-7316HUHI-K4/16S and iDS-9016HUHI-K8/16S series DVR.

12.1 Configure POS Settings

12.1.1 Configure POS Connection

Step 1 Go to **System > POS Settings**.

Step 2 Click **Add** to enter the POS adding interface.

Step 3 Select a POS from the drop-down list.

Step 4 Check **Enable**.



The amount of POS devices supported for each device is the half of its channel amount, e.g., 8 POS devices are supported for the DS-9616NI-I8 model.

Figure 12-1 POS Settings

Step 5 Select the POS protocol to Universal Protocol, EPSON, AVE or NUCLEUS.



When the new protocol is selected, you should reboot the device to activate the new settings.

● Universal Protocol

Click the **Advanced** button to expand more settings when selecting the universal protocol. You can set the start line identifier, line break tag and end line tag for the POS overlay characters, and the case-sensitive property of the characters. You can also optionally check the filtering identifier and the XML protocol.

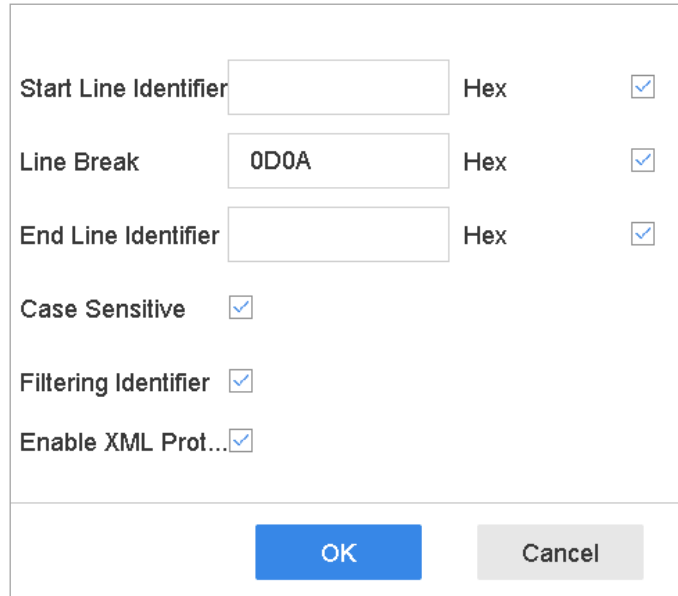

The dialog box contains the following settings:

- Start Line Identifier: Hex
- Line Break: Hex
- End Line Identifier: Hex
- Case Sensitive:
- Filtering Identifier:
- Enable XML Prot...:

Buttons:

Figure 12-2 Universal Protocol Settings

- EPSON

The fixed start and end line tag are used for EPSON protocol.

- AVE

The fixed start and end line tag are used for AVE protocol. And the serial port and virtual serial port connection types are supported.

- 1) Click the **Custom** to configure the AVE settings.
- 2) Se the rule to VSI-ADD or VNET.
- 3) Set the address bit of the POS message to send.
- 4) Click **OK** to save the settings.

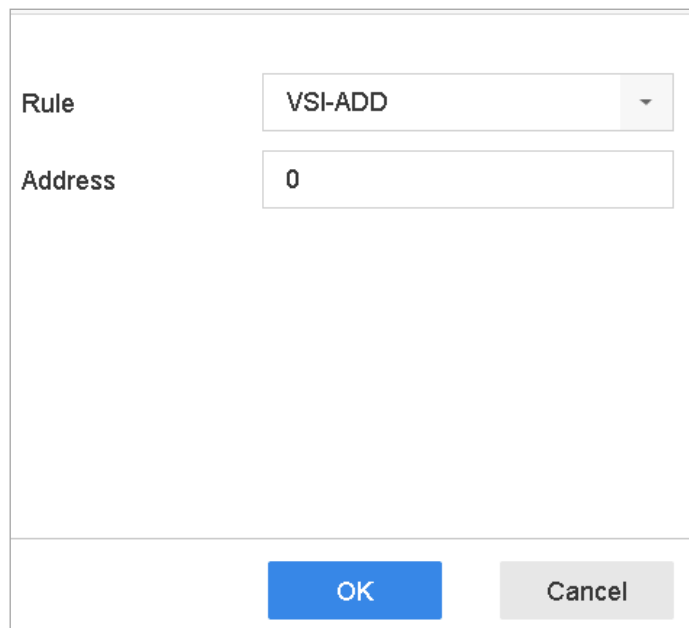

The dialog box contains the following settings:

- Rule:
- Address:

Buttons:

Figure 12-3 AVE Settings

● NUCLEUS

- 1) Click the **Custom** to configure the NUCLEUS settings.
- 2) Enter the employee No. shift No. and the terminal No. in the field. The matching message sent from the POS device will be used as the valid POS data.



The NUCLEUS protocol must be used in the RS-232 connection communication.

Step 6 Select the connection mode to TCP Reception, UDP Reception, Multicast, RS-232, USB-to-RS-232 or Sniff, and click **Parameters** to configure the parameters for each connection mode.

● TCP Connection

- 1) When using TCP connection, the port must be set from 1 to 65535, and the port for each POS machine must be unique.
- 2) Set the **Allowed Remote IP Address** of the device sending the POS message.

| TCP Connection Settings | |
|---|------------------|
| Port | 10010 |
| Allowed Remote IP A... | 192 . 0 . 0 . 64 |
| <input type="button" value="OK"/> <input type="button" value="Cancel"/> | |

Figure 12-4 TCP Connection Settings

● UDP Connection

- 1) When using UDP connection, the port must be set from 1 to 65535, and the port for each POS machine must be unique.
- 2) Set the **Allowed Remote IP Address** of the device sending the POS message.

● USB-to-RS-232 Connection

Configure the port parameters of USB-to-RS-232 convertor, including the serial number of port, baud rate, data bit, stop bit, parity and flow ctrl.

| USB-to-RS-232 Settings | |
|---|------|
| Serial Port Number | 1 |
| Baud Rate | 4800 |
| Data Bit | 5 |
| Stop Bit | 1 |
| Parity | None |
| Flow Ctrl | None |
| <input type="button" value="OK"/> <input type="button" value="Cancel"/> | |

Figure 12-5 USB-to-RS-232 Settings

- RS-232 Connection

Connect the device and the POS machine via RS-232. The RS-232 settings can be configured in Menu>Configuration>RS-232. The Usage must be set to Transparent Channel.

- Multicast Connection

When connecting the device and the POS machine via Multicast protocol, set the multicast address and port.

- Sniff Connection

Connect the device and the POS machine via Sniff. Configure the source address and destination address settings.

The image shows a 'Sniff Settings' dialog box with the following fields and values:

- Enable Source Port Filter:**
- Source Address:** 18 . 16 . 1 . 1
- Source Port:** 10020
- Enable Destination Address Filter:**
- Enable Destination Port Filter:**
- Destination Address:** 20 . 18 . 1 . 24
- Destination Port:** 10030

Buttons: OK, Cancel

Figure 12-6 Sniff Settings

12.1.2 Configure POS Text Overlay

Step 1 Go to **System > POS Settings**.

Step 2 Click **Channel Linkage and Display** tab.

Step 3 Select the linked channel to overlay the POS characters.

Step 4 Set the characters overlay for the enabled POS.

- Character encoding format: currently the Latin-1 format is available.
- Overlay mode of the characters to display in scrolling or page mode.
- Font size and font color.
- Display time (sec) of the characters. The value ranges 5 -3600 sec.
- Timeout of POS event. The value ranges 5 -3600 sec. When the device has not received the POS message over the defined time, the transaction is finished.

Step 5 In the **Privacy Settings**, set the POS privacy information to not display on the image, e.g., the card number, or the user name, etc.

Result: The defined privacy information will be displayed in ***on the image instead.

Step 6 (optional) Check the checkbox to enable the **Overlay POS in Live View**. When this feature is enabled, the POS information can be overlain on the live view image.

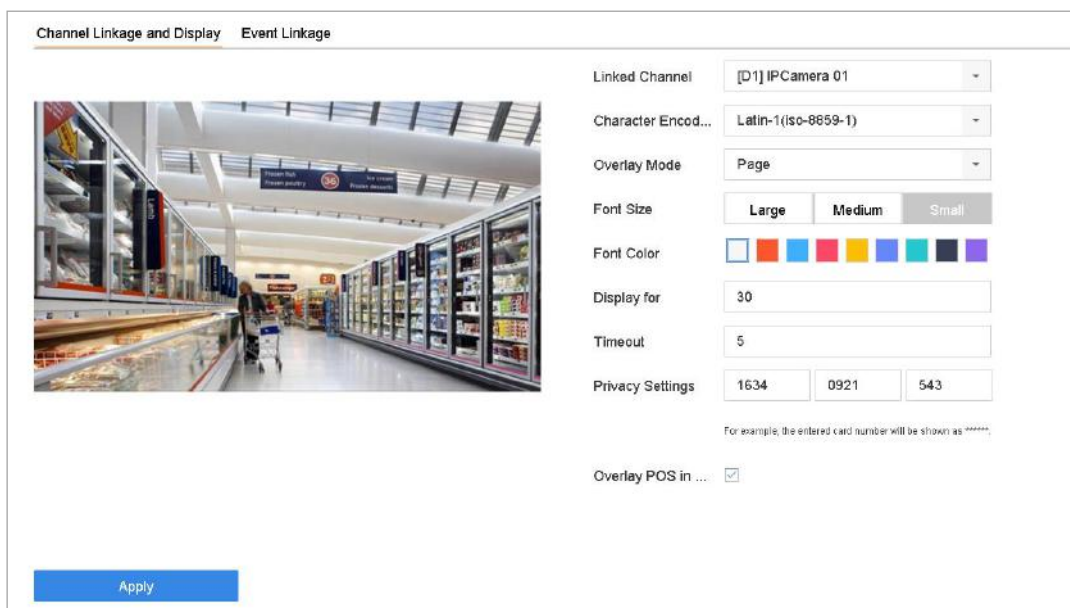

Figure 12-7 Overlay Character Settings

 **NOTE**

You can adjust the size and position of textbox on the preview screen of POS settings interface by dragging the frame.

Step 7 Click **Apply** to activate the settings.

12.2 Configure POS Alarm

Purpose:

The POS event can trigger channels to start recording, or trigger full screen monitoring, audio warning, notifying the surveillance center, sending email and so on.

Step 1 Go to **Storage > Recording Schedule**.

Step 2 Set the arming schedule of the POS event.

Step 3 Go to **System > POS Settings**.

Step 4 On the POS adding or editing interface, click the **Event Linkage** tab.

Step 5 Select the normal linkage actions: full screen monitoring, audio warning or send Email.

Step 6 Select one or more alarm output (s) to trigger.

Step 7 Select one or more channels to record or become full-screen monitoring when POS alarm is triggered.

Channel Linkage and Display Event Linkage

| | | |
|--|---|--|
| <input checked="" type="checkbox"/> Normal Linkage | <input type="checkbox"/> Trigger Alarm Output | <input type="checkbox"/> Trigger Channel |
| <input checked="" type="checkbox"/> Full Screen Monitoring | <input checked="" type="checkbox"/> Local->1 | <input checked="" type="checkbox"/> D1 |
| <input checked="" type="checkbox"/> Audible Warning | <input type="checkbox"/> Local->2 | <input checked="" type="checkbox"/> D2 |
| <input checked="" type="checkbox"/> Send Email | <input checked="" type="checkbox"/> Local->3 | <input type="checkbox"/> D3 |
| | <input type="checkbox"/> Local->4 | <input type="checkbox"/> D4 |
| | <input type="checkbox"/> 10.15.2.250:8000->1 | |

*Notice: please confirm the event output in "Live View" settings menu is the same with the real event output.

Apply

Figure 12-8 Set Trigger Cameras of POS

Step 8 Click **Apply** to save the settings.

Chapter 13 VCA Event Alarm

The device supports receiving the VCA detections sent by connected IP cameras. Enable and configure the VCA detection on the IP camera settings interface first.



NOTE

- VCA detections must be supported by the connected IP camera.
- Refer to the User Manual of Network Camera for the detailed instructions for the VCA detection.

13.1 Human Body Detection

Purpose:

The human body detection is used to detect the human body appearing in the monitoring scene, and capture the human body pictures.



NOTE

This feature is available only when the connected camera supports the human body detection.

Step 1 Go to **System > Event > Smart Event**.

Step 2 Click **Human Body**.

Step 3 Select the camera to configure the human body detection.

Step 4 Check **Save VCA Picture** to save the captured pictures of human body detection.

Step 5 Check **Target of Interest (Human Body)** to discard non-human body pictures and videos which are not triggered by human body detection.

Step 6 Set detection area.

- 1) Select the detection area to configure from the **Area** drop-down list. Up to 8 detection areas are selectable.
- 2) Check the checkbox of **Enable Area** to enable the selected detection area.
- 3) Edit the area name in the **Scene Name**. The scene name can contain up to 32 characters.

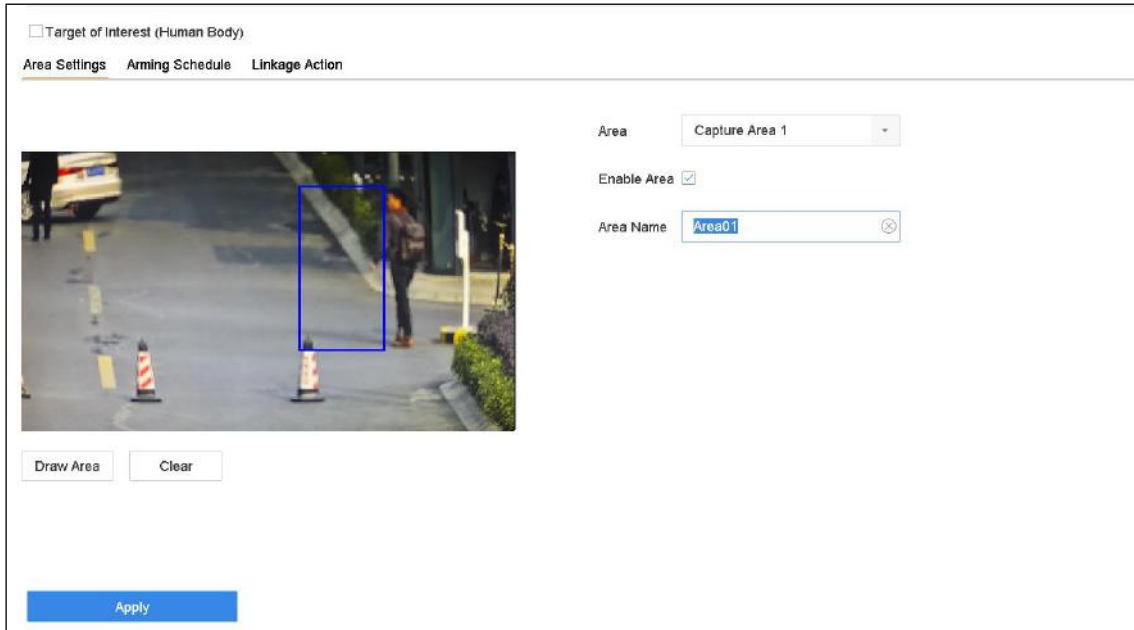

Figure 13-1 Human Body Detection

- 4) Click **Draw Area** to draw a quadrilateral in the preview window and then click **Stop Drawing**.

Related Operation: You can click **Clear** to clear the existing virtual line and re-draw it.

Step 7 Set the arming schedule. Refer to Chapter 11.1 Configure Arming Schedule.

Step 8 Set the linkage actions. Refer to Chapter 11.2 Configure Alarm Linkage Actions.

Step 9 Click **Apply** to activate the settings.

13.2 Face Detection

Purpose:

Face detection function detects the face appears in the surveillance scene. Linkage actions will be triggered when a human face is detected.

Step 1 Go to **System > Event > Smart Event**.

Step 2 Click **Face Detection**.

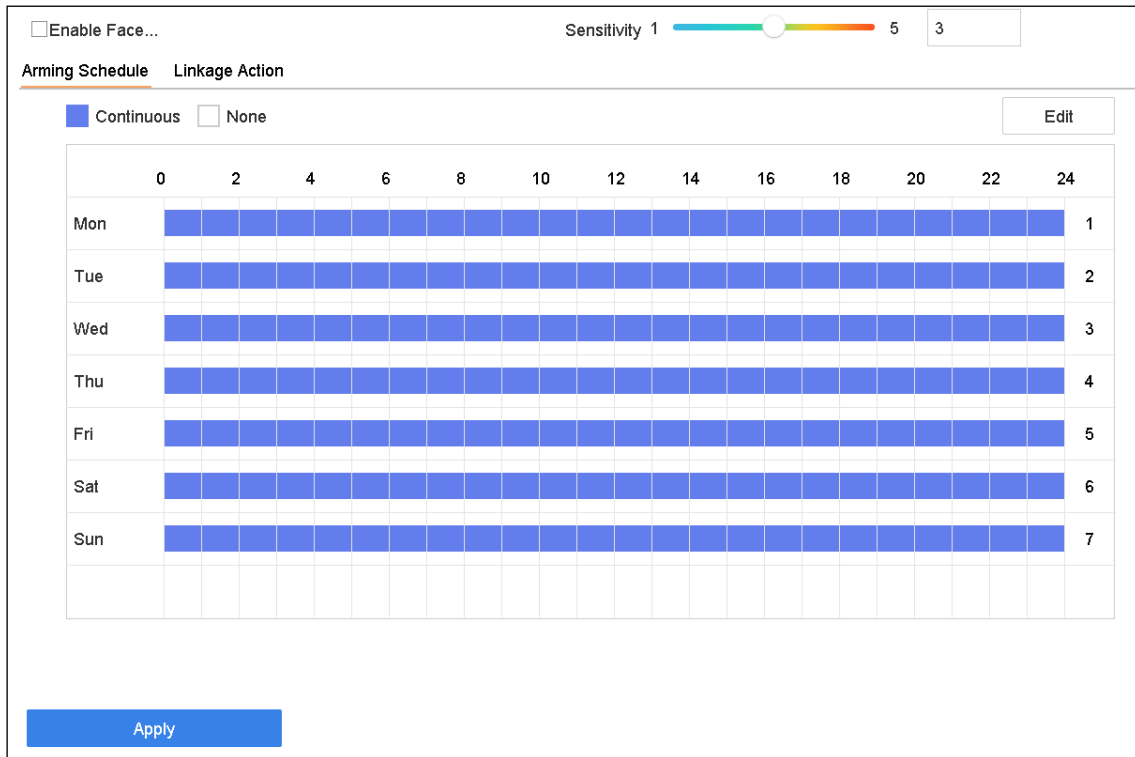

Figure 13-2 Face Detection

Step 3 Select a camera to configure.

Step 4 Check **Enable Face Detection**.

Step 5 Optionally, check **Save VCA Picture** to save the captured pictures of face detection.

Step 6 Drag the **Sensitivity** slider to set the detection sensitivity. Sensitivity range: [1-5]. The higher the value is, the more easily the face can be detected.

Step 7 Set the arming schedule. Refer to Chapter 11.1 Configure Arming Schedule.

Step 8 Set the linkage actions. Refer to Chapter 11.2 Configure Alarm Linkage Actions.

Step 9 Click **Apply**.

13.3 Vehicle Detection

Purpose:

Vehicle Detection is available for the road traffic monitoring. In Vehicle Detection, the passed vehicle can be detected and the picture of its license plate can be captured. You can send alarm signal to notify the surveillance center and upload the captured picture to FTP server.

Step 1 Go to **System > Event > Smart Event**.

Step 2 Click **Vehicle**.

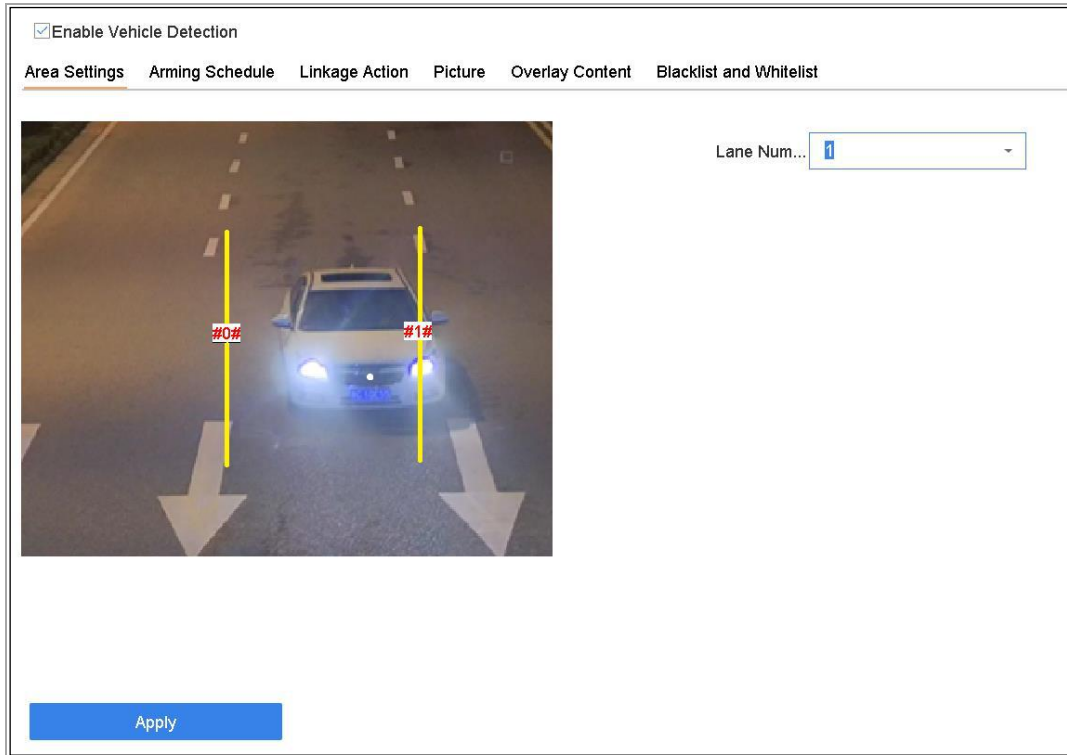

Figure 13-3 Vehicle Detection

Step 3 Select a camera to configure.

Step 4 Check **Enable Vehicle Detection**.

Step 5 Optionally, check **Save VCA Picture** to save the captured pictures of vehicle detection.

Step 6 Set the arming schedule. Refer to Chapter 11.1 Configure Arming Schedule.

Step 7 Set the linkage actions. Refer to Chapter 11.2 Configure Alarm Linkage Actions.

Step 8 Configure rules, including **Area Settings**, **Picture**, **Overlay Content**, and **Blacklist and Whitelist**. Area Settings: Up to 4 lanes are selectable.

Step 9 Click **Save**.

 **NOTE**

Refer to the User Manual of Network Camera for the detailed instructions for the vehicle detection.

13.4 Line Crossing Detection

Purpose:

Line crossing detection detects people, vehicles, and objects crossing a set virtual line. The detection direction can be set as bidirectional, from left to right or from right to left.

Step 1 Go to **System > Event > Smart Event**.

Step 2 Click **Line Crossing**.

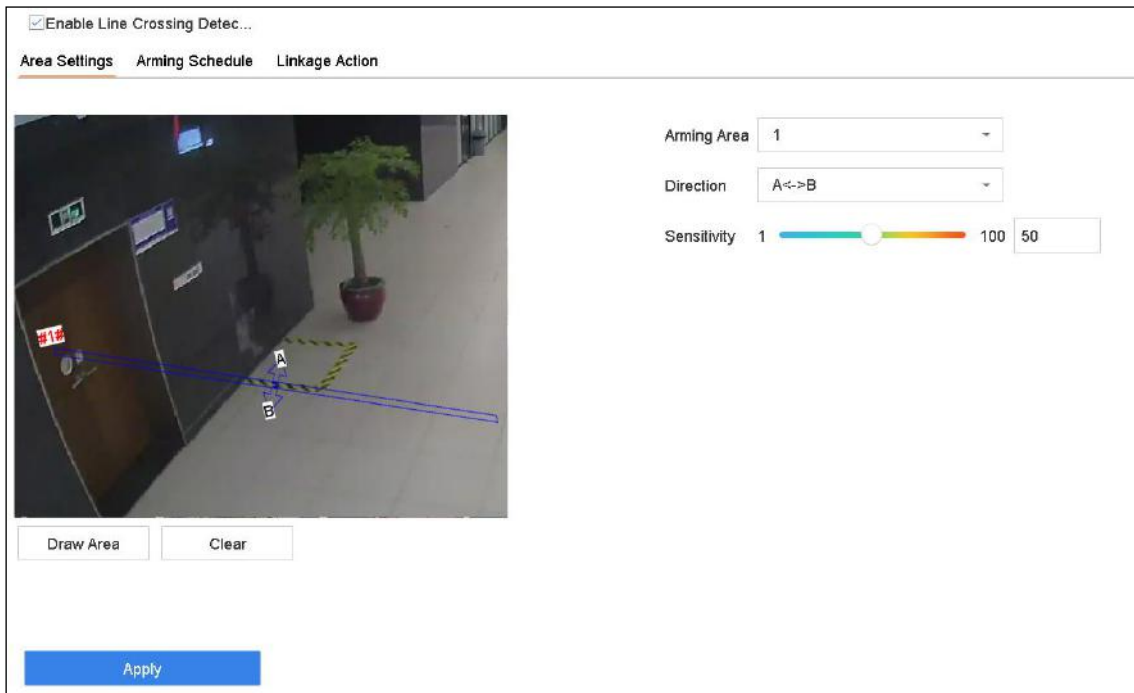

Figure 13-4 Line Crossing Detection

Step 3 Select a camera to configure.

Step 4 Check **Enable Line Crossing Detection** checkbox.

Step 5 Optionally, check **Save VCA Picture** to save the captured pictures of line crossing detection.

Step 6 Follow the steps to set the line crossing detection rules and detection areas.

- 1) Select an Arming Region to configure.
- 2) Select the Direction as A<->B, A->B, or A<-B.

A<->B: Only the arrow on the B side shows. When an object goes across the configured line with both directions can be detected and alarms are triggered.

A->B: Only the object crossing the configured line from the A side to the B side can be detected.

B->A: Only the object crossing the configured line from the B side to the A side can be detected.

- 3) Drag the Sensitivity slider to set the detection sensitivity. Sensitivity range: sensitivity. The higher the value is, the more easily the detection alarm can be triggered.
- 4) Click Draw Region and set two points in the preview window to draw a virtual line.

Step 7 Set the arming schedule. Refer to Chapter 11.1 Configure Arming Schedule.

Step 8 Set the linkage actions. Refer to Chapter 11.2 Configure Alarm Linkage Actions.

Step 9 Click **Apply**.

 **NOTE**

For iDS-7200HQHI-K/S and iDS-7200HUHI-K/S series, you can check to enable human body and vehicle detection.

13.5 Intrusion Detection

Purpose:

Intrusion detection function detects people, vehicle or other objects which enter and loiter in a pre-defined virtual region, and some certain actions can be taken when the alarm is triggered.

Step 1 Go to **System > Event > Smart Event**.

Step 2 Click **Intrusion**.

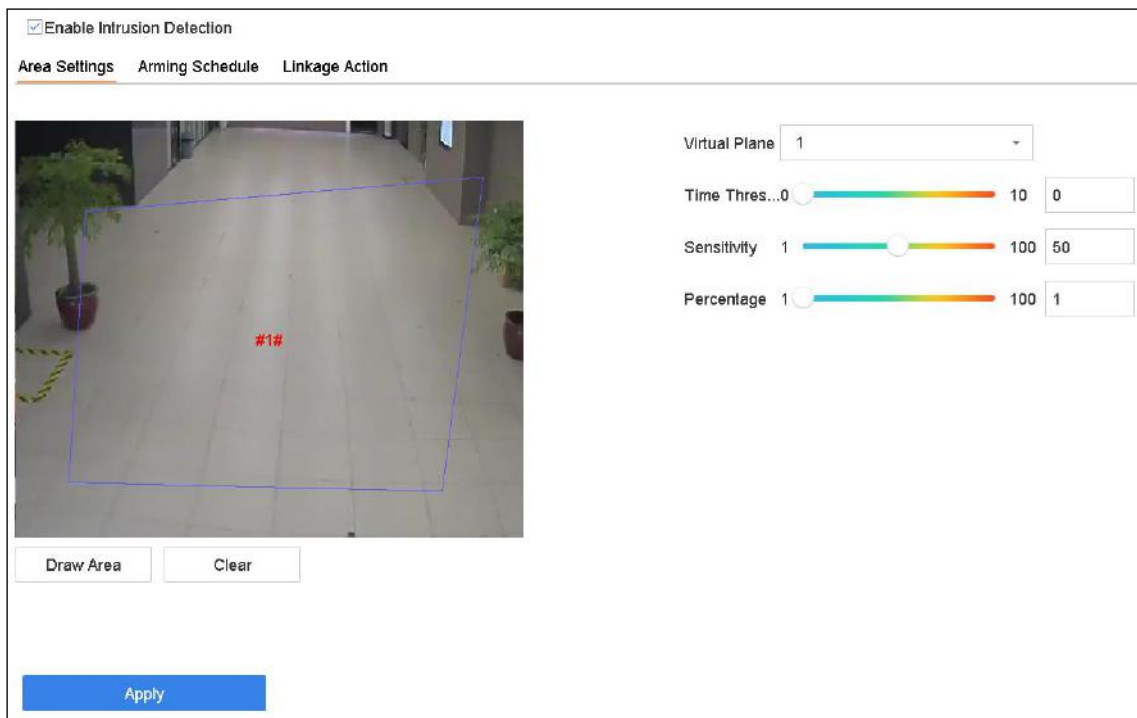

Figure 13-5 Intrusion Detection

Step 3 Select a camera to configure.

Step 4 Check **Enable Intrusion Detection**.

Step 5 Optionally, check **Save VCA Picture** to save the captured pictures of intrusion detection.

Step 6 Follow the steps to set the detection rules and detection areas.

- 1) Select a Virtual Panel to configure.
- 2) Drag the sliders to set Time Threshold, Sensitivity, and Percentage.
 - **Time Threshold:** The threshold for the time of the object loitering in the region. When the duration of the object in the defined detection area is longer than the threshold, device will trigger an alarm. Its range is [0s-2s] for analog cameras.
 - **Sensitivity:** The size of the object that can trigger the alarm. The higher the value is, the more easily the detection alarm can be triggered. Its range is [1-100].
 - **Percentage:** The ratio of the in-region part of the object that can trigger the alarm. For example, if the percentage is 50%, when the object enters the region and occupies half of the whole region, device will trigger an alarm. Its range is [1-100].
- 3) Click Draw Region and draw a quadrilateral in the preview window by specifying four vertexes of the detection region.

Step 7 Set the arming schedule. Refer to Chapter 11.1 Configure Arming Schedule.

Step 8 Set the linkage actions. Refer to Chapter 11.2 Configure Alarm Linkage Actions.

Step 9 Click **Apply**.



For iDS-7200HQHI-K/S and iDS-7200HUHI-K/S series, you can check to enable human body and vehicle detection.

13.6 Region Entrance Detection

Purpose:

Region entrance detection function detects objects that enter a pre-defined virtual region from the outside place.

Step 1 Go to **System Management > Event Settings > Smart Event**.

Step 2 Click the **Region Entrance Detection** item.

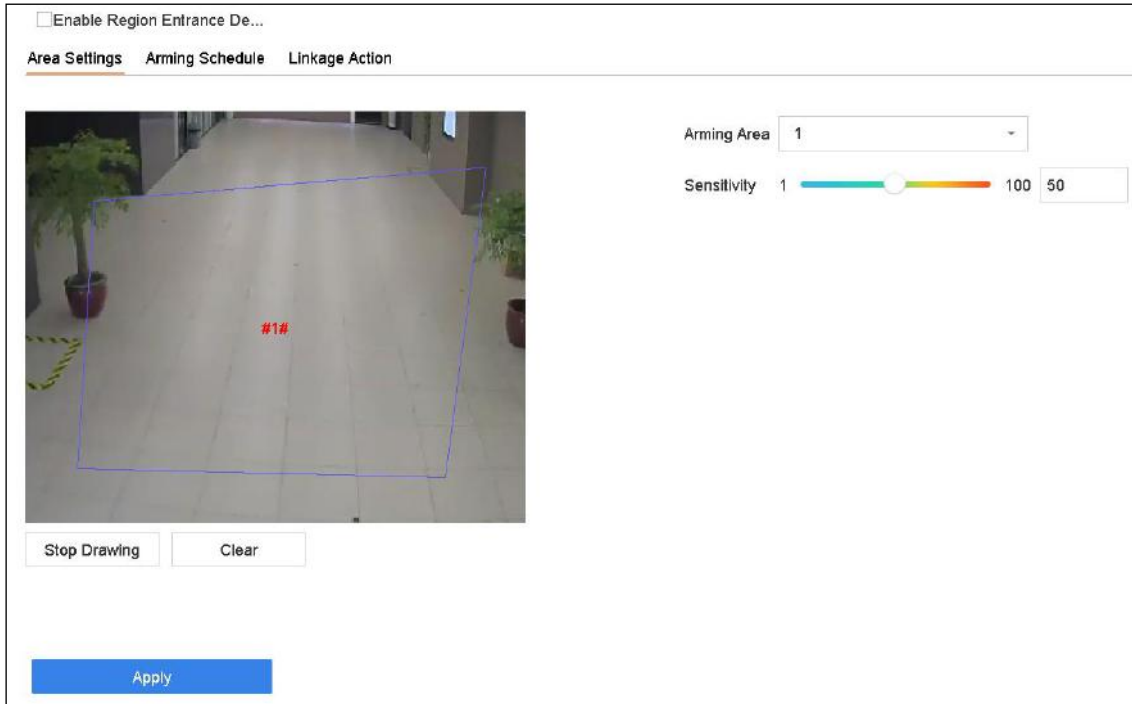

Figure 13-6 Region Entrance Detection

Step 3 Select a camera to configure.

Step 4 Check **Enable Region Entrance Detection** checkbox.

Step 5 Optionally, check **Save VCA Picture** checkbox to save the captured pictures of region entrance detection.

Step 6 Follow the steps to set the detection rules and detection areas.

- 1) Select an Arming Region to configure. Up to 4 regions are selectable.
- 2) Drag the sliders to set Sensitivity.

Sensitivity: The higher the value is, the more easily the detection alarm can be triggered. Its range is [0-100].

- 3) Click **Draw Region** and draw a quadrilateral in the preview window by specifying four vertexes of the detection region.

Step 7 Set the arming schedule. Refer to Chapter 11.1 Configure Arming Schedule.

Step 8 Set the linkage actions. Refer to Chapter 11.2 Configure Alarm Linkage Actions.

Step 9 Click **Apply**.

13.7 Region Exiting Detection

Purpose:

Region exiting detection function detects objects that exit from a pre-defined virtual region.

Step 1 Go to **System > Event > Smart Event**.

Step 2 Click **Region Exiting**.

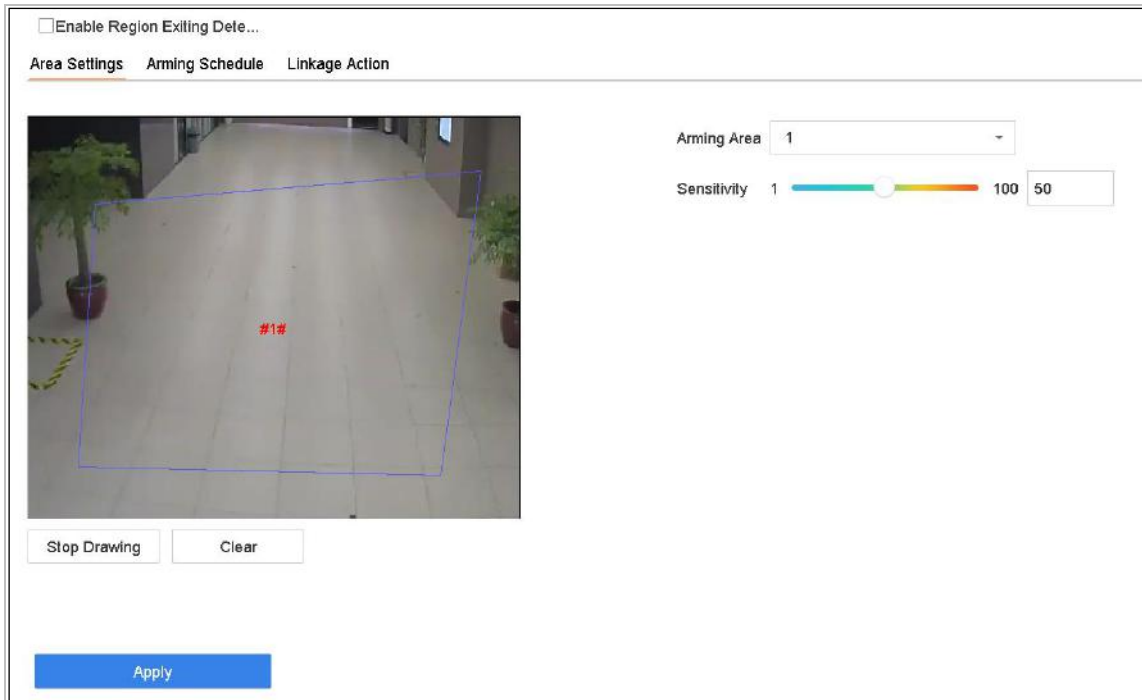

Figure 13-7 Region Exiting Detection

Step 3 Select a camera to configure.

Step 4 Check **Enable Region Exiting Detection**.

Step 5 Optionally, check **Save VCA Picture** to save the captured pictures of region exiting detection.

Step 6 Follow the steps to set the detection rules and detection areas.

- 1) Select an Arming Region to configure. Up to 4 regions are selectable.
- 2) Drag the sliders to set Sensitivity.

Sensitivity: The higher the value is, the more easily the detection alarm can be triggered. Its range is [0-100].

- 3) Click Draw Region and draw a quadrilateral in the preview window by specifying four vertexes of the detection region.

Step 7 Set the arming schedule. Refer to Chapter 11.1 Configure Arming Schedule.

Step 8 Set the linkage actions. Refer to Chapter 11.2 Configure Alarm Linkage Actions.

Step 9 Click **Apply**.

13.8 Unattended Baggage Detection

Purpose:

Unattended baggage detection function detects the objects left over in the pre-defined region such as the baggage, purse, dangerous materials, etc., and a series of actions can be taken when the alarm is triggered.

Step 1 Go to **System > Event > Smart Event**.

Step 2 Click **Unattended Baggage**.

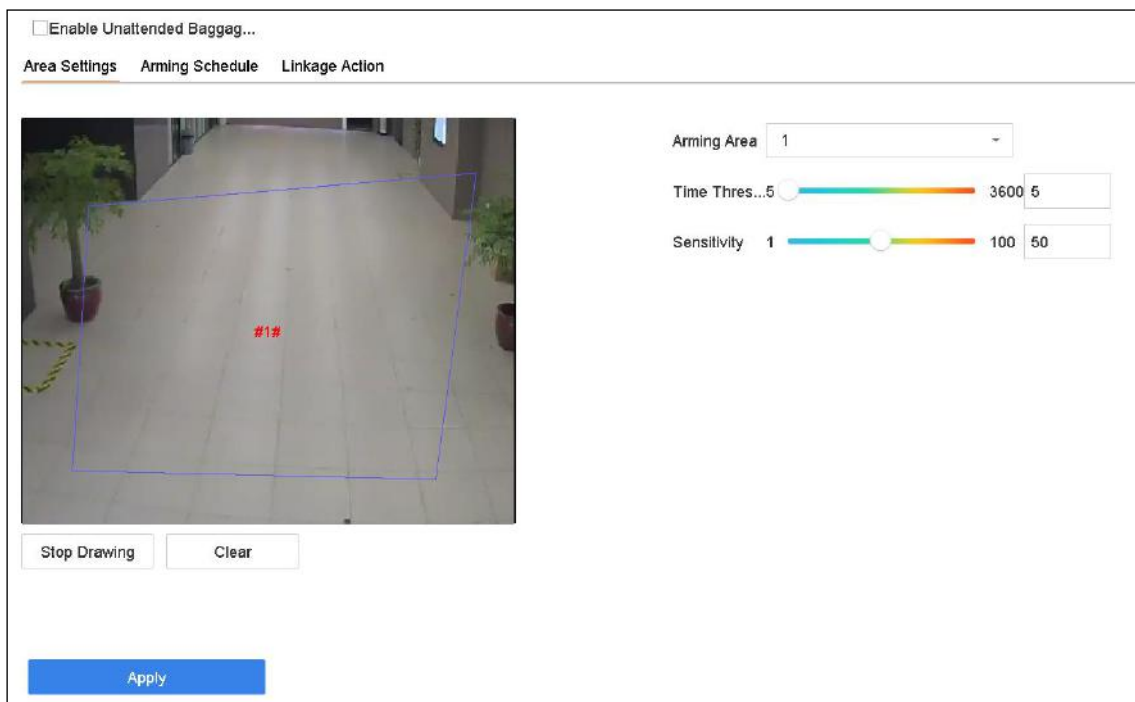

Figure 13-8 Unattended Baggage Detection

Step 3 Select a camera to configure.

Step 4 Check **Enable Unattended Baggage Detection**.

Step 5 Optionally, check **Save VCA Picture** to save the captured pictures of unattended baggage detection.

Step 6 Follow the steps to set the detection rules and detection areas.

- 1) Select an **Arming Region** to configure. Up to 4 regions are selectable.
- 2) Drag the sliders to set **Time Threshold** and **Sensitivity**.

Time Threshold: The time of the objects left over in the region. If the value is 10, alarm is triggered after the object is left and stayed in the region for 10s. Its range is [5s-20s].

Sensitivity: Similarity degree of the background image. The higher the value is, the more easily the detection alarm can be triggered.

- 3) Click **Draw Region** and draw a quadrilateral in the preview window by specifying four vertexes of the detection region.

Step 7 Set the arming schedule. Refer to Chapter 11.1 Configure Arming Schedule.

Step 8 Set the linkage actions. Refer to Chapter 11.2 Configure Alarm Linkage Actions.

Step 9 Click **Apply**.

13.9 Object Removal Detection

Purpose:

Object removal detection function detects the objects removed from the pre-defined region, such as the exhibits on display, and a series of actions can be taken when the alarm is triggered.

Step 1 Go to **System > Event > Smart Event**.

Step 2 Click **Object Removable**.

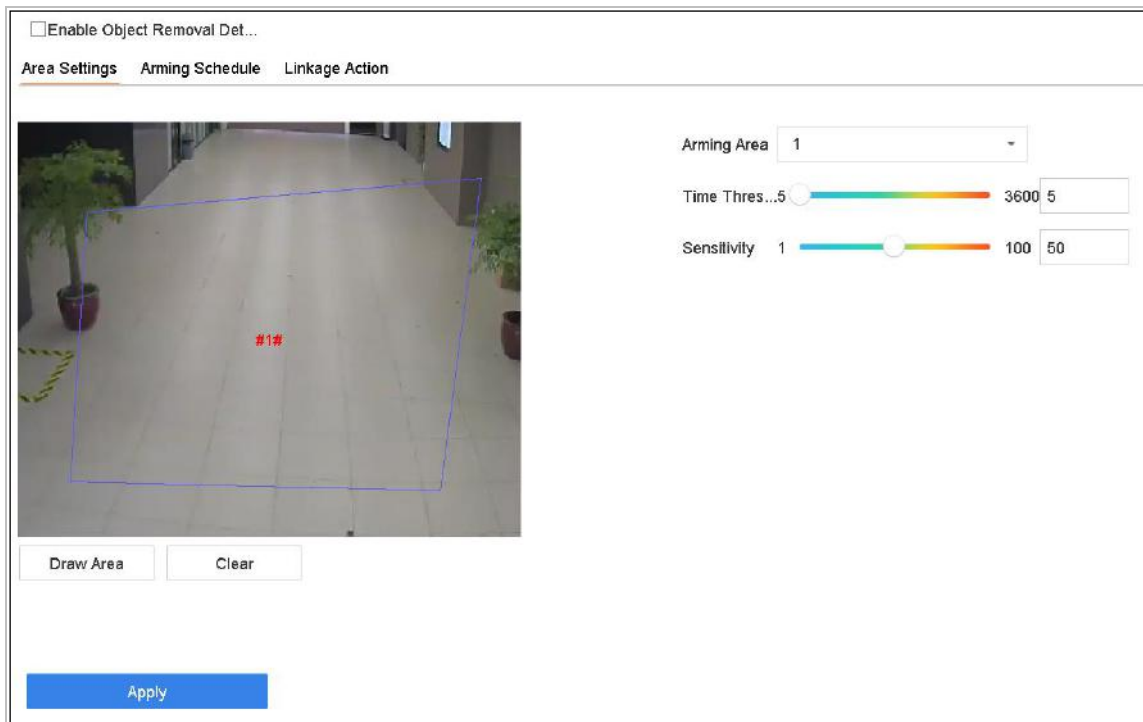

Figure 13-9 Object Removal Detection

Step 3 Select a camera to configure.

Step 4 Check **Enable Object Removable Detection**.

Step 5 Optionally, check **Save VCA Picture** to save the captured pictures of object removable detection.

Step 6 Follow the steps to set the detection rules and detection areas.

- 1) Select an Arming Region to configure. Up to 4 regions are selectable.

- 2) Drag the sliders to set Time Threshold and Sensitivity.

Time Threshold: The time of the objects removed from the region. If the value is 10, alarm is triggered after the object disappeared from the region for 10s. Its range is [5s-20s].

Sensitivity: The similarity degree of the background image. Usually, when the sensitivity is high, a very small object taken from the region can trigger the alarm.

- 3) Click **Draw Region** and draw a quadrilateral in the preview window by specifying four vertexes of the detection region.

Step 7 Set the arming schedule. Refer to Chapter 11.1 Configure Arming Schedule.

Step 8 Set the linkage actions. Refer to Chapter 11.2 Configure Alarm Linkage Actions.

Step 9 Click **Apply**.

13.10 Audio Exception Detection

Purpose:

Audio exception detection detects the abnormal sounds in the surveillance scene, such as the sudden increase/decrease of the sound intensity.

Step 1 Go to **System > Event > Smart Event**.

Step 2 Click **Audio Exception**.

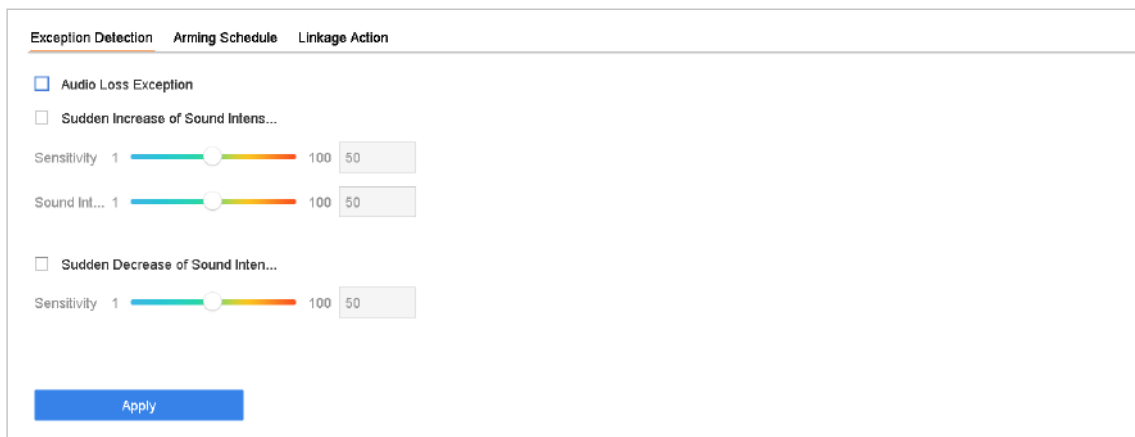

Figure 13-10 Audio Exception Detection

Step 3 Select a camera to configure.

Step 4 Optionally, check **Save VCA Picture** to save the captured pictures of audio exception detection.

Step 5 Follow the steps to set the detection rules.

- 1) Select **Exception Detection**.

- 2) Select **Audio Loss Exception**, **Sudden Increase of Sound Intensity Detection**, or **Sudden Decrease of Sound Intensity Detection**.

Audio Loss Exception: Detects the sound steep rise in the surveillance scene. You can set the detection sensitivity and threshold for sound steep rise. You need to configure its **Sensitivity** and **Sound Intensity Threshold**.

Sensitivity: The smaller the value is, the more severe the change should be to trigger the detection. Range [1-100].

Sound Intensity Threshold: It can filter the sound in the environment. The louder the environment sound, the higher the value should be. Adjust it according to the environment. Range [1-100].

Sudden Decrease of Sound Intensity Detection: Detects the sound steep drop in the surveillance scene. You need set the detection sensitivity [1-100].

Step 6 Set the arming schedule. Refer to Chapter 11.1 Configure Arming Schedule.

Step 7 Set the linkage actions. Refer to Chapter 11.2 Configure Alarm Linkage Actions.

Step 8 Click **Apply**.

13.11 Sudden Scene Change Detection

Purpose:

Scene change detection detects the change of surveillance environment affected by the external factors, such as the intentional rotation of the camera.

Step 1 Go to **System > Event > Smart Event**.

Step 2 Click **Sudden Scene Change**.

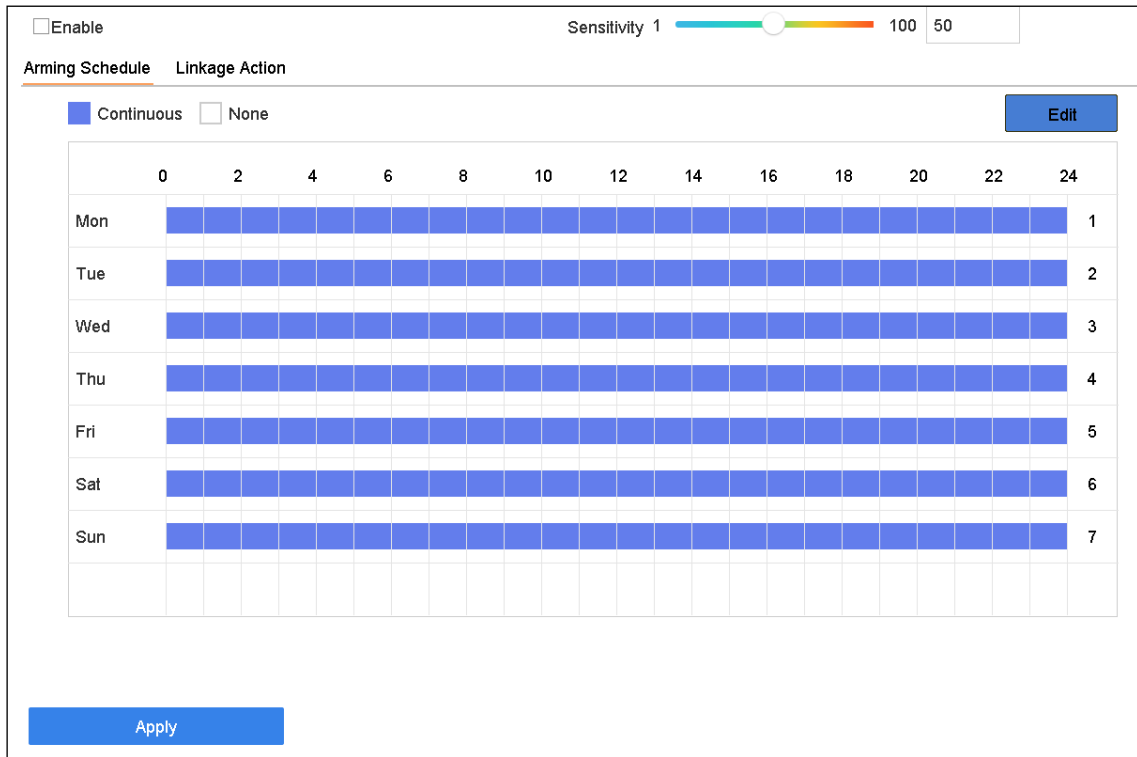

Figure 13-11 Sudden Scene Change

Step 3 Select a camera to configure.

Step 4 Check **Enable Sudden Scene Change Detection**.

Step 5 Optionally, check **Save VCA Picture** to save the captured pictures of sudden scene change detection.

Step 6 Drag the **Sensitivity** slider to set the detection sensitivity. Sensitivity range: [1-100]. The higher the value is, the more easily the change of scene can trigger the alarm.

Step 7 Set the arming schedule. Refer to Chapter 11.1 Configure Arming Schedule.

Step 8 Set the linkage actions. Refer to Chapter 11.2 Configure Alarm Linkage Actions.

Step 9 Click **Apply**.

13.12 Defocus Detection

Purpose:

The image blur caused by defocus of the lens can be detected.

Step 1 Go to **System > Event > Smart Event**.

Step 2 Click **Defocus**.

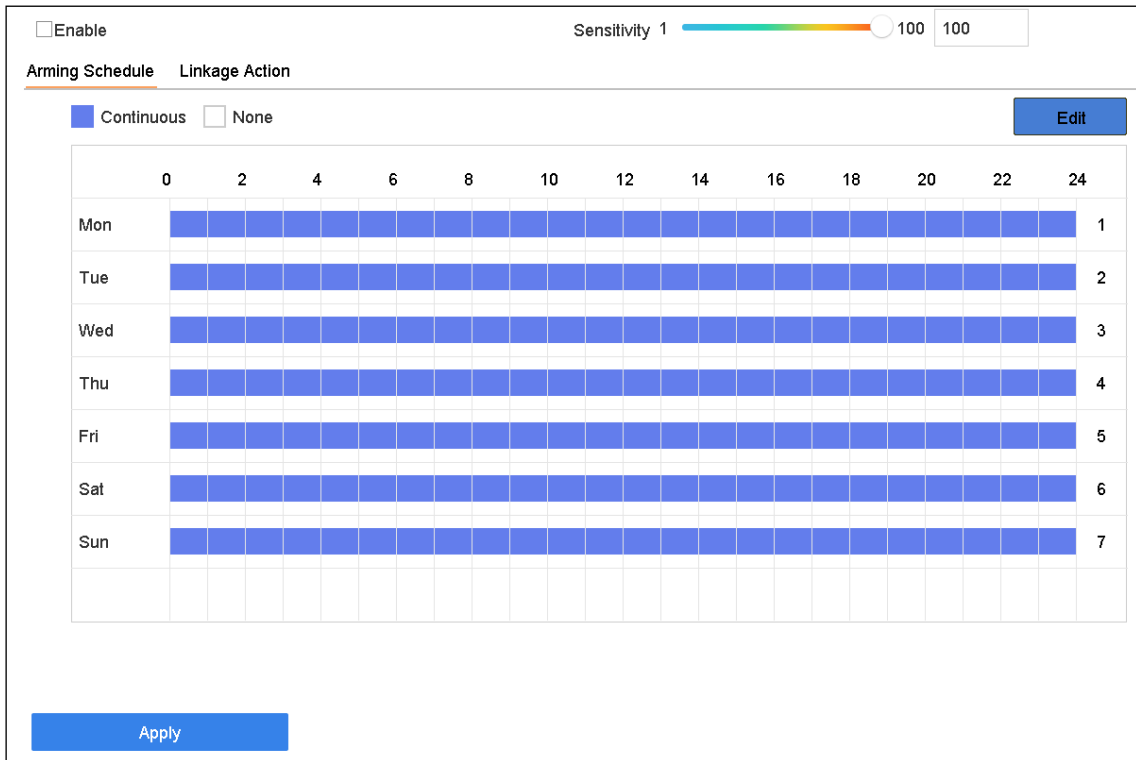

Figure 13-12 Defocus Detection

Step 3 Select a camera to configure.

Step 4 Check **Enable Defocus Detection**.

Step 5 Optionally, check **Save VCA Picture** to save the captured pictures of defocus detection.

Step 6 Drag the **Sensitivity** slider to set the detection sensitivity. Sensitivity range: [1-100]. The higher the value is, the more easily the defocus image can be detected.

Step 7 Set the arming schedule. Refer to Chapter 11.1 Configure Arming Schedule.

Step 8 Set the linkage actions. Refer to Chapter 11.2 Configure Alarm Linkage Actions.

Step 9 Click **Apply**.

13.13 PIR Alarm

Purpose:

A PIR (Passive Infrared) alarm is triggered when an intruder moves within the detector vision field. The heat energy dissipated by a person, or any other warm blooded creature such as dogs, cats, etc., can be detected.

Step 1 Go to **System > Event > Smart Event**.

Step 2 Click **PIR Alarm**.

Enable PIR Alarm

Arming Schedule
Linkage Action

Continuous
 None

Edit

| | 0 | 2 | 4 | 6 | 8 | 10 | 12 | 14 | 16 | 18 | 20 | 22 | 24 | |
|-----|---|---|---|---|---|----|----|----|----|----|----|----|----|--|
| Mon | | | | | | | | | | | | | 1 | |
| Tue | | | | | | | | | | | | | 2 | |
| Wed | | | | | | | | | | | | | 3 | |
| Thu | | | | | | | | | | | | | 4 | |
| Fri | | | | | | | | | | | | | 5 | |
| Sat | | | | | | | | | | | | | 6 | |
| Sun | | | | | | | | | | | | | 7 | |
| | | | | | | | | | | | | | | |

Apply

Figure 13-13 FIR Alarm

Step 3 Select a camera to configure.

Step 4 Check **PIR Alarm**.

Step 5 Optionally, check **Save VCA Picture** to save the captured pictures of PIR alarm.

Step 6 Set the arming schedule. Refer to Chapter 11.1 Configure Arming Schedule.

Step 7 Set the linkage actions. Refer to Chapter 11.2 Configure Alarm Linkage Actions.

Step 8 Click **Apply**.

Chapter 14 Smart Analysis

With the configured VCA detection, the device supports the smart analysis for people counting and heat map.

14.1 Face Search



The chapter is not available for iDS-7200HQHI-K/S and iDS-7200HUHI-K/S series.

Purpose:

When there are detected face picture captured and saved in HDD, you can enter the Face Search interface to search the picture and play the picture related video file according to the specified conditions.

Before you start:

Please refer to *Chapter 13.2 Face Detection* for configuring the face detection.

Step 1 Go to **Smart Analysis > Smart Search > Face Search**.

Step 2 Select the IP camera for the face search.

The screenshot shows a 'Search by Event' interface with the following fields:

- IP Channel:** [All] Camera
- Time Segment:** Today, 2017-09-19 00:00:00 - 2017-09-19 23:59:59
- Event Type:** All

Figure 14-1 Face Search

Step 3 Specify the start time and end time for search the captured face pictures or video files.

Step 4 Click **Start Search** to start searching.

Step 5 Double click on a face picture to play its related video file in the view window on the top right Play the face picture related video file.

Step 6 To export the captured face pictures to local storage device, connect the storage device to the device and click **Export**.

14.2 Human Body Search



The chapter is only available for iDS series.

Purpose:

You can search and view the matched captured human body pictures.

Step 1 Go to **Smart Analysis > Smart Search > Human Body Detection**.

Step 2 Select the camera for the human body search.

Step 3 Set search conditions.

Figure 14-2 Plate Search

Step 4 Click **Start Search**.

14.3 Vehicle Search



The chapter is only available for iDS series.

Purpose:

You can search and view the matched captured vehicle pictures.

Step 1 Go to **Smart Analysis > Smart Search > Vehicle Search**.

Step 2 Select the camera for the vehicle search.

Step 3 Set search conditions.

Figure 14-3 Plate Search

Step 4 Click **Start Search**.

14.4 People Counting

Purpose:

The Counting is used to calculate the number of people entered or left a certain configured area and form in daily/weekly/monthly/annual reports for analysis.

Step 1 Go to **Smart Analysis > Smart Search > Counting**.

Step 2 Select a camera.

Step 3 Select the report type to **Daily Report, Weekly Report, Monthly Report, or Annual Report** as you desired.

Step 4 Set the **Date** to analyze. Then it will generate the people counting graphic.

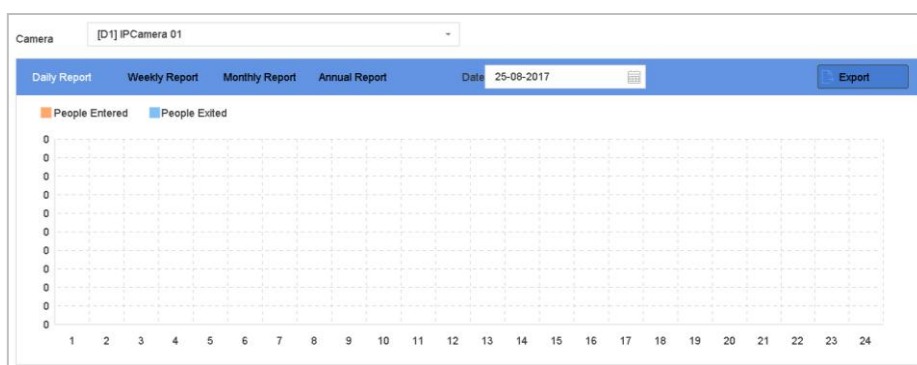

Figure 14-4 People Counting Interface

Step 5 (Optional) Click **Export** to export the report in excel format.

14.5 Heat Map

Purpose:

Heat map is a graphical representation of data. The heat map function is usually used to analyze how many people visited and stayed in a specified area.

The heat map function must be supported by the connected camera, and the corresponding configuration must be set.

Step 1 Go to **Smart Analysis > Smart Search > Heat Map**.

Step 2 Select a camera.

Step 3 Select the report type to **Daily Report, Weekly Report, Monthly Report, or Annual Report** as you desired.

Step 4 Set the **Data** to analyze.

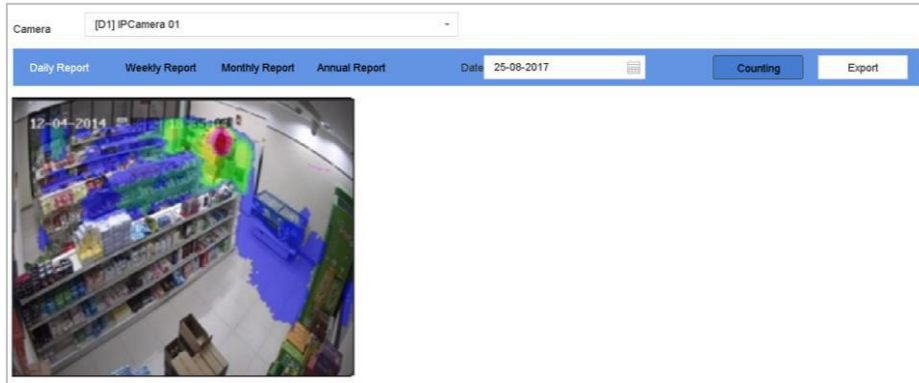

Figure 14-5 Heat Map Interface

Step 5 Click **Counting**. Then, there will generate the result graphic in different colors.

 **NOTE**

As shown in the figure above, red color block (255, 0, 0) indicates the most welcome area, and blue color block (0, 0, 255) indicates the less-popular area.

Step 6 (Optional) Click **Export** to export the statistics report in excel format.

Chapter 15 Human Body Detection



The chapter is only available for iDS-7316HUHI-K4/16S and iDS-9016HUHI-K8/16S.

15.1 Smart Analysis

15.1.1 Enable Smart Analysis

Purpose

Smart analysis function models human body pictures captured via smart events, including human body detection, line crossing detection, intrusion detection, region entrance, and region exiting, and analyzes human body appearance, including gender, age, etc. Smart analysis results are used for filtering the pictures when searching interested human body pictures.

Before you start

Check **Save VCA Pictures** for human body detection, line crossing detection, intrusion detection, region entrance, or region exiting.

Step 1 Go to **Smart Analysis > Smart Analysis > Task Configuration**.



| Task Configuration | | Engine Configuration | | | |
|---|---|---|--------------------------|----------------|---------|
|  |  |  | | | |
| <input type="checkbox"/> | Camera ... | Camera Name | Analysis Mode | Start Time | Status |
| <input checked="" type="checkbox"/> | A1 | Camera 01 | Picture Recognition -... | 2018-04-19 ... | Disable |
| <input type="checkbox"/> | A2 | Camera 02 | Picture Recognition -... | 2018-04-19 ... | Disable |
| <input type="checkbox"/> | A3 | Camera 03 | Picture Recognition -... | 2018-04-19 ... | Disable |
| <input type="checkbox"/> | A4 | Camera 04 | Picture Recognition -... | 2018-04-19 ... | Disable |
| <input type="checkbox"/> | A5 | Camera 05 | Picture Recognition -... | 2018-04-19 ... | Disable |
| <input type="checkbox"/> | A6 | Camera 06 | Picture Recognition -... | 2018-04-19 ... | Disable |
| <input type="checkbox"/> | A7 | Camera 07 | Picture Recognition -... | 2018-04-19 ... | Disable |
| <input type="checkbox"/> | A8 | Camera 08 | Picture Recognition -... | 2018-04-19 ... | Disable |
| <input type="checkbox"/> | A9 | Camera 09 | Picture Recognition -... | 2018-04-19 ... | Disable |
| <input type="checkbox"/> | A10 | Camera 10 | Picture Recognition -... | 2018-04-19 ... | Disable |
| <input type="checkbox"/> | A11 | Camera 11 | Picture Recognition -... | 2018-04-19 ... | Disable |
| <input type="checkbox"/> | A12 | Camera 12 | Picture Recognition -... | 2018-04-19 ... | Disable |
| <input type="checkbox"/> | A13 | Camera 13 | Picture Recognition -... | 2018-04-19 ... | Disable |
| <input type="checkbox"/> | A14 | Camera 14 | Picture Recognition -... | 2018-04-19 ... | Disable |

Figure 15-1 Task Configuration

Step 2 Check cameras to enable corresponding analysis mode. Ensure engine is available for the selected analysis mode.

Step 3 Enable auto analysis.

- 1) Click **Edit**.
- 2) Optionally, check **Enable** of **Display Status** and **Notify Surveillance Center**.
- 3) Set **Start Time** of video to analyze.
- 4) Click **OK**.

Step 4 Check cameras and click **Enabled** to start analyzing.



- Task status includes 3 situations: **Disabled**, **Waiting**, and **Enabled**.
 - **Disabled**: No analysis task is enabled on the camera.
 - **Waiting**: The analysis task of the camera is enabled. Device is waiting to start analyze data.
 - **Enabled**: The analysis task of the camera is enabled and device is analyzing data of the camera.

15.1.2 View Engine Status

Purpose

Smart analysis engine is applied to analyze false alarm and smart analysis task. Go to **Smart Analysis > Smart Analysis > Engine Configuration** to view the working status, usage rate, and applied channel of smart analysis engine.

15.2 Human Body Search

15.2.1 Search by Appearance

Purpose

Search human body pictures by specified human body appearance.

Search by Manually Specified Human Body Appearance

Purpose

Search human body pictures according to manually specified search conditions.

Before you start

Import human body pictures you want to search.

Step 1 Go to **Smart Analysis > Smart Search > Human Body Detection > Search by Appearance**.

The screenshot shows a web interface for searching human body pictures. It features three main filter sections:

- Channel**: A dropdown menu currently set to "[All] Camera".
- Time Segment**: A dropdown menu set to "Today", followed by two date-time pickers showing "2018-09-13 00:00" and "2018-09-13 23:59".
- Event Type**: A dropdown menu set to "Human Body Alarm".

 On the left side, there is a vertical sidebar with a button labeled "Upload Sample from Local" featuring an upward-pointing arrow icon.

Figure 15-2 Search by Appearance

Step 2 Specify search conditions.

Step 3 Click **Start Search**.

Search by Human Body Appearance Automatically Obtained from Uploaded Sample

Purpose

Search human body pictures according to human body appearance automatically obtained from uploaded sample pictures.

Before you start

Import a human body picture in USB flash drive and connect it to device.



NOTE

- When there are multiple targets existing in the same picture, up to 30 target pictures can be analyzed and displayed.
- The maximum allowed picture size is 3840*2160.
- The picture must be in jpg or jpeg format.
- The picture name (with the suffix) cannot exceed 64 characters.
- Make sure the picture you uploaded is clear and recognizable.

Step 1 Go to **Smart Analysis > Smart Search > Human Body Detection > Search by Appearance**.

Step 2 Click **Upload Sample from Local**. Device will analyze the appearance of human body in the uploaded sample picture.

Step 3 Specify **Time Segment** and **Event Type**.

Step 4 Click **Start Search**. Human body pictures match the appearance of uploaded human body picture will be listed.

15.2.2 Search by Picture

Purpose

To increase search accuracy, upload several pictures of one person to compare with captured human body pictures.

Before you start

Import human body pictures in USB flash drive and connect it to device.



NOTE

- When there are multiple targets existing in the same picture, up to 30 target pictures can be analyzed and displayed.
- The maximum allowed picture size is 3840*2160.
- The picture must be in jpg or jpeg format.
- The picture name (with the suffix) cannot exceed 64 characters.
- Make sure the picture you uploaded is clear and recognizable.

Step 1 Go to **Smart Analysis > Smart Search > Human Body Detection > Search by Picture**.

Step 2 Click **Upload Sample from Local**.

Step 3 Select a picture in USB flash drive and click **Import**.

Step 4 Select related pictures and click **Upload**.

Step 5 Specify search conditions.

- **Similarity:** Device will analyze the similarity between samples and captured human body pictures and show pictures the similarity of which are higher than the set one.

Step 6 Click **Start Search**. Search results will be arranged in similarity ascending order.

15.2.3 Add Search Result as Sample Picture

Purpose

You can add searched human body pictures as sample pictures. And then search human body pictures by the sample pictures.

Step 1 Search human body pictures.

Step 2 In search result interface, click to select a picture and click **Add to Sample**.

Step 3 Return to search condition settings interface, the selected sample will be listed.

Chapter 16 Network Settings

16.1 Configure TCP/IP Settings

Purpose

TCP/IP settings must be properly configured before operating the device over network.

Step 1 Go to **System > Network > TCP/IP**.

Figure 16-1 TCP/IP Settings

Step 2 Select **Net-Fault Tolerance** or **Multi-Address Mode** under Working Mode.

- **Net-Fault Tolerance:** The two NIC cards use the same IP address, and you can select the main NIC to LAN1 or LAN2. By this way, in case of one NIC card failure, the device will automatically enable the other standby NIC card so as to ensure the normal running of the whole system.
- **Load Balance:** By using the same IP address and two NIC cards share the load of the total bandwidth, which enables the system to provide two Gigabit network capacity.
- **Multi-address Mode:** The parameters of the two NIC cards can be configured independently. You can select LAN1 or LAN2 under Select NIC for parameter settings. You can select one NIC card as default route. And then the system is connecting with the extranet the data will be forwarded through the default route.

Step 3 Configure other IP settings as needed.



NOTE

- Check **Enable DHCP** to obtain IP settings automatically if a DHCP server is available in the network.
- Valid range of MTU value is 500 to 1500.

Step 4 Click **Apply**.

16.2 Configure Hik-Connect

Purpose

Hik-Connect provides mobile phone application and platform service to access and manage your connected devices, which enables you to get a convenient remote access to the surveillance system.

Step 1 Go to **System > Network > Advanced > Platform Access**.

Step 2 Check **Enable** to activate the function. Then the service terms will pop up.

- 1) Enter the verification code in **Verification Code**.
- 2) Scan the QR code to read the service terms and privacy statement.
- 3) Check **The Hik-Connect service will require internet access. Please read Service Terms and Privacy Statement before enabling the service** if you agree the service terms and privacy statement.
- 4) Click **OK** to save the settings.

NOTE

- Hik-Connect is disabled by default.
- The verification code is empty by default. It must contain 6 to 12 letters or numbers, and it is case sensitive.

Step 3 (Optional) Check **Custom** to enter the server address as your desire.

Step 4 (Optional) Check **Enable Stream Encryption**, verification code is required for remote access and live view.

Step 5 (Optional) Click **Unbind** if the device requires to unbind with the current Hik-Connect account.

Step 6 Click **Apply**.

What to do next:

After configuration, you can access and manage your devices through Hik-Connect app or website.

16.3 Configure DDNS

Purpose

You can set Dynamic DNS service for network access. Different DDNS modes are available: **DynDNS**, **PeanutHull**, and **NO-IP**.

Before You Start

You must register DynDNS, PeanutHull and NO-IP services with your ISP before configuring DDNS settings.

Step 1 Go to **System > Network > TCP/IP > DDNS**.

Step 2 Check **Enable**.

Step 3 Select **DynDNS** under **DDNS Type**.



NOTE

PeanutHull and NO-IP are also available under DDNS Type, and required information should be entered accordingly.

Step 4 Enter **Server Address** for **DynDNS** (i.e. members.dyndns.org).

Step 5 Under **Device Domain Name**, enter the domain name obtained from the DynDNS website.

Step 6 Enter the **User Name** and **Password** registered in the DynDNS website.

The screenshot shows the DDNS configuration interface. At the top, there are tabs for TCP/IP, DDNS (which is selected), PPPoE, NTP, and NAT. Below the tabs, there is an 'Enable' checkbox that is checked. The 'DDNS Type' is set to 'DynDNS' in a dropdown menu. The 'Server Address' is 'member.dyndns.org', the 'Device Domain Name' is '1233dyndns.com', the 'User Name' is 'test', and the 'Password' is masked with asterisks. The 'Status' section indicates 'DDNS is disabled.' At the bottom, there is a blue 'Apply' button.

Figure 16-2 DDNS Settings

Step 7 Click **Apply**.

16.4 Configure PPPoE

If the device is connected to Internet through PPPoE, you need to configure user name and password accordingly under **System > Network > TCP/IP > PPPoE**.



Contact your Internet service provider for details about PPPoE service.

16.5 Configure NTP

Purpose

Connection to a network time protocol (NTP) server can be configured on your device to ensure the accuracy of system date and time.

Step 1 Go to **System > Network > TCP/IP > NTP**.

 A screenshot of a web-based configuration interface for NTP settings. At the top, there are five tabs: TCP/IP, DDNS, PPPoE, NTP (which is selected and underlined), and NAT. Below the tabs, there are four rows of settings. The first row is 'Enable' with a checked checkbox. The second row is 'Interval (min)' with a text input field containing '180'. The third row is 'NTP Server' with a text input field containing 'au.pool.ntp.org'. The fourth row is 'NTP Port' with a text input field containing '123'. At the bottom of the form is a blue button labeled 'Apply'.

Figure 16-3 NTP Settings

Step 2 Check **Enable**.

Step 3 Configure NTP settings as need.

- **Interval (min)**: Time interval between two time synchronizations with NTP server.
- **NTP Server**: IP address of the NTP server.
- **NTP Port**: Port of the NTP server.

Step 4 Click **Apply**.

16.6 Configure SNMP

Purpose

You can configure SNMP settings to get device status and parameter information.

Before You Start

Download the SNMP software to receive device information via SNMP port. By setting the trap address and port, the device is allowed to send alarm event and exception message to the surveillance center.

Step 1 Go to **System > Network > Advanced > SNMP**.

| SNMP | Email | More Settings |
|-----------------|--------------------------|---------------|
| Enable | <input type="checkbox"/> | |
| SNMP Version | V2 | |
| SNMP Port | 161 | |
| Read Community | public | |
| Write Community | private | |
| Trap Address | | |
| Trap Port | 162 | |

Apply

Figure 16-4 SNMP Settings

Step 2 Check **Enable**. A message box will pop up to prompt possible security risk and click **Yes** to continue.

Step 3 Configure the SNMP settings as needed.

- **Trap Address:** IP address of the SNMP host.
- **Trap Port:** Port of the SNMP host.

Step 4 Click **Apply**.

16.7 Configure Email

Purpose

The system can send an Email to designated users when a specified event occurs, such as an alarm or motion event is detected, or the administrator password is changed, etc.

Before You Start

The device must be connected to a local area network (LAN) that contains an SMTP mail server. The network must be connected to either an intranet or the Internet depending on the location of the e-mail accounts to send notification.

Step 1 Go to **System > Network > Advanced > Email**.

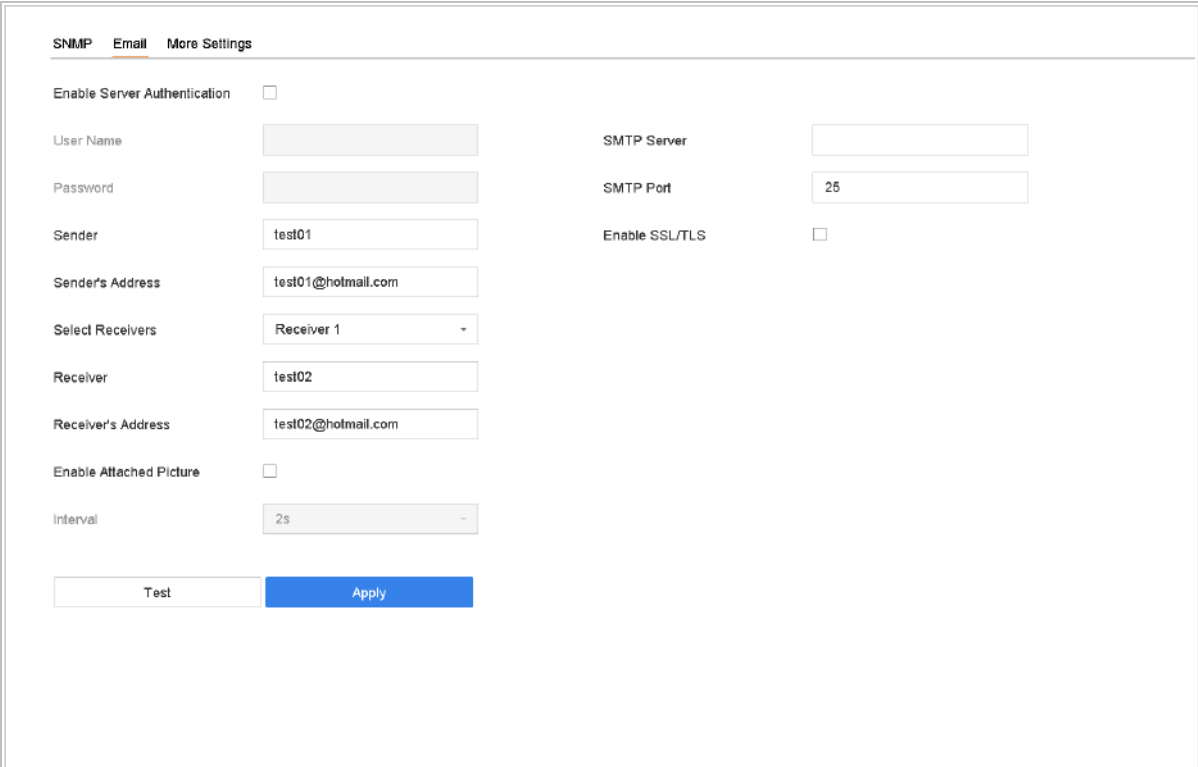

The screenshot shows the 'Email' settings page with the following fields and options:

- Enable Server Authentication:**
- User Name:** [Empty text box]
- Password:** [Empty text box]
- SMTP Server:** [Empty text box]
- SMTP Port:** [25]
- Sender:** [test01]
- Enable SSL/TLS:**
- Sender's Address:** [test01@hotmail.com]
- Select Receivers:** [Receiver 1]
- Receiver:** [test02]
- Receiver's Address:** [test02@hotmail.com]
- Enable Attached Picture:**
- Interval:** [2s]

At the bottom, there are two buttons: 'Test' and 'Apply'.

Figure 16-5 Email Settings

Step 2 Configure the following Email settings.

- **Enable Server Authentication:** Check to enable the function if the SMTP server requires user authentication and enter user name and password accordingly.
- **SMTP Server:** The IP address of SMTP Server or host name (e.g., smtp.263xmail.com).
- **SMTP Port:** The SMTP port. The default TCP/IP port used for SMTP is 25.
- **Enable SSL/TLS:** Check to enable SSL/TLS if required by the SMTP server.
- **Sender:** The name of the sender.
- **Sender's Address:** Sender's Address.
- **Select Receivers:** Select the receiver. Up to 3 receivers can be configured.

- **Receiver:** The name of the receiver.
- **Receiver's Address:** The Email address of user to be notified.
- **Enable Attached Picture:** Check to enable the function if you want to send email with attached alarm images. The interval is the time between two adjacent alarm images.

Step 3 Click **Apply**.

Step 4 (Optional) Click **Test** to send a test email.

16.8 Configure Ports

You can configure different types of ports to enable relevant functions.

Go to **System > Network > Advanced > More Settings** and configure port settings as needed.

- **Alarm Host IP/Port:** With a remote alarm host configured, the device will send the alarm event or exception message to the host when an alarm is triggered. The remote alarm host must have the client management system (CMS) software installed.

The **Alarm Host IP** refers to the IP address of the remote PC on which the CMS software (e.g., iVMS-4200) is installed, and the **Alarm Host Port** (7200 by default) must be the same as the alarm monitoring port configured in the software.

- **Server Port:** Server port (8000 by default) should be configured for remote client software access and its valid range is 2000 to 65535.
- **HTTP Port:** HTTP port (80 by default) should be configured for remote web browser access.
- **Multicast IP:** Multicast can be configured to enable live view for cameras that exceed the maximum number allowed through network. A multicast IP address covers Class-D IP ranging from 224.0.0.0 to 239.255.255.255 and it is recommended to use the IP address ranging from 239.252.0.0 to 239.255.255.255.

When adding a device to the CMS software, the multicast address must be the same as that of the device.

- **RTSP Port:** RTSP (Real Time Streaming Protocol) is a network control protocol designed for use in entertainment and communications systems to control streaming media servers. The port is 554 by default.
- **Output Bandwidth Limit:** You can check the checkbox to enable output bandwidth limit.
- **Output Bandwidth:** After enable the output bandwidth limit, input the output bandwidth.

NOTE

- The output bandwidth limit is used for the remote live view and playback.
- The default output bandwidth is the maximum limit.

| Email | Platform Access | More Settings |
|----------------|--------------------------|-----------------------------------|
| Alarm Host IP | | <input type="text"/> |
| Alarm Host ... | | <input type="text" value="0"/> |
| Server Port | | <input type="text" value="8000"/> |
| HTTP Port | | <input type="text" value="80"/> |
| Multicast IP | | <input type="text"/> |
| RTSP Port | | <input type="text" value="554"/> |
| Output Ban... | <input type="checkbox"/> | |
| Output Ban... | | <input type="text" value="2"/> |

Figure 16-6 Port Settings

Chapter 17 System Maintenance

17.1 Storage Device Maintenance

17.1.1 Configure Disk Clone

Purpose:

Select the HDDs to clone to eSATA HDD.

Before you start:

Connect an eSATA disk to the device.

Step 1 Go to **Maintenance > HDD Operation > HDD Clone**.

| Label | Capacity | Status | Property | Type | Free Space | Group |
|-----------------------------|-----------|--------|----------|-------|------------|-------|
| <input type="checkbox"/> 1 | 1863.02GB | Normal | RAW | Local | 1858.00GB | 1 |
| <input type="checkbox"/> 2 | 2794.52GB | Normal | RAW | Local | 2794.00GB | 1 |
| <input type="checkbox"/> 5 | 1863.02GB | Normal | RAW | Local | 1862.00GB | 1 |
| <input type="checkbox"/> 9 | 2794.52GB | Normal | RAW | Local | 2794.00GB | 1 |
| <input type="checkbox"/> 10 | 1863.02GB | Normal | RAW | Local | 1862.00GB | 1 |

Clone Destination

eSATA: eSATA1 Refresh

Capacity: 2794.52GB Clone

Figure 17-1 HDD Clone

Step 2 Check the HDD to clone. The capacity of selected HDD must match the capacity of clone destination.

Step 3 Click **Clone**.

Step 4 Click **Yes** on popup message box to continue clone.

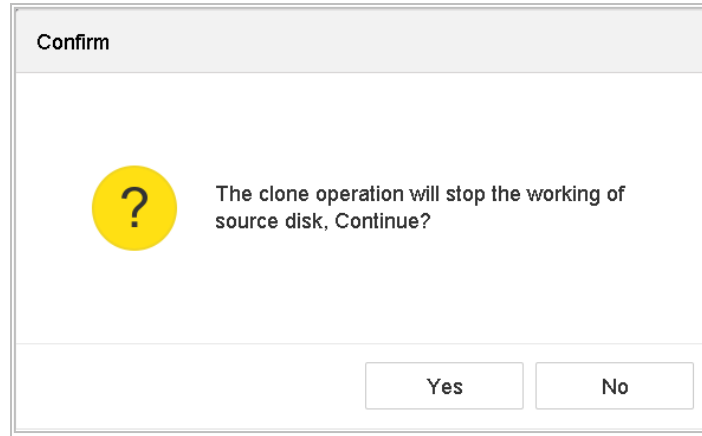

Figure 17-2 Message Box

17.1.2 S.M.A.R.T Detection

Purpose:

The device provides HDD detection function including S.M.A.R.T. and Bad Sector Detection technique. The S.M.A.R.T. (Self-Monitoring, Analysis and Reporting Technology) is a monitoring system for HDD to detect and report on various indicators of reliability in the hopes of anticipating failures.

Step 1 Go to **Maintenance > HDD Operation > S.M.A.R.T.**

Step 2 Select the HDD to view its S.M.A.R.T information list.

Step 3 Select the self-test types as **Short Test, Expanded Test** or **Conveyance Test**.

Step 4 Click **Self-Test** to start the S.M.A.R.T. HDD self-evaluation.

Step 5 The related information of the S.M.A.R.T. is shown on the interface. You can check the HDD status.

Continue to use this disk when self-evaluation is failed.

HDD No.

Self-Test Type

Temperature... Self-Evaluation

Working Time... All-Evaluation

S.M.A.R.T Infor

| ID | Attribute Name | Status | Flags | Threshold | Value | Worst | Raw Value |
|-----|------------------------|--------|-------|-----------|-------|-------|-----------|
| 0x1 | Raw Read Error R... | OK | 2f | 51 | 200 | 200 | 8 |
| 0x3 | Spin Up Time | OK | 27 | 21 | 113 | 107 | 7316 |
| 0x4 | Start/Stop Count | OK | 32 | 0 | 98 | 98 | 2657 |
| 0x5 | Reallocated Sector... | OK | 33 | 140 | 200 | 200 | 0 |
| 0x7 | Seek Error Rate | OK | 2e | 0 | 200 | 200 | 0 |
| 0x9 | Power-on Hours C... | OK | 32 | 0 | 98 | 98 | 9369 |
| 0xa | Spin Up Retry Count | OK | 32 | 0 | 100 | 100 | 0 |
| 0xb | Calibration Retry C... | OK | 32 | 0 | 100 | 100 | 0 |

Figure 17-3 S.M.A.R.T Settings Interface

 **NOTE**

If you want to use the HDD even when the S.M.A.R.T. checking is failed, you can check **Continue to use the disk when self-evaluation is failed**.

17.1.3 Bad Sector Detection

Step 1 Go to **Maintenance > HDD Operation > Bad Sector Detection**.

Step 2 Select the HDD No. in the dropdown list you want to configure.

Step 3 Select **All Detection** or **Key Area Detection** as the detection type.

Step 4 Click **Self-Test** to start the detection.

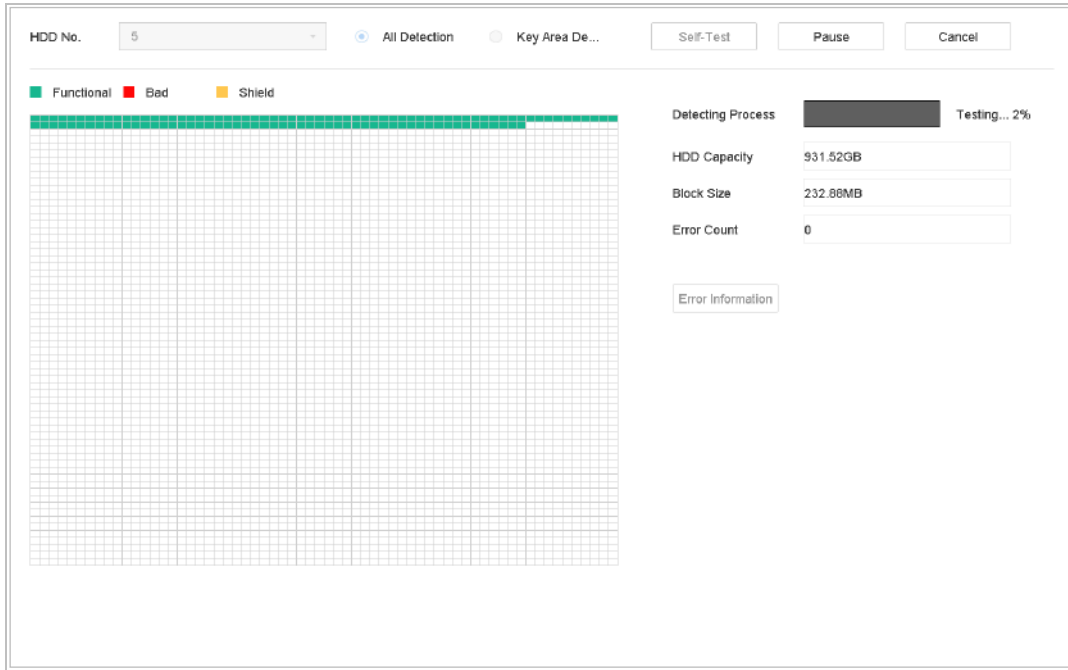

Figure 17-4 Bad Sector Detection

- You can also pause/resume or cancel the detection.
- After testing completed, click **Error information** to see the detailed damage information.

17.1.4 HDD Health Detection

Purpose:

You can view the health status of Seagate HDD that generated after October 1th, 2017 and provides capacity ranges from 4 TB to 8 TB. The function helps you to troubleshoot HDD problems. Compared with S.M.A.R.T function, health detection shows HDD status with more details.

Step 1 Go to **Maintenance > HDD Operation > Health Detection**.

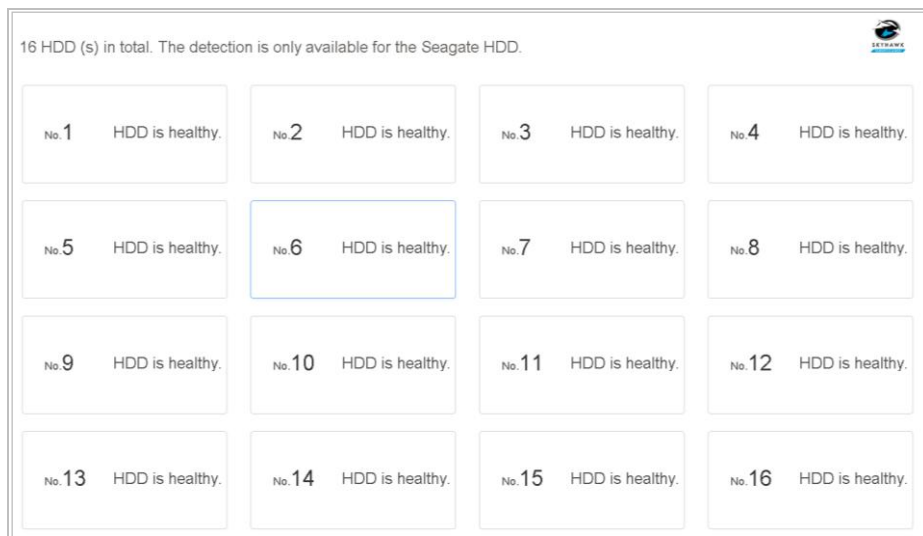

Figure 17-5 Health Detection

Step 2 Click a HDD to view details.

17.2 Search & Export Log Files

Purpose:

The operation, alarm, exception and information of the device can be stored in log files, which can be viewed and exported at any time.

17.2.1 Search the Log Files

Step 1 Go to **Maintenance > Log Information**.

Step 2 Set the log search conditions.

Step 3 Click **Search** to start search log files.

The matched log files will be displayed in the list shown below.

| No. | Major Type | Time | Minor Type | Parameter | Play | Details |
|-----|-------------|---------------------|-----------------------|-----------|------|---------|
| 1 | Exception | 2017-10-09 00:01:53 | HDD Error | N/A | — | ⌵ |
| 2 | Operation | 2017-10-09 00:01:53 | Abnormal Shutdown | N/A | — | ⌵ |
| 3 | Operation | 2017-10-09 00:01:54 | Power On | N/A | — | ⌵ |
| 4 | Information | 2017-10-09 00:01:54 | Local HDD Information | N/A | — | ⌵ |
| 5 | Exception | 2017-10-09 00:04:01 | HDD Error | N/A | — | ⌵ |
| 6 | Operation | 2017-10-09 00:04:01 | Abnormal Shutdown | N/A | — | ⌵ |
| 7 | Operation | 2017-10-09 00:04:02 | Power On | N/A | — | ⌵ |
| 8 | Information | 2017-10-09 00:04:02 | Local HDD Information | N/A | — | ⌵ |
| 9 | Exception | 2017-10-09 00:06:09 | HDD Error | N/A | — | ⌵ |
| 10 | Operation | 2017-10-09 00:06:09 | Abnormal Shutdown | N/A | — | ⌵ |
| 11 | Information | 2017-10-09 00:06:10 | Local HDD Information | N/A | — | ⌵ |
| 12 | Operation | 2017-10-09 00:06:10 | Power On | N/A | — | ⌵ |
| 13 | Exception | 2017-10-09 00:08:18 | HDD Error | N/A | — | ⌵ |
| 14 | Operation | 2017-10-09 00:08:18 | Abnormal Shutdown | N/A | — | ⌵ |
| 15 | Operation | 2017-10-09 00:08:19 | Power On | N/A | — | ⌵ |
| 16 | Information | 2017-10-09 00:08:19 | Local HDD Information | N/A | — | ⌵ |
| 17 | Exception | 2017-10-09 00:12:01 | HDD Error | N/A | — | ⌵ |
| 18 | Operation | 2017-10-09 00:12:01 | Abnormal Shutdown | N/A | — | ⌵ |

Total: 2000 P: 1/20

Figure 17-6 Log Search Results

NOTE

Up to 2000 log files can be displayed each time.

Related Operation:

- Click  or double click it to view its detailed information.

- Click  to view the related video file.

17.2.2 Export the Log Files

Before You Start:

Connect a storage device to your device.

Step 1 Search the log files. Refer to Chapter 17.2.1 Search the Log Files.

Step 2 Select the log files you want to export, and click **Export**.

Or you can click **Export ALL** on the Log Search interface to export all the system logs to the storage device.

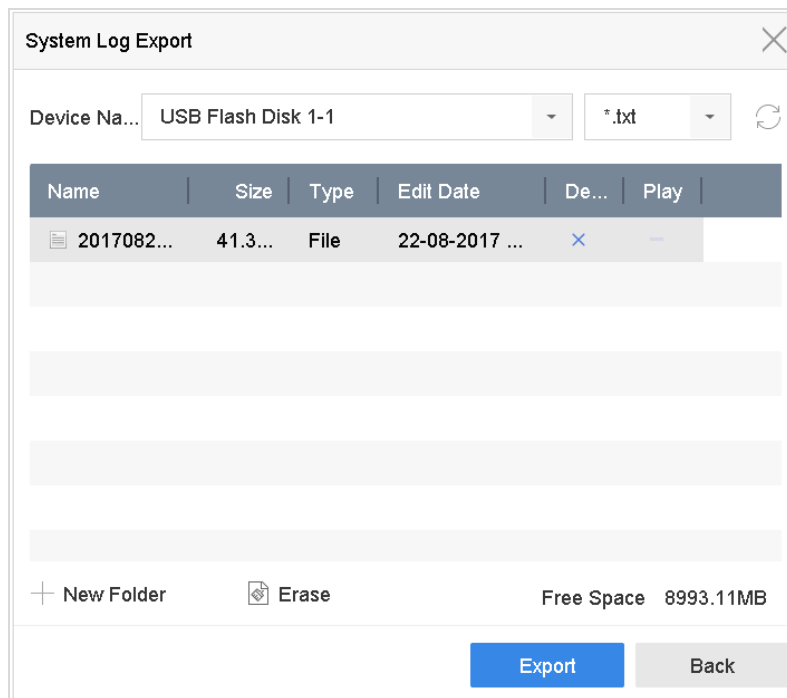

Figure 17-7 Export Log Files

Step 3 Select the storage device from the dropdown list of **Device Name**.

Step 4 Select the format of the log files to be exported. Up to 15 formats are selectable.

Step 5 Click **Export** to export the log files to the selected storage device.

Related Operation:

- Click **New Folder** to create new folder in the storage device.
- Click **Format** to format the storage device before log export.

17.3 Import/Export IP Camera Configuration Files

Purpose:

The information of added IP camera can be generated into an excel file and exported to the local device for backup, including the IP address, manage port, password of admin, etc. And the exported file can be edited on your PC, like adding or deleting the content, and copy the setting to other devices by importing the excel file to it.

Before You Start:

Connect a storage device to your device. For importing the configuration file, the storage device must be with the file.

Step 1 Go to **Camera > IP Camera Import/Export**.

Step 2 Click the **IP Camera Import/Export** tab, and the content of detected plugged external device appears.

Step 3 Export or import the IP camera configuration files.

- Click **Export** to export configuration files to the selected local backup device.
- To import a configuration file, select the file from the selected backup device and click the **Import** button.



After the importing process is completed, you must reboot the device to activate the settings.

17.4 Import/Export Device Configuration Files

Purpose:

The configuration files of the device can be exported to local device for backup; and the configuration files of one device can be imported to multiple devices if they are to be configured with the same parameters.

Connect a storage device to your device. For importing the configuration file, the storage device must be with the file.

Before You Start:

Connect a storage device to your device. For importing the configuration file, the storage device must be with the file.

Step 1 Go to **Maintenance > Import/Export**

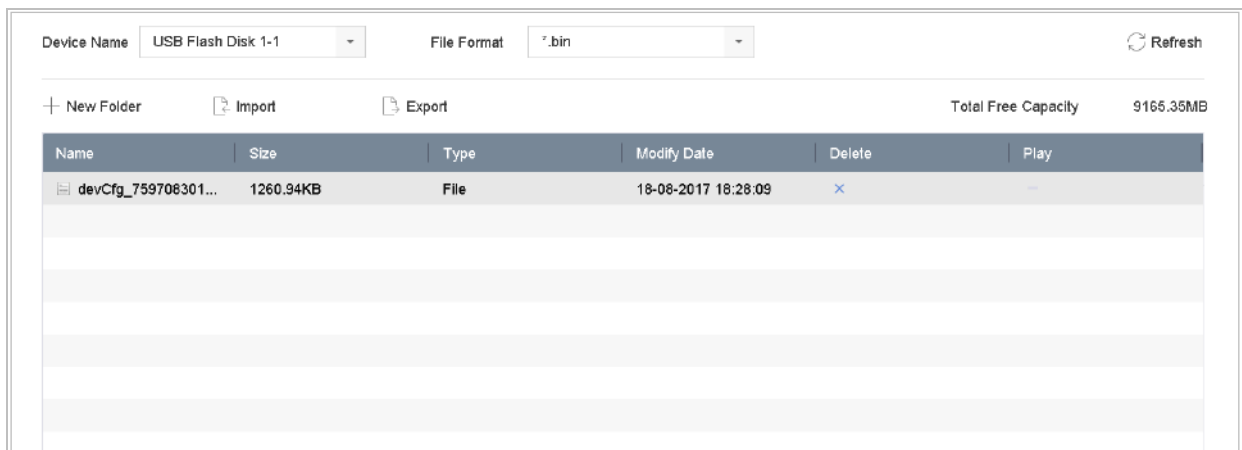

Figure 17-8 Import/Export Config File

Step 2 Export or import the device configuration files.

- Click **Export** to export configuration files to the selected local backup device.
- To import a configuration file, select the file from the selected backup device and click **Import**.

NOTE

After having finished the import of configuration files, the device will reboot automatically.

17.5 Upgrade System

Purpose:

The firmware on your device can be upgraded by local backup device or remote FTP server.

17.5.1 Upgrade by Local Backup Device

Before You Start:

Connect your device with a local storage device with update firmware file.

Step 1 Go to **Maintenance > Upgrade > Local Upgrade** to enter the local upgrade interface.

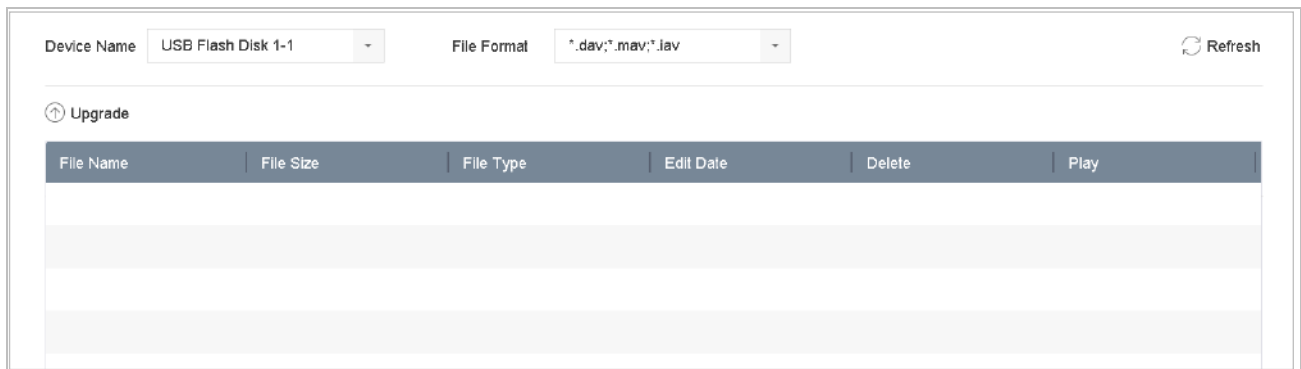

Figure 17-9 Local Upgrade Interface

Step 2 Select the update file from the storage device.

Step 3 Click **Upgrade** to start upgrading.

Step 4 After the upgrading is complete, the device will reboot automatically to activate the new firmware.

17.5.2 Upgrade by FTP

Before you start:

Ensure the network connection of the PC (running FTP server) and the device is valid and correct. Run the FTP server on the PC and copy the firmware into the corresponding directory of your PC.

Step 1 Go to **Maintenance > Upgrade > FTP** to enter the local upgrade interface.

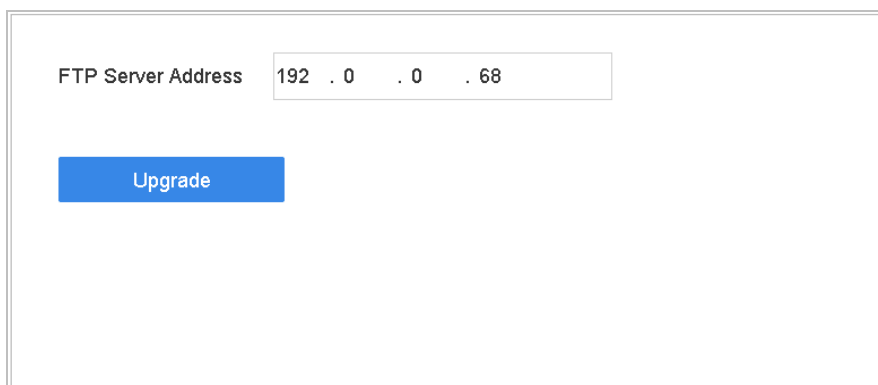

Figure 17-10 FTP Upgrade Interface

Step 2 Enter IP address of **FTP Server Address**.

Step 3 Click **Upgrade** to start upgrading.

Step 4 After the upgrading is complete, reboot the device to activate the new firmware.

17.5.3 Upgrade by Hik-Connect

After logging the device into Hik-Connect, the device would periodically check for the latest firmware from Hik-Connect. If an upgrade firmware is available, the device will notify you when you log in. You can also manually check for the latest firmware.

Before You Start:

Ensure the device has successfully connected to Hik-Connect, and it requires to install at least one read-write HDD for firmware downloading.

Step 1 Go to **Maintenance > Upgrade > Online Upgrade**.

Step 2 Click **Check Upgrade** to manually check and download the latest firmware from Hik-Connect.

NOTE

The device will automatically check for the latest firmware every 24 hours. If it detects available upgrade firmware, the device will notify you when you log in.

Step 3 (Optional) You can switch on **Download Latest Package Automatically** to automatically download the latest firmware package.

Step 4 Click **Upgrade Now**.

17.6 Upgrade Camera

Purpose

You can upgrade multiple connected analog cameras supporting Turbo HD or AHD signal simultaneously with DVR.

Step 1 Go to **Maintenance > Upgrade > Camera Upgrade**.

Step 2 Check the analog camera(s) for upgrading.



The analog camera must support Turbo HD or AHD signal.

Step 3 Select the update file from the backup device.

Step 4 Click **Upgrade** to start upgrading.

17.7 Restore Default Settings

Step 1 Go to **Maintenance > Default**.

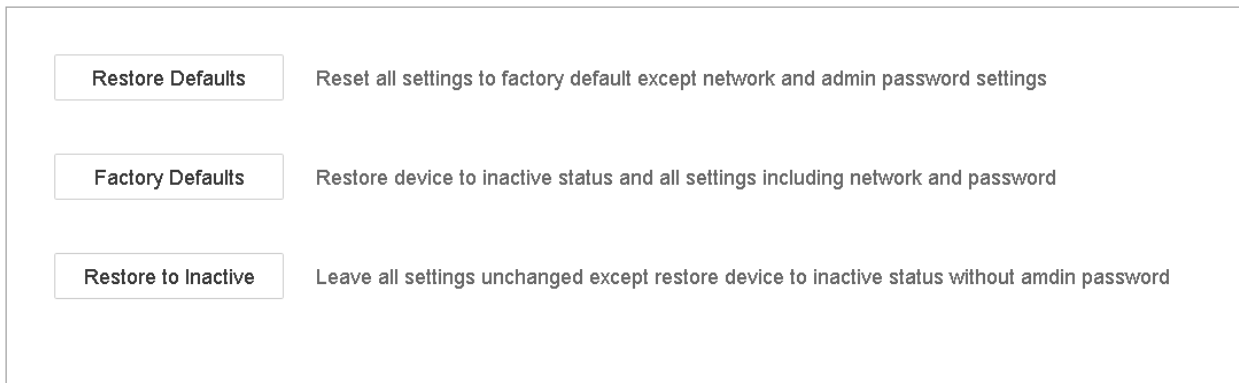

Figure 17-11 Restore Defaults

Step 2 Select the restoring type from the following three options.

Restore Defaults: Restore all parameters, except the network (including IP address, subnet mask, gateway, MTU, NIC working mode, default route, server port, etc.) and user account parameters, to the factory default settings.

Factory Defaults: Restore all parameters to the factory default settings.

Restore to Inactive: Restore the device to the inactive status.



The device will reboot automatically after restoring to the default settings.

17.8 System Service

17.8.1 Network Security Settings

Disable SADP Services

Purpose

You can disable SADP service to enhance the access security, e.g., when you are in the untrusted network environment.

Step 1 Go to **System > System Service > System Service**.

Step 2 Uncheck **Enable SADP** to disable the service.

HTTP

You can choose to disable the HTTP, or set the HTTP authentication when it is enabled as demand to enhance the access security.



NOTE

By default, the HTTP service is enabled.

Set HTTP Authentication

Purpose

If you need to enable the HTTP service, you can set the HTTP authentication to enhance the access security.

Step 1 Go to **System > System Service > System Service**.

 A screenshot of a web interface showing two settings. The first is 'Enable HTTP' with a checked checkbox. The second is 'HTTP Authentication Type' with a dropdown menu showing 'digest' selected.

| | |
|--------------------------|-------------------------------------|
| Enable HTTP | <input checked="" type="checkbox"/> |
| HTTP Authentication Type | digest |

Figure 17-12 HTTP Authentication

Step 2 Check the **Enable HTTP** to enable the HTTP service.

Step 3 Select the **digest** as the **HTTP Authentication** in the drop-down list.

Step 4 Click **Save** to save the settings.



NOTE

Two authentication types are selectable: **digest** and **digest/basic**. For security reasons, it is recommended to select digest as the authentication type.

Disable HTTP

Purpose

The admin user account can disable the HTTP service from the GUI or the web browser.

After the HTTP is disabled, all its related services, including the ISAPI, Onvif and Gennetc, will terminate as well.

Step 5 Go to **System > System Service> System Service**.

Step 6 Uncheck the **Enable HTTP** to disable the HTTP service.

RTSP Authentication

Purpose

You can specifically secure the stream data of live view by setting the RTSP authentication.

Step 1 Go to **System > System Service> System Service**.



The screenshot shows a configuration panel for RTSP authentication. It contains two main elements: a checkbox labeled 'Enable RTSP' which is checked with a blue checkmark, and a dropdown menu labeled 'RTSP Authentication Type' which currently displays 'digest' and has a small downward arrow on its right side.

Figure 17-13 RTSP Authentication

Step 2 Select the authentication type.

NOTE

Two authentication types are selectable: **digest** and **digest/basic**. If you select **digest**, as the RTSP authentication, only the request with digest authentication can access the video stream by the RTSP protocol via the IP address. For security reasons, it is recommended to select digest as the authentication type.

Step 3 Click **Save** to save the settings.

17.8.2 Managing ONVIF User Accounts

Purpose

For the third-party camera connection to the device via ONVIF, you can enable ONVIF function and manage the user accounts.

Step 1 Go to **System > System Service > ONVIF**.

Step 2 Check **Enable ONVIF** to enable the ONVIF access management.

Step 3 Click **Add** to enter the Add User interface.

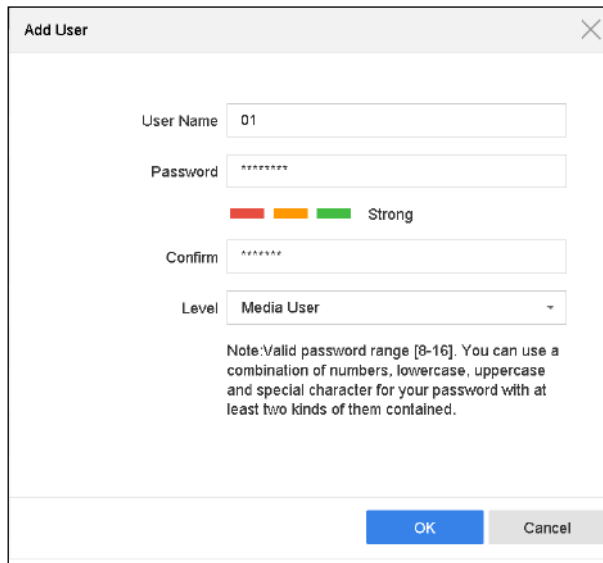

Figure 17-14 Add User

Step 4 Edit the user name, and enter the strong password.

Step 5 Select the user level to **Media User**, **Operator** and **Admin**.

Step 6 Click **OK** to save the settings.

Result:

The added user accounts have the permission to connect other devices to the device via ONVIF protocol.



ONVIF protocol is disabled by default.

17.8.3 Managing IP Camera Activation

Purpose:

When you activate the device for the first-time access, you can set the activation password for the IP camera (s) as well. Refer to Chapter 2.2 Activate the Device. And you can also manage the password to enhance the security.

Step 1 Go to **System > System Service > IP Camera Activation**.

Step 2 Check the **Change Password** to enable the permission.

Step 3 Enter the admin password of the device to obtain the permission.

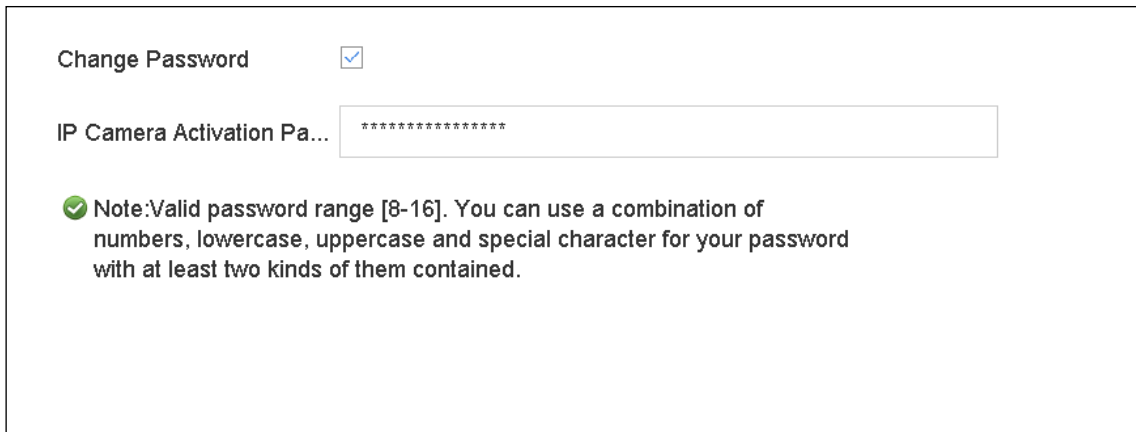

Change Password

IP Camera Activation Pa...

✔ Note: Valid password range [8-16]. You can use a combination of numbers, lowercase, uppercase and special character for your password with at least two kinds of them contained.

Figure 17-15 Change IP Camera Activation Password

Step 4 In the text field of the **IP Camera Activation Password**, enter the new strong password for the cameras.

Step 5 Click **Apply** to have the following pop-up attention box.

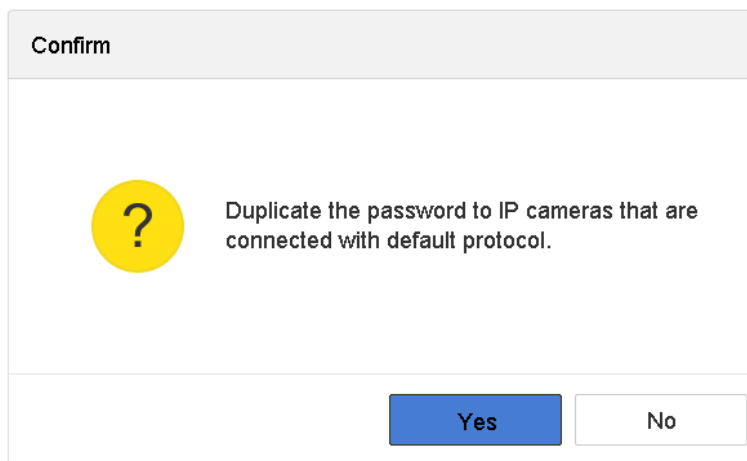

Confirm

?

Duplicate the password to IP cameras that are connected with default protocol.

Yes No

Figure 17-16 Attention

Step 6 Click **Yes** to duplicate the current password to the IP cameras which are connected with the default protocol.

Chapter 18 General System Settings

18.1 Configure General Settings

Purpose:

You can configure the BNC output standard, VGA output resolution, mouse pointer speed through the System > General interface.

Step 1 Go to **System > General**.

The screenshot displays the 'General Settings' interface with the following configurations:

- Language:** English
- Time Zone:** (GMT+08:00) Beijing, Urumc
- Date Format:** DD-MM-YYYY
- System Date:** 22-08-2017
- System Time:** 11:34:09
- Device Name:** Network Video Recorder
- Device No.:** 255
- Auto Log out:** Never
- Enable Wizard:**
- Enable Password:**
- VGA/HDMI Resolution:** 1920*1080/60HZ(1080P)
- VGA2/HDMI2 Resolution:** 1920*1080/60HZ(1080P)
- Mouse Pointer Speed:** Slow (slider set to approximately 25%)
- Enable DST:**
- DST Mode:** Auto Manual
- Start Time:** Apr 1st Sun 2 :00
- End Time:** Oct last Sun 2 :00
- DST Bias:** 60 Minutes

An 'Apply' button is located at the bottom left of the settings panel.

Figure 18-1 General Settings Interface

Step 2 Configure the following settings.

Language: The default language used is *English*.

Output Standard: Select the output standard to NTSC or PAL, which must be the same with the video input standard.

Resolution: Configure the resolution of the video output.

Device Name: Edit the name of the device

Device No.: Edit the serial number of the device. The Device No. can be set in the range of 1~255, and the default No. is 255. The number is used for the remote and keyboard control.

Auto Logout: Set timeout time for menu inactivity. E.g., when the timeout time is set to 5 *Minutes*, then the system will exit from the current operation menu to live view screen after 5 minutes of menu inactivity.

Mouse Pointer Speed: Set the speed of mouse pointer; 4 levels are configurable.

Enable Wizard: Enable/disable the Wizard when the device starts up.

Enable Password: Enable/disable the use of the login password.

Step 3 Click **Apply** to save the settings.

18.2 Configure Date & Time

Step 1 Go to **System > General**.

Step 2 Configure the date and time.

Time Zone: Select the time zone.

Date Format: Select the date format.

System Date: Select the system date.

System Time: Set the system time.



| | |
|-------------|----------------------------|
| Time Zone | (GMT+08:00) Beijing, Urumc |
| Date Format | DD-MM-YYYY |
| System Date | 22-08-2017 |
| System Time | 11:34:09 |

Figure 18-2 Date and Time Settings

Step 3 Click **Apply** to save the settings.

18.3 Configure DST Settings

Purpose:

The DST (daylight saving time) refers to the period of the year when clocks are moved one period ahead. In some areas worldwide, this has the effect of creating more sunlit hours in the evening during months when the weather is the warmest.

We advance our clocks ahead a certain period (depends on the DST bias you set) at the beginning of DST, and move them back the same period when we return to standard time (ST).

Step 1 Go to **System > General**.

Step 2 Check **Enable DST**.

The screenshot shows the DST Settings interface with the following configuration:

- Enable DST:** Checked (indicated by a grey square).
- DST Mode:** Radio buttons for 'Auto' and 'Manual', with 'Manual' selected (indicated by a blue dot).
- Start Time:** Apr 1st Su 2:00
- End Time:** Oct 1st Su 2:00
- DST Bias:** 60 Minutes

Figure 18-3 DST Settings Interface

Step 3 Select the DST mode to **Auto** or **Manual**.

- **Auto:** Automatically enable the default DST period according to the local DST rules.
- **Manual:** Manually set the start time and end time of the DST period, and the DST bias.
- **DST Bias:** Set the time (30/60/90/120 minutes) offset from the standard time.
- **Example:** The DST begins at 2:00 a.m. on the second Sunday of March and ends at 2:00 a.m. on the first Sunday of November, with 60 minutes ahead.

Step 4 Click the **Apply** button to save the settings.

18.4 Configure Enhanced IP Mode

Check **Enhanced IP Mode**.

Enabling Enhanced IP Mode will allow you to connect to the maximum number of cameras and make Smart Event unavailable in analog channel.



This function is only available for iDS-7200HQHI-K/S and iDS-7200HUHI-K/S series.

18.5 Manage User Accounts

Purpose:

The *Administrator* user name is *admin* and the password is set when you start the device for the first time. The *Administrator* has the permission to add and delete user and configure user parameters.

18.5.1 Add a User

Step 1 Go to **System > User**.

| No | User Name | Security | Priority | User's MAC Address | Permission |
|----|-----------|-----------------|----------|--------------------|------------|
| 1 | admin | Strong Password | Admin | 00:00:00:00:00:00 | ✓ |

Figure 18-4 User Management Interface

Step 2 Click **Add** to enter the operation permission interface.

Step 3 Enter the admin password and click **Next**.

Add User

User Name: A01

Password: *****

Confirm: *****

Note: Valid password range [8-16]. You can use ...

User Level: Operator

User's MAC Ad...: 00 : 00 : 00 : 00 : 00 : 00

OK

Figure 18-5 Add User

Step 4 In the Add User interface, enter the information for new user, including **User Name**, **Password**, **Confirm** (password), **User Level** (Operator/Guest) and **User's MAC Address**.



WARNING

Strong Password recommended—We highly recommend you create a strong password of your own choosing (Using a minimum of 8 characters, including at least three of the following categories: upper case letters, lower case letters, numbers, and special characters.) in order to increase the security of your product. And we recommend you reset your password regularly, especially in the high security system, resetting the password monthly or weekly can better protect your product.

- **User Level:** Set the user level to Operator or Guest. Different user levels have different operating permission.
 - Operator:** The *Operator* user level has permission of Two-way Audio in Remote Configuration and all operating permission in Camera Configuration by default.
 - Guest:** The Guest user has no permission of Two-way Audio in Remote Configuration and only has the local/remote playback in the Camera Configuration by default.
- **User's MAC Address:** The MAC address of the remote PC which logs onto the device. If it is configured and enabled, it only allows the remote user with this MAC address to access the device.

Step 5 Click **OK** to finish the new user account adding.

Result: In the User Management interface, the added new user is displayed on the list.

| No | User Name | Security | Priority | User's MAC Address | Permission |
|----|-----------|-----------------|----------|--------------------|------------|
| 1 | admin | Strong Password | Admin | 00:00:00:00:00:00 | ✓ |
| 2 | A01 | Strong Password | Operator | 00:00:00:00:00:00 | ✓ |
| 3 | A02 | Strong Password | Operator | 00:00:00:00:00:00 | ✓ |

Figure 18-6 User List

18.5.2 Set Permission for a User

Purpose:

For the added user, you can assign the different permissions, including the local and remote operation for the device.

Step 1 Go to **System > User**.

Step 2 Select a user from the list and then click the  button to enter the permission settings interface.

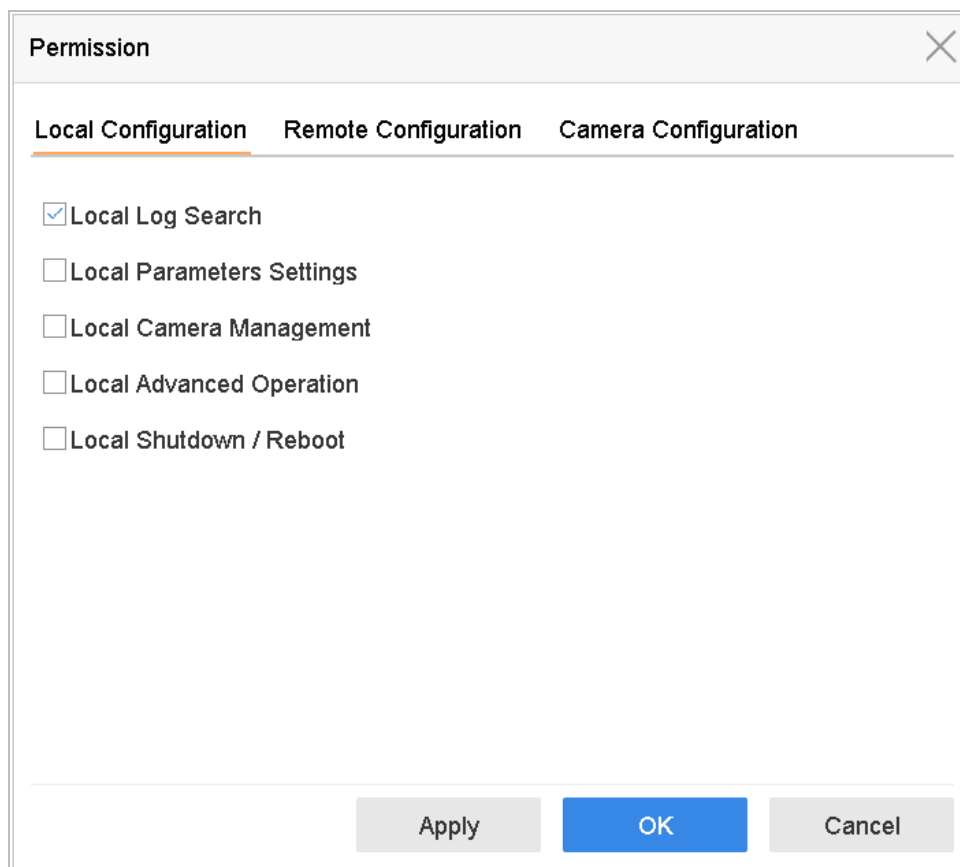

Figure 18-7 User Permission Settings Interface

Step 3 Set the operating permission of Local Configuration, Remote Configuration and Camera Configuration for the user.

● **Local Configuration**

Local Log Search: Searching and viewing logs and system information of device.

Local Parameters Settings: Configuring parameters, restoring factory default parameters and importing/exporting configuration files.

Local Camera Management: The adding, deleting and editing of IP cameras.

Local Advanced Operation: Operating HDD management (initializing HDD, setting HDD property), upgrading system firmware, clearing I/O alarm output.

Local Shutdown Reboot: Shutting down or rebooting the device.

● **Remote Configuration**

Remote Log Search: Remotely viewing logs that are saved on the device.

Remote Parameters Settings: Remotely configuring parameters, restoring factory default parameters and importing/exporting configuration files.

Remote Camera Management: Remote adding, deleting and editing of the IP cameras.

Remote Serial Port Control: Configuring settings for RS-232 and RS-485 ports.

Remote Video Output Control: Sending remote button control signal.

Two-Way Audio: Realizing two-way radio between the remote client and the device.

Remote Alarm Control: Remotely arming (notify alarm and exception message to the remote client) and controlling the alarm output.

Remote Advanced Operation: Remotely operating HDD management (initializing HDD, setting HDD property), upgrading system firmware, clearing I/O alarm output.

Remote Shutdown/Reboot: Remotely shutting down or rebooting the device.

- Camera Configuration

Remote Live View: Remotely viewing live video of the selected camera (s).

Local Manual Operation: Locally starting/stopping manual recording and alarm output of the selected camera (s).

Remote Manual Operation: Remotely starting/stopping manual recording and alarm output of the selected camera (s).

Local Playback: Locally playing back recorded files of the selected camera (s).

Remote Playback: Remotely playing back recorded files of the selected camera (s).

Local PTZ Control: Locally controlling PTZ movement of the selected camera (s).

Remote PTZ Control: Remotely controlling PTZ movement of the selected camera (s).

Local Video Export: Locally exporting recorded files of the selected camera (s).

Step 4 Click **OK** to save the settings.



NOTE

Only the admin user account has the permission of restoring factory default parameters.

18.5.3 Set Local Live View Permission for Non-Admin Users

Step 1 Go to **System > User**.

Step 2 Click  of admin user.

Step 3 Enter admin password and click **OK**.

Step 4 Select cameras that non-admin user can view in local and click **OK**.

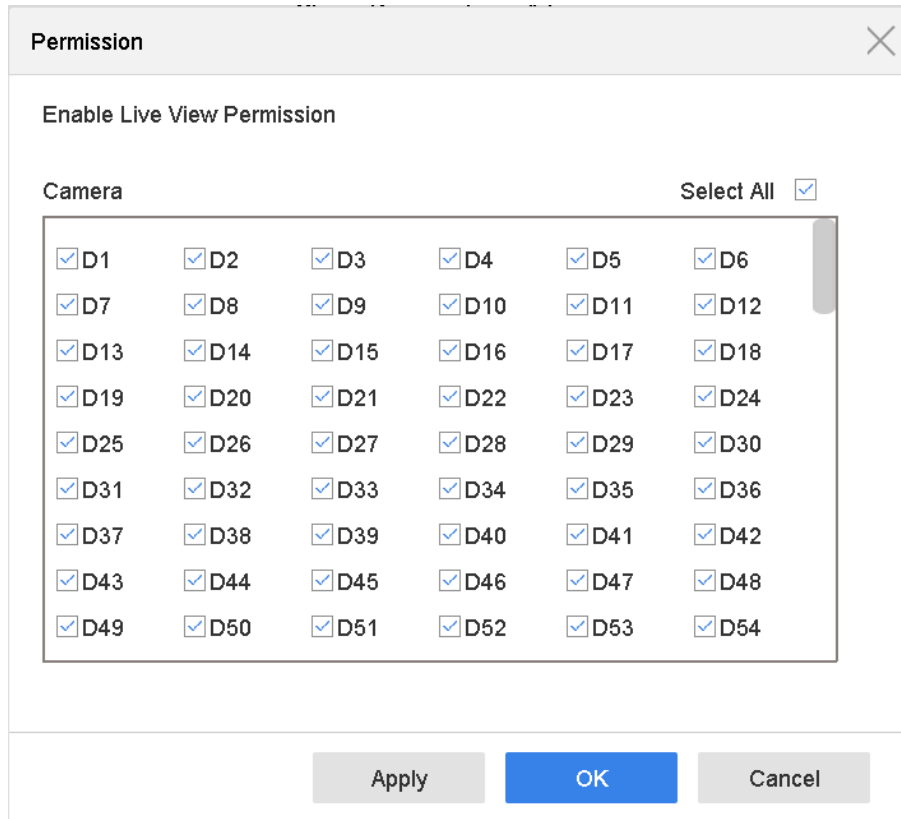



Figure 18-8 Enable Live View Permission

Step 5 Click  of non-admin user.

Step 6 Enter **Camera Configuration** interface.

Step 7 Select **Camera Permission** as **Local Live View**.

Step 8 Select cameras to live view.

Step 9 Click **OK**.

18.5.4 Edit the Admin User

Purpose:

For the admin user account, you can modify your password and unlock pattern.

Step 1 Go to **System > User**.

Step 2 Select the admin user from the list.

Step 3 Click **Modify**.

Figure 18-9 Edit Admin User

Step 4 Edit the admin user information as demand, including the new admin password (strong password is required), and MAC address.

Step 5 Edit the unlock pattern for the admin user account.

- 1) Check **Enable Unlock Pattern** to enable the use of unlock pattern when logging in to the device.
- 2) Use the mouse to draw a pattern among the 9 dots on the screen, and release the mouse when the pattern is done.

Step 6 Check **Export** of **Export GUID** to export the GUID file for the admin user account.

 **NOTE**

When the admin password is changed, export the new GUID to the connected USB flash drive for the future password resetting.

Step 7 Configure security question for password resetting.

Step 8 Configure reserved email for password resetting.

Step 9 Click **OK** to save the settings.

18.5.5 Edit the Operator/Guest User

Purpose:

You can edit the user information, including user name, password, permission level and MAC address. Check the checkbox of **Change Password** if you want to change the password, and input the new password in the text field of **Password** and **Confirm**. A strong password is recommended.

Step 1 Go to **System > User**.

Step 2 Select a user from the list and click **Modify**.

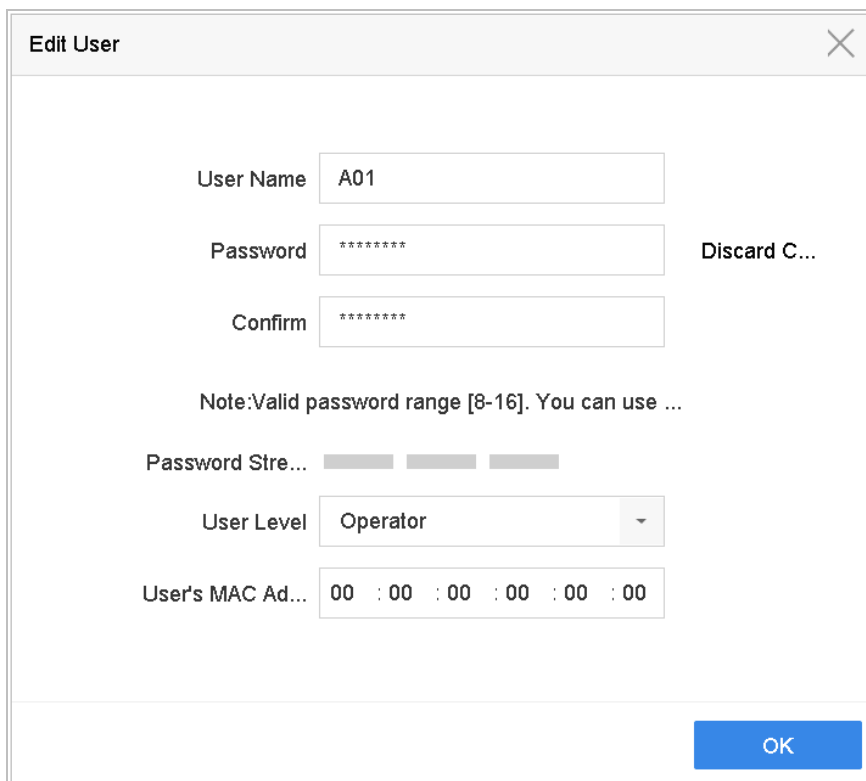

Figure 18-10 Edit User (Operator/Guest)

Step 3 Edit the user information as demand, including the new password (strong password is required), and MAC address.

18.5.6 Delete a User

Purpose:

The admin user account has the permission to delete the operator/guest user account.

Step 1 Go to **System > User**.

Step 2 Select a user from the list.

Step 3 Click **Delete** to delete the selected user account.

18.6 Configure Password Security

18.6.1 Export GUID File

Purpose:

The GUID file will help you to reset password when you forget your password.

Step 1 Check **Export GUID** when you are activating the device, or check **Export** when you are editing the admin user account.

Step 2 Insert a USB flash drive to your device, and export the GUID file to the USB flash drive.

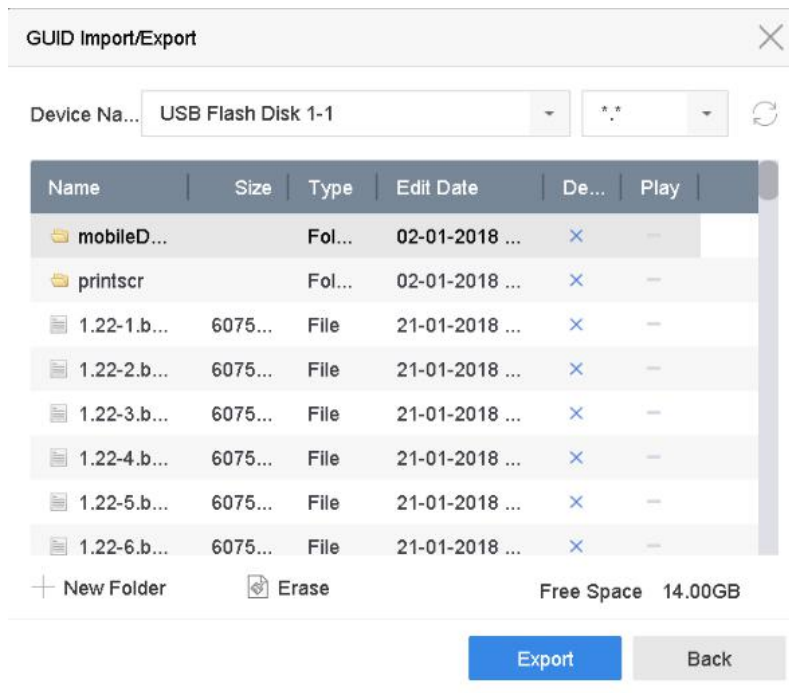

Figure 18-11 Export GUID File

NOTE

Please keep your GUID file properly for future password resetting.

18.6.2 Configure Security Questions

Purpose:

The security question configuration will help you to reset password when you forget your password or encounter security issues.

Step 1 Check **Security Question Configuration** when you are activating the device, or click  when you are editing the admin user account.

Step 2 Set three security questions and answers.

Step 3 Click **OK**.

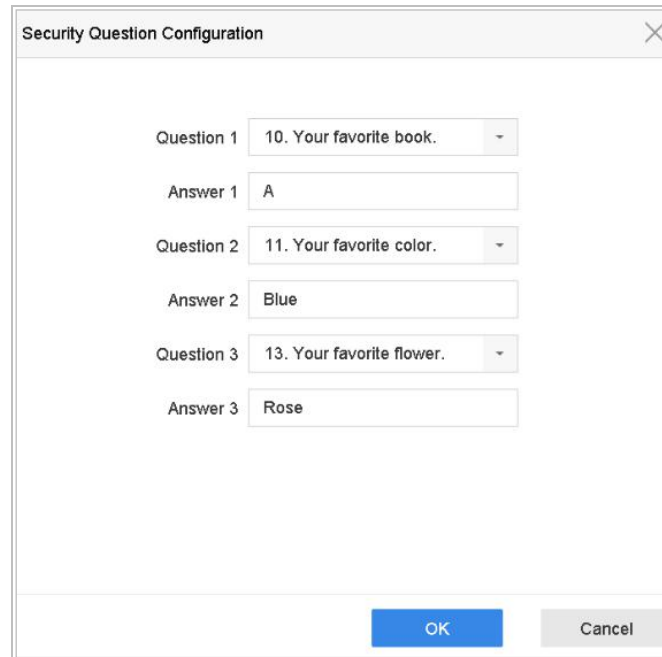

The screenshot shows a dialog box titled "Security Question Configuration". It contains three rows of configuration for security questions. Each row consists of a question label, a dropdown menu for the question, and a text input field for the answer. The first row is "Question 1" with the question "10. Your favorite book." and the answer "A". The second row is "Question 2" with the question "11. Your favorite color." and the answer "Blue". The third row is "Question 3" with the question "13. Your favorite flower." and the answer "Rose". At the bottom right of the dialog, there are two buttons: "OK" (highlighted in blue) and "Cancel".

Figure 18-12 Configure Security Questions

18.6.3 Configure Reserved Email

Purpose:

The reserved email will help you to reset password when you forget your password.

Step 1 Check **Reserved E-mail** when you are activating the device, or click **Modify** when you are editing the admin user account.

Step 2 Enter reserved email address.

Step 3 Click **OK**.

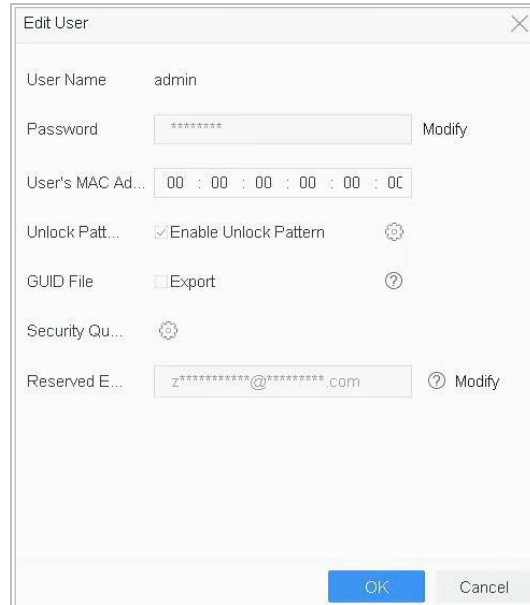

Figure 18-13 Configure Reserved Email

18.7 Reset Password

When you forget the admin password, there are three ways to reset the password, including importing the GUID file, answering security questions, and using your reserved email.

18.7.1 Reset Password by GUID

Before You Start

The GUID file must be exported and saved in the USB flash drive after you have activated the device or edited the admin user account. (Refer to 18.6.1 Export GUID File).

Step 1 On the user login interface, click **Forgot Password**.

Step 2 Select the password resetting type to **Verify by GUID**.

Step 3 Insert the USB flash drive that contains GUID file to the device.

Step 4 Click **OK**.



Figure 18-14 Import GUID File

Step 5 Select the GUID file from the USB flash drive and click **Import** to import the file to the device.

Step 6 After the GUID file is successfully imported, enter the reset password interface to set the new admin password.

Step 7 Click **OK** to set the new password. You can export the new GUID file to the USB flash drive for future password resetting.

 **NOTE**

When the new password is set, the original GUID file will be invalid.

18.7.2 Reset Password by Security Questions

Before You Start

Ensure you have configured the security questions when you are activating the device or editing the admin user account. (Refer to 18.7.2 Reset Password by Security Questions).

Step 1 On the user login interface, click **Forgot Password**.

Step 2 Select the password resetting type to **Verify by Security Question**.

Step 3 Input the correct answers of the three security questions.

Step 4 Click **OK** to set the new password.

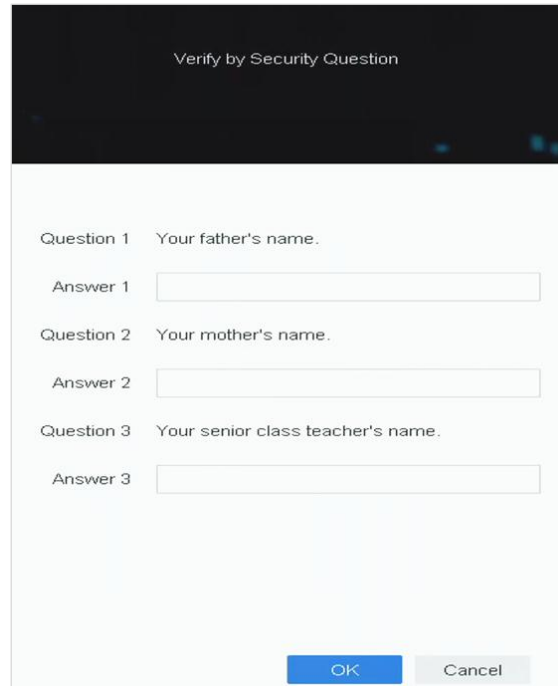

Verify by Security Question

Question 1 Your father's name.

Answer 1

Question 2 Your mother's name.

Answer 2

Question 3 Your senior class teacher's name.

Answer 3

OK Cancel

Figure 18-15 Verify by Security Question

18.7.3 Reset Password by Reserved Email

Before You Start

Ensure you have configured the reserved email when you are activating the device or editing the admin user account. (Refer to 18.6.3 Configure Reserved Email)

Step 1 On the user login interface, click **Forgot Password**.

Step 2 Select the password resetting type to **Verify by Reserved Email**.

Step 3 Click **OK**.

Step 4 Click **Next** if you accept the legal disclaimer. You can use a smartphone to scan the QR code to read the legal disclaimer.

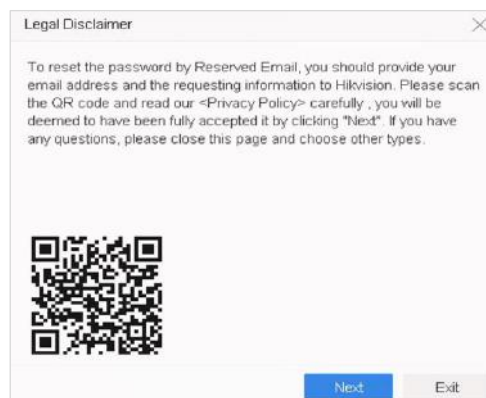

Figure 18-16 Legal Disclaimer

Step 5 Obtain the verification code. There are two ways to get the verification code.

- Use Hik-Connect app to scan the QR code. You can find the scanning tool in **More > Reset Device Password**.
- Send the QR code to email server.
 - 1) Insert a USB flash drive to your device.
 - 2) Click **Export** to export the QR code to USB flash drive.
 - 3) Email the QR code to *pw_recovery@hikvision.com* as attachment.



Figure 18-17 Verify by Reserved Email

Step 6 Check your reserved email, and you will receive a verification code within 5 minutes.

Step 7 Enter the verification code.

Step 8 Click **OK** to set the new password.

Chapter 19 Appendix

List of Applicable Power Adapter



NOTE

Use only power supplies listed in the user instructions.

| Power Adapter Model | Specifications | Manufacturer |
|------------------------|--|---|
| MSA-C1500IC12.0-18P-DE | 12 V, 1.5 A | 0000201935 MOSO Technology Co., Ltd. |
| ADS-25FSG-12 12018GPG | CE, 100 to 240 VAC, 12 V, 1.5 A, 18 W, $\Phi 5.5 \times 2.1 \times 10$ | 0000200174 Shenzhen Honor Electronic Co., Ltd. |
| MSA-C1500IC12.0-18P-US | 12 V, 1.5 A | 0000201935 MOSO Technology Co., Ltd. |
| TS-A018-120015AD | 100 to 240 VAC, 12 V, 1.5 A, 18 W, $\Phi 5.5 \times 2.1 \times 10$ | 0000200878 Shenzhen Transin Technologies Co., Ltd. |
| MSA-C2000IC12.0-24P-DE | 12 V, 2 A | 0000201935 MOSO Technology Co., Ltd. |
| ADS-24S-12 1224GPG | CE, 100 to 240 VAC, 12 V, 2 A, 24 W, $\Phi 2.1$ | 0000200174 Shenzhen Honor Electronic Co., Ltd. |
| MSA-C2000IC12.0-24P-US | US, 12 V, 2 A | 0000201935 MOSO Technology Co., Ltd. |
| ADS-26FSG-12 12024EPCU | US, 12 V, 2 A | 0000200174 Shenzhen Honor Electronic Co., Ltd. |
| KPL-040F-VI | 12 V, 3.33 A, 40 W | 0000203078 Channel Well Technology Co., Ltd. |
| MSA-Z3330IC12.0-48W-Q | 12 V, 3.33 A | 0000201935 MOSO Technology Co., Ltd. |
| MSP-Z1360IC48.0-65W | 48 V, 1.36 A | 0000201935 MOSO Technology Co., Ltd. |
| KPL-050S-II | 48 V, 1.04 A | 0000203078 |

| | | |
|--|--|--------------------------------------|
| | | Channel Well Technology Co., Ltd. |
|--|--|--------------------------------------|

04201001090329



See Far, Go Further