



Digital Video Recorder

User Manual

User Manual

COPYRIGHT ©2018 Hangzhou Hikvision Digital Technology Co., Ltd.

ALL RIGHTS RESERVED.

Any and all information, including, among others, wordings, pictures, graphs are the properties of Hangzhou Hikvision Digital Technology Co., Ltd. or its subsidiaries (hereinafter referred to be “Hikvision”). This user manual (hereinafter referred to be “the Manual”) cannot be reproduced, changed, translated, or distributed, partially or wholly, by any means, without the prior written permission of Hikvision. Unless otherwise stipulated, Hikvision does not make any warranties, guarantees or representations, express or implied, regarding to the Manual.

About this Manual

This Manual is applicable to Turbo HD Digital Video Recorder (DVR).

The Manual includes instructions for using and managing the product. Pictures, charts, images and all other information hereinafter are for description and explanation only. The information contained in the Manual is subject to change, without notice, due to firmware updates or other reasons. Please find the latest version in the company website (<http://overseas.hikvision.com/en/>).

Please use this user manual under the guidance of professionals.

Trademarks Acknowledgement

HIKVISION and other Hikvision’s trademarks and logos are the properties of Hikvision in various jurisdictions. Other trademarks and logos mentioned below are the properties of their respective owners.

Legal Disclaimer

TO THE MAXIMUM EXTENT PERMITTED BY APPLICABLE LAW, THE PRODUCT DESCRIBED, WITH ITS HARDWARE, SOFTWARE AND FIRMWARE, IS PROVIDED “AS IS”, WITH ALL FAULTS AND ERRORS, AND HIKVISION MAKES NO WARRANTIES, EXPRESS OR IMPLIED, INCLUDING WITHOUT LIMITATION, MERCHANTABILITY, SATISFACTORY QUALITY, FITNESS FOR A PARTICULAR PURPOSE, AND NON-INFRINGEMENT OF THIRD PARTY. IN NO EVENT WILL HIKVISION, ITS DIRECTORS, OFFICERS, EMPLOYEES, OR AGENTS BE LIABLE TO YOU FOR ANY SPECIAL, CONSEQUENTIAL, INCIDENTAL, OR INDIRECT DAMAGES, INCLUDING, AMONG OTHERS, DAMAGES FOR LOSS OF BUSINESS PROFITS, BUSINESS INTERRUPTION, OR LOSS OF DATA OR DOCUMENTATION, IN CONNECTION WITH THE USE OF THIS PRODUCT, EVEN IF HIKVISION HAS BEEN ADVISED OF THE POSSIBILITY OF SUCH DAMAGES.

REGARDING TO THE PRODUCT WITH INTERNET ACCESS, THE USE OF PRODUCT SHALL BE WHOLLY AT YOUR OWN RISKS. HIKVISION SHALL NOT TAKE ANY RESPONSIBILITIES FOR ABNORMAL OPERATION, PRIVACY LEAKAGE OR OTHER DAMAGES RESULTING FROM CYBER ATTACK, HACKER ATTACK, VIRUS INSPECTION, OR OTHER INTERNET SECURITY RISKS; HOWEVER, HIKVISION WILL PROVIDE TIMELY TECHNICAL SUPPORT IF REQUIRED.

SURVEILLANCE LAWS VARY BY JURISDICTION. PLEASE CHECK ALL RELEVANT LAWS IN YOUR JURISDICTION BEFORE USING THIS PRODUCT IN ORDER TO ENSURE THAT YOUR USE CONFORMS THE APPLICABLE LAW. HIKVISION SHALL NOT BE LIABLE IN THE EVENT THAT THIS PRODUCT IS USED WITH ILLEGITIMATE PURPOSES.

IN THE EVENT OF ANY CONFLICTS BETWEEN THIS MANUAL AND THE APPLICABLE LAW, THE LATER PREVAILS.

Regulatory Information

FCC Information

Please take attention that changes or modification not expressly approved by the party responsible for compliance could void the user's authority to operate the equipment.

FCC compliance: This equipment has been tested and found to comply with the limits for a Class A digital device, pursuant to part 15 of the FCC Rules. These limits are designed to provide reasonable protection against harmful interference when the equipment is operated in a commercial environment. This equipment generates, uses, and can radiate radio frequency energy and, if not installed and used in accordance with the instruction manual, may cause harmful interference to radio communications. Operation of this equipment in a residential area is likely to cause harmful interference in which case the user will be required to correct the interference at his own expense.

FCC Conditions

This device complies with part 15 of the FCC Rules. Operation is subject to the following two conditions:

1. This device may not cause harmful interference.
2. This device must accept any interference received, including interference that may cause undesired operation.

EU Conformity Statement



This product and - if applicable - the supplied accessories too are marked with "CE" and comply therefore with the applicable harmonized European standards listed under the EMC Directive 2014/30/EU, the LVD Directive 2014/35/EU, the RoHS Directive 2011/65/EU.



2012/19/EU (WEEE directive): Products marked with this symbol cannot be disposed of as unsorted municipal waste in the European Union. For proper recycling, return this product to your local supplier upon the purchase of equivalent new equipment, or dispose of it at designated collection points. For more information see: www.recyclethis.info



2006/66/EC (battery directive): This product contains a battery that cannot be disposed of as unsorted municipal waste in the European Union. See the product documentation for specific battery information. The battery is marked with this symbol, which may include lettering to indicate cadmium (Cd), lead (Pb), or mercury (Hg). For proper recycling, return the battery to your supplier or to a designated collection point. For more information see: www.recyclethis.info

Industry Canada ICES-003 Compliance

This device meets the CAN ICES-3 (A)/NMB-3(A) standards requirements.

Applicable Models



This manual is applicable to the models listed in the following table.

Series	Model
DS-7100HQHI-K1	DS-7104HQHI-K1 DS-7108HQHI-K1 DS-7116HQHI-K1
DS-7100HUHI-K1	DS-7104HUHI-K1 DS-7108HUHI-K1
DS-7200HQHI-K1	DS-7204HQHI-K1 DS-7208HQHI-K1 DS-7216HQHI-K1
DS-7200HQHI-K2	DS-7208HQHI-K2 DS-7216HQHI-K2
DS-7200HQHI-K/P	DS-7204HQHI-K1/P DS-7208HQHI-K2/P DS-7216HQHI-K2/P
DS-7200HUHI-K1	DS-7204HUHI-K1 DS-7208HUHI-K1
DS-7200HUHI-K2	DS-7204HUHI-K2 DS-7208HUHI-K2 DS-7216HUHI-K2
DS-7200HUHI-K/P	DS-7204HUHI-K1/P DS-7208HUHI-K2/P DS-7216HUHI-K2/P
DS-7300HQHI-K4	DS-7304HQHI-K4 DS-7308HQHI-K4 DS-7316HQHI-K4

DS-7300HUHI-K4	DS-7304HUHI-K4 DS-7308HUHI-K4 DS-7316HUHI-K4
DS-9000HUHI-K8	DS-9008HUHI-K8 DS-9016HUHI-K8
DS-7200HTHI-K1	DS-7204HTHI-K1
DS-7200HTHI-K2	DS-7204HTHI-K2 DS-7208HTHI-K2

Symbol Conventions

The symbols that may be found in this document are defined as follows.

Symbol	Description
 NOTE	Provides additional information to emphasize or supplement important points of the main text.
 WARNING	Indicates a potentially hazardous situation, which if not avoided, could result in equipment damage, data loss, performance degradation, or unexpected results.
 DANGER	Indicates a hazard with a high level of risk, which if not avoided, will result in death or serious injury.

Safety Instructions

- Proper configuration of all passwords and other security settings is the responsibility of the installer and/or end-user.
- In the use of the product, you must be in strict compliance with the electrical safety regulations of the nation and region. Please refer to technical specifications for detailed information.
- Input voltage should meet both the SELV (Safety Extra Low Voltage) and the Limited Power Source with 100 to 240 VAC, 12 VDC or 48 VDC according to the IEC60950-1 standard. Please refer to technical specifications for detailed information.
- Do not connect several devices to one power adapter as adapter overload may cause over-heating or a fire hazard.
- Please make sure that the plug is firmly connected to the power socket.

- If smoke, odor or noise rise from the device, turn off the power at once and unplug the power cable, and then please contact the service center.

Preventive and Cautionary Tips

Before connecting and operating your device, please be advised of the following tips:

- Ensure unit is installed in a well-ventilated, dust-free environment.
- Unit is designed for indoor use only.
- Keep all liquids away from the device.
- Ensure environmental conditions meet factory specifications.
- Ensure unit is properly secured to a rack or shelf. Major shocks or jolts to the unit as a result of dropping it may cause damage to the sensitive electronics within the unit.
- Use the device in conjunction with an UPS if possible.
- Power down the unit before connecting and disconnecting accessories and peripherals.
- A factory recommended HDD should be used for this device.
- Improper use or replacement of the battery may result in hazard of explosion. Replace with the same or equivalent type only. Dispose of used batteries according to the instructions provided by the battery manufacturer.
- Ensure to use the attached power adaptor only and not to change the adaptor randomly.
- The USB flash drive can only connect to mouse or keyboard.
- Use only power supplies listed in the user instructions.

Product Key Features

General

- Connectable to Turbo HD and analog cameras;
- Supports UTC (Coaxitron) protocol for connecting camera over coax;
- Connectable to AHD cameras;
- Connectable to HDCVI cameras;
- Connectable to IP cameras;
- The analog signal inputs including Turbo HD, AHD, HDCVI, and CVBS can be automatically recognized without configuration;
- -K/P series DVR support PoC (Power over Coaxitron) cameras connection. DVR will detect the connected PoC cameras automatically, manage the power consumption via the coaxial communication, and provide power to the cameras via coaxitron;
- Each channel supports dual-stream. And sub-stream supports up to WD1 resolution;
- HQHI series DVR support up to 4 MP lite resolution of all the channels;
- HTHI, 7108HUHI, 7208/7216HUHI, 7300HUHI, and 9000HUHI series DVR support up to 8 MP resolution of all the channels;
- For HUHI and HTHI series DVR, 5 MP long distance transmission can be enabled for the analog cameras;
- Independent configuration for each channel, including resolution, frame rate, bit rate, image quality, etc.;
- The minimum frame rate for main stream and sub-stream is 1 fps;
- Encoding for both video stream and video & audio stream; audio and video synchronization during composite stream encoding;
- Supports enabling H.265+/H.264+ to ensure high video quality with lowered bit rate;
- H.265+/H.265/H.264+/H.264 encoding for the main stream, and H.265/H.264 encoding for the sub-stream of analog cameras;
- Connectable to H.265 and H.264 IP cameras;
- For 7100HUHI, 7208/7216HUHI, 7300HUHI, and 9000HUHI series DVR, if the video encoding is H.264 or H.265, when 8 MP signal input is connected, H.264+ or H.265+ is disabled. If the video encoding is H.264+ or H.265+, when 8 MP signal input is connected, the video encoding will change to H.264 or H.265 automatically, and H.264+ or H.265+ is disabled;
- Defog level, night to day sensitivity, day to night sensitivity, IR light brightness, day/night mode, and WDR switch configurable for the connected analog cameras supporting these parameters;
- 4 MP/5 MP signal switch for the supported analog cameras;
- Watermark technology.

Local Monitoring

- HDMI output at up to 4K (3840 × 2160) resolution;
- For DS-7300/9000HUHI-K series, there are two HDMI interfaces of which the HDMI1 and VGA interfaces share simultaneous output. For HDMI1/VGA output, up to 1920 × 1080 resolution is supported. For HDMI2 output, up to 4K (3840 × 2160) resolution is supported;
- 1/4/6/8/9/16/25/36 screen live view is supported, and the display sequence of screens is adjustable;



NOTE

- For DS-7300/9000HUHI-K series DVR, if the sum of the analog and IP channels exceeds 25, up to 32-window division mode is supported for the VGA/HDMI1 output.
- For HUHI and HTHI series DVR, if you set the video output resolution as 1024*768, when you set more than 16 windows, the device will recommend you to switch to higher output resolution. If you set the video output resolution as 1280*720 or 1280*1024, when you set more than 25 windows, the same note will pop up.
- Live view screen can be switched in group and manual switch and automatic cycle live view are also provided, the interval of automatic cycle can be adjusted;
- CVBS output only serves as the aux output or live view output.
- Quick setting menu is provided for live view;
- The selected live view channel can be shielded;
- For HUHI and HTHI series DVR, VCA information overlay in live view for the supported analog cameras and in smart playback for the supported analog and IP cameras;
- Motion detection, video-tampering detection, video exception alarm, video loss alarm and VCA alarm functions;
- For DS-7300/9000HUHI-K series DVR, 1-ch analog camera supports people counting and heat map functions
- -K/P series DVR can detect the PoC module exception. When it cannot detect the PoC module or the PoC module is powered off abnormally, alarms are triggered, and linkage methods are configurable;
- VCA detection alarm is supported;
- For HUHI series DVR, the enhanced VCA mode conflicts with the 2K/4K output and 4 MP/5 MP/8 MP signal input;
- Enhanced IP mode will allow you to connect to the maximum number of cameras, but disable all VCA functions. It conflicts with the enhanced VCA mode and 4K output.
- Privacy mask;
- Several PTZ protocols (including Omnicast VMS of Genetec) supported; PTZ preset, patrol and pattern;
- Zooming in/out by clicking the mouse and PTZ tracing by dragging mouse;
- When Hikvision CVBS camera is connected, you can control PTZ via Coaxitron and call the OSD of the camera.

HDD Management

- Each disk with a maximum of 10 TB storage capacity for HTHI, HUHI and 7200/7300HQHI series DVR, and 6 TB for DS-7100HQHI-K1;
- 8 network disks (8 NAS disks, 8 IP SAN disks or n NAS disks + m IP SAN disks ($n+m \leq 8$)) can be connected;
- Remaining recording time of the HDD can be viewed;
- Supports cloud storage;
- S.M.A.R.T. and bad sector detection;
- HDD sleeping function;
- HDD property: redundancy, read-only, read/write (R/W);
- HDD group management;
- HDD quota management; different capacity can be assigned to different channels.
- For DS-7300/9000HUHI-K series, hot-swappable HDD supporting RAID0, RAID1, RAID5, RAID 6 and RAID10 storage scheme, and can be enabled and disabled on your demand. And 16 arrays can be configured.

Recording, Capture and Playback



NOTE

Capture is supported by DS-7300/9000HUHI-K series DVR only.

- Holiday recording schedule configuration;
- Cycle and non-cycle recording modes;
- Normal and event video encoding parameters;
- Multiple recording types: manual, continuous, alarm, motion, motion | alarm, motion & alarm and event;
- The device will note that the exported AVI video may have problems if the frame rates of the continuous and event recording are different;
- Supports POS triggered recording for DS-7300HQHI and DS-7300/9000HUHI-K series DVR;
- 8 recording time periods with separated recording types;
- Supports Channel-Zero encoding;
- Main stream and sub-stream configurable for simultaneous recording;
- Pre-record and post-record for motion detection triggered recording, and pre-record time for schedule and manual recording;
- Searching record files and captured pictures by events (alarm input/motion detection);
- Customization of tags, searching and playing back by tags;
- Locking and unlocking of record files;
- Local redundant recording and capture;

- When Turbo HD, AHD, or HDCVI input is connected, the information including the resolution and frame rate will be overlaid on the bottom right corner of the live view for 5 seconds. When CVBS input is connected, the information such as NTSC or PAL will be overlaid on the bottom right corner of the live view for 5 seconds.
- Searching and playing back record files by camera number, recording type, start time, end time, etc.;
- Smart playback to go through less effective information;
- Main stream and sub-stream selectable for local/remote playback;
- Zooming in for any area when playback;
- Multi-channel reverse playback;
- Supports pause, fast forward, slow forward, skip forward, and skip backward when playback, locating by dragging the mouse on the progress bar;
- 4/8/16-ch synchronous playback;
- Manual capture, continuous capture of video images and playback of captured pictures.

Backup

- Exports data by a USB, and SATA device;
- Exports video clips when playback;
- Video and Log, Video and Player, and Player are selectable to export for backup;
- Management and maintenance of backup devices.

Alarm and Exception

- Configurable arming time of alarm input/output;
- Alarms for video loss, motion detection, video tampering, illegal login, network disconnected, IP confliction, record/capture exception, HDD error, and HDD full, etc.;
- Alarm triggers full screen monitoring, audio alarm, notifying surveillance center, sending email and alarm output;
- One-key disarms the linkage actions of the alarm input;
- PTZ linking for the VCA alarm;
- VCA detection alarm is supported;



NOTE

DS-7100 does not support VCA alarm.

- Supports POS triggered alarm;
- Supports coaxial alarm;
- System will automatically reboot when a problem is detected in an attempt to restore normal functionality;

- You can enable false alarm filter for the motion detection of the PIR cameras. Then only when the motion detection events and PIR events are both triggered, the motion detection alarm will be triggered.

Other Local Functions

- Manual and automatic video quality diagnostics;
- Operable by mouse and remote control;
- Three-level user management; admin user can create many operating account and define their operating permission, which includes the permission to access any channel;
- Completeness of operation, alarm, exceptions and log writing and searching;
- Manually triggering and clearing alarms;
- Importing and exporting of configuration file of devices;
- Getting cameras type information automatically;
- Unlock pattern for device login for the *admin*;
- Clear-text password available;
- GUID file can be exported for password resetting;
- Multiple connected analog cameras supporting Turbo HD or AHD signal can be upgraded simultaneously via DVR.

Network Functions

- Self-adaptive 100M or 1000M network interface;
- IPv6 is supported;
- TCP/IP protocol, PPPoE, DHCP, DNS, DDNS, NTP, SADP, SNMP (for 7300HQHI/HUHI and 9000HUHI series DVR), SMTP, NFS, iSCSI, UPnP™ and HTTPS are supported;
- Supports access by Hik-Connect. If you enable Hik-Connect, the device will remind you the internet access risk and ask you to confirm the “Terms of Service” and “Privacy Statement” before enabling the service. You should create a verification code to connect to the Hik-Connect;
- TCP, UDP and RTP for unicast;
- Auto/Manual port mapping by UPnP™;
- Remote search, playback, download, locking and unlocking the record files, and downloading files broken transfer resume;
- Remote parameters setup; remote import/export of device parameters;
- Remote viewing of the device status, system logs and alarm status;
- Remote keyboard operation;
- Remote HDD formatting and program upgrading;
- Remote system restart and shutdown;
- Supports upgrading via remote FTP server;

- RS-485 transparent channel transmission;
- Alarm and exception information can be sent to the remote host;
- Remotely start/stop recording;
- Remotely start/stop alarm output;
- Remote PTZ control;
- Two-way audio and voice broadcasting;
- Output bandwidth limit configurable;
- Embedded WEB server;
- If DHCP is enabled, you can enable DNS DHCP or disable it and edit the Preferred DNS Server and Alternate DNS Server.

Development Scalability

- SDK for Windows and Linux system;
- Source code of application software for demo;
- Development support and training for application system.

Table of Contents

Product Key Features	6
Chapter 1 Introduction.....	17
1.1 Front Panel	17
1.2 IR Remote Control Operations	26
1.3 USB Mouse Operation.....	29
1.4 Input Method Description.....	31
1.5 Rear Panel	31
Chapter 2 Getting Started	38
2.1 Starting Up and Shutting Down the DVR.....	38
2.2 Activating the Device.....	39
2.3 Using the Unlock Pattern for Login	41
2.3.1 Configuring the Unlock Pattern.....	42
2.3.2 Logging in via Unlock Pattern.....	43
2.4 Basic Configuration in Startup Wizard	45
2.5 Login and Logout.....	50
2.5.1 User Login.....	50
2.5.2 User Logout	51
2.6 Resetting Your Password	51
2.7 Adding and Connecting the IP Cameras.....	53
2.7.1 Activating the IP Camera	53
2.7.2 Adding the Online IP Camera	55
2.7.3 Editing the Connected IP Camera	59
2.8 Connecting PoC Cameras	60
2.9 Configuring Signal Input Channel.....	61
2.10 Configuring 5 MP Long Distance Transmission	62
Chapter 3 Live View	64
3.1 Introduction of Live View	64
3.2 Operations in Live View Mode.....	64
3.2.1 Using the Mouse in Live View	66
3.2.2 Switching Main/Aux Output.....	67
3.2.3 Quick Setting Toolbar in Live View Mode	68
3.3 Channel-Zero Encoding	71
3.4 Adjusting Live View Settings	71

3.5 Manual Video Quality Diagnostics	73
Chapter 4 PTZ Controls	75
4.1 Configuring PTZ Settings	75
4.2 Setting PTZ Presets, Patrols and Patterns	77
4.2.1 Customizing Presets	77
4.2.2 Calling Presets	78
4.2.3 Customizing Patrols	78
4.2.4 Calling Patrols	79
4.2.5 Customizing Patterns	80
4.2.6 Calling Patterns	81
4.2.7 Customizing Linear Scan Limit	81
4.2.8 Calling Linear Scan	82
4.2.9 One-Touch Park	83
4.3 PTZ Control Panel	84
Chapter 5 Recording and Capture Settings	86
5.1 Configuring Encoding Parameters	86
5.2 Configuring Recording and Capture Schedule	92
5.3 Configuring Motion Detection Recording and Capture	96
5.4 Configuring Alarm Triggered Recording and Capture	97
5.5 Configuring Event Recording and Capture	99
5.6 Configuring Manual Recording and Continuous Capture	101
5.7 Configuring Holiday Recording and Capture	101
5.8 Configuring Redundant Recording and Capture	103
5.9 Configuring HDD Group	104
5.10 Files Protection	105
5.11 One-Key Enabling and Disabling H.264+/H.265+ for Analog Cameras	108
5.12 Configuring 1080P Lite	109
Chapter 6 Playback	111
6.1 Playing Back Record Files	111
6.1.1 Instant Playback	111
6.1.2 Playing Back by Normal Search	111
6.1.3 Playing Back by Event Search	114
6.1.4 Playing Back by Tag	116
6.1.5 Playing Back by Smart Search	119

6.1.6	Playing Back by System Logs	123
6.1.7	Playing Back by Sub-Periods.....	125
6.1.8	Playing Back External File.....	126
6.1.9	Playing Back Pictures.....	126
6.2	Auxiliary Functions of Playback.....	128
6.2.1	Playing Back Frame by Frame	128
6.2.2	Digital Zoom	128
6.2.3	Reverse Playback of Multi-Channel.....	129
6.2.4	File Management	129
Chapter 7	Backup.....	131
7.1	Backing up Record Files.....	131
7.1.1	Backing up by Normal Video/Picture Search	131
7.1.2	Backing up by Event Search.....	133
7.1.3	Backing up Video Clips	134
7.2	Managing Backup Devices.....	135
Chapter 8	Alarm Settings.....	137
8.1	Setting Motion Detection.....	137
8.2	Setting PIR Camera Alarm	140
8.3	Setting Sensor Alarms	141
8.4	Detecting Video Loss.....	144
8.5	Detecting Video Tampering	145
8.6	Setting All-day Video Quality Diagnostics.....	147
8.7	Handling Exceptions	148
8.8	Setting Alarm Response Actions	150
Chapter 9	POS Configuration.....	153
9.1	Configuring POS Settings.....	153
9.2	Configuring Overlay Channel.....	158
9.3	Configuring POS Alarm	159
Chapter 10	VCA Alarm	161
10.1	Face Detection.....	161
10.2	Vehicle Detection	163
10.3	Line Crossing Detection.....	164
10.4	Intrusion Detection	166
10.5	Region Entrance Detection	167

10.6 Region Exiting Detection	168
10.7 Loitering Detection.....	169
10.8 People Gathering Detection	169
10.9 Fast Moving Detection	169
10.10 Parking Detection	170
10.11 Unattended Baggage Detection	170
10.12 Object Removal Detection	171
10.13 Audio Exception Detection.....	171
10.14 Defocus Detection.....	172
10.15 Sudden Scene Change	173
10.16 PIR Alarm.....	173
Chapter 11 VCA Search.....	175
11.1 Face Search.....	175
11.2 Behavior Search.....	177
11.3 Plate Search.....	178
11.4 People Counting	179
11.5 Heat Map.....	180
Chapter 12 Network Settings	182
12.1 Configuring General Settings	182
12.2 Configuring Advanced Settings	183
12.2.1 Configuring PPPoE Settings	183
12.2.2 Configuring Hik-Connect	183
12.2.3 Configuring DDNS.....	186
12.2.4 Configuring NTP Server	188
12.2.5 Configuring NAT	188
12.2.6 Configuring More Settings	190
12.2.7 Configuring HTTPS Port	191
12.2.8 Configuring Email	193
12.2.9 Checking Network Traffic	194
12.3 Configuring Network Detection	195
12.3.1 Testing Network Delay and Packet Loss	195
12.3.2 Exporting Network Packet.....	196
12.3.3 Checking Network Status	196
12.3.4 Checking Network Statistics	197

Chapter 13 RAID	199
13.1 Configuring Array	199
13.1.2 Enable RAID	200
13.1.3 One-touch Configuration	201
13.1.4 Manually Creating Array	202
13.2 Rebuilding Array	204
13.2.2 Automatically Rebuilding Array.....	205
13.2.3 Manually Rebuilding Array	205
13.3 Deleting Array	206
13.4 Checking and Editing Firmware	207
Chapter 14 HDD Management	208
14.1 Initializing HDDs	208
14.2 Managing Network HDD	209
14.3 Managing HDD Group	211
14.3.1 Setting HDD Groups	211
14.3.2 Setting HDD Property	213
14.4 Configuring Quota Mode	214
14.5 Configuring Cloud Storage	215
14.6 Configuring Disk Clone	217
14.7 Checking HDD Status.....	219
14.8 Checking S.M.A.R.T Information	220
14.9 Detecting Bad Sector	220
14.10 Configuring HDD Error Alarms	221
Chapter 15 Camera Settings	223
15.1 Configuring OSD Settings	223
15.2 Configuring Privacy Mask.....	224
15.3 Configuring Video Parameters	225
15.3.1 Configuring Image Settings	225
15.3.2 Configuring Camera Parameters Settings	227
Chapter 16 DVR Management and Maintenance.....	229
16.1 Viewing System Information.....	229
16.2 Searching Log Files	229
16.3 Importing/Exporting IP Camera Info.....	232
16.4 Importing/Exporting Configuration Files	232

16.5 Upgrading System.....	233
16.5.1 Upgrading by Local Backup Device.....	233
16.5.2 Upgrading by FTP	233
16.6 Upgrading Camera.....	233
16.7 Restoring Default Settings.....	234
Chapter 17 Others	235
17.1 Configuring General Settings	235
17.2 Configuring RS-232 Serial Port	237
17.3 Configuring DST Settings	237
17.4 Configuring More Settings	238
17.5 Managing User Accounts.....	239
17.5.1 Adding a User	239
17.5.2 Deleting a User	242
17.5.3 Editing a User	243
Chapter 18 Appendix	246
18.1 Glossary.....	247
18.2 Troubleshooting	248
18.3 List of Applicable Power Adapter	250

Chapter 1 Introduction

1.1 Front Panel

Front Panel 1:

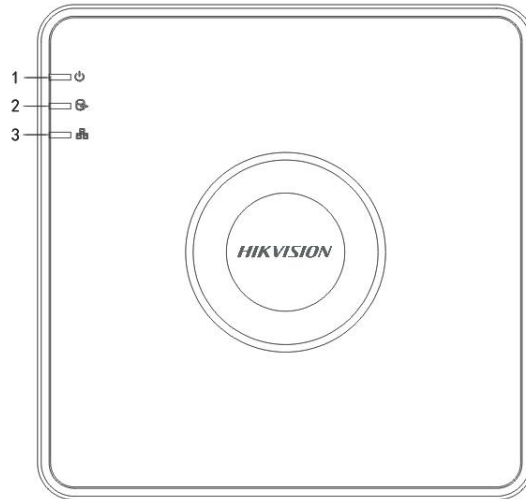

Figure 1-1 Front Panel of DS-7100HQHI-K1

Table 1-1 DS-7100HQHI-K1 Front Panel Description

No.	Icon	Description
1		Turns red when DVR is powered up.
2		Turns red when data is being read from or written to HDD.
3		Flickers blue when network connection is functioning properly.

Front Panel 2:

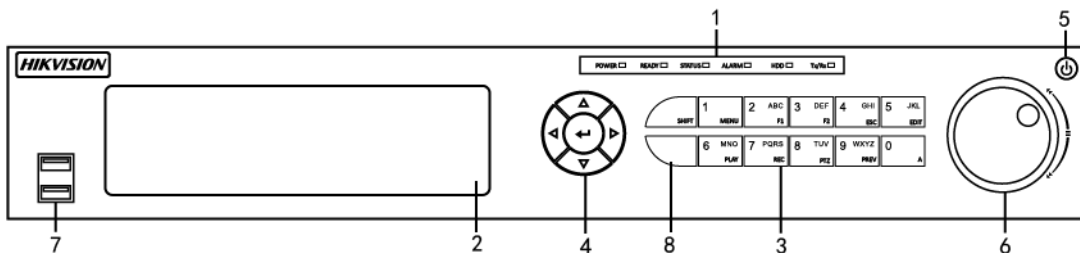

Figure 1-2 Front Panel of DS-7300HQHI-K4 and DS-7300HUHI-K4

Table 1-2 DS-7300HQHI-K4 Front Panel Description

No.	Name	Function Description
1	POWER	Turns green when DVR is powered up.
	READY	Turns green, indicating that the DVR is functioning properly.

No.	Name		Function Description
	STATUS		Turns green when device is controlled by an IR remote.
			Turns red when controlled by a keyboard and purple when IR remote and keyboard is used at the same time.
	ALARM		Turns red when a sensor alarm is detected.
	HDD		Flickers in red when data is being read from or written to HDD.
	Tx/Rx		Flickers in green when network connection is functioning properly.
2	DVD-R/W		Slot for DVD-R/W.
3	Composite Keys	SHIFT	Switches between the numeric or letter input and functions of the composite keys. (Input letter or numbers when the light is out; Realize functions when the light is red.)
		1/MENU	Enters numeral "1"; Accesses the main menu interface.
		2/ABC/F1	Enters numeral "2";
			Enters letters "ABC";
			The F1 button when used in a list field will select all items in the list;
			Turns on/off PTZ light in PTZ Control mode, and use it to zoom out the image;
			Switches between main and spot video output in live view or playback mode.
		3/DEF/F2	Enters numeral "3";
			Enters letters "DEF";

No.	Name	Function Description	
		Uses the F2 button is used to change the tab pages;	
		Zooms in the image in PTZ control mode.	
		4/GHI/ESC	Enters numeral "4";
			Enters letters "GHI";
			Exits and back to the previous menu.
		5/JKL/EDIT	Enters numeral "5";
			Enters letters "JKL";
			Deletes characters before cursor;
			Check the checkbox and select the ON/OFF switch;
			Starts/stops record clipping in playback.
		6/MNO/PLAY	Enters numeral "6";
			Enters letters "MNO";
			Accesses to playback interface in Playback mode.
		7/PQRS/REC	Enters numeral "7";
			Enters letters "PQRS";
			Accesses to manual record interface;
			Manually enables/disables record.
		8/TUV/PTZ	Enters numeral "8";
			Enters letters "TUV";
			Accesses PTZ control interface.
9/WXYZ/PREV	Enters numeral "9";		

No.	Name		Function Description
			Enters letters “WXYZ”;
			Multi-channel display in live view.
		O/A	Enters numeral “0”;
		Shifts the input methods in the editing text field. (Upper and lowercase, alphabet, symbols or numeric input).	
4	DIRECTION		Navigates between different fields and items in menus.
			Uses the Up and Down buttons to speed up and slow down the playing of video files in Playback mode. The Left and Right button will select the next and previous record files.
			Cycles through channels in Live View mode.
			Controls the movement of the PTZ camera in PTZ control mode.
	ENTER		Confirms selection in any of the menu modes.
			Checks the checkbox.
			Plays or pauses the playing of video files in Playback mode.
			Advances the video by a single frame in single-frame Playback mode.
			Stops/starts auto switch in Auto-switch mode.
	5	POWER	
6	JOG SHUTTLE Control		Moves the active selection up and down in a menu.
			Cycles through different channels in live view mode.

No.	Name	Function Description
		Jumps 30s forward/backward in video files in the playback mode.
		Controls the movement of the PTZ camera in PTZ control mode.
		Moves the active selection up and down in a menu.
7	USB Interface	Universal Serial Bus (USB) ports for additional devices such as USB mouse and USB Hard Disk Drive (HDD).
8	IR Receiver	Receiver for IR remote control.

Front Panel 3

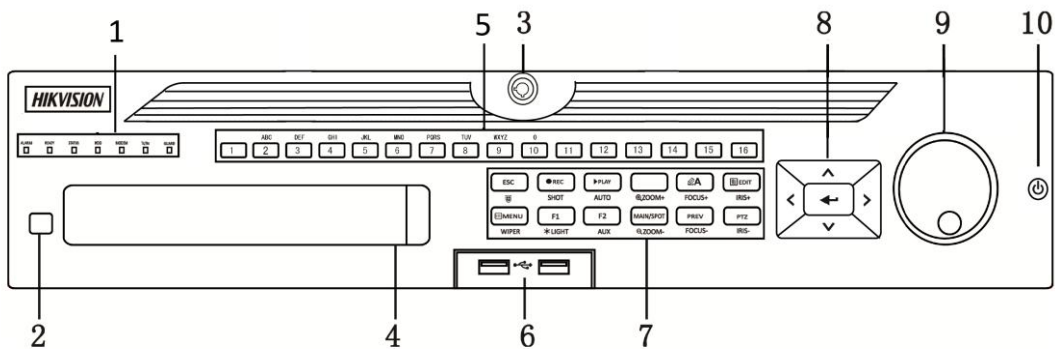

Figure 1-3 Front Panel of DS-9000HUHI-K8

Table 1-3 DS-9000HUHI-K8 Front Panel Description

No.	Name	Function Description
1	ALARM	Turns red when a sensor alarm is detected.
	READY	Turns blue, indicating that the DVR is functioning properly.
	STATUS	Turns blue when device is controlled by an IR remote.
		Turns red when controlled by a keyboard and purple when IR remote and keyboard is used at the same time.
	HDD	Flickers in red when data is being read from or written to HDD.

	MODEM	Flickers in blue when network connection is functioning properly.
	Tx/Rx	Turns blue when the device is in armed status; at this time, an alarm is enabled when an event is detected.
	GUARD	Turns off when the device is unarmed. The arm/disarm status can be changed by pressing and holding on the ESC button for more than 3 seconds in live view mode.
Turns red when a sensor alarm is detected.		
2	IR Receiver	Receiver for IR remote
3	Front Panel Lock	Lock or unlock the panel by the key.
4	DVD-R/W	Slot for DVD-R/W.
5	Alphanumeric Buttons	Switches to the corresponding channel in live view or PTZ control mode.
		Inputs numbers and characters in edit mode.
		Switches between different channels in playback mode.
		Turns blue when the corresponding channel is recording; turns red when the channel is in network transmission status; turns pink when the channel is recording and transmitting.
6	USB Interfaces	Universal Serial Bus (USB) ports for additional devices such as USB mouse and USB Hard Disk Drive (HDD).
7	ESC	Returns to the previous menu.
		Presses for arming/disarming the device in live view mode.
	REC/SHOT	Enters the Manual Record settings menu.
		Presses this button followed by a numeric button to call a PTZ preset in PTZ control settings.
		Turns audio on/off in the playback mode.
PLAY/AUTO	Enters the playback mode.	

		Automatically scans in the PTZ control menu.
	ZOOM+	Zooms in the PTZ camera in the PTZ control setting.
	A/FOCUS+	Adjusts focus in the PTZ Control menu.
		Switches between input methods (upper and lower case alphabet, symbols and numeric input).
	EDIT/IRIS+	Edits text fields. When editing text fields, it also deletes the character in front of the cursor.
		Checks the checkbox in the checkbox fields.
		Adjusts the iris of the camera in PTZ control mode.
		Generates video clips for backup in playback mode.
		Enters/exits the folder of USB device and eSATA HDD.
	MAIN/SPOT/ZOOM-	Switches between main and spot output.
		Zooms out the image in PTZ control mode.
	F1/ LIGHT	Selects all items on the list when used in a list field.
		Turns on/off PTZ light (if applicable) in PTZ control mode.
		Switches between play and reverse play in playback mode.
	F2/ AUX	Cycles through tab pages.
		Switches between channels in synchronous playback mode.
	MENU/WIPER	Returns to the Main menu (after successful login).
		Presses and holds the button for five seconds to turn off audible key beep.
		Starts wiper (if applicable) in PTZ control mode.
		Shows/hides the control interface in playback mode.

	PREV/FOCUS-	Switches between single screen and multi-screen mode.
		Adjusts the focus in conjunction with the A/FOCUS+ button in PTZ control mode.
	PTZ/IRIS-	Enters the PTZ Control mode.
		Adjusts the iris of the PTZ camera in PTZ control mode.
8	DIRECTION	Navigates between different fields and items in menus.
		Uses the Up and Down buttons to speed up and slow down the playing of video files in Playback mode.
		The Left and Right button will select the next and previous record files.
		Cycles through channels in Live View mode.
		Controls the movement of the PTZ camera in PTZ control mode.
	ENTER	Confirms selection in any of the menu modes.
		Checks the checkbox.
		Plays or pauses the playing of video files in Playback mode.
		Advances the video by a single frame in single-frame Playback mode.
		Stops/starts auto switch in Auto-switch mode.
9	JOG SHUTTLE Control	Moves the active selection up and down in a menu.
		Cycles through different channels in live view mode.
		Jumps 30s forward/backward in video files in the playback mode.
		Controls the movement of the PTZ camera in PTZ control mode.
10	POWER ON/OFF	Power on/off switch.

Front Panel 4:

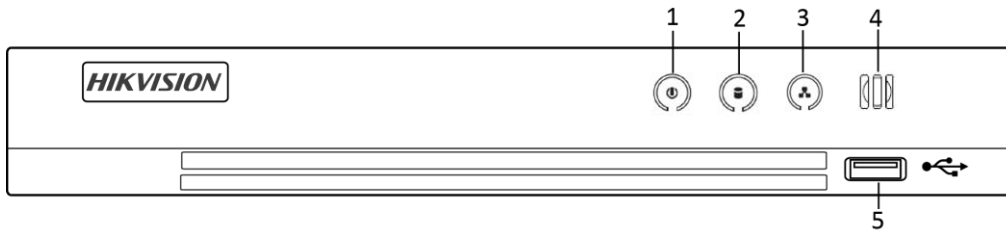

Figure 1-4 Front Panel of Other Models

Table 1-4 Front Panel of Other Models Description

No.	Icon	Description
1		Turns white when DVR is powered up.
2		Turns red when data is being read from or written to HDD.
3		Flashes white when the network is well-connected.
4		Receiver for IR remote control.
5	USB Interface	Universal Serial Bus (USB) ports for additional devices such as USB mouse and USB Hard Disk Drive (HDD).

1.2 IR Remote Control Operations

The DVR may also be controlled with the included IR remote control, shown in Figure 1-2.

NOTE

Batteries (2×AAA) must be installed before operation.

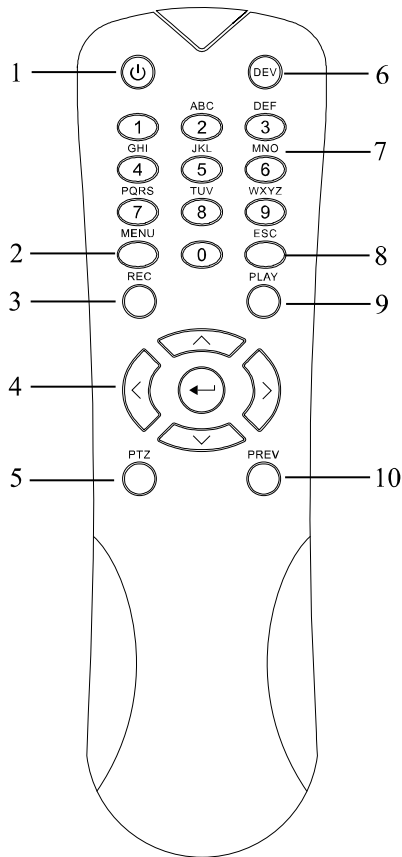

Figure 1-5 Remote Control

The keys on the remote control closely resemble the ones found on the front panel. Refer to Table 1-5, they include:

Table 1-5 Description of the IR Remote Control Buttons

No.	Name	Description
1	POWER	Power on/off the device.
		Power on/off the device by pressing and holding the button for 5 seconds.
2	MENU Button	Press the button to return to the main menu (after successful login).
		Press and hold the button for 5 seconds will turn off audible key beep.
		In PTZ Control mode, the MENU button will start wiper (if applicable).
		In Playback mode, it is used to show/hide the control interface.
3	REC Button	Enter the Manual Record setting menu.

No.	Name	Description
		In PTZ control settings, press the button and then you can call a PTZ preset by pressing Numeric button.
		It is also used to turn audio on/off in the Playback mode.
4	DIRECTION Button	Navigate between different fields and items in menus.
		In the Playback mode, the Up and Down button is used to speed up and slow down recorded video. The Left and Right button will select the next and previous record files.
		In Live View mode, these buttons can be used to cycle through channels.
		In PTZ control mode, it can control the movement of the PTZ camera.
	ENTER Button	Confirm selection in any of the menu modes.
		It can also be used to <i>tick</i> checkbox fields.
		In Playback mode, it can be used to play or pause the video.
		In single-frame Playback mode, pressing the button will advance the video by a single frame.
5	PTZ Button	In Auto-switch mode, it can be used to stop /start auto switch.
6	DEV	Enables/Disables Remote Control.
7	Alphanumeric Buttons	Switch to the corresponding channel in Live view or PTZ Control mode.
		Input numbers and characters in Edit mode.
		Switch between different channels in the Playback mode.
8	ESC Button	Back to the previous menu.
		Press for Arming/disarming the device in Live View mode.
9	PLAY Button	The button is used to enter the All-day Playback mode.

No.	Name	Description
		It is also used to auto scan in the PTZ Control menu.
10	PREV Button	Switch between single screen and multi-screen mode.
		In PTZ Control mode, it is used to adjust the focus in conjunction with the A/FOCUS+ button.

Troubleshooting Remote Control:



Make sure you have installed batteries properly in the remote control. And you have to aim the remote control at the IR receiver on the front panel.

If there is no response after you press any button on the remote, follow the procedure below to troubleshoot.

Step 1 Go to **Menu > Configuration > General > More Settings** by operating the front control panel or the mouse.

Step 2 Check and remember the DVR No. The default DVR No. is 255. This number valid for all IR remote controls.

Step 3 Press **DEV** on the remote control.

Step 4 Enter the DVR No. in step 2.

Step 5 Press **ENTER** on the remote.

If the Status indicator on the front panel turns blue, the remote control is operating properly. If the Status indicator does not turn blue and there is still no response from the remote, please check the following:

Step 1 Batteries are installed correctly and the polarities of the batteries are not reversed.

Step 2 Batteries are fresh and not out of charge.

Step 3 IR receiver is not obstructed.

If the remote still cannot function properly, please change the remote and try again, or contact the device provider.

1.3 USB Mouse Operation

A regular 3-button (Left/Right/Scroll-wheel) USB mouse can also be used with this DVR. To use a USB mouse:

Step 1 Plug USB mouse into one of the USB interfaces on the front panel of the DVR.

Step 2 The mouse should automatically be detected. If in a rare case that the mouse is not detected, the possible reason may be that the two devices are not compatible, please refer to the recommended the device list from your provider.

The operation of the mouse:

Table 1-6 Description of the Mouse Control

Name	Action	Description
Left-Click	Single-Click	Live view: Select channel and show the quick set menu. Menu: Select and enter.
	Double-Click	Live view: Switch between single-screen and multi-screen.
	Drag	PTZ control: Wheeling. Privacy mask and motion detection: Select target area. Digital zoom-in: Drag and select target area. Live view: Drag channel/time bar.
Right-Click	Single-Click	Live view: Show menu. Menu: Exit current menu to upper level menu.
Scroll-Wheel	Scrolling up	Live view: Previous screen. Menu: Previous item.
	Scrolling down	Live view: Next screen. Menu: Next item.

1.4 Input Method Description



Figure 1-6 Soft Keyboard

Description of the buttons on the soft keyboard:

Table 1-7 Description of the Soft Keyboard Icons

Icon	Description	Icon	Description
	Number		English letter
	Lowercase/Uppercase		Backspace
	Switch the keyboard		Space
	Positioning the cursor		Enter
	Symbols		Reserved

1.5 Rear Panel



NOTE

The rear panel varies according to different models. Please refer to the actual product. The following figures are for reference only.

Rear Panel 1:

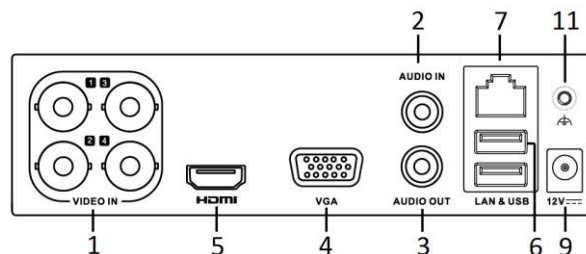

Figure 1-7 Rear Panel of DS-710HQHI-K1

Rear Panel 2:

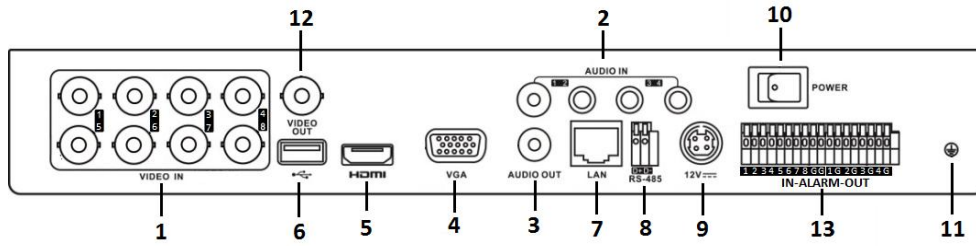

Figure 1-8 Rear Panel of DS-7200HUHI-K

Rear Panel 3:

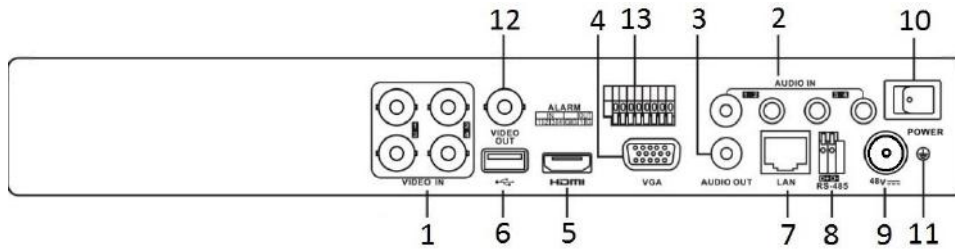

Figure 1-9 Rear Panel of DS-7200HUHI-K/P

Rear Panel 4:

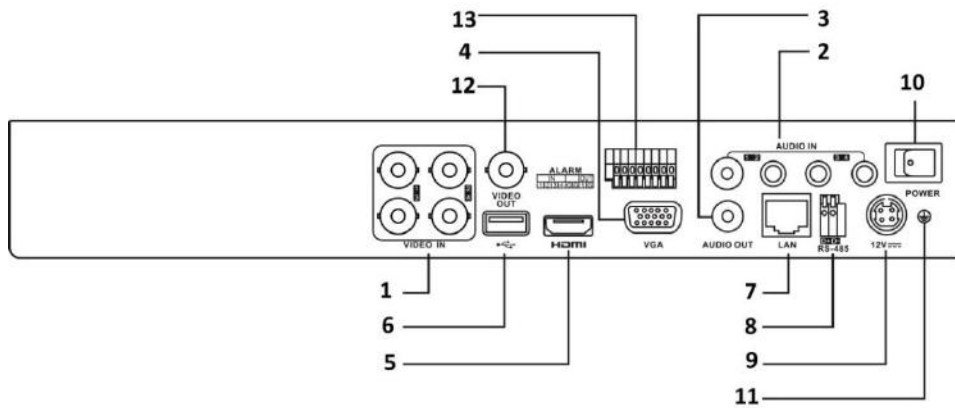

Figure 1-10 Rear Panel of DS-7200HTHI-K1

Rear Panel 5:

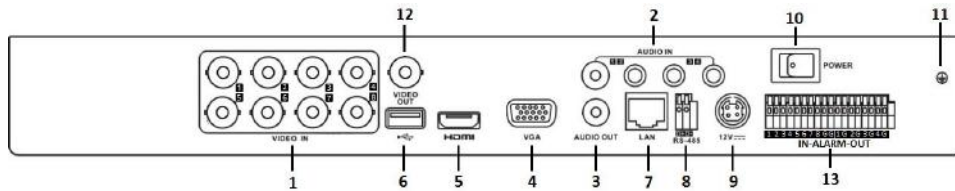

Figure 1-11 Rear Panel of DS-7200HTHI-K2

Rear Panel 6:

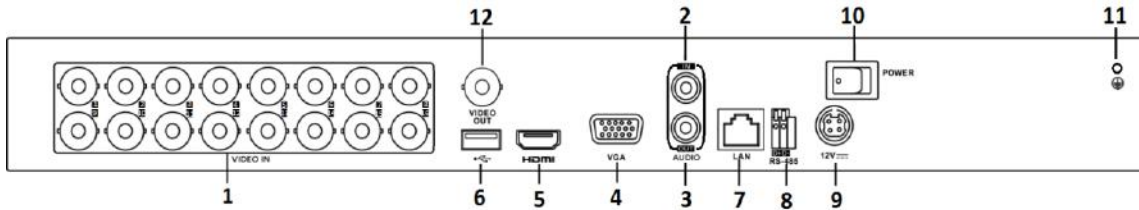

Figure 1-12 Rear Panel of DS-7200HQHI-K

Rear Panel 7:

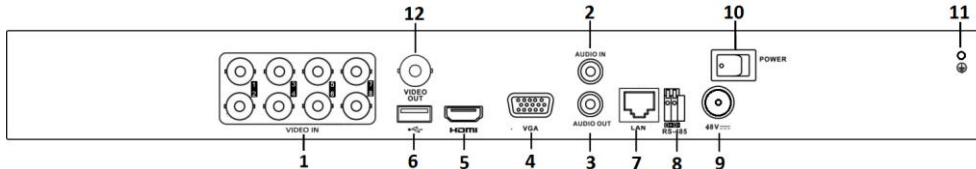

Figure 1-13 Rear Panel of DS-7200HQHI-K/P

Table 1-8 Description of Rear Panel 1-7

No.	Item	Description
1	VIDEO IN	BNC interface for Turbo HD and analog video input.
2	AUDIO IN	RCA connector
3	AUDIO OUT	RCA connector.
4	VGA	DB15 connector for VGA output. Display local video output and menu.
5	HDMI	HDMI video output connector.
6	USB Interface	Universal Serial Bus (USB) port for additional devices.
7	Network Interface	Connector for network
8	RS-485 Interface	Connector for RS-485 devices.
9	Power Supply	48 VDC or 12 VDC.
10	Power Switch	Switch for turning on/off the device.
11	GND	Ground
12	VIDEO OUT	BNC connector for video output.

No.	Item	Description
13	Alarm In/Out	Connector for alarm input and output.

Rear Panel 8:

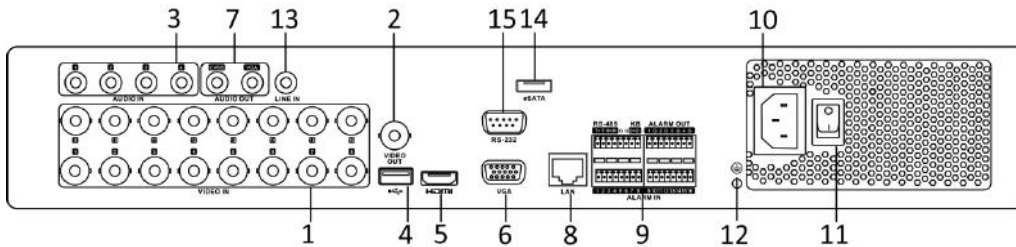

Figure 1-14 Rear Panel of DS-7300HQHI-K

Table 1-9 Description of DS-7300HQHI-K Rear Panel

No.	Item	Description
1	VIDEO IN	BNC interface for Turbo HD and analog video input.
2	VIDEO OUT	BNC connector for video output.
3	AUDIO IN	RCA connector
4	USB Port	Universal Serial Bus (USB) port for additional devices.
5	HDMI	HDMI video output connector.
6	VGA	DB15 connector for VGA output. Display local video output and menu.
7	AUDIO OUT	RCA connector.
8	Network Interface	Connector for network
9	RS-485 and Alarm Interface	Connector for RS-485 devices. T+ and T- pins connect to R+ and R- pins of PTZ receiver respectively.
		D+, D- pin connects to Ta, Tb pin of controller. For cascading devices, the first DVR's D+, D- pin should be connected with the D+, D- pin of the next DVR.

No.	Item	Description
		Connector for alarm input.
		Connector for alarm output.
10	Power Supply	100 to 240 VAC power supply.
11	Power Switch	Switch for turning on/off the device.
12	GND	Ground
13	LINE IN	BNC connector for audio input.
14	eSATA	Connects external SATA HDD, CD/DVD-RW.
15	RS-232 Interface	Connector for RS-232 devices.

Rear Panel 9:

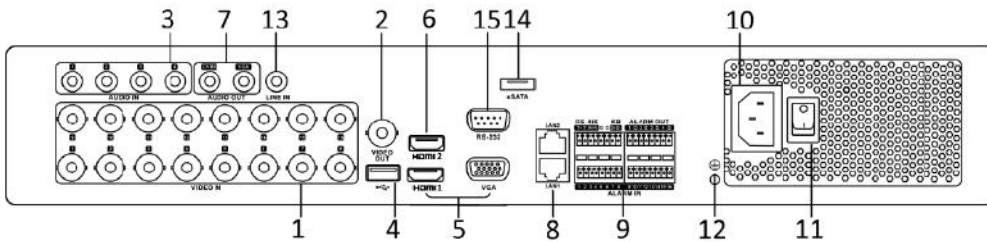

Figure 1-15 Rear Panel of DS-7300HUHI-K4

Rear Panel 10:

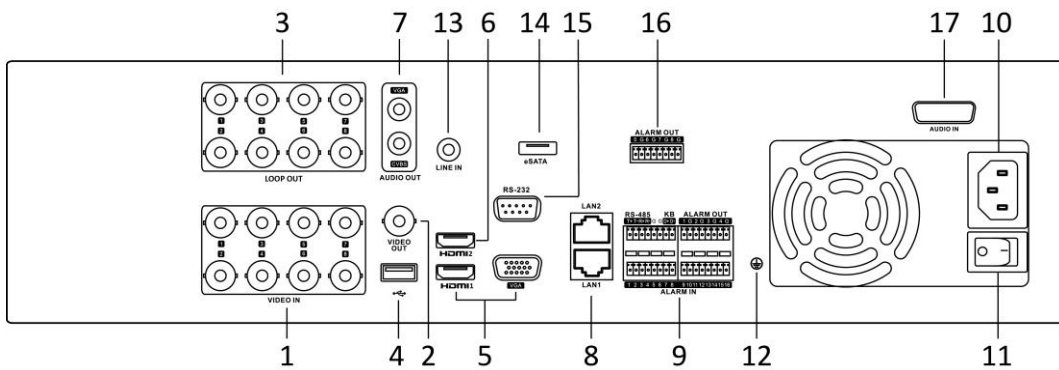

Figure 1-16 Rear Panel of DS-9000HUHI-K8

Table 1-10 Description of DS-7300HUHI-K4/DS-9000HUHI-K8 Rear Panel

No.	Item	Description
1	VIDEO IN	BNC interface for Turbo HD and analog video input.
2	VIDEO OUT	BNC connector for video output.
3	AUDIO IN/ LOOP OUT (for DS-9000HUHI-K8)	RCA connector
4	USB Port	Universal Serial Bus (USB) port for additional devices.
5	HDMI1/VGA	Simultaneous HDMI1/VGA output. Display local video output and menu.
6	HDMI2	HDMI2 video output connector.
7	AUDIO OUT	RCA connector.
8	Network Interface	Connector for network
9	RS-485 and Alarm Interface	Connector for RS-485 devices. T+ and T- pins connect to R+ and R- pins of PTZ receiver respectively.
		D+, D- pin connects to Ta, Tb pin of controller. For cascading devices, the first DVR's D+, D- pin should be connected with the D+, D- pin of the next DVR.
		Connector for alarm input.
		Connector for alarm output.
10	Power Supply	100 to 240 VAC power supply.
11	Power Switch	Switch for turning on/off the device.
12	GND	Ground
13	LINE IN	BNC connector for audio input.
14	eSATA	Connects external SATA HDD, CD/DVD-RW.

No.	Item	Description
15	RS-232 Interface	Connector for RS-232 devices.
16	ALARM OUT	Connector for alarm output.
17	AUDIO IN (for DS-9000HUHI-K8)	RCA connector

Chapter 2 Getting Started

2.1 Starting Up and Shutting Down the DVR

Purpose

Proper startup and shutdown procedures are crucial to expanding the life of the DVR.

Before you start

Check that the voltage of the extra power supply is the same with the DVR's requirement, and the ground connection is working properly.

Starting up the DVR

Step 1 Check the power supply is plugged into an electrical outlet. It is HIGHLY recommended that an Uninterruptible Power Supply (UPS) be used in conjunction with the device.

Step 2 Turn on the power switch on the rear panel, and the Power indicator LED should turn on indicating that the unit begins to start up.

Step 3 After startup, the Power indicator LED remains on.

Shutting down the DVR

Step 1 Go to **Menu > Shutdown**.



Figure 2-1 Shutdown Menu

Step 2 Click **Shutdown**.

Step 3 Click **Yes**.

Step 4 Turn off the power switch on the rear panel when the note appears.

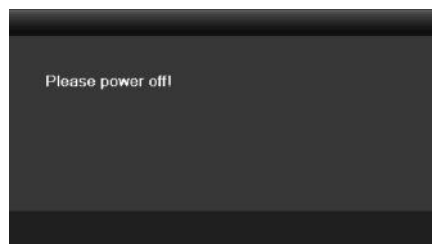

Figure 2-2 Shutdown Tips

Rebooting the DVR

While in the Shutdown menu (Figure 2-1), you can also reboot the DVR.

Step 1 Go to **Menu > Shutdown**.

Step 2 Click **Logout** to log out or **Reboot** to reboot the DVR.

2.2 Activating the Device

Purpose

For the first-time access, you need to activate the device by setting an admin password. No operation is allowed before activation. You can also activate the device via Web Browser, SADP or Client Software.

Step 1 Input the same password in **Create New Password** and **Confirm New Password**.

Step 2 In **IP Camera Activation**, enter the password to activate the IP camera (s) connected to the device.

Step 3 (Optional) Check **Security Question Configuration** to enable security questions for password resetting.

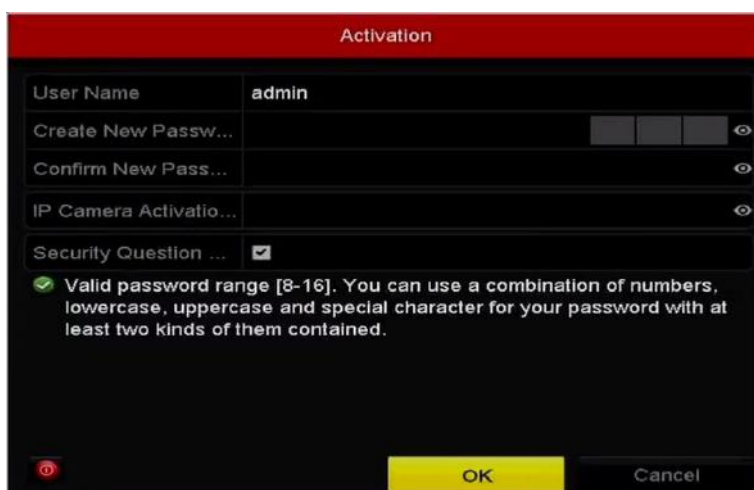



Figure 2-3 Settings Admin Password

WARNING

STRONG PASSWORD RECOMMENDED-We highly recommend you create a strong password of your own choosing (Using a minimum of 8 characters, including at least three of the following categories: upper case letters, lower case letters, numbers, and special characters.) in order to increase the security of your product. And we recommend you reset your password regularly, especially in the high security system, resetting the password monthly or weekly can better protect your product.

Step 4 Click **OK** to save the password and activate the device.

 NOTE

- Clear-text password is supported. Click the  icon and you can see the clear text of the password. Click the icon again and the content of the password restores invisible.
- For the old version device, if you update it to the new version, the following dialog box will pop up once the device starts up. You can click **YES** and follow the wizard to set a strong password.

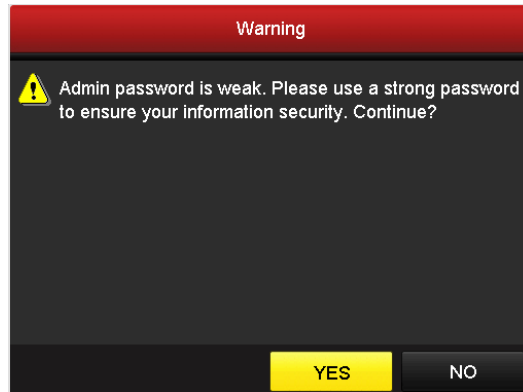

Figure 2-4 Warning

Step 5 (Optional) A prompt of Security Questions Configuration pops up if **Security Questions Configuration** checked.

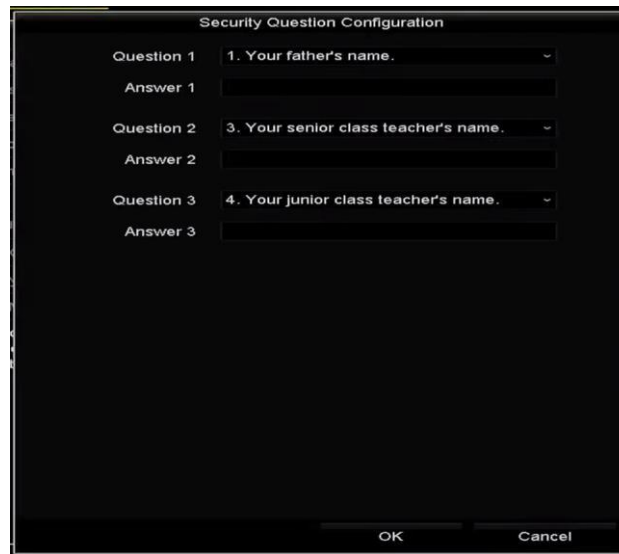

Figure 2-5 Security Question Configuration

- 1) Select three security questions from the drop-down list and input the answers.
- 2) Click **OK**.
- 3) A prompt of attention pops up as shown as figure 2-5.



Figure 2-6 Attention

4) Click **OK**.

Step 6 After security questions has been configured, the **Attention** box pops up as below.



Figure 2-7 Attention

Step 7 (Optional) Click **Yes** to export GUID. The Reset Password interface pops up. Click **Export** to export GUID to the USB flash drive for password resetting.

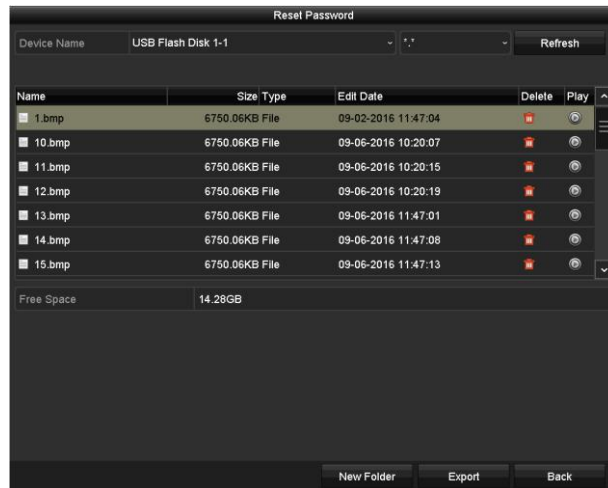

Figure 2-8 Export GUID

Step 8 After exporting GUID, the Attention box pops up as below. Click **Yes** to duplicate the password or **No** to cancel it.



Figure 2-9 Duplicate the Password

2.3 Using the Unlock Pattern for Login

Purpose

For the *admin*, you can configure the unlock pattern for device login.

2.3.1 Configuring the Unlock Pattern

After the device is activated, you can enter the following interface to configure the device unlock pattern.

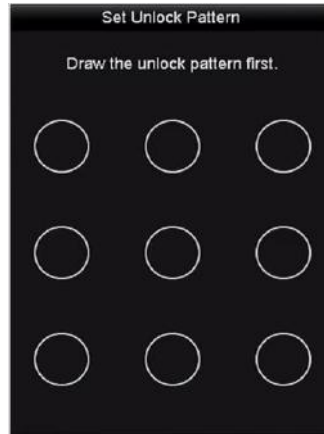

Figure 2-10 Set Unlock Pattern

Step 1 Use the mouse to draw a pattern among the 9 dots on the screen. Release the mouse when the pattern is done.

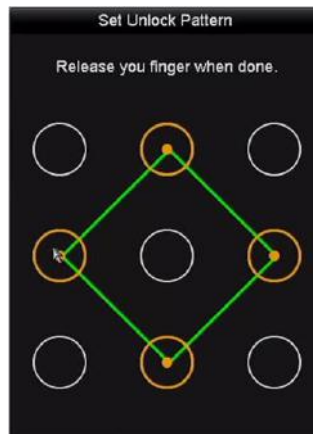

Figure 2-11 Draw the Pattern

 **NOTE**

- Connect at least 4 dots to draw the pattern.
- Each dot can be connected for once only.

Step 2 Draw the same pattern again to confirm it. When the two patterns match, the pattern is configured successfully.

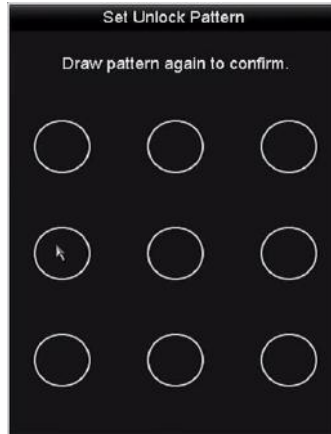

Figure 2-12 Confirm the Pattern

 **NOTE**

If the two patterns are different, you must set the pattern again.

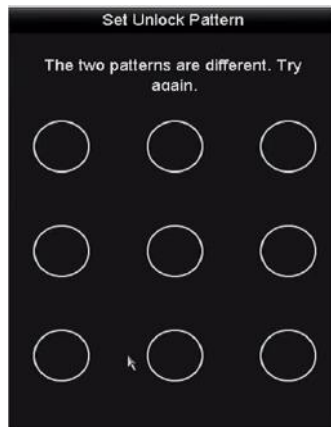

Figure 2-13 Reset the Pattern

2.3.2 Logging in via Unlock Pattern

 **NOTE**

- Only the *admin* user has the permission to unlock the device.
- Please configure the pattern first before unlocking. Please refer to *Chapter 2.3.1 Configuring the Unlock Pattern*.

Step 1 Right click the mouse on the screen and select the menu to enter the interface.

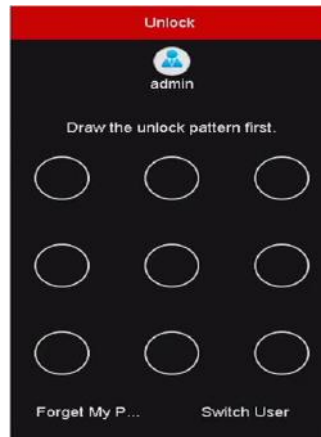

Figure 2-14 Draw the Unlock Pattern

Step 2 Draw the pre-defined pattern to unlock to enter the menu operation.

 **NOTE**

- You can right click the mouse to log in via the normal mode.
- If you have forgotten your pattern, you can select **Forget My Pattern** or **Switch User** option to enter the normal login dialog box.
- When the pattern you draw is different from the pattern you have configured, you should try again.
- If you have drawn the wrong pattern for 7 times, the account will be locked for 1 minute.

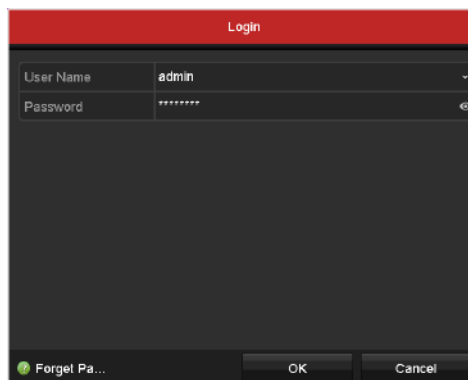

Figure 2-15 Normal Login Dialog Box

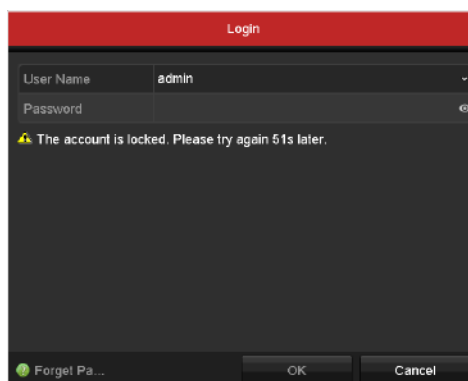

Figure 2-16 Lock the Account

2.4 Basic Configuration in Startup Wizard

Purpose

By default, **Setup Wizard** starts once the device has loaded. You can follow it to complete the basic configuration.

Selecting the language:

Step 1 Select the language from the drop-down list.

Step 2 Click **Apply**.

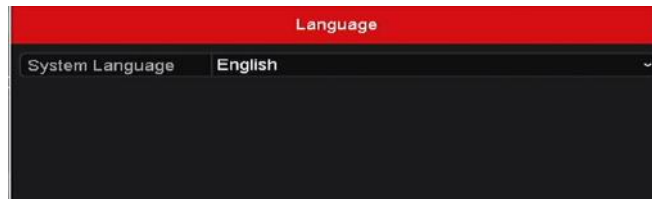

Figure 2-17 Language Configuration

Operating the Setup Wizard:

Step 1 **Start Wizard** can walk you through some important settings of the device. If you don't want to use the **Start Wizard** at that moment, click **Exit**. You can also choose to use the **Start Wizard** next time by leaving the "Start wizard when device starts?" checkbox checked.

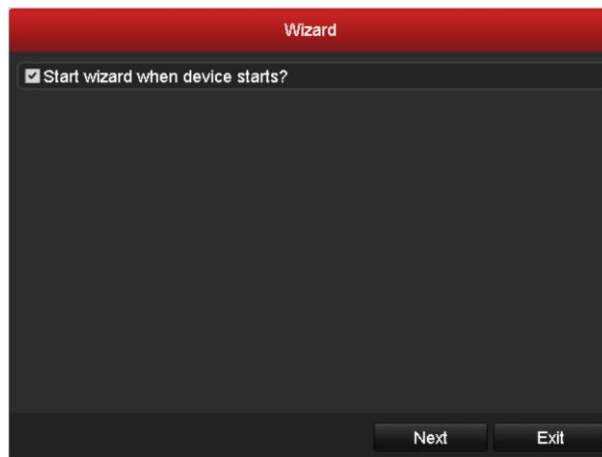



Figure 2-18 Start Wizard Interface

Step 2 Click **Next** to enter the **Change the Password** interface.

- 1) Input **Admin Password**.
- 2) (Optional) Check **New Admin Password**, input **New Password** and confirm it.

- 3) (Optional) Check **Enable Pattern Unlock** and draw the unlock pattern. Or click  of **Draw Unlock Pattern** to change the pattern. Refer to *Chapter 2.3 Using the Unlock Pattern for Login* for reference.
- 4) (Optional) Click  of **Export GUID** to export GUID to the connected USB flash drive for resetting password. Refer to *Chapter 17.5.3 Editing a User* for reference.

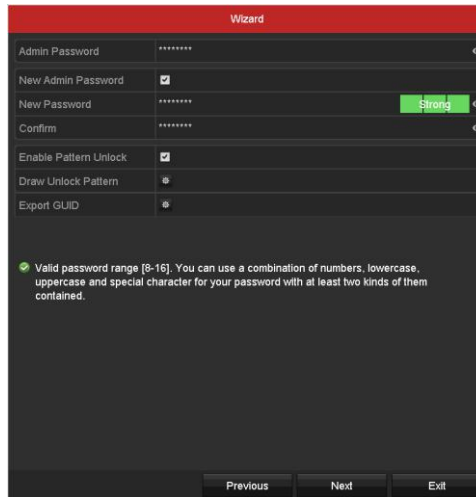

Figure 2-19 Change the Password

Step 3 Click **Next** and the Attention box pops up as shown below. Click **Yes** to duplicate the password of the device to IP cameras that are connected with default protocol. Or click **No** to enter the **Date and Time Settings** interface.



Figure 2-20 Duplicate the Password



Figure 2-21 Date and Time Settings

Step 4 After the time settings, click **Next** to enter the **General Network Setup Wizard** interface as shown below.

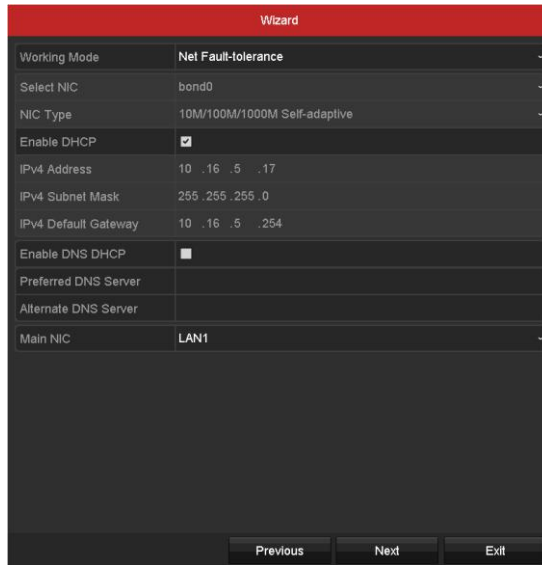

Figure 2-22 General Network Configuration

Step 5 Click **Next** after you configured the basic network parameters.

Then you will enter the **Hik-Connect** interface. Configure the Hik-Connect according to your need. Refer to *Chapter 12.2.2 Configuring Hik-Connect* for detailed operations.

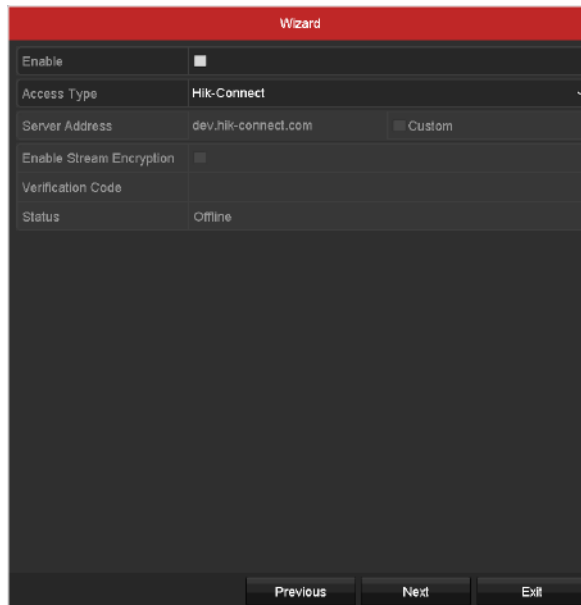

Figure 2-23 Hik-Connect Configuration

Step 6 Click **Next** to enter the **Advanced Network Parameters** interface. You can enable DDNS and set other ports according to your need.

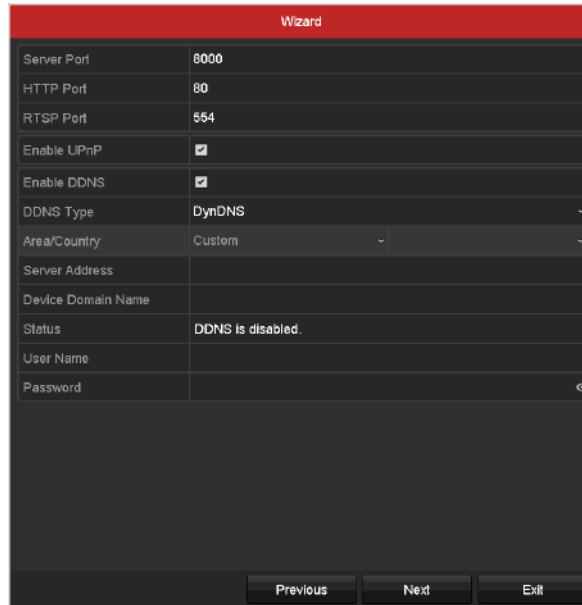

Figure 2-24 Set Advanced Network Parameters

Step 7 For DS-7300/9000HUHI-K series, click **Next** and you can enter the RAID configuration interface. Check **Enable RAID** to take this function into effect.

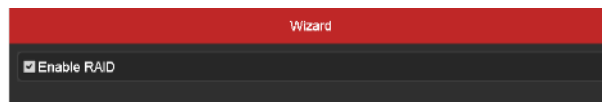

Figure 2-25 RAID Configuration

Step 8 Click **Next** after configuring the advanced network parameters, which will take you to the **HDD Management** interface as shown below.

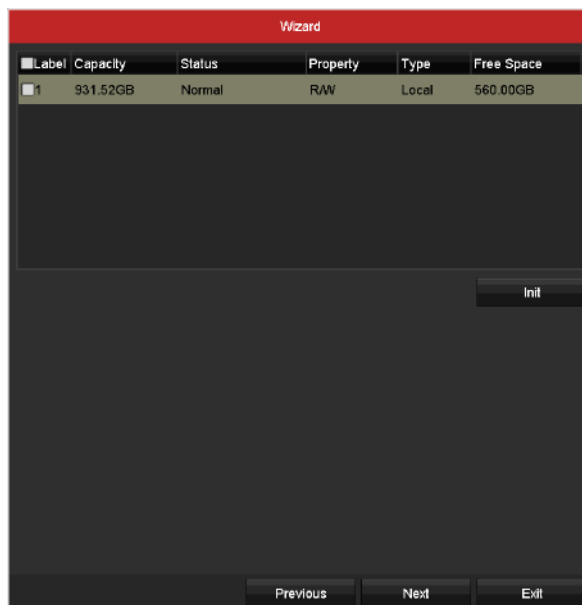

Figure 2-26 HDD Management

Step 9 To initialize the HDD, click **Init**. Initialization will remove all the data saved in the HDD.

Step 10 Click **Next** to enter the **IP Camera Management** interface.

Step 11 Add the IP camera.

- 1) Click **Search** to search the online IP Camera. The **Security** status shows whether it is active or inactive. Before adding the camera, make sure the IP camera to be added is in active status. If the camera is in inactive status, you can click the inactive icon of the camera to set the password to activate it. You can also select multiple cameras from the list and click **One-touch Activate** to activate the cameras in batch.
- 2) Click **Add** to add the camera.
- 3) (Optional) Check **Enable H.265 (For Initial Access)** for the connected IP camera supporting H.265. Then the IP camera will be encoded with H.265.

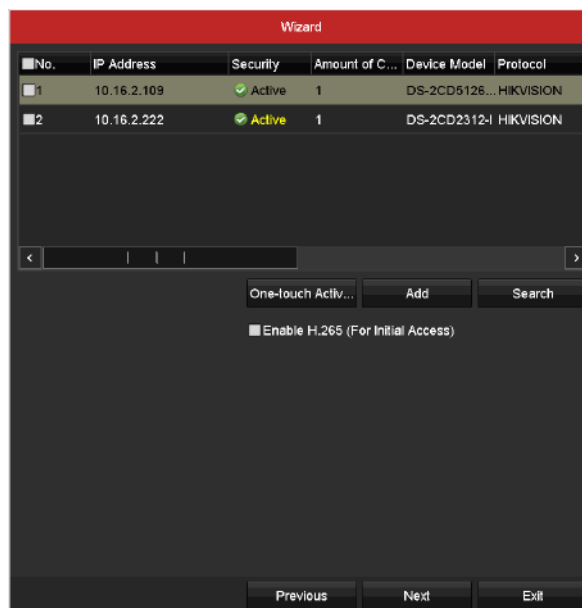

Figure 2-27 IP Camera Management

Step 12 After finishing IP Camera settings, click **Next** to enter the **Record Settings** interface.

Step 13 Click , and you can enable the continuous recording or motion detection recording for all channels of the device.



Figure 2-28 Record Settings

Step 14 Click **OK** to complete the wizard settings.

2.5 Login and Logout

2.5.1 User Login

Purpose

You have to log in to the device before operating the menu and other functions

Step 1 Select **User Name** in the drop-down list.

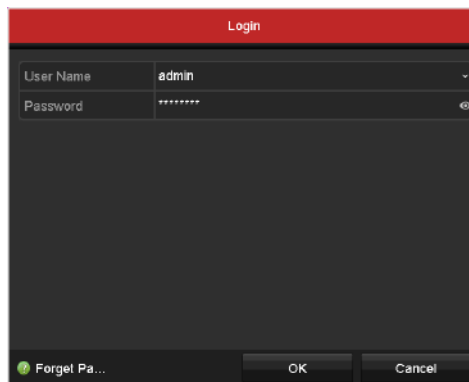

Figure 2-29 Login Interface

Step 2 Input **Password**.

Step 3 Click **OK** to log in.



NOTE

In the Login interface, for the admin, if you have entered the wrong password for 7 times, the account will be locked for 60 seconds. For the operator, if you have entered the wrong password for 5 times, the account will be locked for 60 seconds.

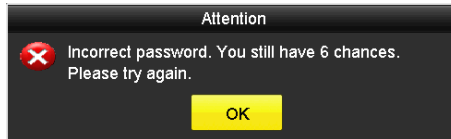

Figure 2-30 User Account Protection for the Admin

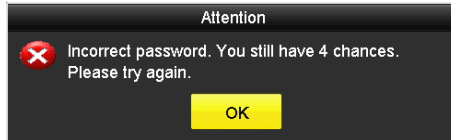

Figure 2-31 User Account Protection for the Operator

2.5.2 User Logout

Purpose

After logging out, the monitor turns to the live view mode and if you want to perform some operations, you need to enter the user name and password to log in again.

Step 1 Go to **Menu > Shutdown**.



Figure 2-32 Logout

Step 2 Click **Logout**.



After you have logged out of the system, menu operation on the screen is invalid. It is required to input a user name and password to unlock the system.

2.6 Resetting Your Password

Purpose

When you forget the password of the *admin*, you can reset the password by importing the GUID file. The GUID file must be exported and saved in the local USB flash drive after you have activated the device (refer to *Chapter 2.2 Activating the Device*).

Step 1 On the user login interface, click **Forget Password** to enter the **Password Reset Type** interface.



Figure 2-33 Password Reset Interface

- Check **Verify by GUID** to enter the Import GUID interface. Select the GUID file from the USB flash drive and click **Import** to pop up the **Reset Password** interface.

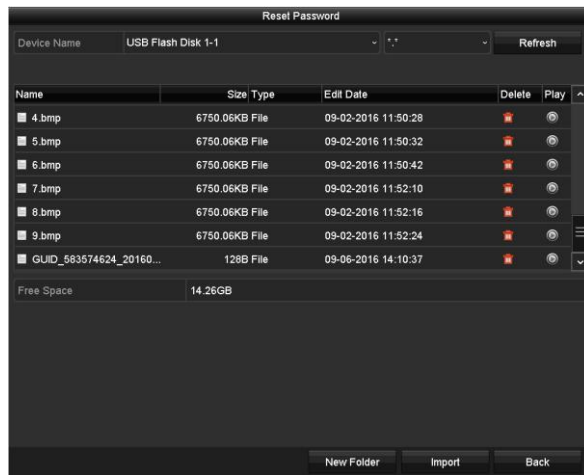

Figure 2-34 Import GUID

- Check **Verify by Security Question** to enter **Verify by Security Question** interface. Enter answers to security questions and click **OK** to pop up the **Reset Password** interface.

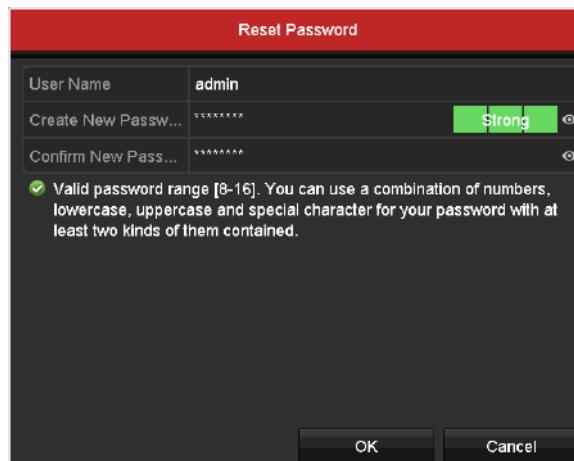

Figure 2-35 Reset Password

Step 2 Input the new password and confirm the password.

Step 3 Click **OK** to save the new password. Then the Attention box pops up as shown below.



Figure 2-36 GUID File Imported

Step 4 Click **OK** and the Attention box as below pops up to remind you to duplicate the password of the device to IP cameras that are connected with default protocol. Click **Yes** to duplicate the password or **No** to cancel it.



Figure 2-37 Duplicate the Password

NOTE

- If you want to retrieve the password when you forget it, you must export the GUID file first.
- Once the password is reset, the GUID file will be invalid. You can export a new GUID file. Refer to *Chapter 17.5.3 Editing a User* for reference.

2.7 Adding and Connecting the IP Cameras

2.7.1 Activating the IP Camera

Purpose

Before adding the camera, make sure the IP camera to be added is in active status.

Step 1 Select **Add IP Camera** from the right-click menu in live view mode or go to **Menu> Camera> IP Camera**.

For the IP camera detected online in the same network segment, the **Security** status shows whether it is active or inactive.

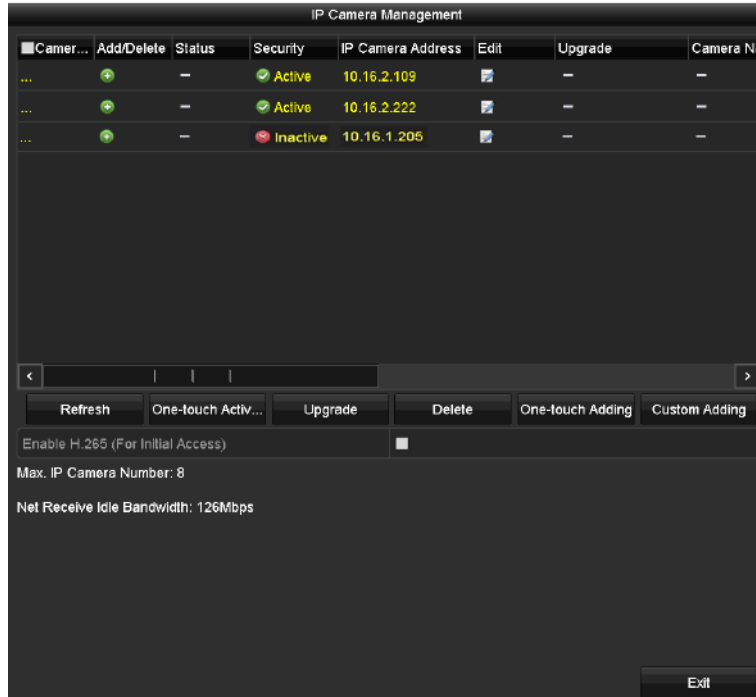

Figure 2-38 IP Camera Management Interface

Step 2 Click the inactive icon of the camera to enter the following interface to activate it. You can also select multiple cameras from the list and click **One-touch Activate** to activate the cameras in batch.

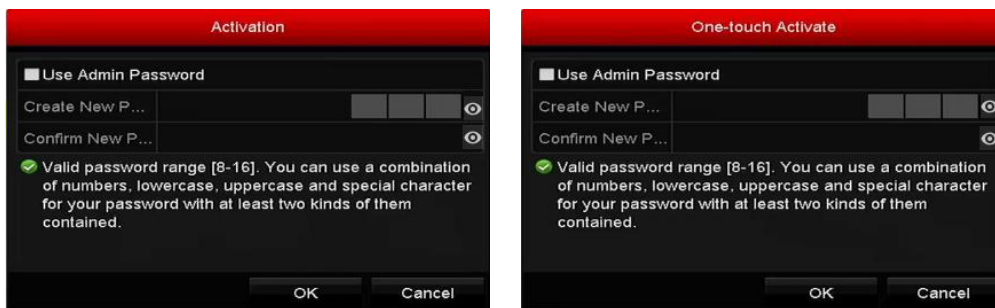

Figure 2-39 Activate the Camera

Step 3 Set the password of the camera to activate it.

Use Admin Password: When you check the checkbox, the camera (s) will be configured with the same admin password of the operating DVR.

Create New Password: If the admin password is not used, you must create the new password for the camera and confirm it.



Figure 2-40 Set New Password

 **WARNING**

STRONG PASSWORD RECOMMENDED-We highly recommend you create a strong password of your own choosing (Using a minimum of 8 characters, including at least three of the following categories: upper case letters, lower case letters, numbers, and special characters.) in order to increase the security of your product. And we recommend you reset your password regularly, especially in the high security system, resetting the password monthly or weekly can better protect your product.

Step 4 Click **OK** to finish the activation of the IP camera. And the security status of camera will be changed to **Active**.

2.7.2 Adding the Online IP Camera

Purpose

Before you can get a live view or record of the video, you should add the network cameras to the connection list of the device.

Before you start

Ensure the network connection is valid and correct. For detailed checking and configuring of the network, please see *Chapter 12 Network Settings*.

- **OPTION 1:**

Step 1 Select **Add IP Camera** from the right-click menu in live view mode or go to **Menu> Camera> IP Camera**.

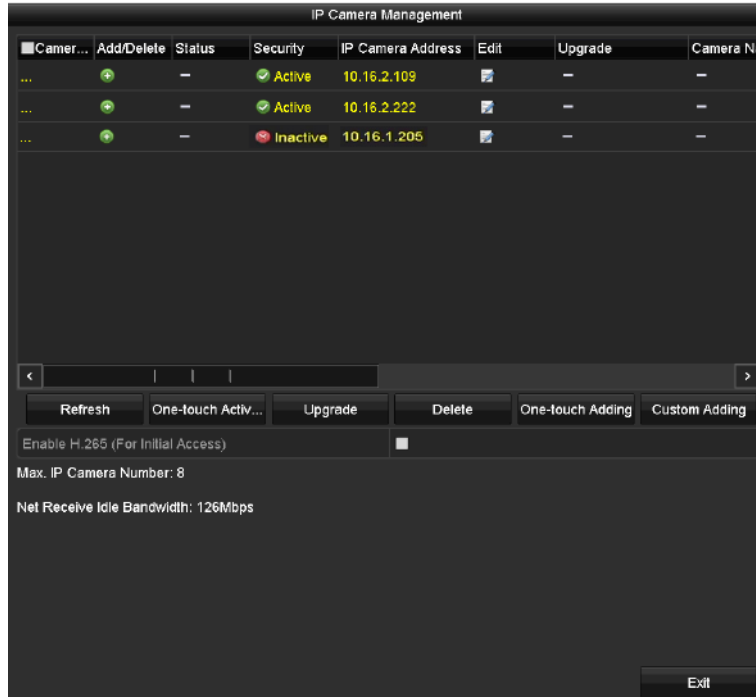



Figure 2-41 IP Camera Management Interface

Step 2 The online cameras with same network segment will be detected and displayed in the camera list.

Step 3 Select the IP camera from the list and click  to add the camera (with the same admin password of the DVR's). Or you can click **One-touch Adding** to add all cameras (with the same admin password) from the list.

 **NOTE**

Make sure the camera to add has already been activated by setting the admin password, and the admin password of the camera is the same with the DVR's.

Step 4 (Optional) Check **Enable H.265** (For Initial Access) for the connected IP camera supporting H.265. Then the IP camera will be encoded with H.265.

Step 5 (For the encoders with multiple channels only) check the checkbox of Channel Port in the pop-up window, as shown in the following figure, and click **OK** to add multiple channels.

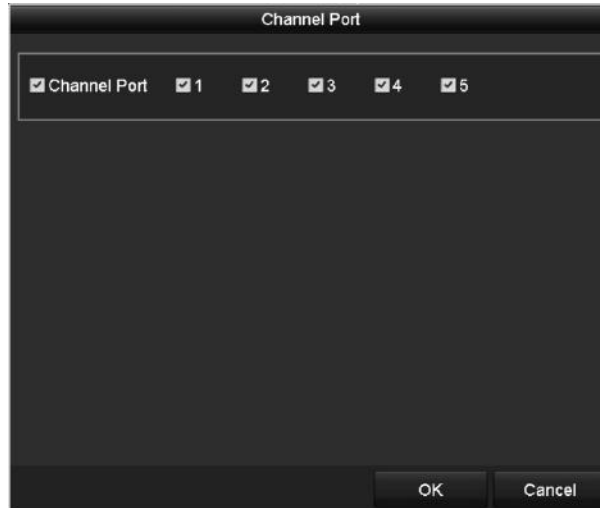

Figure 2-42 Select Multiple Channels

- **OPTION 2:**

Step 1 On the **IP Camera Management** interface, click **Custom Adding** to pop up the **Add IP Camera (Custom)** interface.

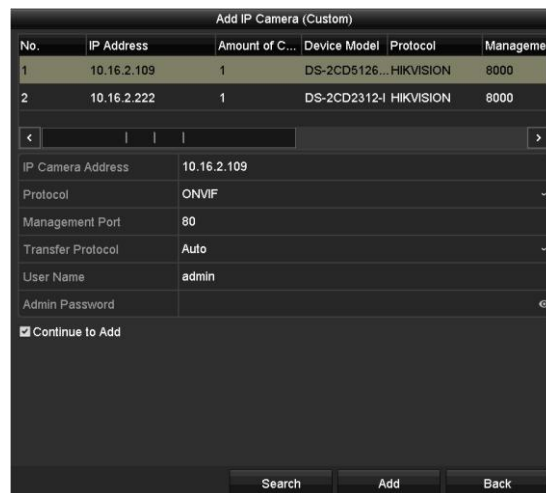

Figure 2-43 Custom Adding IP Camera Interface

Step 2 You can edit the IP address, protocol, management port, and other information of the IP camera to be added.

 **NOTE**

If the IP camera to add has not been activated, you can activate it from the IP camera list on the **IP Camera Management** interface.

Step 3 Click **Add** to add the camera.

For the successfully added IP cameras, the **Security** status shows the security level of the password of camera: strong password, weak password and risky password.

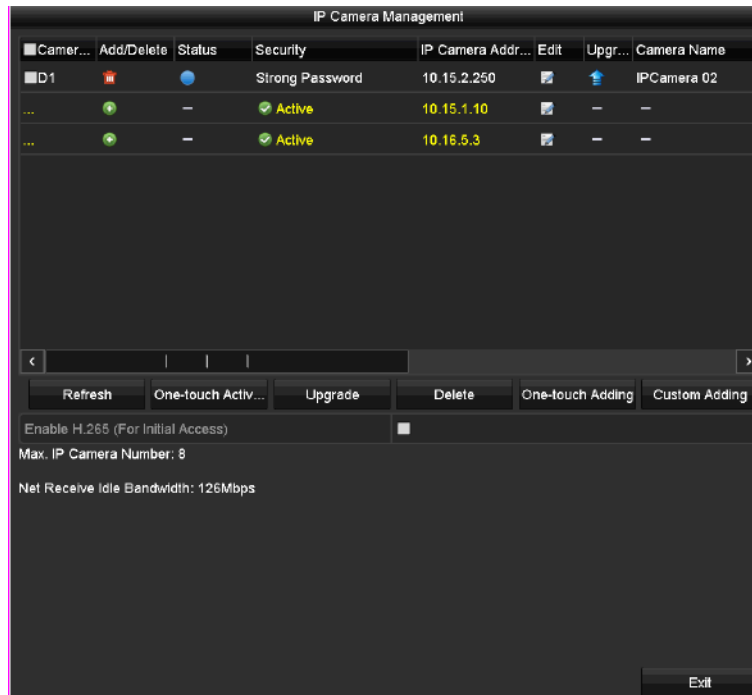









Figure 2-44 Successfully Added IP Cameras

Please refer to *Chapter 18.1* [错误!未找到引用源。](#) for the number of connectable IP cameras for different models.

Table 2-1 Explanation of the Icons

Icon	Explanation	Icon	Explanation
	Edit basic parameters of the camera		Add the detected IP camera.
	The camera is disconnected; You can click the icon to get the exception information of camera.		Delete the IP camera
	Play the live video of the connected camera.		Advanced settings of the camera.
	Upgrade the connected IP camera.	Security	Shows the security status of the camera to be active/inactive or the password strength (strong/medium/weak/risky)

Step 4 (Optional) Check **Enable H.265** (For Initial Access) for the connected IP camera supporting H.265. Then the IP camera will be encoded with H.265.

2.7.3 Editing the Connected IP Camera

Purpose

After the adding of the IP cameras, the basic information of the camera is listed on the interface, and you can configure the basic settings of the IP cameras.

Step 1 Click the  icon to edit the parameters. You can edit the IP address, protocol and other parameters.

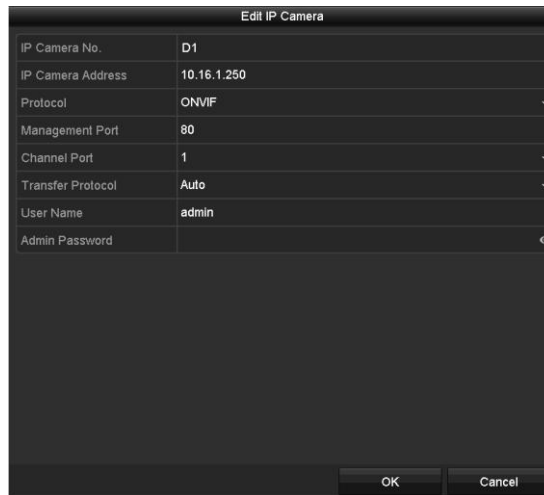



Figure 2-45 Edit IP Camera

Channel Port: If the connected device is an encoding device with multiple channels, you can choose the channel to connect by selecting the channel port No. in the drop-down list.

Step 2 Click **OK** to save the settings and exit from the editing interface.

Step 3 Drag the horizontal scroll bar to the right side and click the  icon to edit the advanced parameters.

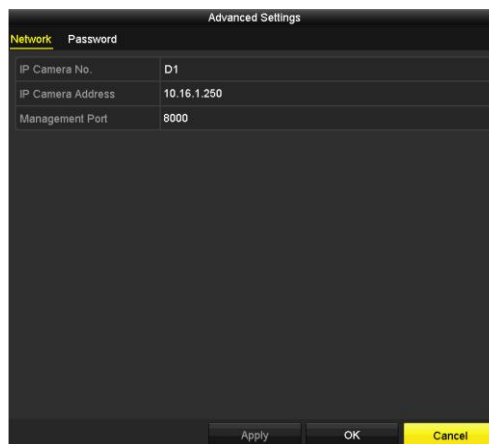

Figure 2-46 Network Configuration of the Camera

Step 4 You can edit the network information and the password of the camera.

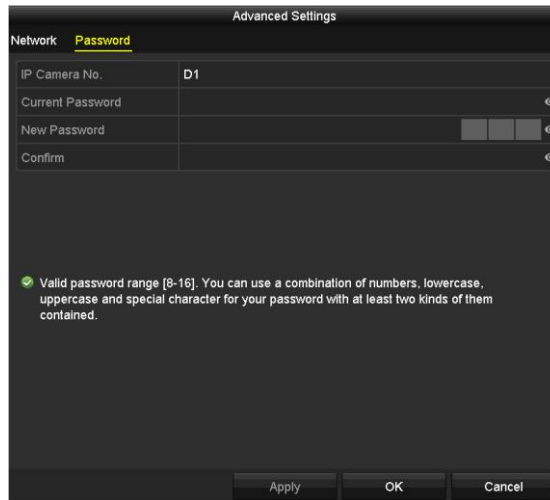

Figure 2-47 Password Configuration of the Camera

Step 5 Click **OK** to save the settings and exit the interface.

2.8 Connecting PoC Cameras

Purpose

-K/P series DVR support PoC (Power over Coaxitron) cameras connection. DVR will detect the connected PoC cameras automatically, manage the power consumption via the coaxial communication, and provide power to the cameras via coaxitron.

Before you start

Connect the PoC camera to the DVR.

Step 1 Go to **Menu > Camera > PoC Information**.

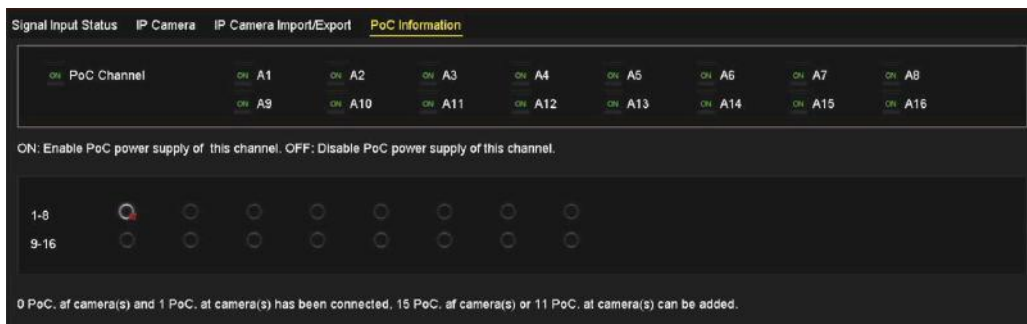

Figure 2-48 PoC Information

Step 2 Check the status of connected PoC camera. You can click the channels in **Poc Channel** to turn on/off the PoC power supply as desired.

- If the power consumption of the DVR is lower than that of AF camera, when AF or AT camera is connected, there is no video and “Insufficient Power for PoC” is overlaid on the live view image.
- If the power consumption of the DVR is higher than that of the AF camera and lower than that of the AT camera, when AF camera is connected, it is powered on normally; when AT camera is connected, it is powered on and then powered off, and there is no video and “Insufficient Power for PoC” is overlaid on the live view image.
- If the power consumption of the DVR is higher than that of the AT camera, when AF or AT camera is connected, it is powered on normally.



Figure 2-49 Note on Live View Image

Step 3 Check the connected AF or AT camera number and the connectable camera number.

 **NOTE**

- Only Hikvision PoC camera is supported.
- The maximum connectable AT/AF camera number varies with different models.

 **WARNING**

Please turn off the PoC function if the camera does not support PoC, or the camera is not produced by Hikvision. Otherwise, it may result in permanent damage to the camera or DVR.

2.9 Configuring Signal Input Channel

 **NOTE**

This chapter is only applicable to DS-7300/9000HUHI-K series DVR.

Purpose

You can configure the analog and IP signal input types and enable 5 MP long distance transmission.

Step 1 Go to **Menu > Camera > Signal Input Status**.

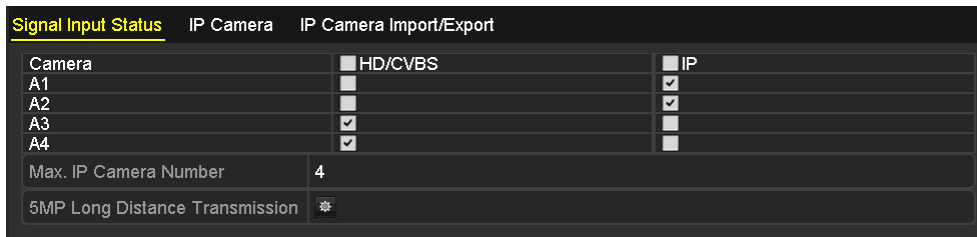

Figure 2-50 Signal Input Status

Step 2 Check the checkbox to select different signal input types: HD/CVBS and IP. If you select HD/CVBS, four types of analog signal inputs including Turbo HD, AHD, HDCVI, and CVBS can be connected randomly for the selected channel. If you select IP, IP camera can be connected for the selected channel.

Step 3 Click **Apply** to save the settings.

NOTE

You can view the max. accessible number of IP cameras in the **Max. IP Camera Number**. For DS-7300/9000HUHI-K series DVR, disabling one analog channel will add one IP channel. For DS-7300HUHI-K series DVR, the accessible IP channels are X+2 (X refers to the disabled analog channel(s) of the DVR.).For DS-9008HUHI-K8 series, the accessible IP channels are X+10 (X refers to the disabled analog channel(s) of the DVR.). For DS-9016HUHI-K8 series, the accessible IP channels are X+18 (X refers to the disabled analog channel(s) of the DVR.) and the max. IP channels are 32.

2.10 Configuring 5 MP Long Distance Transmission

NOTE

This chapter is only applicable to HUHI and HTHI series DVR.

Purpose

For HUHI and HTHI series DVR, you can configure 5 MP long distance transmission on the Signal Input Status interface.

Step 1 Go to **Menu > Camera > Signal Input Status**.



Figure 2-51 Signal Input Status (for DS-7200HUHI/HTHI Series)



Figure 2-52 Signal Input Status (for DS-7300/9000HUHI Series)

Step 2 Click  to enter the 5 MP Long Distance Transmission Settings interface.



Figure 2-53 5 MP Long Distance Transmission Settings

Step 3 Check the checkbox to enable 5 MP Long Distance Transmission of the selected channel.

Step 4 Click **Apply** to save the settings.

 **NOTE**

Please be aware, selecting this function for 5MP cameras will double the rated signal distance transmission by adjusting the resolution to 5MP@12.

Chapter 3 Live View





3.1 Introduction of Live View

Live view shows you the video image getting from each camera in real time. The DVR will automatically enter Live View mode when powered on. It is also at the very top of the menu hierarchy, thus hitting the ESC many times (depending on which menu you're on) will bring you to the Live View mode.

Live View Icons

In the live view mode, there are icons at the right top of the screen for each channel, showing the status of the record and alarm in the channel, so that you can know whether the channel is recorded, or whether there are alarms occur as soon as possible.

Table 3-1 Description of Live View Icons

Icons	Description
	Alarm (video loss, tampering, motion detection, VCA or sensor alarm)
	Record (manual record, schedule record, motion detection or alarm triggered record)
	Alarm & Record
	Event/Exception (motion detection, sensor alarm or exception information. For details, see <i>Chapter 8.7 Handling Exceptions.</i>)

3.2 Operations in Live View Mode

In live view mode, there are many functions provided. The functions are listed below.

- **Single Screen:** show only one screen on the monitor.
- **Multi-screen:** show multiple screens on the monitor simultaneously.
- **Start Auto-switch:** the screen is auto switched to the next one. And you must set the dwell time for each screen on the configuration menu before enabling the auto-switch. Menu>Configuration>Live View>Dwell Time.
- **Start Recording:** normal record and motion detection record are supported.
- **Output Mode:** select the output mode to Standard, Bright, Gentle or Vivid.

- **Playback:** play back the recorded videos for current day.
- **Aux/Main Monitor:** the DVR checks the connection of the output interfaces to define the main and auxiliary output interfaces. When the aux output is enabled, the main output cannot do any operation, and you can do some basic operation on the live view mode for the Aux output.

For DS-7300/9000HUHI-K series, there are two HDMI interfaces. HDMI1 and VGA interfaces share simultaneous output. The priority level for the main and aux output is HDMI2> VGA/HDMI1. The CVBS output only serves as the aux output or live view output. The priority relationship is shown as Table 3-2.

Table 3-2 Priorities of Outputs for DS-7300/9000HUHI-K Series

S.N	HDMI2	VGA/HDMI1	CVBS	Main output	Auxiliary output	For Live View Output Only
1	√	√	√ or ×	HDMI2	VGA/HDMI1	CVBS
2	√ or ×	×	√ or ×	HDMI2	CVBS	VGA/HDMI1
3	×	√	√ or ×	VGA/HDMI1	CVBS	HDMI2

HTHI and DS-7300HQHI-K series DVR support independent VGA and HDMI output, and simultaneous VGA/HDMI output. In the independent output mode, the priority level for the main and aux output is HDMI > VGA. The CVBS output only serves as the aux output or live view output. The priority relationship is shown as Table 3-3. In the simultaneous output mode, the VGA/HDMI output is the main output, and the CVBS output is the aux output. The priority relationship is shown as Table 3-4.

Table 3-3 Priorities of Outputs for HTHI Series in Independent Output Mode

S.N	HDMI	VGA	CVBS	Main output	Auxiliary output	For Live View Output Only
1	√	√	√ or ×	HDMI	VGA	CVBS
2	√ or ×	×	√ or ×	HDMI	CVBS	VGA
3	×	√	√ or ×	VGA	CVBS	HDMI

For other DVR with CVBS output, the VGA/HDMI output is the main output, and the CVBS output is the aux output. The priority relationship is shown as Table 3-4.

Table 3-4 Priorities of Outputs

S.N	HDMI	VGA	CVBS	Main output	Auxiliary output
1	√ or ×	√ or ×	√ or ×	VGA/HDMI	CVBS



√ means the interface is in use, × means the interface is out of use or the connection is invalid. And the HDMI, VGA and CVBS can be used at the same time.

3.2.1 Using the Mouse in Live View

You can refer to Table 3-4 for the description of mouse operation in live view mode.

Table 3-5 Mouse Operation in Live View

Name	Description
Menu	Enter the main menu of the system by right clicking the mouse.
Single Screen	Switch to the single full screen by choosing channel number from the drop-down list.
Multi-Screen	Adjust the screen layout by selecting from the drop-down list.
Previous Screen	Switch to the previous screen.
Next Screen	Switch to the next screen.
Start/Stop Auto-Switch	<p>Enable/disable the auto-switch of the screens.</p> <p> NOTE The <i>dwel time</i> of the live view configuration must be set before using Start Auto-Switch.</p>
Start Recording	Start recording of all channels, Continuous Record and Motion Detection Record are selectable from the drop-down list.
Add IP Camera	A shortcut to enter the IP camera management interface.(For HDVR series only)
Playback	Enter the playback interface and start playing back the video of the selected channel immediately.
PTZ Control	A shortcut to enter the PTZ control interface of the selected camera.

Output Mode	Output Mode is configurable with Standard, Bright, Gentle and Vivid options.
Aux Monitor	<p>Switch to the auxiliary output mode and the operation for the main output is disabled.</p> <p> NOTE</p> <p>If you enter Aux monitor mode and the Aux monitor is not connected, the mouse operation is disabled. You need to switch back to the Main output with F1 on front panel or VOIP/MON on IR remote control and then press Enter.</p>

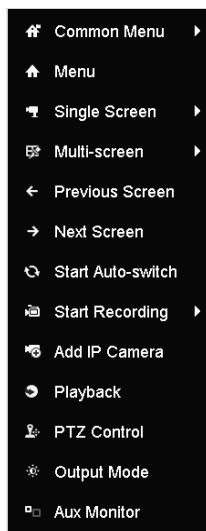

Figure 3-1 Right-click Menu

3.2.2 Switching Main/ Aux Output

 **NOTE**

- Refer to *Chapter 3.2 Operations in Live View Mode* for the main and aux output relationship.
- The CVBS output only serves as the aux output or live view output.

Step 1 Use the mouse wheel to double-click on the HDMI1/VGA, or HDMI2, or HDMI/VGA output screen, and the following message box pops up.

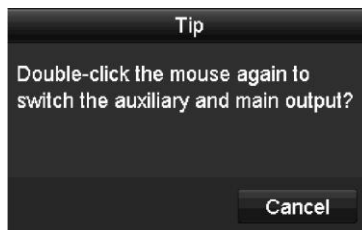

Figure 3-2 Switch Main and Aux Output

Step 2 Use the mouse wheel to double-click on the screen again to switch to the aux output, or click **Cancel** to cancel the operation.

Step 3 Select the **Menu Output Mode** to others from the right-click menu on the monitor.

Step 4 On the pop-up message box, click **Yes** to reboot the device to enable the selected menu output as the main output.

 **NOTE**

You can select the **Menu Output Mode** under **Menu > Configuration > General > More Settings** to **Auto, HDMI1/VGA** and **HDMI2** (for DS-7300/9000HUHI-K) or **Auto** and **HDMI/VGA** (for other models) and then reboot the device to switch the main output.

3.2.3 Quick Setting Toolbar in Live View Mode











On the screen of each channel, there is a quick setting toolbar which shows when you click the screen.



Figure 3-3 Quick Setting Toolbar

You can refer to Table 3-5 for the description of Quick Setting Toolbar icons.

Table 3-6 Description of Quick Setting Toolbar Icons

Icons	Description	Icons	Description	Icons	Description
	Enable/Disable Manual Record		Instant Playback		Mute/Audio on
	PTZ Control		Digital Zoom		Image Settings
	Close Live View		Face Detection		Information
	Show/Hide VCA Information		Capture		

 **NOTE**

- Showing/Hiding VCA information is only applicable to HUHI and HTHI series DVR.
- Picture capture is only applicable to DS-7300/9000HUHI-K series DVR.



Instant Playback only shows the record in last five minutes. If no record is found, it means there is no record during the last five minutes.



Digital Zoom is for zooming in the live image. You can zoom in the image to different proportions (1 to16X) by moving the sliding bar. You can also scroll the mouse wheel to control the zoom in/out.



Figure 3-4 Digital Zoom



Image Settings icon can be selected to enter the Image Settings menu. You can drag the mouse or click  to adjust the image parameters, including brightness, contrast, and saturation. Refer to the *Chapter 15.3 Configuring Video Parameters* for details.

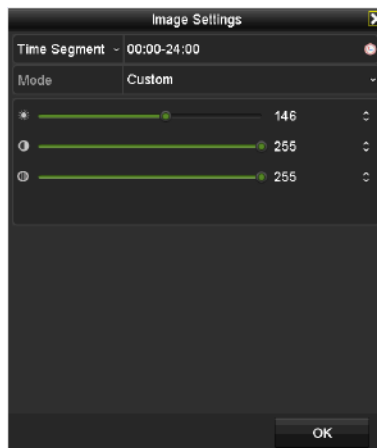

Figure 3-5 Image Settings



Face Detection can be enabled if you click the icon. The dialog pops up as shown in Figure 3-6. Click **Yes** and the full-screen live view of the channel is enabled. You can click  to exit from the full-screen mode.



Figure 3-6 Enable Face Detection



NOTE

You can configure face detection only when it is supported by the connected camera.

 Move the mouse onto the Information icon to show the real-time stream information, including the frame rate, bit rate, resolution and stream type.

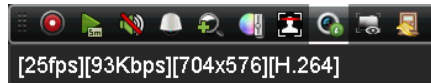

Figure 3-7 Information

 **NOTE**

When H.264 IP camera is connected, the stream type is displayed as H.264. When IP camera supporting H.264+ is connected, the stream type is displayed as H.264+. When IP camera supporting H.265 is connected, the stream type is displayed as H.265. When IP camera supporting H.265+ is connected, the stream type is displayed as H.265+.



For analog cameras supporting VCA, click the icon to show the VCA information. Then the configured line or quadrilateral in the VCA configuration and target frame(s) will be shown on the live view. Click the icon again to hide the VCA information.

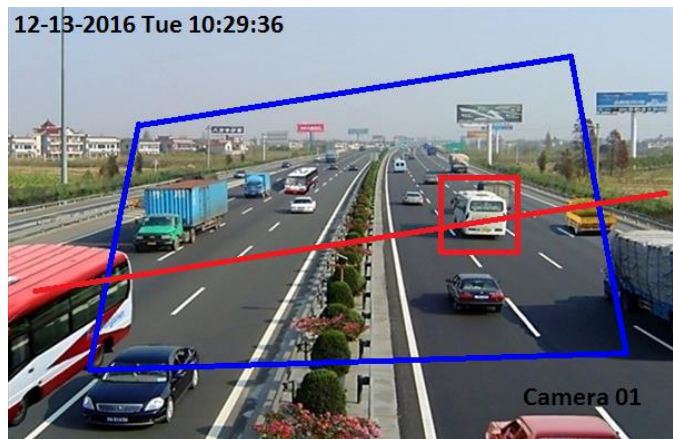

Figure 3-8 Enable VCA Information Overlay

 **NOTE**

- In the live view, only the analog cameras support VCA information overlay.
- Enable VCA function first before showing the VCA information. Refer to *Chapter 10 VCA Alarm* for the detailed operation.
- The VCA information is hidden by default. If the connected analog camera does not support VCA, the icon displays grey and cannot be operated.
- For the analog cameras, the VCA information includes line crossing detection and intrusion detection.
- The DVR only supports VCA information overlay of one channel. If you enable the function of one channel, the other channels will disable the function automatically.
- Both single window and multi-window display modes support VCA information overlay.
- Only the main output supports VCA information overlay. When switching to the aux output, the VCA information overlay of main output is disabled.

- For the analog cameras, if the camera number does not exceed the limit for line crossing detection and intrusion detection, the VCA information overlay can be enabled for all the analog cameras enabled line crossing detection and intrusion detection. If the camera number exceeds the limit for line crossing detection, intrusion detection and sudden scene change detection, only the cameras enabled line crossing detection and intrusion detection support VCA information overlay. Disabling line crossing detection and intrusion detection remotely will not affect the VCA information overlay in the local live view.

3.3 Channel-Zero Encoding

Purpose

Sometimes you need to get a remote view of many channels in real time from web browser or CMS (Client Management System) software, in order to decrease the bandwidth requirement without affecting the image quality, channel-zero encoding is supported as an option for you.

Step 1 Go to **Menu > Configuration > Live View > Channel-Zero Encoding**.

Enable Channel-Zero Enc...	<input checked="" type="checkbox"/>
Frame Rate	12fps
Max. Bitrate Mode	General
Max. Bitrate(Kbps)	1024

Figure 3-9 Live View- Channel-Zero Encoding

Step 2 Check the checkbox after **Enable Channel-Zero Encoding**.

Step 3 Configure the Frame Rate, Max. Bitrate Mode and Max. Bitrate.

Step 4 Click **Apply** to activate the settings.

Step 5 After you set the Channel-Zero encoding, you can get a view in the remote client or web browser of 16 channels in one screen.

3.4 Adjusting Live View Settings

Purpose

Live View settings can be customized according to different needs. You can configure the output interface, dwell time for screen to be shown, mute or turning on the audio, the screen number for each channel, etc.

Step 1 Go to **Menu > Configuration > Live View > General**.



Figure 3-10 Live View-General

The settings available in this menu include:

- **Video Output Interface:** Selects the output to configure the settings.

For DS-7300/9000HUHI-K series DVR, you can select **VGA/HDMI1**, **HDMI2**, **Main CVBS** for video output interface.

For HTHI and DS-7300HQHI-K series DVR, if you have enabled VGA/HDMI simultaneous output under **Menu > Configuration > General > More Settings**, you can select **VGA/HDMI** and **Main CVBS** for video output interface. If you have enabled independent VGA and HDMI output, you can select **VGA**, **HDMI**, and **Main CVBS** for video output interface.

For other models, you can select **Main CVBS** and **HDMI/VGA** for video output interface.

- **Live View Mode:** Selects the display mode to be used for Live View.

 **NOTE**

- For HUHI and HTHI series DVR, if you set the video output resolution as 1024*768 in **Menu > Configuration > General**, when you set more than 16 windows, the following message box will pop up as below. If you set the video output resolution as 1280*720 or 1280*1024 in **Menu > Configuration > General**, when you set more than 25 windows, the following message box will pop up as below.

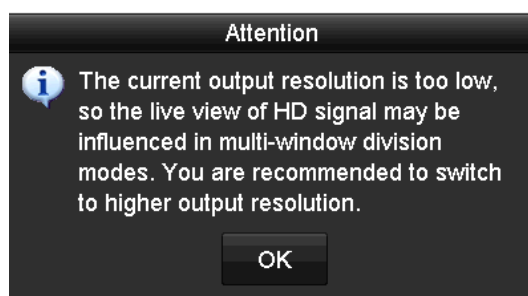

Figure 3-11 Note for Live View Mode

- If you have set the video output resolution larger than 1280*1024, and then switch to low resolution, the former live view mode will not be changed.
- **Dwell Time:** The time in seconds to *dwell* between switching of channels when enabling auto-switch in Live View.
- **Enable Audio Output:** Enables/disables audio output for the selected camera in the live view mode.





- **Volume:** Adjusts the volume of the audio output.
- **Event Output:** Designates the output to show event video. If available, you can select a different video output interface from the Video Output Interface when an event occurs.
- **Full Screen Monitoring Dwell Time:** Sets the time in seconds to show alarm event screen.

Step 2 Set the camera order.

- 1) Click **View** tab and select **Video Output Interface** from the drop-down list.



Figure 3-12 Live View-Camera Order

- 2) Select a window, and then double-click a camera name in the camera list you would like to display. Setting an 'X' means the window will not display any camera.
- 3) You can also click  to start live view of all channels in order and click  to stop live view of all channels. Click  or  to go to the previous or next page.
- 4) Click **Apply**.

 **NOTE**

For DS-7300/9000HUHI-K series DVR, if the sum of the analog and IP channels exceeds 25, up to 32-window division mode is supported for the VGA/HDMI1 output.

3.5 Manual Video Quality Diagnostics

Purpose

The video quality of the analog channels can be diagnosed manually and you can view the diagnostic results from a list.

Step 1 Go to **Menu > Manual > Manual Video Quality Diagnostics**.



Figure 3-13 Video Quality Diagnostics

Step 2 Check the checkboxes to select the channels for diagnostics.

Step 3 Click **Diagnose**, and the results will be displayed on a list. You can view the video status and diagnostics time of the selected channels.

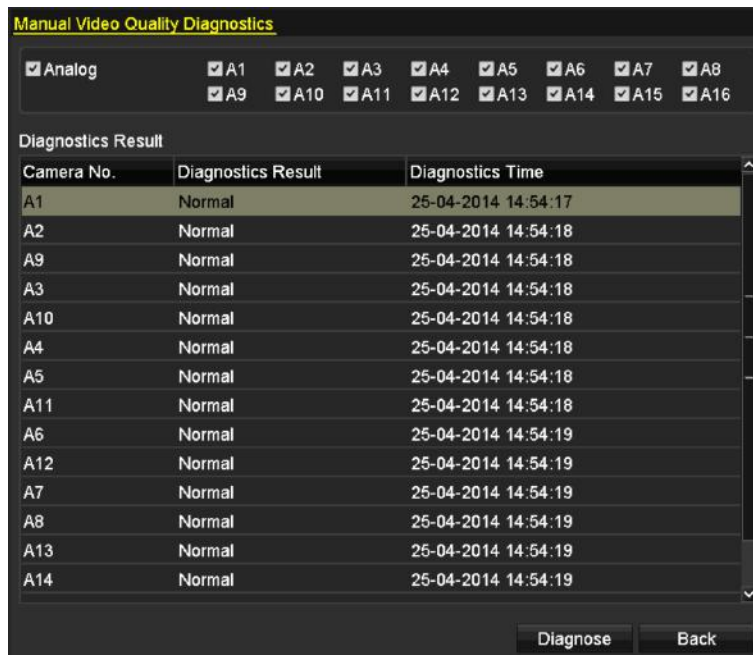

Figure 3-14 Diagnostics Result

 **NOTE**

- Connect the camera to the device for the video quality diagnostics.
- Three exception types can be diagnosed: Blurred Image, Abnormal Brightness and Color Cast.

Chapter 4 PTZ Controls

4.1 Configuring PTZ Settings

Purpose

Follow the procedure to set the parameters for PTZ. The configuring of the PTZ parameters should be done before you control the PTZ camera.

Step 1 Go to **Menu >Camera> PTZ**.

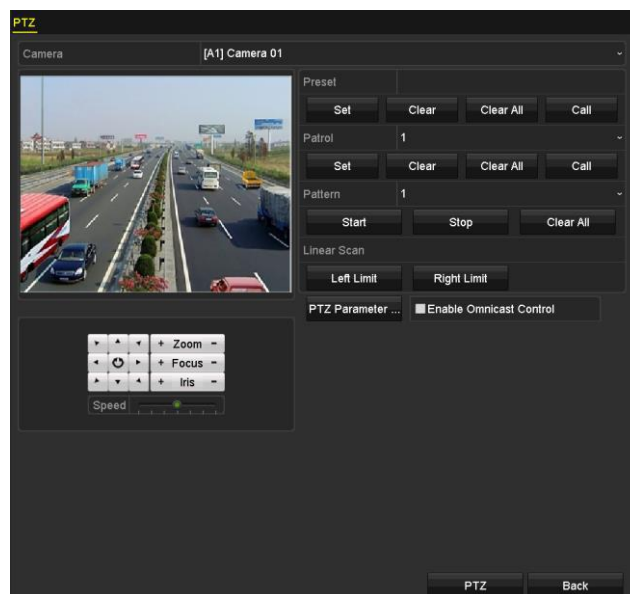

Figure 4-1 PTZ Settings

Step 2 Select the camera for PTZ setting in **Camera**.

Step 3 Click **PTZ Parameters** to set the PTZ parameters.



Figure 4-2 PTZ-General

Step 4 Select the parameters of the PTZ camera from the drop-down list.



NOTE

- All the parameters should be exactly the same as the PTZ camera parameters.
- For the Coaxitron camera/dome connected, you can select the PTZ protocol to UTC (Coaxitron). Make sure the protocol selected here is supported by the connected camera/dome.
- When the Coaxitron protocol is selected, all the other parameters like the baud rate, data bit, stop bit, parity and flow control are not configurable.
- When Hikvision CVBS camera is connected, you can control PTZ via Coaxitron.

Step 5 (Optional) Click **Copy** to copy the settings to the other channels. Select the channels you want to copy to and click **OK** to return to the **PTZ Parameters Settings** interface.

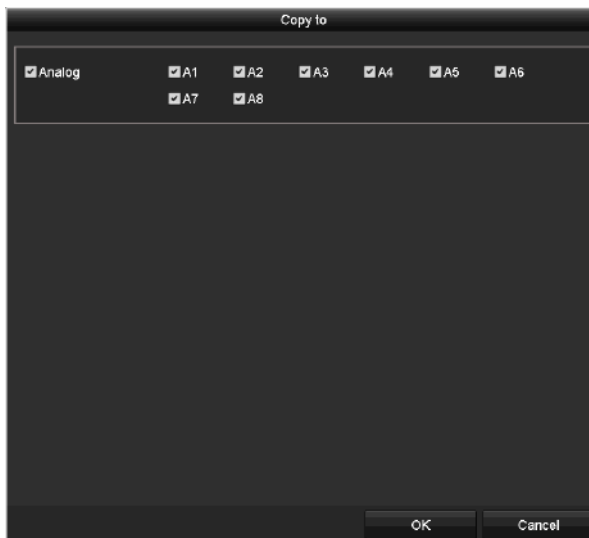

Figure 4-3 Copy to Other Channels

Step 6 Click **OK** to save the settings.

Step 7 (Optional) Check **Enable Omnicast Control** to enable the PTZ control of the selected camera via Omnicast VMS of Genetec.

4.2 Setting PTZ Presets, Patrols and Patterns

Before you start

Please make sure that the presets, patrols and patterns should be supported by PTZ protocols.

4.2.1 Customizing Presets

Purpose

Follow the steps to set the Preset location which you want the PTZ camera to point to when an event takes place.

Step 1 Go to **Menu>Camera>PTZ**.

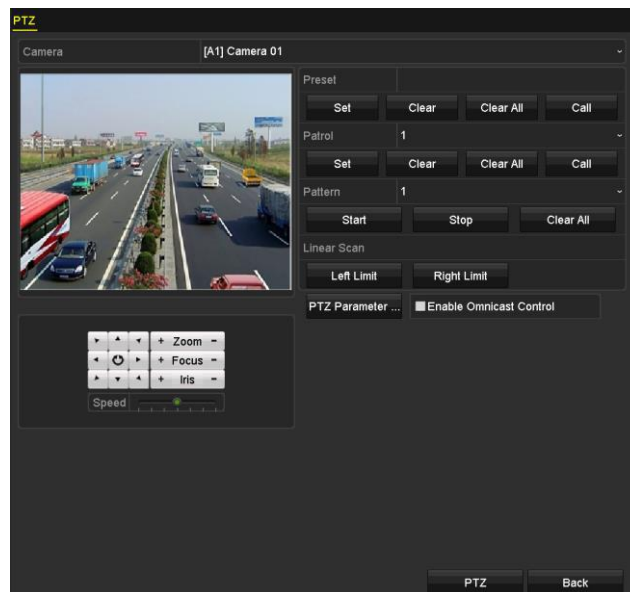

Figure 4-4 PTZ Settings

Step 2 Use the directional button to wheel the camera to the location where you want to set preset; and the zoom and focus operations can be recorded in the preset as well.

Step 3 Enter the preset No. (1~255) in the preset text field, and click **Set** to link the location to the preset.

Repeat the steps from 2 to 3 to save more presets.

You can click **Clear** to clear the location information of the preset, or click **Clear All** to clear the location information of all the presets.

4.2.2 Calling Presets

Purpose

This feature enables the camera to point to a specified position such as a window when an event takes place.

Step 1 Click **PTZ** in the lower-right corner of the PTZ setting interface;

Or press **PTZ** on the front panel or click the PTZ Control icon  in the quick setting bar, or select the PTZ option in the right-click menu to show the PTZ control panel.

Step 2 Choose **Camera** in the drop-down list.

Step 3 Click **General** to show the general settings of the PTZ control.

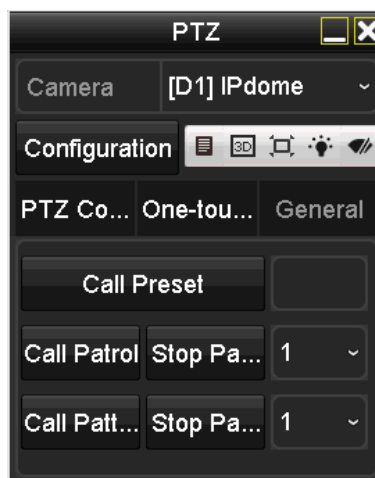

Figure 4-5 PTZ Panel-General

Step 4 Click to enter the preset No. in the corresponding text field.

Step 5 Click **Call Preset** to call it.

NOTE

When the Coaxitron camera/dome connected and the PTZ protocol is selected to UTC (Coaxitron), you can call the preset 95 to enter the menu of the connected Coaxitron camera/dome. Use the directional buttons on the PTZ control panel to operate the menu.

4.2.3 Customizing Patrols

Purpose

Patrols can be set to move the PTZ to different key points and have it stay there for a set duration before moving on to the next key point. The key points are corresponding to the presets. The presets can be set following the steps above in *Customizing Presets*.

Step 1 Go to **Menu>Camera>PTZ**.

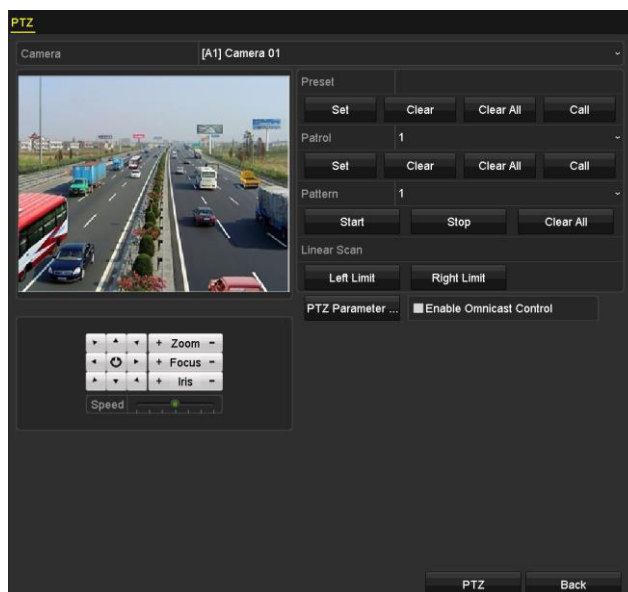

Figure 4-6 PTZ Settings

Step 2 Select patrol No. in the drop-down list of patrol.

Step 3 Click **Set** to add key points for the patrol.

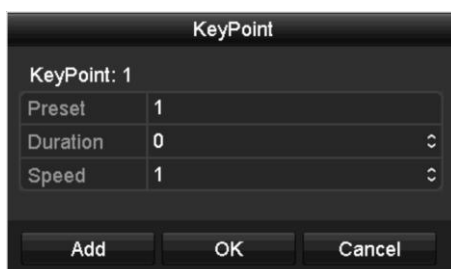

Figure 4-7 Key point Configuration

Step 4 Configure key point parameters, such as the key point No., duration of staying for one key point and speed of patrol. The key point is corresponding to the preset. The **Key Point No.** determines the order at which the PTZ will follow while cycling through the patrol. The **Duration** refers to the time span to stay at the corresponding key point. The **Speed** defines the speed at which the PTZ will move from one key point to the next.

Step 5 Click **Add** to add the next key point to the patrol, or you can click **OK** to save the key point to the patrol.

You can delete all the key points by clicking **Clear** for the selected patrol, or click **Clear All** to delete all the key points for all patrols.

4.2.4 Calling Patrols

Purpose

Calling a patrol makes the PTZ to move according the predefined patrol path.

Step 1 Click **PTZ** in the lower-right corner of the **PTZ Settings** interface;

Or press the PTZ button on the front panel or click the PTZ Control icon  in the quick setting bar, or select the PTZ option in the right-click menu to show the PTZ control panel.

Step 2 Click **General** to show the general settings of the PTZ control.



Figure 4-8 PTZ Panel - General

Step 3 Select a patrol in the drop-down list and click **Call Patrol** to call it.

Step 4 You can click **Stop Patrol** to stop calling it.

4.2.5 Customizing Patterns

Purpose

Patterns can be set by recording the movement of the PTZ. You can call the pattern to make the PTZ movement according to the predefined path.

Step 1 Go to **Menu>Camera>PTZ**.

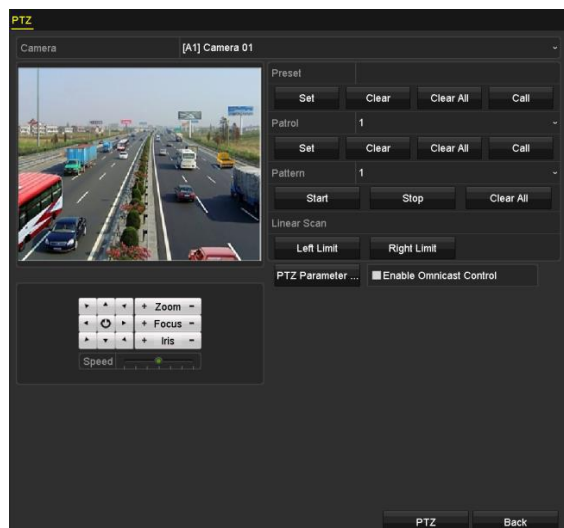

Figure 4-9 PTZ Settings

Step 2 Choose pattern number in the drop-down list.

Step 3 Click **Start** and click corresponding buttons in the control panel to move the PTZ camera, and click **Stop** to stop it.

The movement of the PTZ is recorded as the pattern.

4.2.6 Calling Patterns

Purpose

Follow the procedure to move the PTZ camera according to the predefined patterns.

Step 1 Click **PTZ** in the lower-right corner of the **PTZ Settings** interface;

Or press the PTZ button on the front panel or click the PTZ Control icon  in the quick setting bar, or select the PTZ option in the right-click menu to show the PTZ control panel.

Step 2 Click **General** to show the general settings of the PTZ control.

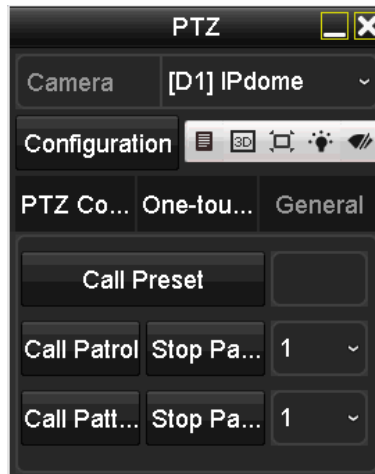

Figure 4-10 PTZ Panel - General

Step 3 Click **Call Pattern** to call it.

Step 4 Click **Stop Pattern** to stop calling it.

4.2.7 Customizing Linear Scan Limit

Purpose

The Linear Scan can be enabled to trigger the scan in the horizontal direction in the predefined range.



NOTE

This function is supported by some certain models.

Step 1 Go to **Menu>Camera>PTZ**.

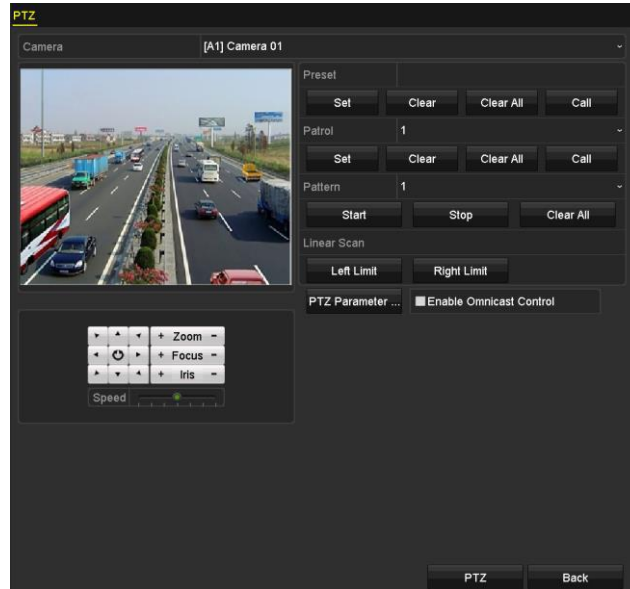

Figure 4-11 PTZ Settings

Step 2 Use the directional button to wheel the camera to the location where you want to set the limit, and click **Left Limit** or **Right Limit** to link the location to the corresponding limit.

 **NOTE**

The speed dome starts linear scan from the left limit to the right limit, and you must set the left limit on the left side of the right limit, as well the angle from the left limit to the right limit should be no more than 180°.

4.2.8 Calling Linear Scan

Purpose

Follow the procedure to call the linear scan in the predefined scan range.

Step 1 Click **PTZ** in the lower-right corner of the **PTZ Settings** interface;

Or press the PTZ button on the front panel or click the PTZ Control icon  in the quick setting bar to enter the PTZ setting menu in live view mode.

Step 2 Click **One-touch** to show the one-touch function of the PTZ control.



Figure 4-12 PTZ Panel - One-touch

Step 3 Click **Linear Scan** to start the linear scan and click **Linear Scan** again to stop it.

You can click **Restore** to clear the defined left limit and right limit data and the dome needs to reboot to make settings take effect.

4.2.9 One-Touch Park

Purpose

For some certain model of the speed dome, it can be configured to start a predefined park action (scan, preset, patrol and etc.) automatically after a period of inactivity (park time).

Step 1 Click **PTZ** in the lower-right corner of the **PTZ Settings** interface;

Or press the PTZ button on the front panel or click the PTZ Control icon  in the quick setting bar to enter the PTZ setting menu in live view mode.

Step 2 Click **One-touch** to show the one-touch function of the PTZ control.

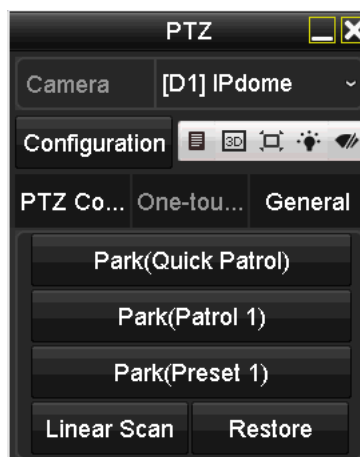

Figure 4-13 PTZ Panel - One-touch

Step 3 There are 3 one-touch park types selectable. Click the corresponding button to activate the park action.

Park (Quick Patrol): The dome starts patrol from the predefined preset 1 to preset 32 in order after the park time. The undefined preset will be skipped.

Park (Patrol 1): The dome starts moving according to the predefined patrol 1 path after the park time.

Park (Preset 1): The dome moves to the predefined preset 1 location after the park time.

 **NOTE**

The park time can only be set through the speed dome configuration interface. The default value is 5s.

Step 4 Click the button again to inactivate it.

4.3 PTZ Control Panel

To enter the PTZ control panel, there are two ways supported.

OPTION 1:

In the **PTZ Settings** interface, click **PTZ** on the lower-right corner which is next to **Back**.

OPTION 2:

In the Live View mode, you can press the PTZ Control button on the front panel or on the remote control, or choose the PTZ Control icon  in the quick setting bar, or select the PTZ Control option in the right-click menu.

Click **Configuration** on the control panel, and you can enter the **PTZ Settings** interface.

 **NOTE**

In PTZ control mode, the PTZ panel will be displayed when a mouse is connected with the device. If no mouse is connected, the **PTZ** icon appears in the lower-left corner of the window, indicating that this camera is in PTZ control mode.

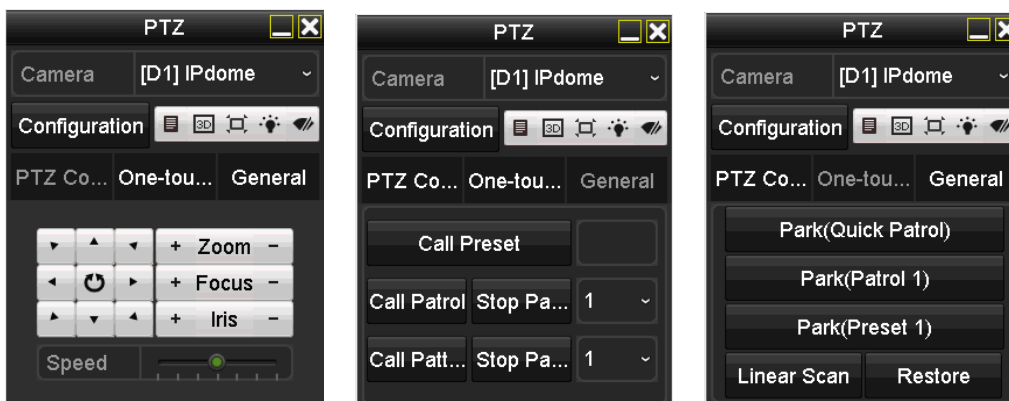









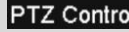







Figure 4-14 PTZ Control Panel

You can refer to Table 4-1 for the description of the PTZ panel icons.

Table 4-1 Description of the PTZ panel icons

Icon	Description	Icon	Description	Icon	Description
	Direction button and the auto-cycle button		Zoom+, Focus+, Iris+		Zoom-, Focus-, Iris-
	The speed of the PTZ movement		Light on/off		Wiper on/off
	3D-Zoom		Image Centralization		Menu
	Switch to the PTZ control interface		Switch to the one-touch control interface		Switch to the general settings interface
	Exit		Minimize windows		

 **NOTE**

When Hikvision CVBS camera is connected, you can click  to call the OSD of the camera.

Chapter 5 Recording and Capture Settings



NOTE

The picture capture is supported by the DS-7300/9000HUHI-K series DVR only.

5.1 Configuring Encoding Parameters

Before you start

Step 1 Make sure that the HDD has already been installed. If not, please install a HDD and initialize it. (Menu>HDD>General)

Label	Capacity	Status	Property	Type	Free Space	Gr...	Edit	Delete
1	2794.52GB	Normal	R/W	Local	2613.00GB	1	-	-

Figure 5-1 HDD- General

Step 2 Click **Advanced** to check the storage mode of the HDD. (Menu>HDD>Advanced>Storage Mode)

- 1) If the HDD mode is *Quota*, please set the maximum record capacity. For detailed information, see *Chapter 14.4 Configuring Quota Mode*.
- 2) If the HDD mode is *Group*, you should set the HDD group. For detailed information, see *Chapter 5.9 Configuring HDD Group*.

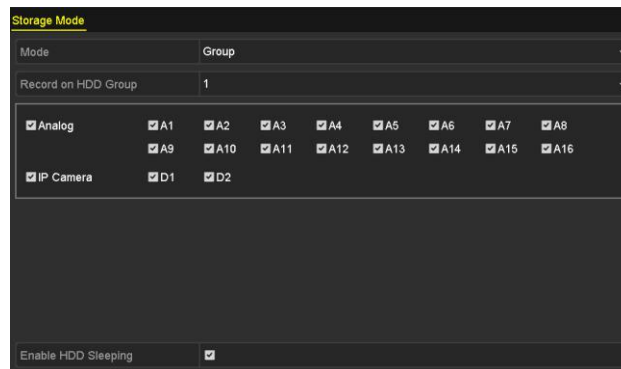

Figure 5-2 HDD- Advanced

Steps

Step 1 Go to **Menu>Record>Parameters**.

Camera	[A1] Camera 01	
Camera Resolution	NO VIDEO	
Encoding Parameters	Main Stream(Continuous)	Main Stream(Event)
Stream Type	Video & Audio	Video & Audio
Resolution	1920*1080(1080P)	1920*1080(1080P)
Bitrate Type	Variable	Variable
Video Quality	Medium	Medium
Frame Rate	Full Frame	Full Frame
Max. Bitrate Mode	General	General
Max. Bitrate(Kbps)	2048	2048
Max. Bitrate Range Recommend...	1920~3200(Kbps)	1920~3200(Kbps)
Max. Average Bitrate(Kbps)	1440	1440
Video Encoding	H.265	H.265
Enable H.265+	<input checked="" type="checkbox"/>	
More Settings...		
Powered by H.265 Pro		

Figure 5-3 Record Parameters

Step 2 Set the parameters for recording.

- 1) Select **Record** to configure.
- 2) Select a camera from the camera drop-down list.
- 3) View **Camera Resolution**.

 **NOTE**

When Turbo HD, AHD, or HDCVI input is connected, you can view the information including the input signal type, resolution and frame rate (e.g., 1080P30). When CVBS input is connected, you can view the information such as NTSC or PAL.

- 4) Configure the following parameters for **Main Stream (Continuous)** and **Main Stream (Event)**.

Stream Type: Set the stream type to be Video or Video & Audio.

Resolution: Set recording resolution.

 **NOTE**

- HTHI, 7108HUHI, 7208/7216HUHI, 7300HUHI, and 9000HUHI series DVR support up to 8 MP resolution of all the channels.
- HQHI series DVR support up to 4 MP lite resolution of all the channels.
- The 3 MP signal input is available for channel 1 of HQHI series DVR with 4 video inputs, for channel 1/2 of HQHI series DVR with 8 video inputs, and for channel 1/2/3/4 of HQHI series DVR with 16 video inputs.
- The analog signal inputs (Turbo HD, AHD, HDCVI, CVBS) and IP signal input can be recognized and connected automatically.
- If the configured encoding resolution conflicts with the resolution of the front-end camera, the encoding parameters will adjust automatically to meet the front-end camera. E.g., if the resolution of the front-end camera is 720p, then the encoding resolution of the main stream will adjust to 720p automatically.

- The resolution of 960 × 1080 (1080P Lite) is available when the 1080P Lite is enabled in the Record>Advanced Settings interface (refer to *Chapter 5.12 Configuring 1080P Lite*).
- Please refer to the *Appendix-Specifications* for the supported resolutions of different models.

Bitrate Type: Set the bitrate type to be Variable or Constant.

Video Quality: Set the video quality of recording, with 6 levels configurable.

 **NOTE**

The Stream Type, Resolution, Bitrate Type and Video Quality are not configurable for the Main Stream (Event) of the IP Camera.

Frame Rate: Set the frame rate of recording.

 **NOTE**

- For HTHI series DVR, when 8 MP signal input is connected, the frame rate of the main stream cannot exceed 12 fps.
- For HQHI series DVR, when 4 MP lite signal input is connected, the frame rate of the main stream cannot exceed 15 fps.
- For HUHI series DVR, when 8 MP signal input is connected, the frame rate of the main stream cannot exceed 8 fps. When 5 MP signal input is connected, the frame rate of the main stream cannot exceed 12 fps.
- The minimum frame rate for main stream is 1 fps.
- If you set different frame rates for the continuous and event recording, when you click **Apply** to save the settings, the note pops up as below.

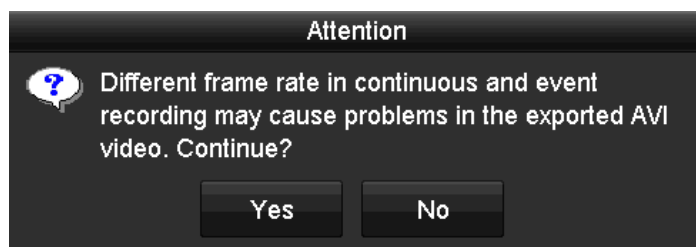

Figure 5-4 Note for Different Frame Rates

Max. Bitrate Mode: Set the mode to General or Custom.

Max Bitrate (Kbps): Select or customize the maximum bit rate for recording.

Max. Bitrate Range Recommended: A recommended max. bit rate range is provided for reference.

Max. Average Bitrate (Kbps): Set the max. average bit rate which refers to the average amount of data transferred per unit of time.

Video Encoding:

You can configure H.264 or H.265 for the main stream (continuous) of IP and analog cameras.

 **NOTE**

- When the connected IP camera does not support H.265, only H.264 can be selected for the main stream (continuous).
- When **Video Encoding** is set to H.265 and **Bitrate Type** is set to variable, or when **Video Encoding** is set to be H.265+, the prompt **Powered by H.265 Pro** reminds that a new video encoding mode with a higher encoding rate has been enabled, as shown in figure 5-5.

Camera	[A1] Camera 01	
Camera Resolution	NO VIDEO	
Encoding Parameters	Main Stream(Continuous)	Main Stream(Event)
Stream Type	Video & Audio	Video & Audio
Resolution	1920*1080(1080P)	1920*1080(1080P)
Bitrate Type	Variable	Variable
Video Quality	Medium	Medium
Frame Rate	Full Frame	Full Frame
Max. Bitrate Mode	General	General
Max. Bitrate(Kbps)	2048	2048
Max. Bitrate Range Recommend...	1920~3200(Kbps)	1920~3200(Kbps)
Max. Average Bitrate(Kbps)	1440	1440
Video Encoding	H.265	H.265
Enable H.265+	<input checked="" type="checkbox"/>	
More Settings...		
Powered by H.265 Pro		

Figure 5-5 Record Parameters

Step 3 Check **Enable H.264+** or **Enable H.265+** to enable this function. Enabling it helps to ensure the high video quality with a lowered bitrate.

 **NOTE**

- For 7100HUHI, 7208/7216HUHI, 7300HUHI, and 9000HUHI series DVR, if the video encoding is H.264 or H.265, when 8 MP signal input is connected, H.264+ or H.265+ is disabled. If the video encoding is H.264+ or H.265+, when 8 MP signal input is connected, the video encoding will change to H.264 or H.265 automatically, and H.264+ or H.265+ is disabled. Event if you check **Enable H.264+** or **Enable H.265+** when 8 MP signal input is connected, the device will still encode with H.264 or H.265.
- After enabling H.264+ or H.265+, the **Bitrate Type**, **Video Quality**, **Max. Bitrate Mode**, **Max. Bitrate(Kbps)** and **Max. Bitrate Range Recommend** are not configurable.
- If H.265+ is enabled, line crossing detection and region entrance detection are not supported.
- For the connected IP camera, the H.264+ or H.265+ should be supported by the camera and added to the DVR with the HIKVISION protocol.
- You should reboot the device to activate the new settings after enabling the H.264+ or H.265+.

Step 4 Click **More Settings** to configure more parameters.



Figure 5-6 More Settings of Record Parameters

Pre-record: The time you set to record before the scheduled time or event. For example, when an alarm triggered the recording at 10:00, if you set the pre-record time as 5 seconds, the camera records it at 9:59:55.

Post-record: The time you set to record after the event or the scheduled time. For example, when an alarm triggered the recording ends at 11:00, if you set the post-record time as 5 seconds, it records till 11:00:05.

Expired Time: The time for keeping the record files in the HDDs, once exceeded, the files will be deleted. The files will be saved permanently if the value is set as 0. The actual keeping time for the files should be determined by the capacity of the HDDs.

Redundant Record: Enabling redundant record means you save the record in the redundant HDD. See *Chapter 5.8 Configuring Redundant Recording*.

Record Audio: Enable this feature to record the sound and disable it to record the video without sound.

Video Stream: Main stream, Sub-stream and Dual-stream are selectable for recording. When you select sub-stream, you can record for a longer time with the same storage space.

 **NOTE**

- The **Redundant Record** option is only available when the HDD mode is *Group*.
- Redundant HDD is required for the redundant record function. For detailed information, see *Chapter 14.3.2 Setting HDD Property*.
- For network cameras, the parameters of Main Stream (Event) are not editable.

Step 5 Click **Apply** to save the settings.

Step 6 Optionally, you can click **Copy** to copy the settings to other analog channels if needed.

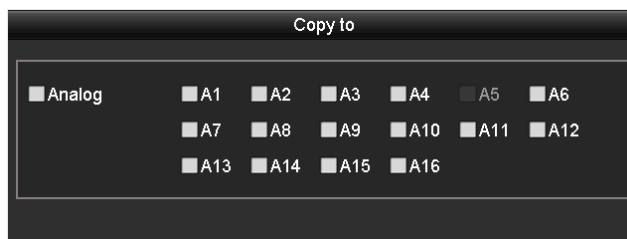

Figure 5-7 Copy Camera Settings

Step 7 Set encoding parameters for sub-stream.

1) Select **Sub-Stream**.

Camera	[A1] Camera 01
Stream Type	Video
Resolution (maximum value is W...	352*288(CIF)
Bitrate Type	Constant
Video Quality	Medium
Frame Rate	Full Frame
Max. Bitrate Mode	General
Max. Bitrate (Kbps) (max.: 3M)	512
Max. Bitrate Range Recommend...	384~640(Kbps)
Video Encoding	H.265

Figure 5-8 Sub-Stream Encoding

2) Select a camera in the camera drop-down list.

3) Configure the parameters.

4) Click **Apply** to save the settings.

5) (Optional) If the parameters can also be used to other cameras, click **Copy** to copy the settings to other channels.

 **NOTE**

- The resolution of sub-stream can be selected among WD1, 4CIF, and CIF.
- The minimum frame rate for the sub-stream is 1 fps.
- You can select **Video Encoding** for the sub-stream of IP and analog cameras. For the analog cameras, H.264 and H.265 are selectable. For the IP cameras supporting H.265, you can select H.265 encoding mode.

Step 8 Set parameters for capture.

1) Select **Capture**.

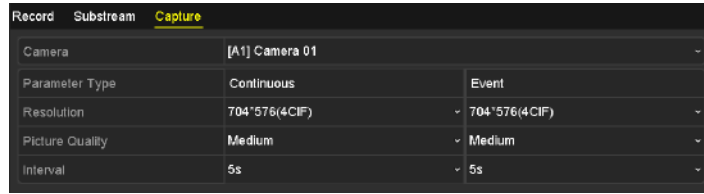

Figure 5-9 Capture Settings

- 2) Select a camera from the drop-down list.
- 3) Configure the parameters.
- 4) Click **Apply** to save the settings.
- 5) (Optional) If the parameters can also be used to other cameras, click **Copy** to copy the settings to other channels.

 **NOTE**

The interval is the time period between two capturing actions. You can configure all the parameters on this menu on your demand.

5.2 Configuring Recording and Capture Schedule

 **NOTE**

- The DVR supports continuous, alarm, motion, motion | alarm, motion & alarm, event, and POS (for DS-7300HQHI and DS-7300/9000HUHI-K) triggered recording types.
- In this chapter, we take the record schedule procedure as an example, and the same procedure can be applied to configure schedule for recording.

Purpose

Set the record schedule, and then the camera will automatically start/stop recording according to the configured schedule.

Step 1 Go to **Menu > Record/Capture > Schedule**.

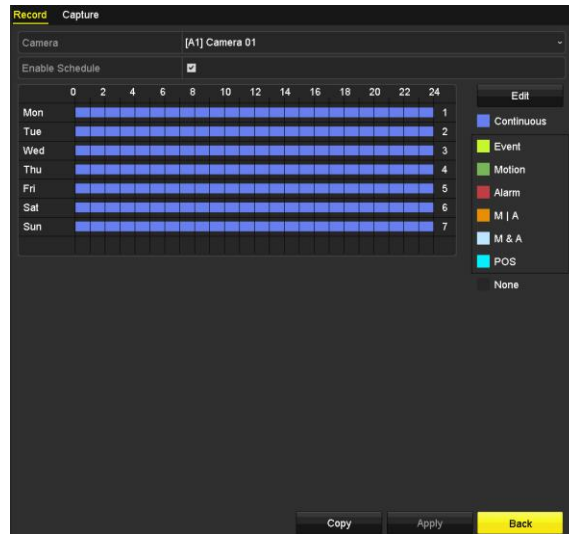

Figure 5-10 Record Schedule

Different recording types are marked in different color icons.

Continuous: scheduled recording.

Event: recording triggered by all event triggered alarm.

Motion: recording triggered by motion detection.

Alarm: recording triggered by alarm.

M/A: recording triggered by either motion detection or alarm.

M&A: recording triggered by motion detection and alarm.

POS: recording triggered by POS and alarm.

NOTE

The POS recording is supported by DS-7300HQHI and DS-7300/9000HUHI-K series DVR only.

Step 2 Choose the camera you want to configure in **Camera**.

Step 3 Check **Enable Schedule**.

Step 4 Configure the record schedule.

Edit the schedule

- 1) Click **Edit**.
- 2) In the message box, you can choose the day to which you want to set schedule.
- 3) To schedule an all-day recording, check the checkbox after **All Day**.

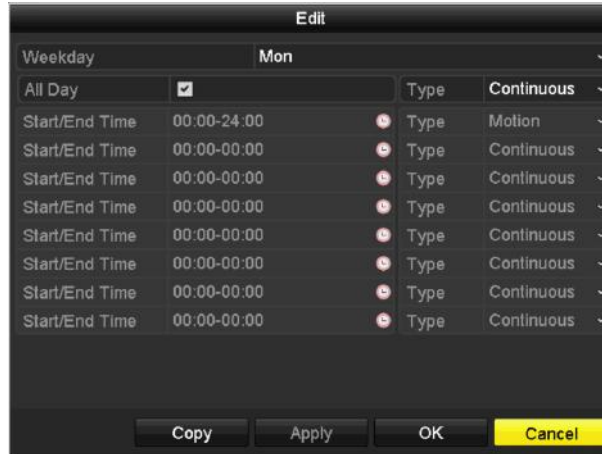

Figure 5-11 Edit Schedule- All Day

- 4) To arrange other schedule, leave **All Day** blank and set the Start/End time.

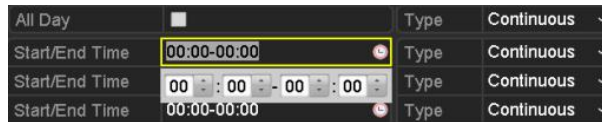

Figure 5-12 Edit Schedule- Set Time Period

NOTE

- Up to 8 periods can be configured for each day. And the time periods cannot be overlapped with each other.
 - To enable Event, Motion, Alarm, M | A (motion or alarm), M & A (motion and alarm), and POS triggered recording, you must configure the motion detection settings, alarm input settings or VCA settings as well. For detailed information, refer to *Chapter 8.1*, *Chapter 8.7* and *Chapter 9*.
- 5) Repeat the above steps 1)-4) to schedule recording for other days in the week. If the schedule can also be set to other days, click **Copy**.

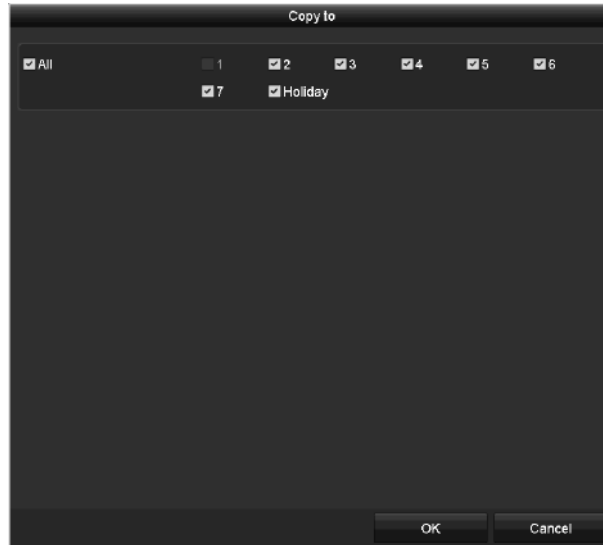

Figure 5-13 Copy Schedule to Other Days

NOTE

The **Holiday** option is available when you enable holiday schedule in **Holiday settings**. See *Chapter 5.7 Configuring Holiday Record*.

- 6) Click **OK** to save the settings and return to upper level menu.

Draw the schedule

- 1) Click the color icon to select a record type in the event list on the right-side of the interface.



Figure 5-14 Draw the Recording Schedule

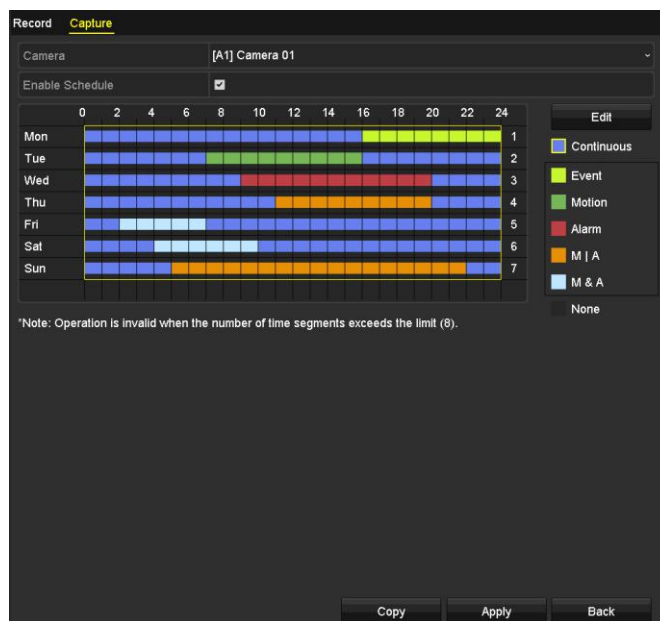

Figure 5-15 Draw the Capture Schedule

- 2) Drag the mouse on the schedule.
- 3) Click the other area except for the schedule table to finish and exit from the drawing.

You can repeat step 4 to set schedule for other channels. If the settings can also be used to other channels, click **Copy**, and then choose the channel to which you want to copy to.

Step 5 Click **Apply** in the **Record Schedule** interface to save the settings.

5.3 Configuring Motion Detection Recording and Capture

Purpose

Follow the steps to set the motion detection parameters. In the live view mode, once a motion detection event takes place, the DVR can analyze it and do many actions to handle it. Enabling motion detection function can trigger certain channels to start recording, or trigger full screen monitoring, audio warning, notifying the surveillance center, sending email and so on.

Step 1 Go to **Menu>Camera>Motion**.

Step 2 Configure Motion Detection:

- 1) Choose camera you want to configure.
- 2) Check **Enable Motion Detection**.
- 3) Check **False Alarm Filter**. Refer to *Chapter 8.2 Setting PIR Camera Alarm* for details.
- 4) Drag and draw the area for motion detection by mouse. If you want to set the motion detection for all the area shot by the camera, click **Full Screen**. To clear the motion detection area, click **Clear**.

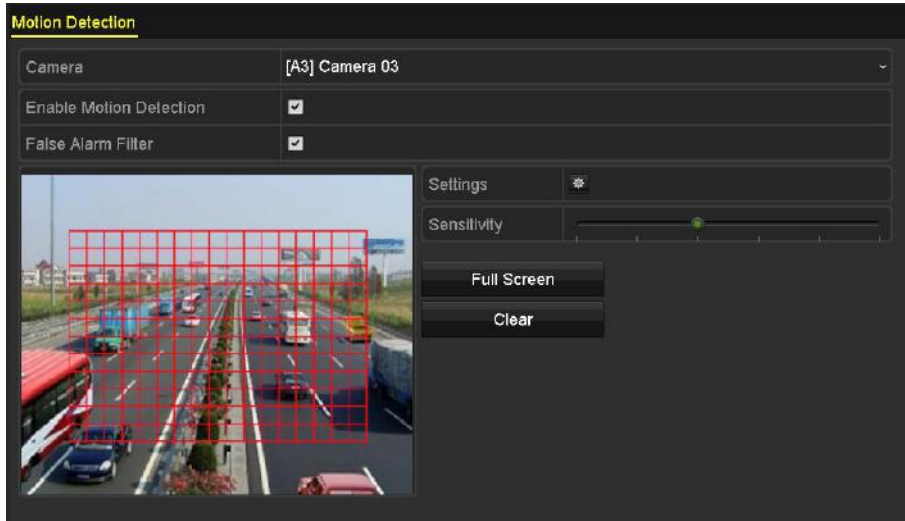



Figure 5-16 Motion Detection- Mask

- 5) Click , and the message box for channel information pops up.

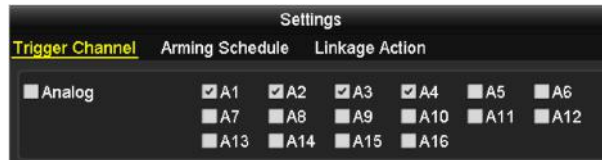

Figure 5-17 Motion Detection Settings

- 6) Select the channels which you want the motion detection event to trigger recording.
 7) Click **Apply** to save the settings.
 8) Click **OK** to back to the upper level menu.
 9) Exit the **Motion Detection** menu.

Step 3 Configure the schedule.

Please refer to the step 4 of *Chapter 5.2 Configuring Recording and Capture Schedule*, while you may choose Motion as the record type.

5.4 Configuring Alarm Triggered Recording and Capture

Purpose

Follow the procedure to configure alarm triggered recording or capture.

Step 1 Go to **Menu > Configuration > Alarm > Alarm Input**.

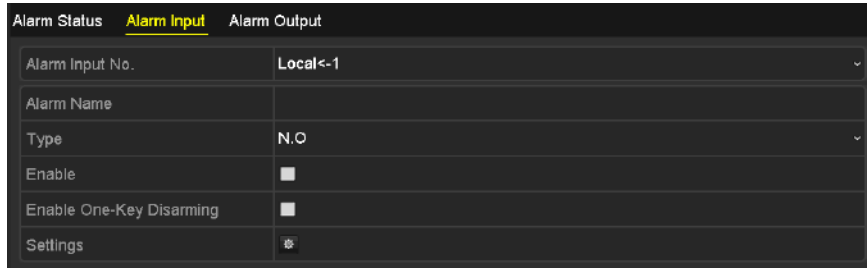

Figure 5-18 Alarm Settings- Alarm Input

Step 2 Select **Alarm Input No.**

Step 3 Input **Alarm Name.**

Step 4 Select **N.O** (normally open) or **N.C** (normally closed) for alarm type.

Step 5 Check **Enable** to enable alarm.



Figure 5-19 Enable Alarm

Step 6 Click the  button after **Settings** to set the triggered channels, arming schedule, linkage actions and PTZ linking. Refer to step 4 of *Chapter 5.2 Configuring Recording and Capture Schedule* for detailed operations.

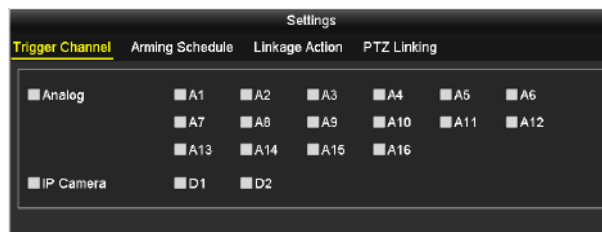

Figure 5-20 Alarm Handling

Step 7 Click **Apply** to save the settings.

Repeat the steps from 1 to 8 to configure other alarm input parameters.

If the settings can also be applied to other alarm inputs, click **Copy** and choose the alarm input number.



Figure 5-21 Copy Alarm Input

5.5 Configuring Event Recording and Capture

Purpose

The event triggered recording can be configured through the menu. Then events include the motion detection, alarm and VCA events (face detection/face capture, line crossing detection, intrusion detection, region entrance detection, region exiting detection, loitering detection, people gathering detection, fast moving detection, parking detection, unattended baggage detection, object removal detection, audio loss exception detection, sudden change of sound intensity detection, and defocus detection).

NOTE

- HTHI series DVR support full-channel line crossing detection and intrusion detection, and 2-ch sudden scene change detection. Channels with audio support audio exception detection.
- For HUHI series DVR, if enhanced VCA mode is enabled, full-channel line crossing detection and intrusion detection, and 2-ch sudden scene change detection are supported, but 2K/4K output and 4 MP/5 MP/8 MP signal input are not supported; if enhanced VCA mode is disabled, 2-ch line crossing detection and intrusion detection, and 2-ch sudden scene change detection are supported, and 2K/4K output and 4 MP/5 MP/8 MP signal input are also supported.
- DS-7200HQHI series support up to 4-ch line crossing detection and intrusion detection if enhanced VCA mode is enabled. DS-7216HQHI series also support 1-ch sudden scene change detection. Channels with audio support audio exception detection.
- DS-7300HQHI-K series support up to 4-ch line crossing detection and intrusion detection if enhanced VCA mode is enabled, and 1-ch sudden scene change detection. Channels with audio support audio exception detection.
- For the analog channels, the line crossing detection and intrusion detection conflict with other VCA detection such as sudden scene change detection, face detection and vehicle detection. You can only enable one function.

Step 1 Go to **Menu > Camera > VCA**.

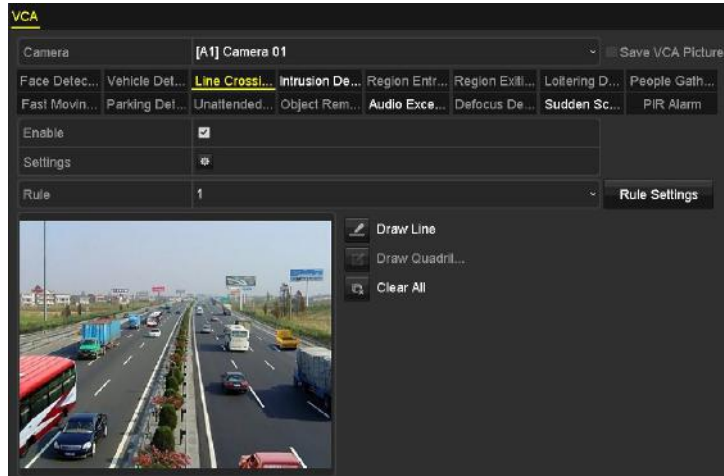



Figure 5-22 VCA Settings

Step 2 Select a **Camera**.

Step 3 Configure the detection rules for VCA events. For details, see the step 6 in *Chapter 10.3 Line Crossing Detection*.

Step 4 Click the icon  to configure the alarm linkage actions for the VCA events.

Select **Trigger Channel** tab and select one or more channels which will start to record when VCA alarm is triggered.

Step 5 Click **Apply** to save the settings.

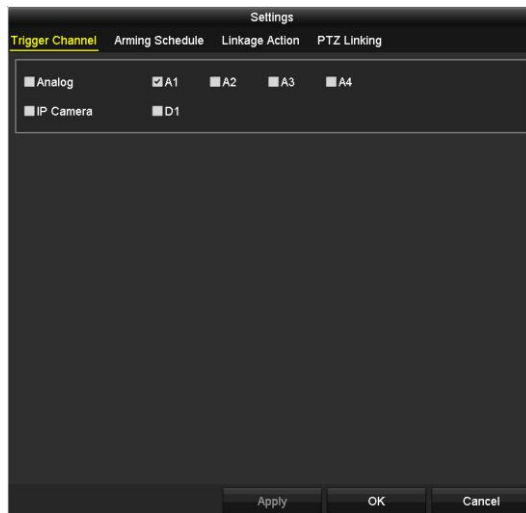

Figure 5-23 Set Triggered Camera of VCA Alarm

Step 6 Enter **Record Schedule Settings** interface (Menu> Record> Schedule>Record Schedule), and then set Event as the record type. For details, see step 2 in *Chapter 5.2 Configuring Recording and Capture Schedule*.

5.6 Configuring Manual Recording and Continuous Capture

Purpose

Follow the steps to set parameters for the manual recording and continuous capture. Using manual recording and continuous capture, you need to manually cancel the record and capture. The manual recording and manual continuous capture is prior to the scheduled recording and capture.

Step 1 Go to **Menu > Manual > Record**.

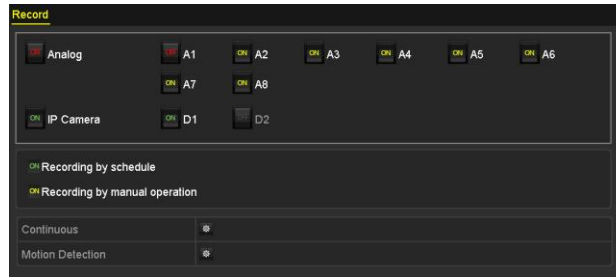

Figure 5-24 Manual Record

Step 2 Enable manual record.

Click the status icon **OFF** before camera number to change it to **ON**.

Or click the status icon **OFF** of **Analog** to enable manual record of all channels.

Step 3 Disable manual record.

Click the status icon **ON** to change it to **OFF**.

Or click the status icon **ON** of **Analog** to disable manual record of all channels.

NOTE

After rebooting all the manual records enabled are canceled.

5.7 Configuring Holiday Recording and Capture

Purpose

Follow the steps to configure the record or capture schedule on holiday for that year. You may want to have different plan for recording on holiday.

Step 1 Go to **Menu > Record > Holiday**.

No.	Holiday Name	Status	Start Date	End Date	Edit
1	Holiday1	Enabled	1.Jan	1.Jan	
2	Holiday2	Disabled	1.Jan	1.Jan	
3	Holiday3	Disabled	1.Jan	1.Jan	
4	Holiday4	Disabled	1.Jan	1.Jan	
5	Holiday5	Disabled	1.Jan	1.Jan	
6	Holiday6	Disabled	1.Jan	1.Jan	
7	Holiday7	Disabled	1.Jan	1.Jan	
8	Holiday8	Disabled	1.Jan	1.Jan	
9	Holiday9	Disabled	1.Jan	1.Jan	
10	Holiday10	Disabled	1.Jan	1.Jan	
11	Holiday11	Disabled	1.Jan	1.Jan	
12	Holiday12	Disabled	1.Jan	1.Jan	

Figure 5-25 Holiday Settings

Step 2 Enable Edit Holiday schedule.

- 1) Click to enter the Edit interface.

Edit	
Holiday Name	Holiday1
Enable	<input type="checkbox"/>
Mode	By Month
Start Date	Jan 1
End Date	Jan 1
<input type="button" value="Apply"/> <input type="button" value="OK"/> <input type="button" value="Cancel"/>	

Figure 5-26 Edit Holiday Settings

- 2) Check **Enable**.
- 3) Select Mode from the drop-down list.

There are three different modes for the date format to configure holiday schedule. By Month, By Week, and By Date are selectable.

- 4) Set the start and end date.
- 5) Click **Apply** to save settings.
- 6) Click **OK** to exit the Edit interface.

Step 3 Configure the record schedule.

Please refer to the *Chapter 5.2 Configuring Recording and Capture Schedule*, while you may choose Holiday in the Schedule drop-down list, or you can draw the schedule on the timeline of Holiday.

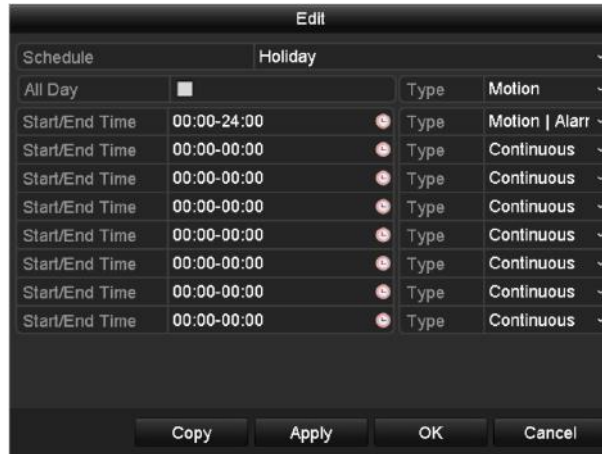

Figure 5-27 Edit Schedule- Holiday

NOTE

- Up to 8 periods can be configured for each day. And the time periods cannot be overlapped each other.
- In the time table of the channel, both holiday schedule and normal day schedule are displayed.
- Repeat the above step 4 to set Holiday schedule for other channels. If the holiday schedule can also be used to other channels, click **Copy** and choose the channel you want to apply the settings.

5.8 Configuring Redundant Recording and Capture

Purpose

Enabling redundant recording and capture, which means saving the record files and captured pictures not only in the R/W HDD but also in the redundant HDD, will effectively enhance the data safety and reliability.

Before you start

You must set the Storage mode in the HDD advanced settings to *Group* before you set the HDD property to Redundant. For detailed information, please refer to *Chapter 14.3 Managing HDD Group*. There should be at least another HDD which is in Read/Write status.

Step 1 Go to **Menu > HDD**.

Label	Capacity	Status	Property	Type	Free Space	Group	Edit	Delete
1	931.51GB	Normal	R/W	Local	865GB	1		-
3	931.51GB	Normal	R/W	Local	931GB	1		-

Figure 5-28 HDD General

Step 2 Select **HDD** and click to enter the Local HDD Settings interface.

- 1) Set the HDD property to Redundant.



Figure 5-29 HDD General-Editing

- 2) Click **Apply** to save the settings.
- 3) Click **OK** to back to the upper level menu.

Step 3 Go to **Menu > Record > Parameters > Record**.

- 1) Select Camera you want to configure.
- 2) Click **More Settings**.



Figure 5-30 More Settings

- 3) Check **Redundant Record**.
- 4) Click **OK** to save the settings.
- 5) If the encoding parameters can also be used to other channels, click **Copy** and choose the channel you want to apply the settings.

5.9 Configuring HDD Group

Purpose

You can group the HDDs and save the record files in certain HDD group.

Step 1 Go to **Menu > HDD > Advanced > Storage Mode**.

Check whether the storage mode of the HDD is Group. If not, set it to Group. For detailed information, please refer to *Chapter 14.3 Managing HDD Group*.

Step 2 Select **General** in the left bar.

Click  to enter editing interface.

Step 3 Configuring HDD group.

- 1) Choose a group number for the HDD group.
- 2) Click **Apply** to save your settings.
- 3) Click **OK** to back to the upper level menu.

Step 4 Repeat the above steps to configure more HDD groups.

Step 5 Choose the Channels which you want to save the record files in the HDD group.

- 1) Go to **Menu > HDD > Advanced > Storage Mode**.

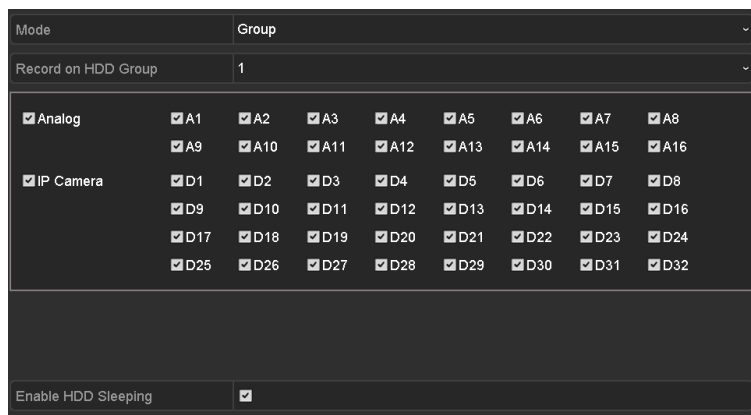

Figure 5-31 HDD Advanced

- 2) Choose Group number in **Record on HDD Group**
- 3) Check the channels you want to save in this group.
- 4) Click **Apply** to save settings.

 **NOTE**

After you have configured the HDD groups, you can configure the recording settings following the procedure provided in *Chapter 5.2-5.7*.

5.10 Files Protection

Purpose

You can lock the recorded files or set the HDD property to Read-only to protect the record files from being overwritten.

Protect file by locking the record files

Step 1 Go to **Menu > Export > Normal**.

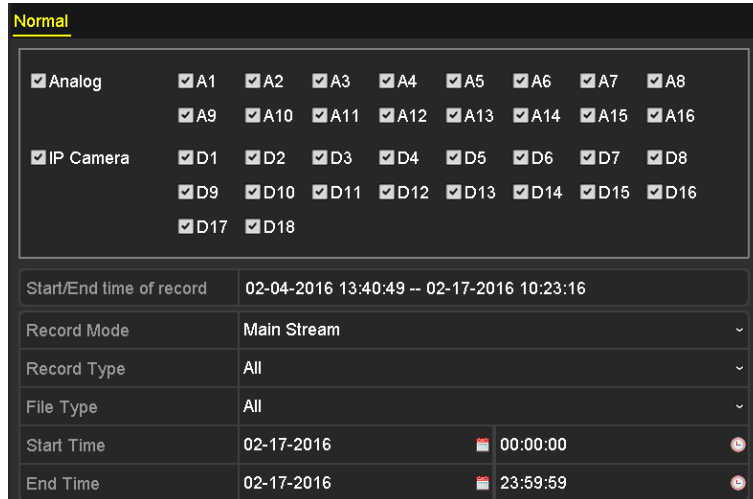

Figure 5-32 Export

Step 2 Select the channels you want to investigate by checking the checkbox to .

Step 3 Configure the record mode, record type, file type, start time and end time.

Step 4 Click **Search** to show the results.

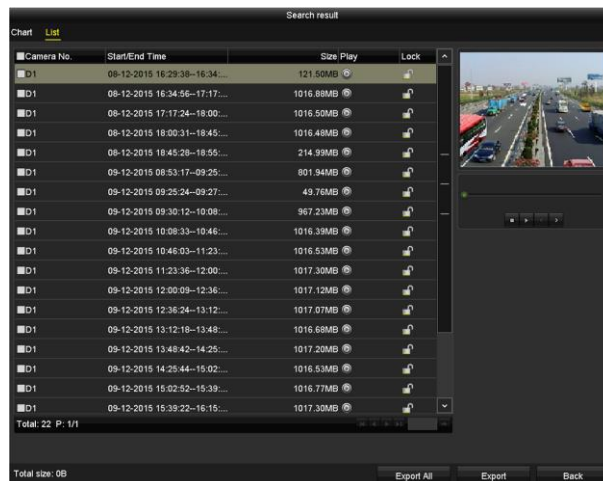



Figure 5-33 Export-Search Result

Step 5 Protect the record files.

- 1) Find the record files you want to protect, and then click the  icon which will turn to , indicating that the file is locked.



NOTE

The record files of which the recording is still not completed cannot be locked.

2) Click  to change it to  to unlock the file and the file is not protected.

Protect file by setting HDD property to Read-only

Before you start

To edit HDD property, you need to set the storage mode of the HDD to Group. See *Chapter 14.3 Managing HDD Group*.

Step 1 Go to **Menu > HDD > General**.

<input type="checkbox"/>	Label	Capacity	Status	Property	Type	Free Space	Group	Edit	Delete
<input type="checkbox"/>	1	931.51GB	Normal	R/W	Local	865GB	1		-
<input type="checkbox"/>	3	931.51GB	Normal	R/W	Local	931GB	1		-

Figure 5-34 HDD General

Step 2 Click  to edit the HDD you want to protect.

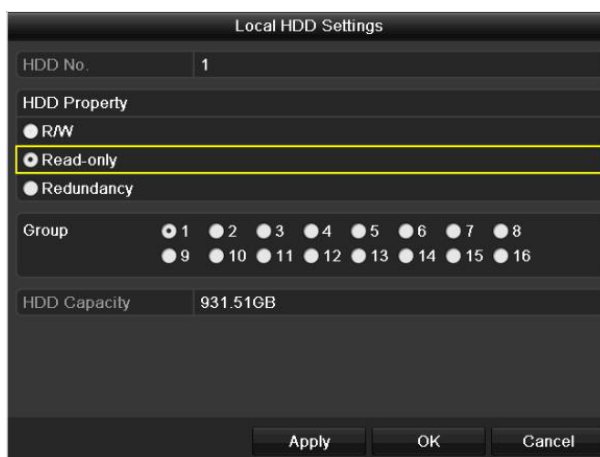

The dialog box titled "Local HDD Settings" shows the configuration for HDD No. 1. Under "HDD Property", the "Read-only" option is selected and highlighted with a yellow box. Other options include "R/W" and "Redundancy". The "Group" section shows radio buttons for groups 1 through 16. The "HDD Capacity" is listed as 931.51GB. At the bottom, there are "Apply", "OK", and "Cancel" buttons.

Figure 5-35 HDD General- Editing

Step 3 Set the HDD to Read-only.

Step 4 Click **OK** to save settings and back to the upper level menu.

NOTE

- You cannot save any files in a Read-only HDD. If you want to save files in the HDD, change the property to R/W.
- If there is only one HDD and is set to Read-only, the DVR cannot record any files. Only live view mode is available.
- If you set the HDD to Read-only when the DVR is saving files in it, then the file will be saved in next R/W HDD. If there is only one HDD, the recording will be stopped.

5.11 One-Key Enabling and Disabling H.264+/H.265+ for Analog Cameras

Purpose

You can one-key enable or disable H.264+/H.265+ for the analog cameras.

Task 1: One-Key Enabling H.264+/H.265+ for All Analog Cameras

Step 1 Go to **Menu > Record > Advanced**.

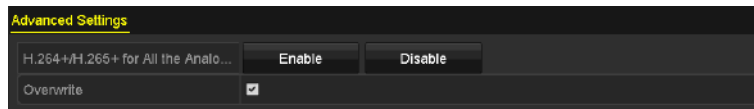

Figure 5-36 Advanced Settings (for DS-7200HUHI and HTHI series DVR)

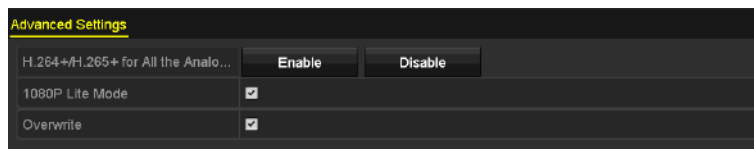

Figure 5-37 Advanced Settings (for HQHI series DVR)

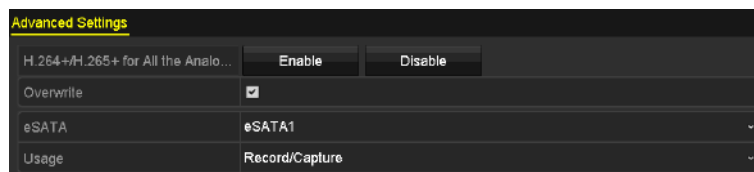

Figure 5-38 Advanced Settings (for DS-7300/9000HUHI series DVR)

Step 2 Click **Enable** to enable H.264+/H.265+ for all the analog cameras and the following attention box pops up.

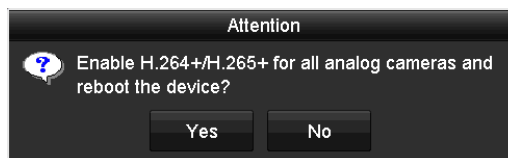

Figure 5-39 Attention Box

Step 3 Click **Yes** to enable the function and reboot the device to have new settings taken effect.

Task 2: One-Key Disabling H.264+/H.265+ for All Analog Cameras

Step 1 Go to **Menu > Record > Advanced**.

Step 2 Click **Disable** to disable H.264+/H.265+ for all the analog cameras and the following attention box pops up.



Figure 5-40 Attention Box

Step 3 Click **Yes** to enable the function and reboot the device to have new settings taken effect.

5.12 Configuring 1080P Lite

Purpose

When the 1080P Lite Mode is enabled, the encoding resolution at 1080P Lite (real-time) is supported. If not, up to 1080P (non-real-time) is supported.



This chapter is applicable to HQHI series DVR.

Task 1: Enabling the 1080P Lite Mode

Step 1 Go to **Menu > Record > Advanced**.

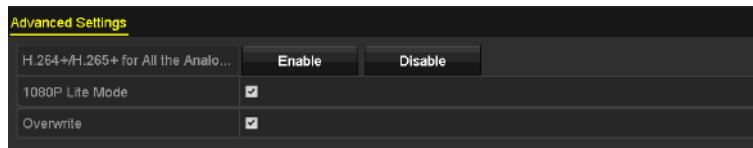

Figure 5-41 Advanced Interface

Step 2 Check the checkbox of **1080P Lite Mode** and click **Apply** to pop up the attention box. After enabling 1080p lite mode, the 3 MP signal is not accessible to analog channel.

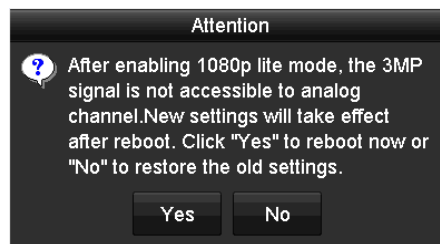

Figure 5-42 Attention

Step 3 Click **Yes** to reboot the device to have new settings taken effect.

Task 2: Disabling the 1080P Lite Mode

Step 1 Go to **Menu > Record > Advanced**.

Step 2 Uncheck **1080P Lite Mode** and click **Apply**. The following attention box pops up.



Figure 5-43 Attention

Step 3 Click **Yes** to reboot the device to activate the new settings or **No** to restore the old settings.

Chapter 6 Playback

6.1 Playing Back Record Files

6.1.1 Instant Playback

Purpose

Play back the recorded video files of a specific channel in the live view mode. Channel switch is supported.

Instant playback by channel

Choose a channel in live view mode and click the  button in the quick setting toolbar.

NOTE

In the instant playback mode, only record files recorded during the last five minutes on this channel will be played back.



Figure 6-1 Instant Playback Interface

6.1.2 Playing Back by Normal Search

Playback by Channel

Enter the **Playback** interface.

Right click a channel in live view mode and select **Playback** from the menu, as shown in the following figure:

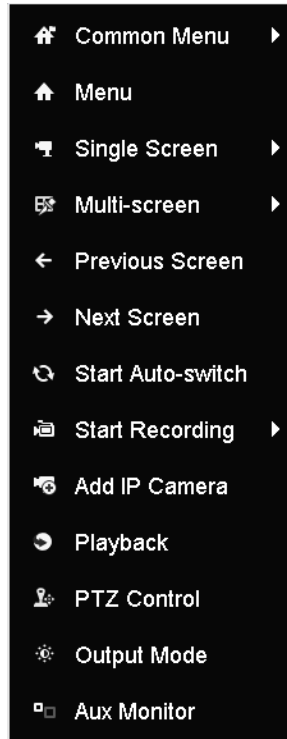

Figure 6-2 Right-click Menu under Live View

Playback by Time

Purpose

Play back video files recorded in specified time duration. Multi-channel simultaneous playback and channel switch are supported.



Step 1 Go to **Menu > Playback**.

Step 2 Check the checkbox of channel(s) in the channel list and then double-click to select a date on the calendar.



Figure 6-3 Playback Calendar

NOTE

If there are record files for that camera in that day, in the calendar, the icon for that day is displayed as . Otherwise it is displayed as .

Playback Interface

You can select the main stream or sub-stream from the drop-down list for playback.

You can also use the toolbar in the bottom part of **Playback** interface to control playing progress, as shown in the following figure.



Figure 6-4 Playback Interface

Select the channel(s) if you want to switch playback to another channel or execute simultaneous playback of multiple channels.



Figure 6-5 Toolbar of Playback

Table 6-1 Detailed Explanation of Playback Toolbar

Button	Operation	Button	Operation	Button	Operation
	Audio on/Mute		Start/Stop clipping		Lock File
	Add default tag		Add customized tag		File management for video clips, captured

Button	Operation	Button	Operation	Button	Operation
					pictures, locked files and tags
	Reverse play/Pause		Stop		Digital Zoom
	30s forward		30s reverse		Pause/Play
	Fast forward		Previous day		Slow forward
	Full Screen		Exit		Next day
	Save the clips		Process bar		Scaling up/down the time line
	Capture Picture		Enable/Disable POS information overlay		

NOTE

- The indicates the start time and end time of the record files.
- represents normal recording (manual or schedule); represents event recording (motion, alarm, motion | alarm, motion & alarm).
- Playback progress bar: use the mouse to click any point of the progress bar to locate special frames.
- The POS overlay function is supported by DS-7300HQHI and DS-7300/9000HUHI-K series DVR only. When the POS is enabled when playing back, the POS information will be overlaid on the video. And the keyword searching is supported.
- The picture capture function is supported by DS-7300/9000HUHI-K series DVR only.

6.1.3 Playing Back by Event Search

Purpose

Play back record files on one or several channels searched out by restricting event type (motion detection, alarm input or VCA). Channel switch is supported.

Step 1 Go to **Menu > Playback**.

Step 2 Click and select to enter the **Event Playback** interface.

Step 3 Select **Alarm Input, Motion, VCA** as the event type, and specify the start time and end time for search.

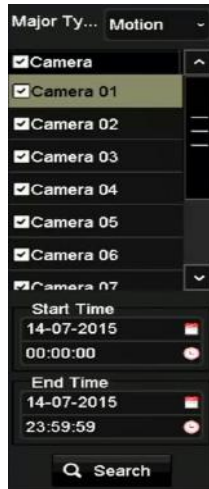



Figure 6-6 Video Search by Motion Detection

Step 4 Click **Search**, and the record files matching the search conditions will be displayed on a list.

Step 5 Select and click  button to play back the record files.

You can click **Back** to return to the search interface.

If there is only one channel triggered, clicking  button takes you to **Full-screen Playback** interface of this channel.

If several channels are triggered, clicking  button takes you to the **Synchronous Playback** interface. Check checkbox to select one channel for playback or select multiple channels for synchronous playback.

 **NOTE**

The maximum number of channels for synchronous playback supported varies to different models.



Figure 6-7 Select Channels for Synchronous Playback

Step 6 On the **Event Playback** interface, you can select the main stream or sub-stream from the drop-down list for playback.

The toolbar in the bottom part of **Playback** interface can be used to control playing process.



Figure 6-8 Interface of Playback by Event

Pre-play and post-play can be configured for the playback of event triggered record files.

Pre-play: The time you set to play back before the event. For example, when an alarm triggered the recording at 10:00, if you set the pre-play time as 5 seconds, the video plays back from 9:59:55.

Post-play: The time you set to play back after the event. For example, when an alarm triggered the recording ends at 11:00, if you set the post-play time as 5 seconds, the video plays back till 11:00:05.

Step 7 You can click ◀ or ▶ button to select the previous or next event. Please refer to Table 6-1 for the description of buttons on the toolbar.

6.1.4 Playing Back by Tag

Purpose

Video tag allows you to record related information like people and location of a certain time point during playback. You are also allowed to use video tag(s) to search for record files and position time point.

Before playing back by tag

Step 1 Go to **Menu > Playback**.

Step 2 Search and play back the record file(s). Refer to *Chapter 6.1.2 Playing Back by Normal Search* for the detailed information about searching and playback of the record files.



Figure 6-9 Interface of Playback by Time

Click  button to add default tag.

Click  button to add customized tag and input tag name.

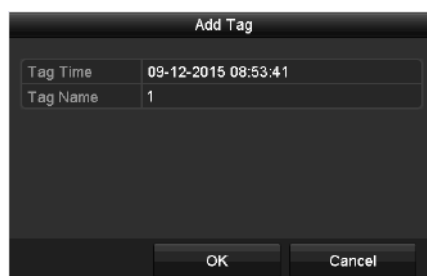

Figure 6-10 Add Tag

NOTE

Max. 64 tags can be added to a single video file.

Step 3 Tag management.

Click  button to check, edit and delete tag(s).



Figure 6-11 Tag Management Interface

Steps

Step 1 Select **Tag** from the drop-down list in the **Playback** interface.

Step 2 Choose channels, edit start time and end time, and then click **Search** to enter **Search Result** interface.



NOTE

You can enter keyword in the textbox to search the tag on your command.





Figure 6-12 Video Search by Tag

Step 3 Click  button to play back the file.

You can click **Back** to return to the search interface.

 **NOTE**

- Pre-play and post-play can be configured.
- You can click  or  button to select the previous or next tag. Please refer to Table 6-1 for the description of buttons on the toolbar.

6.1.5 Playing Back by Smart Search

Purpose

The smart playback function provides an easy way to get through the less effective information. When you select the smart playback mode, the system will analyze the video containing the motion or VCA information, mark it with green color and play it in the normal speed while the video without motion will be played in the 16-time speed. The smart playback rules and areas are configurable.

Before you start

To get the smart search result, the corresponding event type must be enabled and configured on the IP camera. Here we take the intrusion detection as an example.

Step 1 Log in the IP camera by the web browser, and enable the intrusion detection by checking the checkbox of it. You may enter the motion detection configuration interface by Configuration > Advanced Configuration > Events > Intrusion Detection.

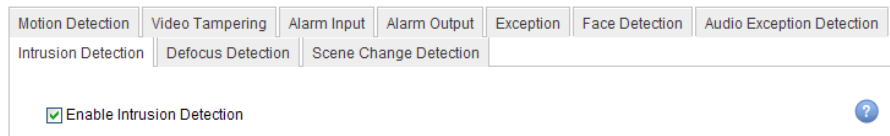

Figure 6-13 Setting Intrusion Detection on IP Camera

Step 2 Configure the required parameters of intrusion detection, including area, arming schedule and linkage methods. Refer to the user manual of smart IP camera for detailed instructions.

Steps

Step 1 Go to **Menu > Playback**.

Step 2 Select **Smart** in the drop-down list on the top-left side.

Step 3 Select a camera in the camera list.















Figure 6-14 Smart Playback Interface

Step 4 Select a date in the calendar and click the  button to play.

Refer to Table 6-2 for the descriptions of the buttons on the Smart Playback Toolbar.

Table 6-2 Detailed Explanation of Smart Playback Toolbar

Button	Operation	Button	Operation	Button	Operation
	Draw line for the line crossing detection		Draw quadrilateral for the intrusion detection		Draw rectangle for the intrusion detection
	Set full screen for motion detection		Clear all		Start/Stop clipping
	File management for video clips		Stop playing		Pause playing /Play
	Smart settings		Search matched video files		Filter video files by setting the target characters
	Show/Hide VCA information				

Step 5 Set the rules and areas for smart search of VCA event or motion event.



- **Line Crossing Detection**

Select the  button , and click on the image to specify the start point and end point of the line.

- **Intrusion Detection**

Click the  button, and specify 4 points to set a quadrilateral region for intrusion detection. Only one region can be set.

- **Motion Detection**

Click the  button and then click and draw the mouse to set the detection area manually. You can also click the  button to set the full screen as the detection area.

Step 6 Click  to configure the smart settings.



Figure 6-15 Smart Settings

Skip the Non-Related Video: The non-related video will not be played if this function is enabled.

Play Non-Related Video at: Set the speed to play the non-related video. Max. 8/4/2/1 are selectable.

Play Related Video at: Set the speed to play the related video. Max. 8/4/2/1 are selectable.



NOTE

Pre-play and post-play is not available for the motion event type.

Step 7 Click to search and play the matched video files.

Step 8 (Optional) Click to filter the searched video files by setting the target characters, including the gender and age of the human and whether he/she wears glasses.



Figure 6-16 Set Result Filter



NOTE

The Result Filter function is supported by the IP camera only.

Step 9 (Optional) For the cameras supporting VCA, click to show the VCA information.

Then the configured line or quadrilateral in VCA configuration and target frame(s) will be shown on the playback interface. Click to hide the VCA information.

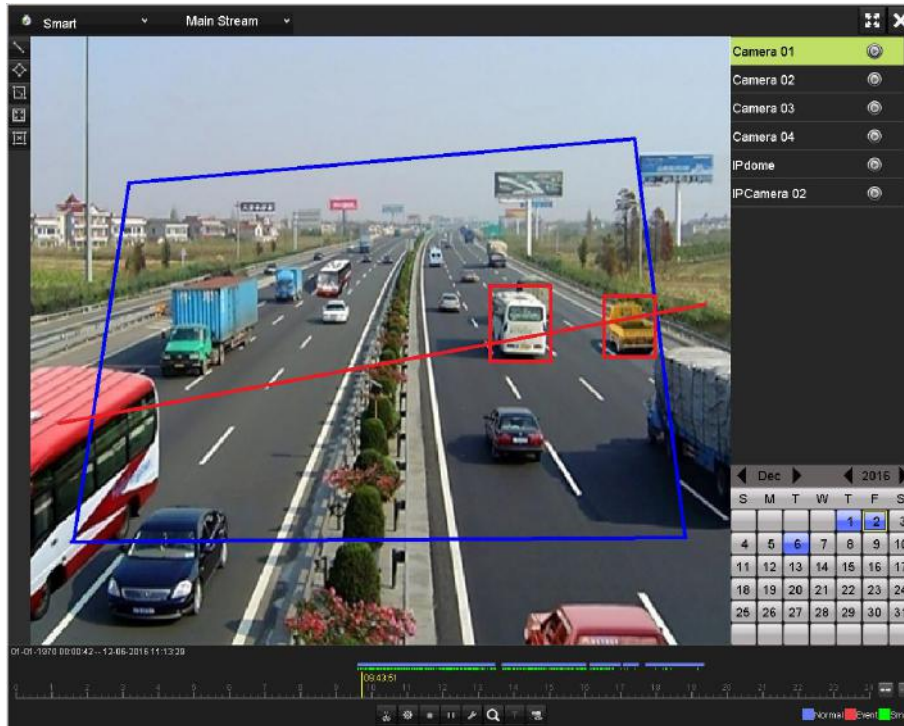

Figure 6-17 Show VCA Information

i NOTE

- This function is supported by HUIH and HTHI series DVR.
- In smart playback, both the analog and IP cameras support VCA information overlay.
- If the connected camera does not support VCA, the icon is grey and unavailable.
- For the analog cameras, the VCA information includes line crossing detection and intrusion detection. For the IP cameras, the VCA information includes all the VCA detections of smart IP camera.

6.1.6 Playing Back by System Logs

Purpose

Play back record file(s) associated with channels after searching system logs.

Step 1 Go to **Menu > Maintenance > Log Information > Log Search**.

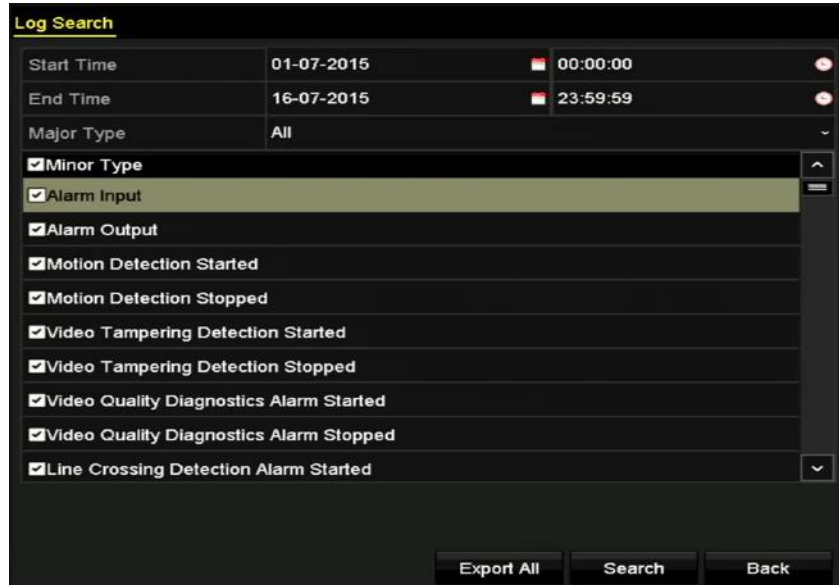



Figure 6-18 System Log Search Interface

Step 2 Set search time and type and click **Search**.



Figure 6-19 Result of System Log Search

Step 3 Choose a log with record file and click  button to enter **Playback** interface.

 **NOTE**

If there is no record file at the time point of the log, the message box “No result found” will pop up.

Step 4 Playback management.

The toolbar in the bottom part of Playback interface can be used to control playing process.



Figure 6-20 Interface of Playback by Log

6.1.7 Playing Back by Sub-Periods

Purpose

The video files can be played in multiple sub-periods simultaneously on the screens.

Step 1 Go to **Menu > Playback**.

Step 2 Select **Sub-periods** from the drop-down list in the upper-left corner of the page to enter the **Sub-periods Playback** interface.

Step 3 Select a date and start playing the video file.

Step 4 Select the **Split-screen Number** from the drop-down list. Up to 16 screens are configurable.

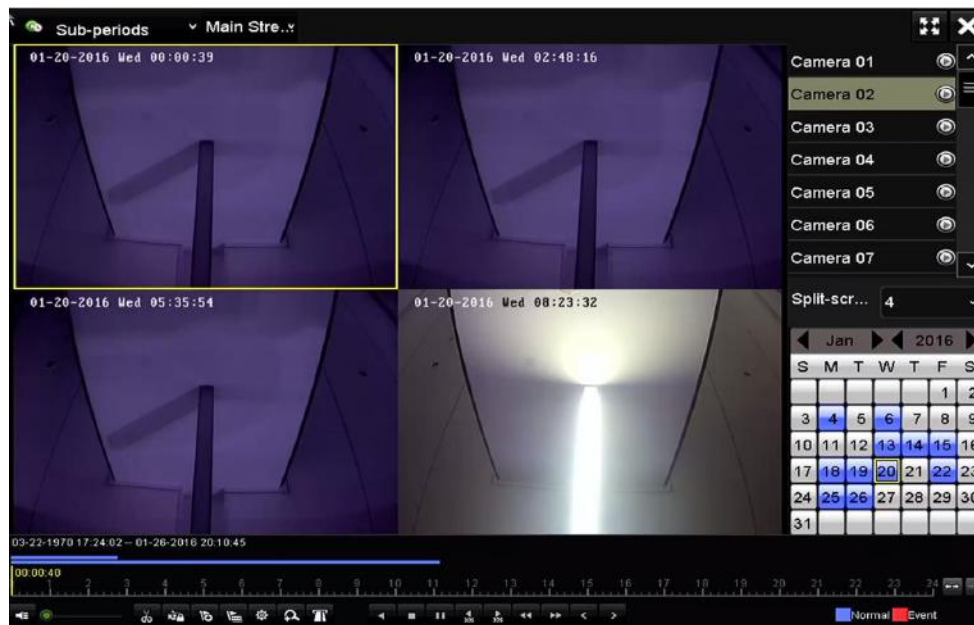

Figure 6-21 Interface of Sub-periods Playback



NOTE

According to the defined number of split-screens, the video files on the selected date can be divided into average segments for playback. E.g., if there are video files existing between 16:00 and

22:00, and the 6-screen display mode is selected, then it can play the video files for 1 hour on each screen simultaneously.

6.1.8 Playing Back External File

Purpose

Perform the following steps to look up and play back files in the external devices.

Step 1 Go to **Menu > Playback**.

Step 2 Select the **External File** in the drop-down list on the top-left side.

The files are listed in the right-side list.

You can click the  Refresh button to refresh the file list.

Step 3 Select and click the  button to play back it.



Figure 6-22 Interface of External File Playback

6.1.9 Playing Back Pictures



NOTE

This chapter is only applicable to DS-7300/9000HUHI-K series DVR.

Purpose

The captured pictures stored in the HDDs of the device can be searched and viewed.

Step 1 Enter Playback interface.

Step 2 Select **Picture** from the drop-down list in the upper-left corner of the page to enter the Picture Playback interface.

Step 3 Check checkbox to select the channel(s) and specify the start time and end time for search.

Step 4 Click **Search** to enter Search Result interface.

 **NOTE**

Up to 4000 pictures can be displayed each time.

Step 5 Choose a picture you want to view and click  button.

You can click **Back** to return to the search interface.



Figure 6-23 Result of Picture Playback

Step 6 The toolbar in the bottom part of Playback interface can be used to control playing process.

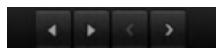





Figure 6-24 Picture Playback Toolbar

Table 6-3 Detailed Explanation of Picture Playback Toolbar

Button	Function	Button	Function	Button	Function	Button	Function
	Play reverse		Play		Previous picture		Next picture

6.2 Auxiliary Functions of Playback

6.2.1 Playing Back Frame by Frame

Purpose

Play video files frame by frame, in order to check image details of the video when abnormal events happen.

Step 1 Go to Playback interface and click button  until the speed changes to *Single* frame.

Step 2 One click on the playback screen represents playback or adverse playback of one frame.
You can use button  in toolbar to stop the playing.

6.2.2 Digital Zoom

Step 1 Click the  button on the playback control bar to enter Digital Zoom interface.



Step 2 You can zoom in the image to different proportions (1 to 16X) by moving the sliding bar from  to . You can also scroll the mouse wheel to control the zoom in/out.



Figure 6-25 Draw Area for Digital Zoom

Step 3 Right-click the image to exit the digital zoom interface.

6.2.3 Reverse Playback of Multi-Channel

Purpose

You can play back record files of multi-channel reversely. Up to 16-ch simultaneous reverse playback is supported.

Step 1 Go to **Menu > Playback**.

Step 2 Check more than one checkboxes to select multiple channels and click to select a date on the calendar.



Figure 6-26 4-ch Synchronous Playback Interface

Step 3 Click  to play back the record files reversely.

NOTE

For 7304/8104HUHI series DVR, at least 2-ch 8 MP multi-channel playback is supported. For HUHI series DVR with 8 video inputs, at least 4-ch 8 MP multi-channel playback is supported. For HUHI series DVR with 16 video inputs, at least 8-ch 8 MP multi-channel playback is supported.

6.2.4 File Management

Purpose

You can manage the video clips, captured pictures in playback, locked files and tags you have added in the playback mode.

Step 1 Enter the playback interface.

Step 2 Click  on the toolbar to enter the file management interface.

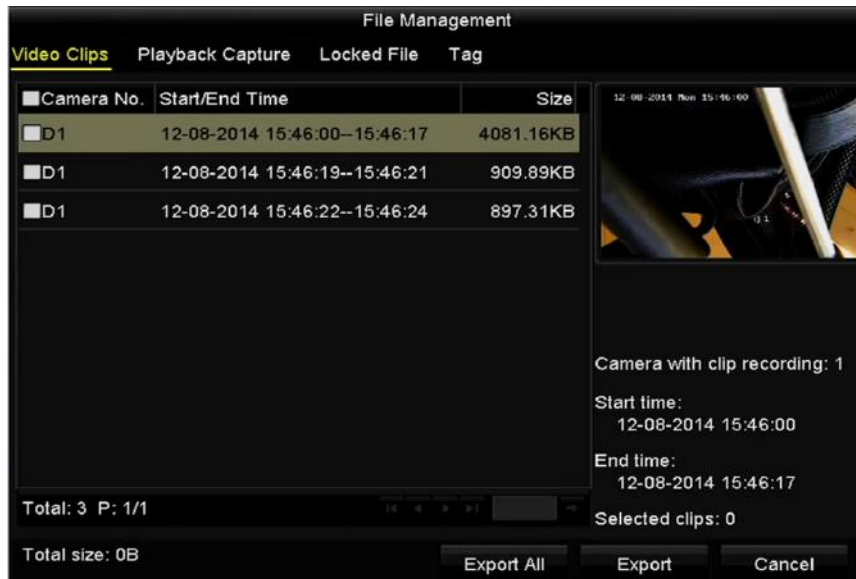

Figure 6-27 File Management

Step 3 You can view the saved video clips, captured playback pictures, lock/unlock the files and edit the tags which you added in the playback mode.

Step 4 If required, select the items and click **Export All** or **Export** to export the clips/pictures/files/tags to local storage device.

Chapter 7 Backup

7.1 Backing up Record Files

Before you start

Please insert the backup device(s) into the device.

7.1.1 Backing up by Normal Video/Picture Search

Purpose

The record files or pictures can be backed up to various devices, such as USB devices (USB flash drives, USB HDDs, USB writer), SATA writer and e-SATA HDD.

Backup using USB flash drives and USB HDDs

Step 1 Go to **Menu > Export > Normal/Picture**.

Step 2 Select the cameras to search.

Step 3 Set search condition and click **Search** to enter the search result interface.

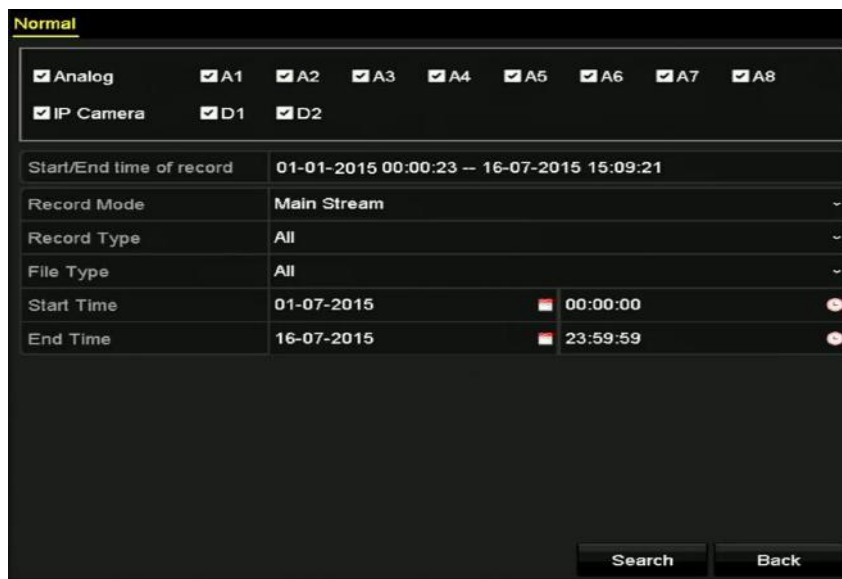

Figure 7-1 Normal Video Search for Backup

Step 4 The matched video files are displayed in **Chart** or **List** display mode.

Click  to play the record file if you want to check it.

Check the checkbox before the video files you want to back up.



NOTE

The size of the currently selected files is displayed in the lower-left corner of the window.

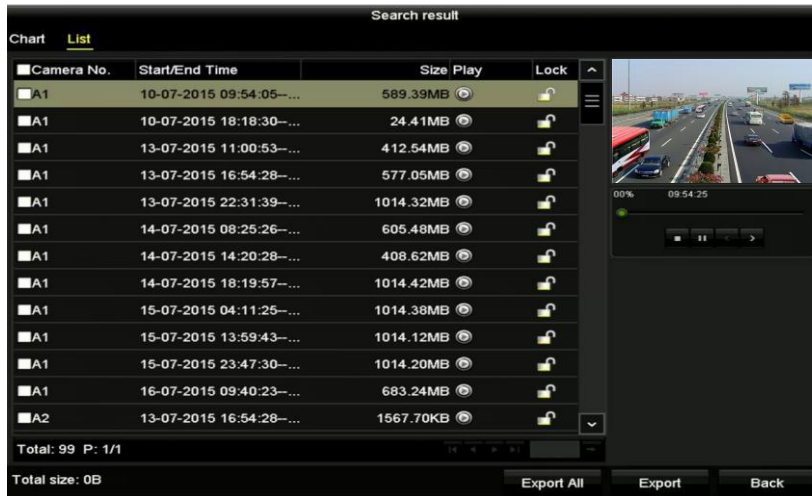

Figure 7-2 Result of Normal Video Search for Backup

Step 5 Select video files from the **Chart** or **List** to export, and click the button **Export** to enter the **Export** interface.

You can also click **Export All** to select all the video files for backup and enter the **Export** interface.



Figure 7-3 Export by Normal Video Search using USB Flash Drive

Step 6 Select the backup device from the drop-down list and you can also select the file format to filter the files existing in the backup device.

Step 7 Select the saving type.

Step 8 Click **Export** on the Export interface to start the backup process.

- 1) On the pop-up message box, click the radio button to export the video files, log or the player to the backup device.

2) Click **OK** to confirm.

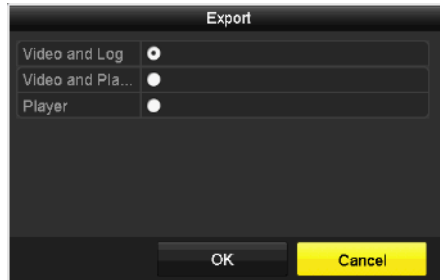

Figure 7-4 Select File or Player for Backup

Step 9 A prompt message will pop up after the backup process is complete. Click **OK** to confirm.

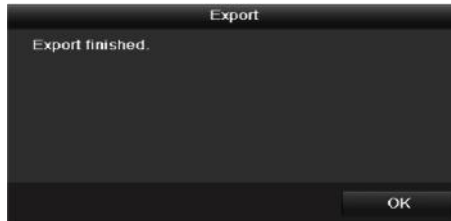

Figure 7-5 Export Finished



NOTE

The backup of pictures using USB writer or SATA writer has the same operating instructions. Please refer to steps described above.

7.1.2 Backing up by Event Search

Purpose

Back up event-related record files using USB devices (USB flash drives, USB HDDs, USB writer), SATA writer or eSATA HDD. Quick Backup and Normal Backup are supported.

Step 1 Go to **Menu > Export > Event**.

Step 2 Select the cameras to search.

Step 3 Select the event type to alarm input, motion, VCA, or POS (for DS-7300HQHI and DS-7300/9000HUHI-K series DVR).



Figure 7-6 Event Search for Backup

Step 4 Set search condition and click **Search** to enter the search result interface. The matched video files are displayed in **Chart** or **List** display mode.

Step 5 Select video files from the **Chart** or **List** interface to export.

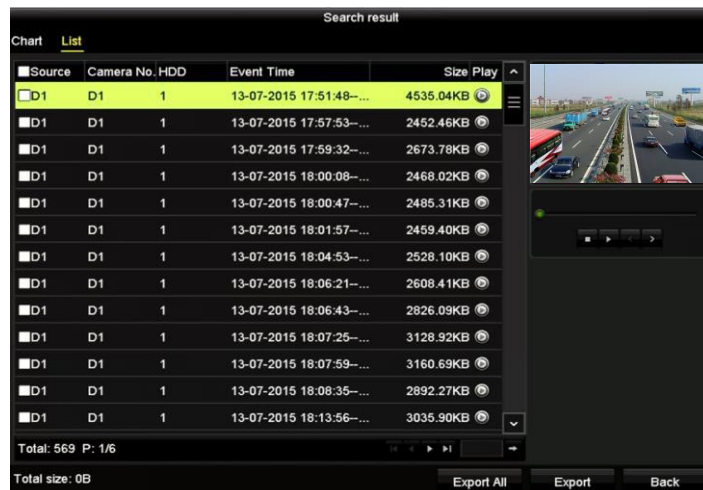

Figure 7-7 Result of Event Search



Step 6 Export the video files. Please refer to step5 of *Chapter 7.1.1 Backing up by Normal Video/Picture Search* for details.

7.1.3 Backing up Video Clips

Purpose

You may also select video clips in playback mode to export directly during Playback, using USB devices (USB flash drives, USB HDDs, USB writer), or SATA writer.

Step 1 Go to **Menu > Playback**.

Step 2 During playback, use buttons  or  in the playback toolbar to start or stop clipping record file(s).

Step 3 Click  to enter the file management interface.



Figure 7-8 Video Clips Export Interface

Step 4 Export the video clips in playback. Please refer to step5 of *Chapter 7.1.1 Backing up by Normal Video/Picture Search* for details.

7.2 Managing Backup Devices

Management of USB flash drives, USB HDDs and eSATA HDDs

Step 1 Enter the **Export** interface.



Figure 7-9 Storage Device Management

Step 2 Backup device management.

Click **New Folder** if you want to create a new folder in the backup device.

Select a record file or folder in the backup device and click  button if you want to delete it.

Click **Erase** if you want to erase the files from a re-writable CD/DVD.

Click **Format** to format the backup device.



NOTE

If the inserted storage device is not recognized:

- Click **Refresh**.
- Reconnect device.
- Check for compatibility from vendor.

Chapter 8 Alarm Settings

8.1 Setting Motion Detection

Step 1 Go to **Menu > Camera > Motion**.

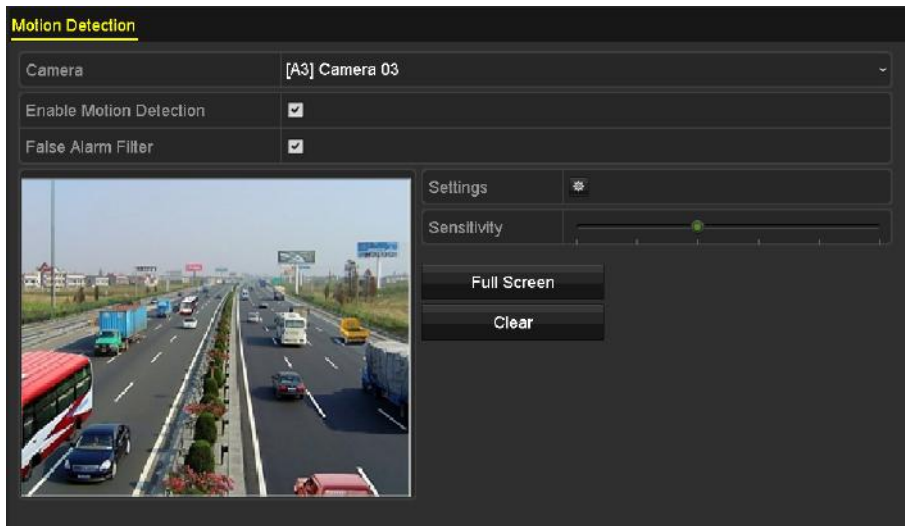

Figure 8-1 Motion Detection Setup Interface

Step 2 Select a camera you want to set up motion detection.

Step 3 Set detection area and sensitivity.

Check checkbox to enable motion detection. Use the mouse to draw detection area(s) or click **Full Screen** to set the detection area to be the full screen and drag the sensitivity bar to set sensitivity.

Click  to set alarm response actions.

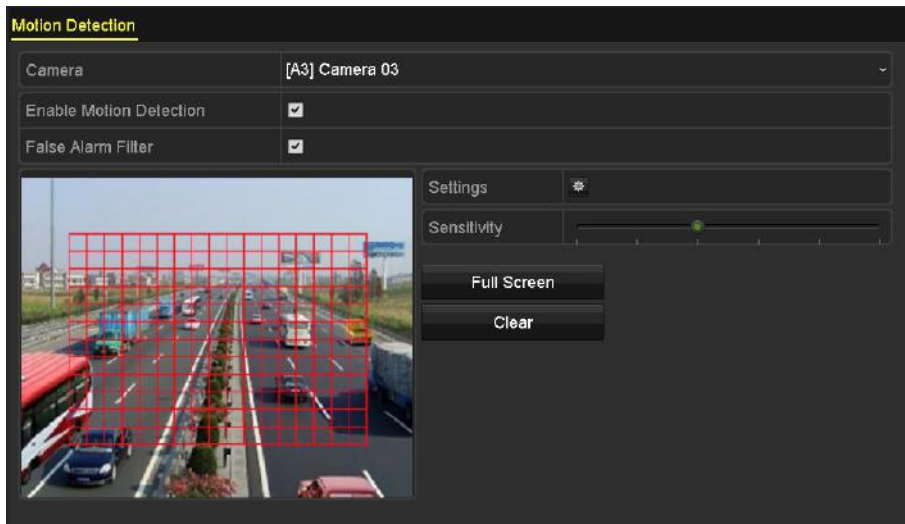

Figure 8-2 Set Detection Area and Sensitivity

Step 4 Click **Trigger Channel** and select one or more channels which will start to record or become full-screen monitoring when motion alarm is triggered.

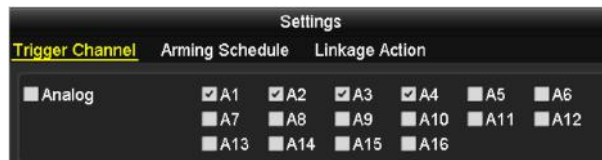

Figure 8-3 Set Trigger Camera of Motion Detection

Step 5 Set arming schedule of the channel.

Select **Arming Schedule** to set the channel's arming schedule.

Choose one day of a week and up to eight time periods can be set within each day. Or you can click **Copy** to copy the time period settings to other day(s).

 **NOTE**

Time periods shall not be repeated or overlapped.



Figure 8-4 Set Arming Schedule of Motion Detection

Step 6 Click **Linkage Action** to set up alarm response actions of motion alarm (please refer to *Chapter 8.8 Setting Alarm Response Actions*).

Repeat the above steps to set up arming schedule of other days of a week.

Click **OK** to complete the motion detection settings of the channel.

Step 7 If you want to set motion detection for another channel, repeat the above steps or just copy the above settings to it.



NOTE

You are not allowed to copy the “Trigger Channel” action.

8.2 Setting PIR Camera Alarm

Purpose

DVR can receive the PIR (Passive Infrared) alarm of the analog cameras supporting the function via coaxial communication. You can enable false alarm filter for the motion detection of the PIR cameras. Then only when the motion detection events and PIR events are both triggered, the motion detection alarm will be triggered, and the alarm indicator will light on for the PIR cameras supporting enabling alarm indicator.

Before you start

Connect the PIR camera to the DVR. Configure **White Light** as **Alarm** and **Trigger Mode** as **DVR** for the camera OSD.

Step 1 Go to **Menu > Camera > Motion**.



Figure 8-5 Motion Detection

Step 2 Select the connected PIR camera.

Step 3 Check **Enable Motion Detection**.

Step 4 Check **False Alarm Filter** to enable PIR motion detection. The message box pops up as below.

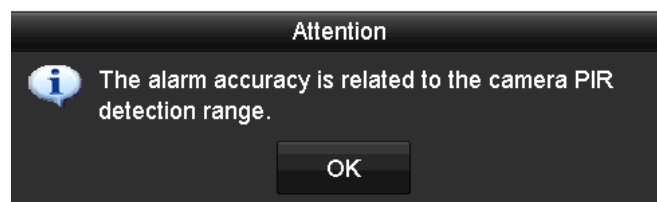



Figure 8-6 Note

Step 5 Click **OK** to enable PIR motion detection. Then only when the motion detection events and PIR events are both triggered, the motion detection alarm will be triggered.

Step 6 Set detection area and sensitivity. Refer to step 3 of *Chapter 8.1 Setting Motion Detection*.

Step 7 Click  to set motion detection alarm response actions. Refer to step 4 of *Chapter 8.1 Setting Motion Detection*.

Step 8 Click **Apply** to save the settings.



NOTE

- This function is only applicable to Hikvision PIR analog cameras.
- The PIR alarm does not support detection area configuration. It is full screen by default.
- The PIR alarm does not support sensitivity configuration.
- If you disable false alarm filter, only when the motion detection events are triggered, the motion detection alarm will be triggered. The PIR alarm will not be considered.

8.3 Setting Sensor Alarms

Purpose

Set up handling method of an external sensor alarm.

Step 9 Go to **Menu > Configuration > Alarm > Alarm Input**.



Figure 8-7 Alarm Input Settings Interface

Step 10 Set the handling method of the selected alarm input.

Check **Enable** and click  button to set its alarm response actions.

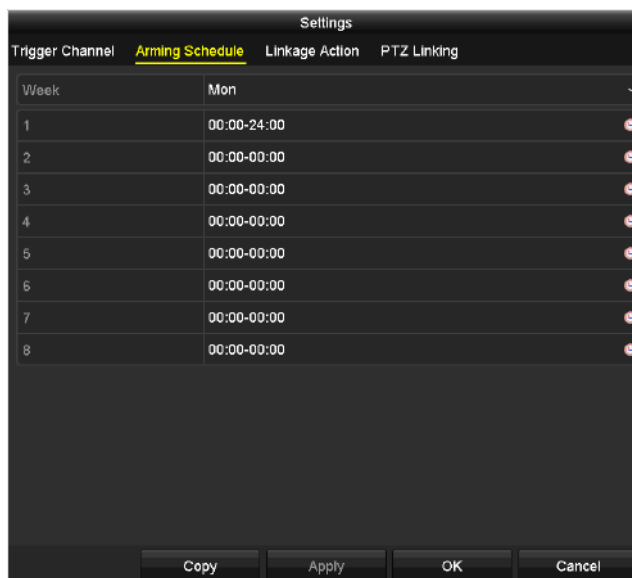

Figure 8-8 Set Arming Schedule of Alarm Input

Step 11 Select **Trigger Channel** and select one or more channels which will start to record or become full-screen monitoring when an external alarm input is triggered.

Step 12 Select **Arming Schedule** to set the channel's arming schedule.

Select one day of a week and maximum eight time periods can be set within each day.

 **NOTE**

Time periods shall not be repeated or overlapped.

Step 13 Select **Linkage Action** to set up alarm response actions of the alarm input (Refer to *Chapter 8.8 Setting Alarm Response Actions*).

Repeat the above steps to set up arming schedule of other days of a week. You can also use **Copy** to copy an arming schedule to other days.

Step 14 (Optional) Select **PTZ Linking** and set PTZ linkage of the alarm input.

Set PTZ linking parameters and click **OK** to complete the settings of the alarm input.

 **NOTE**

Check whether the PTZ or speed dome supports PTZ linkage.

One alarm input can trigger presets, patrol or pattern of more than one channel. But presets, patrols and patterns are exclusive.



Figure 8-9 Set PTZ Linking of Alarm Input

Step 15 If you want to set handling action of another alarm input, repeat the above steps or just copy the above settings to it.



Figure 8-10 Copy Settings of Alarm Input

Step 16 (Optional) Enable the one-key disarming for local alarm input 1 (Local<-1).

- 1) Check **Enable One-Key Disarming**.
- 2) Click **Settings** to enter the linkage action settings interface.
- 3) Select the alarm linkage action (s) you want to disarm for the local alarm input 1. The selected linkage actions include the Full Screen Monitoring, Audible Warning, Notify Surveillance Center, Send Email, Upload Captured Pictures to Cloud and Trigger Alarm Output.



Figure 8-11 Disarm Linkage Actions



NOTE

When the alarm input 1 (Local<-1) is enabled with one-key disarming, the other alarm input settings are not configurable.

8.4 Detecting Video Loss

Purpose

Detect video loss of a channel and take alarm response action(s).

Step 1 Go to **Menu > Camera > Video Loss**.

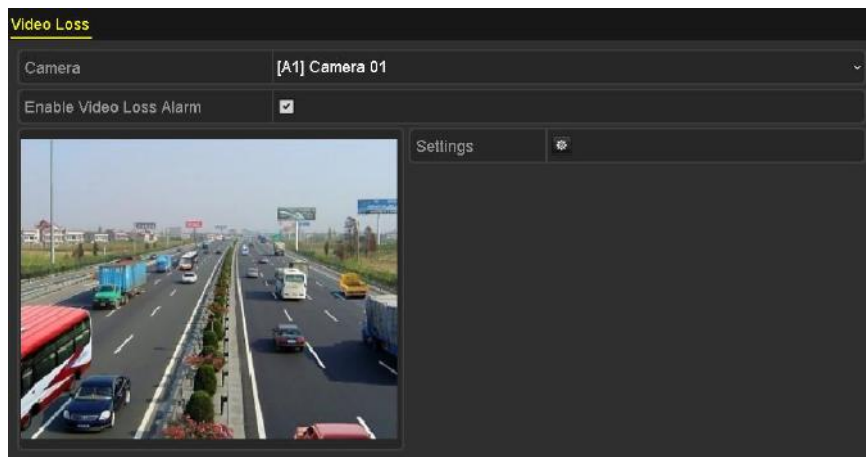



Figure 8-12 Video Loss Setup Interface

Step 2 Select a **Camera** you want to detect.

Step 3 Set up handling method of video loss.

Check **Enable Video Loss Alarm**.

Click  button to set up handling method of video loss.

Step 4 Set arming schedule of the channel.

Select **Arming Schedule** tab to set the channel's arming schedule.

Choose one day of a week and up to eight time periods can be set within each day. Or you can click **Copy** to copy the time period settings to other day(s).

 **NOTE**

Time periods shall not be repeated or overlapped.

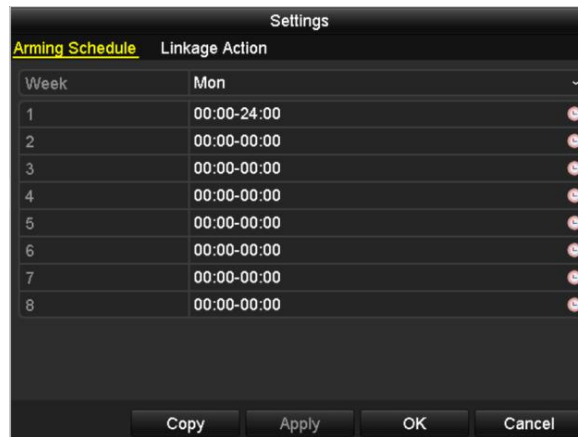

Figure 8-13 Set Arming Schedule of Video Loss

Repeat the above steps to set arming schedule of other days of a week. You can also use **Copy** to copy an arming schedule to other days.

Step 5 Select **Linkage Action** to set up alarm response action of video loss (please refer to *Chapter 8.8 Setting Alarm Response Actions*).

Step 6 Click **OK** to complete the video loss settings of the channel.

Repeat the above steps to finish settings of other channels, or click **Copy** copy the above settings to them.

8.5 Detecting Video Tampering

Purpose

Trigger alarm when the lens is covered and take alarm response action(s).

Step 1 Go to **Menu > Camera > Video Tampering Detection**.



Figure 8-14 Video Tampering Interface

Step 2 Select a **Camera** you want to detect video tampering.

Step 3 Check **Enable Video Tampering Detection**.

Step 4 Drag the sensitivity bar and choose a proper sensitivity level.

Step 5 Click  to set handling method of video tampering. Set arming schedule and alarm response actions of the channel.

- 1) Click **Arming Schedule** to set the arming schedule of response action.
- 2) Select one day of a week and up to eight time periods can be set within each day.

 **NOTE**

Time periods shall not be repeated or overlapped.

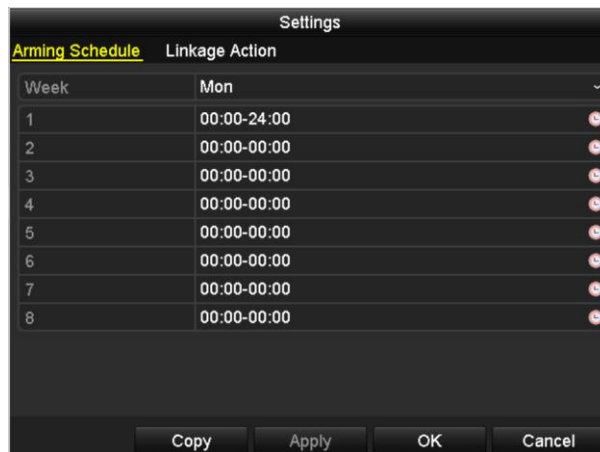

Figure 8-15 Set Arming Schedule of Video Tampering

3) Select **Linkage Action** to set alarm response actions of video tampering alarm (please refer to *Chapter 8.8 Setting Alarm Response Actions*).

Repeat the above steps to set arming schedule of other days of a week. You can also use **Copy** to copy an arming schedule to other days.

4) Click **OK** to complete the video tampering settings of the channel.

Repeat the above steps to finish settings of other channels, or click **Copy** copy the above settings to them.

Step 6 Click **Apply** to save and activate the settings.

8.6 Setting All-day Video Quality Diagnostics

Purpose

The device provides two ways to diagnose the video quality: manual and all-day. Perform the following steps to set the threshold of the diagnosing and the linkage actions.

Step 1 Go to **Menu > Camera > Video Quality Diagnostics**.

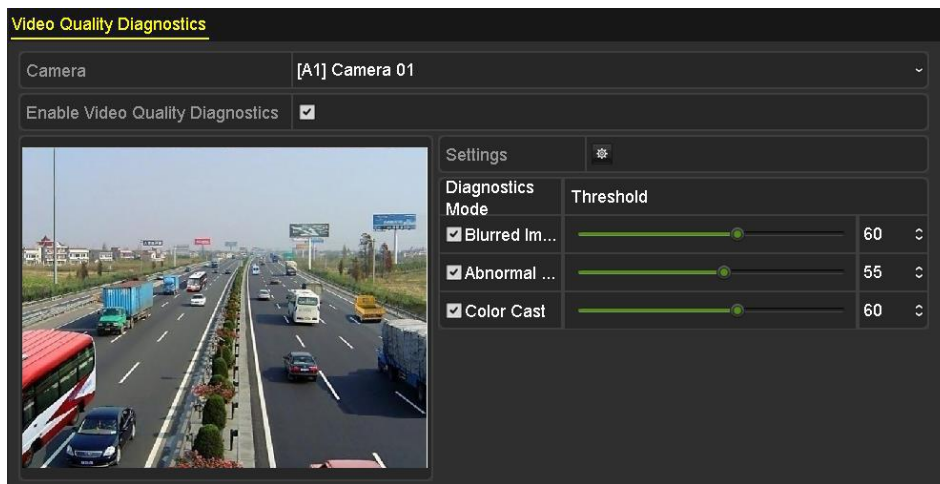

Figure 8-16 Video Quality Diagnostics Interface

Step 2 Select a **Camera** you want to detect video tampering.

Step 3 Check **Enable Video Quality Diagnostics**.



NOTE

To enable video quality diagnostics, the function should be supported by the selected camera.

Step 4 Enable and set the threshold of the diagnostic types, there are **Blurred Image**, **Abnormal Brightness**, and **Color Cast**.

Check the corresponding checkbox of the diagnostic type, and adjust the threshold of it by dragging the bar.



NOTE

The higher the threshold you set, the harder the exception will be detected.

Step 5 Click  to set handling method of video quality diagnostics. Set arming schedule and alarm response actions of the channel.

- 1) Click **Arming Schedule** to set the arming schedule of response action.
- 2) Choose one day of a week and up to eight time periods can be set within each day.

 **NOTE**

Time periods shall not be repeated or overlapped.

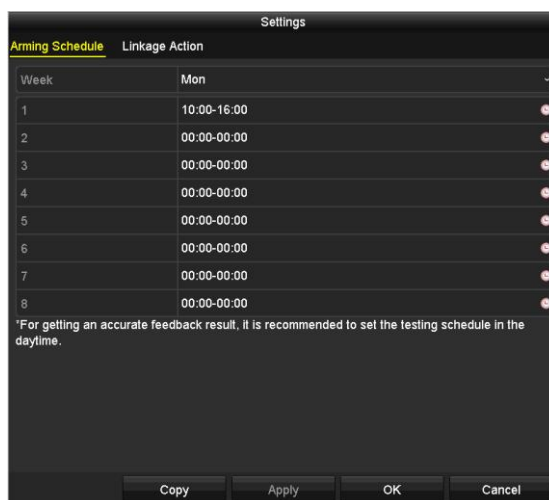

Figure 8-17 Set Arming Schedule of Video Quality Diagnostics

- 3) Select **Linkage Action** to set alarm response actions of video quality diagnostics alarm (please refer to *Chapter 8.8 Setting Alarm Response Actions*).

Repeat the above steps to set arming schedule of other days of a week. You can also use **Copy** to copy an arming schedule to other days.

- 4) Click **OK** to complete the video quality diagnostics settings of the channel.

Step 6 Click **Apply** to save and activate settings.

Step 7 (Optional) you can copy the same settings to other cameras by clicking **Copy**.

8.7 Handling Exceptions

Purpose

Exception settings refer to the handling method of various exceptions, e.g.

- **HDD Full:** The HDD is full.
- **HDD Error:** Writing HDD error, unformatted HDD, etc.
- **Network Disconnected:** Disconnected network cable.
- **IP Conflicted:** Duplicated IP address.
- **Illegal Login:** Incorrect user ID or password.

- **Input/Recording Resolution Mismatch:** The input resolution is smaller than the recording resolution.
- **Record/Capture Exception:** No space for saving recorded files or captured pictures.
- **PoC Module Exception:** The DVR cannot detect the PoC module or the PoC module is powered off abnormally.

Step 1 Go to **Menu > Configuration > Exceptions**.



Figure 8-18 Exception Settings Interface

Step 2 Check the checkbox of **Enable Event Hint** to display the (Event/Exception icon) when an exceptional event occurs. And click the icon to select the detailed event hint for display.

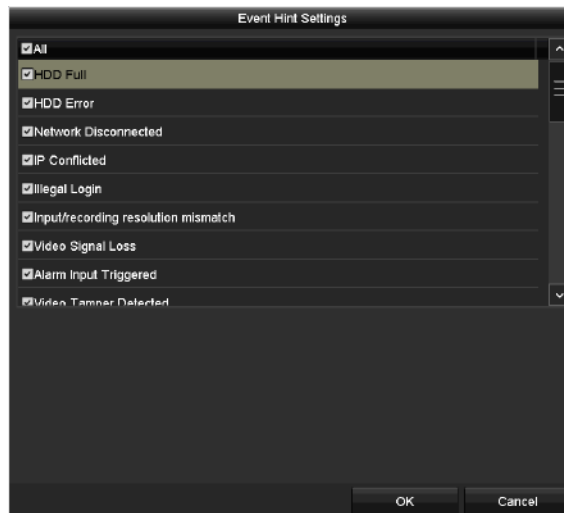

Figure 8-19 Event Hint Settings

NOTE

Click the icon appears in the live view interface, and you can view the detailed information of the exceptional event. Click **Set**, and then you can select the detailed event hint for display.

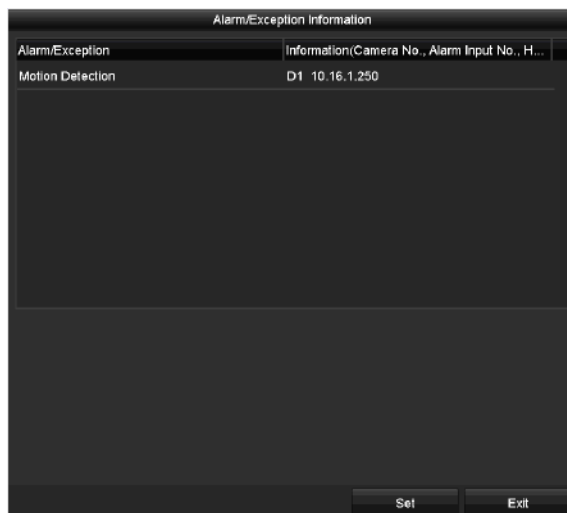

Figure 8-20 Detailed Event

Step 3 Set the alarm linkage actions. For details, see *Chapter 8.8 Setting Alarm Response Actions*.

Step 4 Click **Apply** to save the settings.

8.8 Setting Alarm Response Actions

Purpose

Alarm response actions will be activated when an alarm or exception occurs, including Full Screen Monitoring, Audible Warning (buzzer), Notify Surveillance Center, Send Email and Trigger Alarm Output.

Full Screen Monitoring

When an alarm is triggered, the local monitor (HDMI, VGA or CVBS monitor) displays in full screen the video image from the alarming channel configured for full screen monitoring.

If alarms are triggered simultaneously in several channels, their full-screen images will be switched at an interval of 10 seconds (default dwell time). A different dwell time can be set by going to Menu > Configuration > Live View.

Auto-switch will terminate once the alarm stops and you will be taken back to the Live View interface.

Audible Warning

Trigger an audible *beep* when an alarm is detected.

Notify Surveillance Center

Sends an exception or alarm signal to remote alarm host when an event occurs. The alarm host refers to the PC installed with Remote Client.

 **NOTE**

The alarm signal will be transmitted automatically at detection mode when remote alarm host is configured. Please refer to *Chapter 12.2.6 Configuring More Settings* for details of alarm host configuration.

Send Email

Send an email with alarm information to a user or users when an alarm is detected.

Please refer to *Chapter 12.2.8 Configuring Email* for details of Email configuration.

Trigger Alarm Output

Trigger an alarm output when an alarm is triggered.

Step 1 Go to **Menu > Configuration > Alarm > Alarm Output**.

Step 2 Select an alarm output and set alarm name and dwell time.

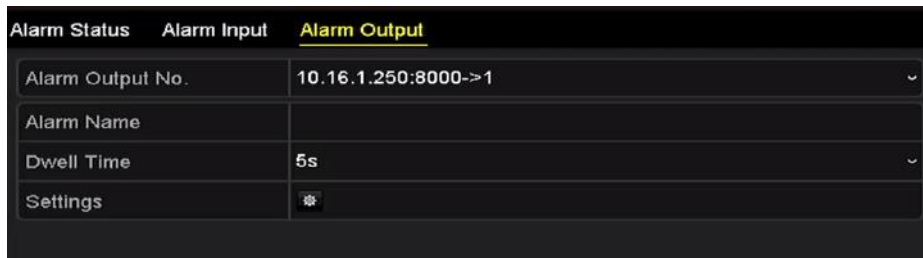



Figure 8-21 Alarm Output Settings Interface

 **NOTE**

If **Manually Clear** is selected in **Dwell Time**, you can clear it only by going to **Menu > Manual > Alarm**.

Step 3 Click  button to set the arming schedule of alarm output.

Choose one day of a week and up to 8 time periods can be set within each day.

 **NOTE**

Time periods shall not be repeated or overlapped.



Figure 8-22 Set Arming Schedule of Alarm Output

Step 4 Repeat the above steps to set arming schedule of other days of a week. You can also click **Copy** to copy an arming schedule to other days.

Click **OK** to complete the arming schedule setting of alarm output.

Step 5 Click **Apply** to save the settings.

Chapter 9 POS Configuration

NOTE

This chapter is only applicable to DS-7300HQHI-K4 and DS-7300/9000HUHI-K series DVR.

9.1 Configuring POS Settings

Step 1 Go to **Menu > Configuration > POS > POS Settings**.

Step 2 Select the POS from the drop-down list. Up to 8 POS units are selectable.

Step 3 Check the checkbox to enable the POS function.

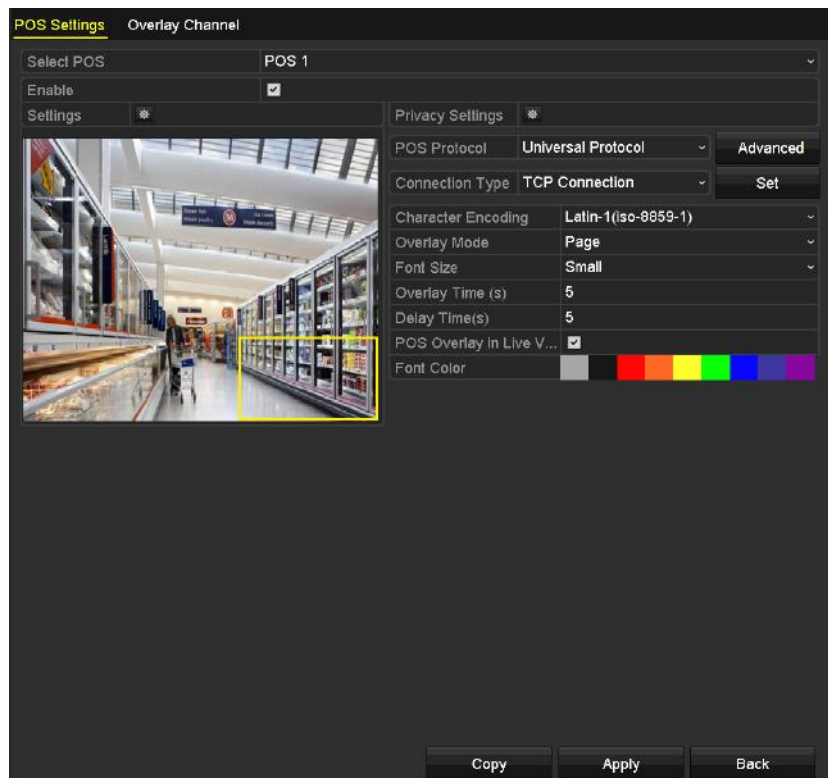

Figure 9-1 POS Settings

Step 4 Filter the POS privacy information if needed.

- 1) Click  after **Privacy Settings** to enter POS Privacy Information Filtering interface.



Figure 9-2 POS Privacy Information Filtering

- 2) Edit **Privacy Information** to hide the input information overlay. Up to 3 pieces of privacy information can be edited and no more than 32 characters can be input for each piece of information.
- 3) Click **OK** to save the settings.

Step 5 Select the POS protocol to Universal Protocol, EPSON, AVE or NUCLEUS.

● **Universal Protocol**

Click **Advanced** to expand more settings when selecting the universal protocol. You can set the start line tag, line break tag and end line tag for the POS overlay characters, and the case-sensitive property of the characters.

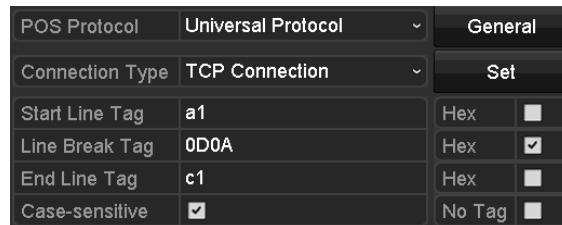

Figure 9-3 Universal Protocol Settings

● **NUCLEUS**

If you select NUCLEUS protocol, reboot the device to take the new settings into effect.

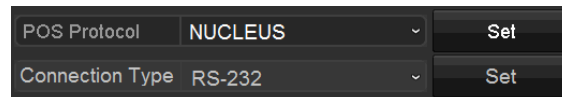

Figure 9-4 NUCLEUS Protocol Settings

- 1) Click **Set** to enter the NUCLEUS Settings interface.

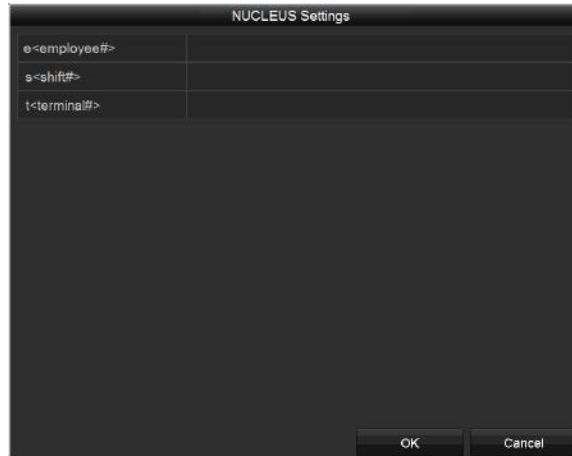

Figure 9-5 NUCLEUS Settings

- 2) Edit the Employee, Shift and Terminal information. No more than 32 characters can be input.
- 3) Click **OK** to save the settings.

 **NOTE**

- If you select NUCLEUS protocol, the connection type defaults to be RS-232, and all the other POS protocol will change to be NUCLEUS.
- You should set **Usage** to be Transparent Channel for RS-232 settings in **Menu > Configuration > RS-232** first.

Step 6 Select the Connection Type to TCP, UDP, Multicast, RS-232, USB->RS-232 or Sniff, and click **Set** to configure the parameters for each connection type.

- **TCP Connection**

When using TCP connection, the port must be set from 0 to 65535, and the port for each POS machine must be unique. Input the Allowed Remote IP Address for connecting the DVR and the POS machine via TCP.

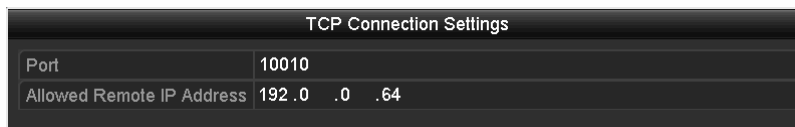

Figure 9-6 TCP Connection Settings

- **UDP Connection**

When using UDP connection, the port must be set from 0 to 65535, and the port for each POS machine must be unique. Input the Allowed Remote IP Address for connecting the DVR and the POS machine via UDP.

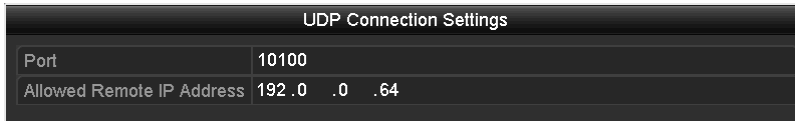

Figure 9-7 UDP Connection Settings

- **USB->RS-232 Connection**

Configure the port parameters of USB-to-RS-232 convertor, including the serial number of port, baud rate, data bit, stop bit, parity and flow ctrl.



NOTE

When using USB->RS-232 convertor mode, the port of USB-to-RS-232 convertor and the POS must be corresponding to each other, e.g., POS1 must be connected to port1 of the convertor.



Figure 9-8 USB-to-RS-232 Settings

- **RS-232 Connection**

Connect the DVR and the POS machine via RS-232. The RS-232 settings can be configured in **Menu>Configuration>RS-232**. The **Usage** must be set to Transparent Channel.



Figure 9-9 RS-232 Settings

- **Multicast Connection**

When connecting the DVR and the POS machine via Multicast protocol, set the multicast address and port.

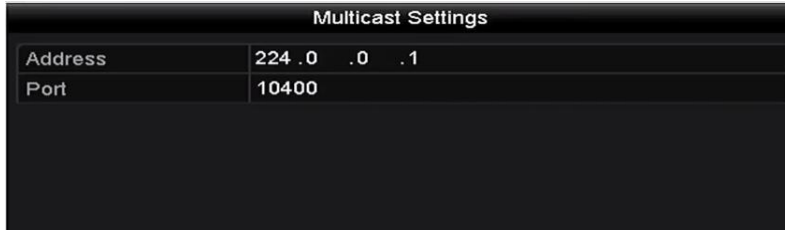

Figure 9-10 Multicast Settings

● **Sniff Connection**

Connect the DVR and the POS machine via Sniff. Configure the source address and destination address settings.

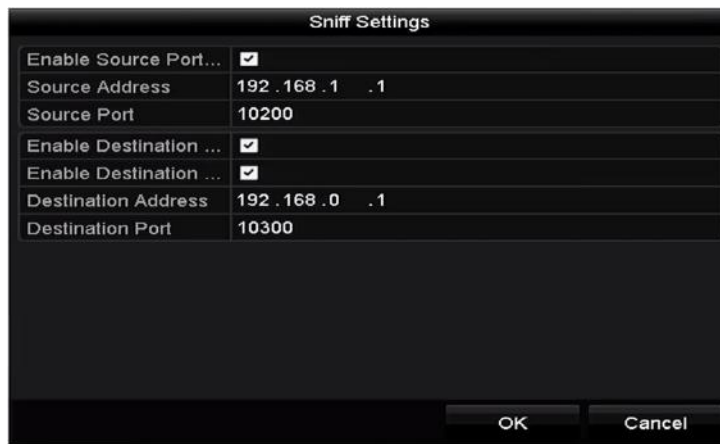

Figure 9-11 Sniff Settings

Step 7 Set other parameters of characters overly.

- 4) Select the character encoding format from the drop-down list.
- 5) Select the overlay mode of the characters to display in scrolling or page mode.
- 6) Select the font size to small, medium or large.
- 7) Set the overlay time of the characters. The value ranges from 5 to 3600 sec.
- 8) Set the delay time of the characters. The value ranges from 5 to 3600 sec.
- 9) (Optional) Check the checkbox to enable the **POS Overlay in Live View**.
- 10) Select the font color for the characters.

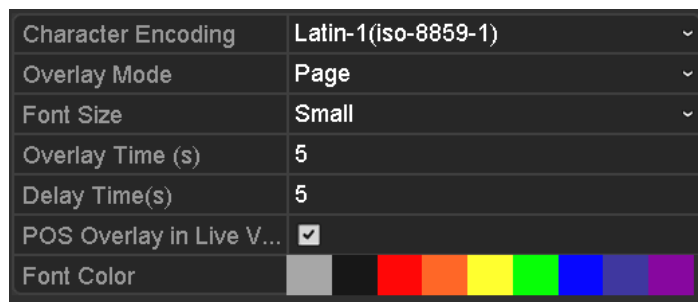

Figure 9-12 Overlay Character Settings



NOTE

You can adjust the size and position of textbox on the live view screen of POS settings interface by dragging the frame.

Step 8 Click **Apply** to activate the settings.

Step 9 (Optional) You can click **Copy** to copy the current settings to other POS (s).



Figure 9-13 Copy POS Settings

9.2 Configuring Overlay Channel

Purpose

You can assign the POS machine to corresponding channel on which you want to overlay.



Step 1 Go to **Menu > Configuration > POS > Overlay Channel**.

Step 2 Click to select an analog or IP camera from the camera list on the right, and then click a POS item from the POS list you want to overlay on the selected camera.

Click  or  to go to the previous or next page of cameras.



Figure 9-14 Overlay Channel Settings

Step 3 You can also click  to overlay all POS items to the first 8 channels in order. And the  is used to clear all POS overlay settings.

Step 4 Click **Apply** to save the settings.

9.3 Configuring POS Alarm

Purpose

Set the POS alarm parameters to trigger certain channels to start recording, or trigger full screen monitoring, audio warning, notifying the surveillance center, sending email and so on.

Step 1 Go to **Menu > Configuration > POS > POS Settings**.

Step 2 Follow the steps in Chapter 9.1-9.2 to configure the POS settings.

Step 3 Click  to enter the alarm settings interface.



Figure 9-15 Set Trigger Cameras of POS

Step 4 Click **Trigger Channel** and select one or more channels to record or become full-screen monitoring when POS alarm is triggered.

Step 5 Set arming schedule of the channel.

Select **Arming Schedule** to set the channel's arming schedule.

Choose one day of a week and up to eight time periods can be set within each day. Or you can click **Copy** to copy the time period settings to other day(s).

NOTE

Time periods shall not be repeated or overlapped.



Figure 9-16 Set Arming Schedule

Step 6 Click **Handling** to set up alarm response actions of POS alarm (Refer to *Chapter 8.8 Setting Alarm Response Actions*).

Repeat the above steps to set up arming schedule of other days of a week.

Click **OK** to complete the POS settings of the channel.

Step 7 Select **PTZ Linking** and set PTZ linkage of the POS alarm.

Set PTZ linking parameters and click **OK** to complete the settings of the alarm input.



NOTE

Please check whether the PTZ or speed dome supports PTZ linkage.

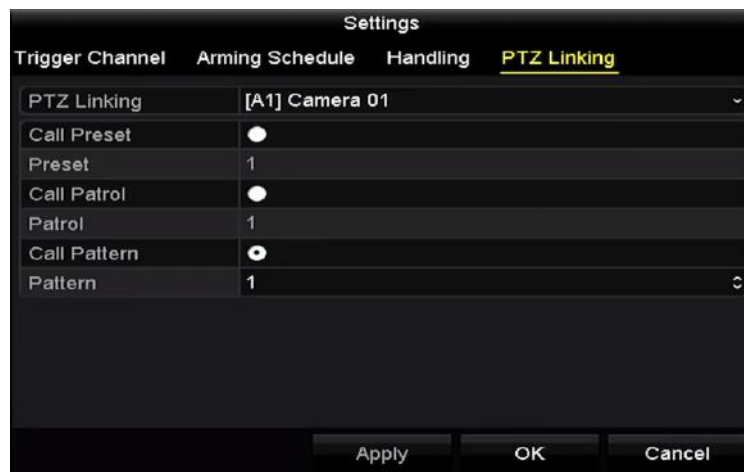

Figure 9-17 Set PTZ Linking

Step 8 Click **OK** to save the settings.

Chapter 10 VCA Alarm

Purpose

The DVR can receive the VCA alarm (line crossing detection, intrusion detection, sudden scene change detection and audio exception detection) sent by analog camera, and the VCA detection must be enabled and configured on the camera settings interface first. All other VCA detection features must be supported by the connected IP camera.



NOTE

- HTHI series DVR support full-channel line crossing detection and intrusion detection, and 2-ch sudden scene change detection. Channels with audio support audio exception detection.
- For HUHI series DVR, if enhanced VCA mode is enabled, full-channel line crossing detection and intrusion detection, and 2-ch sudden scene change detection are supported, but 2K/4K output and 4 MP/5 MP/8 MP signal input are not supported; if enhanced VCA mode is disabled, 2-ch line crossing detection and intrusion detection, and 2-ch sudden scene change detection are supported, and 2K/4K output and 4 MP/5 MP/8 MP signal input are also supported.
- DS-7200HQHI series support up to 4-ch line crossing detection and intrusion detection if enhanced VCA mode is enabled. DS-7216HQHI series also support 1-ch sudden scene change detection. Channels with audio support audio exception detection.
- DS-7300HQHI-K series support up to 4-ch line crossing detection and intrusion detection if enhanced VCA mode is enabled, and 1-ch sudden scene change detection. Channels with audio support audio exception detection.
- For the analog channels, the line crossing detection and intrusion detection conflict with other VCA detection such as sudden scene change detection, face detection and vehicle detection. You can only enable one function.
- For HUHI series DVR, the enhanced VCA mode conflicts with the 2K/4K output and 4 MP/5 MP/8 MP signal input.

10.1 Face Detection

Purpose

Face detection function detects the face appears in the surveillance scene, and some certain actions can be taken when the alarm is triggered.

Step 1 Go to **Menu > Camera > VCA**.

Step 2 Select the camera to configure the VCA.

You can check **Save VCA Picture** to save the captured pictures of VCA detection.

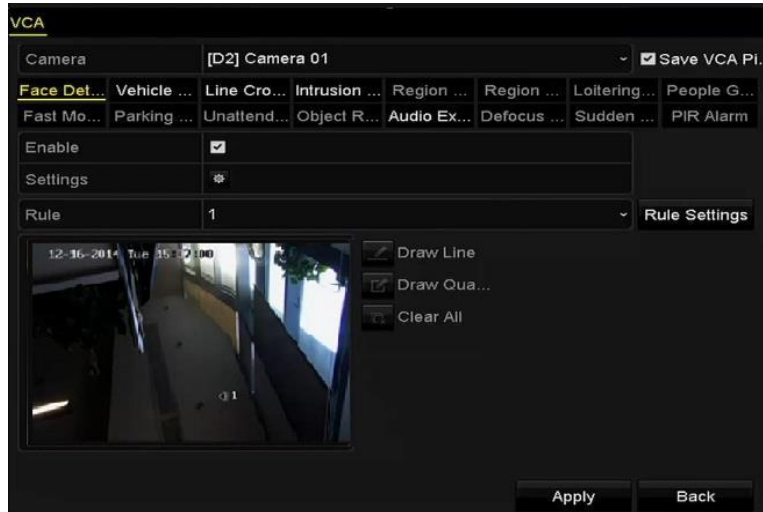

Figure 10-1 Face Detection

Step 3 Select the VCA detection type to **Face Detection**.

Step 4 Click  to enter the face detection settings interface. Configure the trigger channel, arming schedule, linkage action and PTZ linking for the face detection alarm. Please refer to step 3 to step 5 of *Chapter 8.2 Setting Sensor Alarms* for detailed instructions.



Figure 10-2 PTZ Linking

Step 5 Click **Rule Settings** to set the face detection rules. You can drag the slider to set the detection sensitivity.

Sensitivity: Range [1-5]. The higher the value is, the more easily the face can be detected.

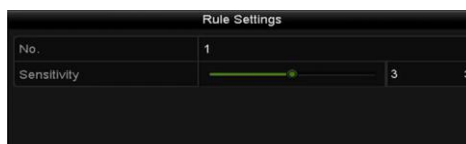

Figure 10-3 Set Face Detection Sensitivity

Step 6 Click **Apply** to activate the settings.

10.2 Vehicle Detection

Purpose

Vehicle Detection is available for the road traffic monitoring. In Vehicle Detection, the passed vehicle can be detected and the picture of its license plate can be captured. You can send alarm signal to notify the surveillance center and upload the captured picture to FTP server.

Step 1 Go to **Menu > Camera > VCA**.

Step 2 Select the camera to configure the VCA.

You can check **Save VCA Picture** to save the captured pictures of VCA detection.

Step 3 Select the VCA detection type to **Vehicle Detection**.

Step 4 Check the Enable checkbox to enable this function.

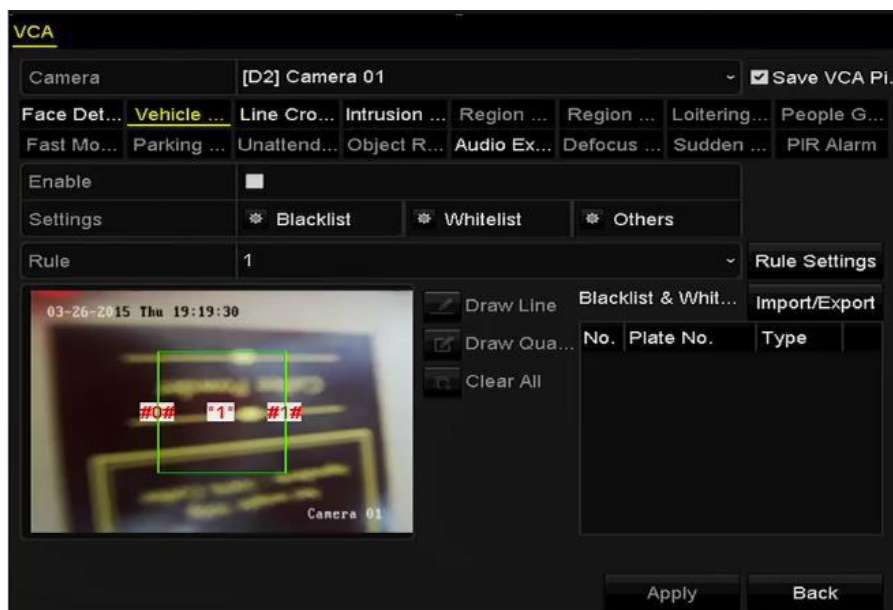



Figure 10-4 Set Vehicle Detection

Step 5 Click  to configure the trigger channel, arming schedule, linkage action and PTZ linking.

NOTE

The PTZ linking is only applicable to other list, not to whitelist and blacklist.

Step 6 Click **Rule Settings** to enter the rule settings interface. Configure the lane, upload picture and overlay content settings. Up to 4 lanes are selectable.

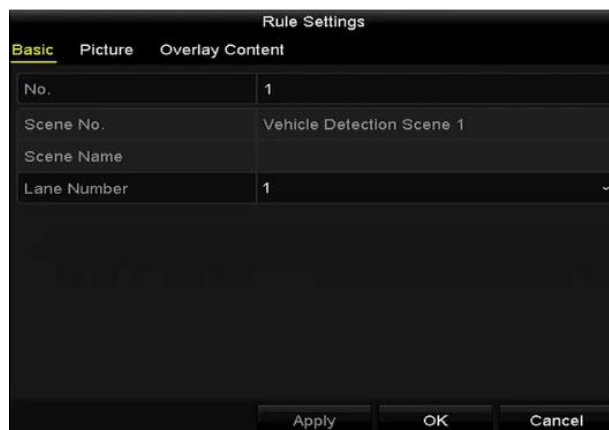

Figure 10-5 Rule Settings

Step 7 Click **Save** to save the settings.



NOTE

Refer to the User Manual of Network Camera for the detailed instructions for the vehicle detection.

10.3 Line Crossing Detection

Purpose

This function can be used for detecting people, vehicles and objects cross a set virtual line. The line crossing direction can be set as bidirectional, from left to right or from right to left. And you can set the duration for the alarm response actions, such as full screen monitoring, audible warning, etc.

Step 1 Go to **Menu > Camera > VCA**.

Step 2 Select the camera to configure the VCA.

You can check **Save VCA Picture** to save the captured pictures of VCA detection.

Step 3 Select the VCA detection type to **Line Crossing Detection**.

Step 4 Check the **Enable** checkbox to enable this function.

Step 5 Click  to configure the trigger channel, arming schedule, linkage action and PTZ linking for the line crossing detection alarm.

Step 6 Click **Rule Settings** to set the line crossing detection rules.

- 1) Select the direction to A<->B, A->B or B->A.

A<->B: Only the arrow on the B side shows. When an object goes across the configured line, both directions can be detected and alarms are triggered.

A->B: Only the object crossing the configured line from the A side to the B side can be detected.

B->A: Only the object crossing the configured line from the B side to the A side can be detected.

2) Drag the slider to set the detection sensitivity.

Sensitivity: Range [1-100]. The higher the value is, the more easily the detection alarm can be triggered.

3) Click **OK** to save the rule settings and return to the line crossing detection settings interface.



Figure 10-6 Set Line Crossing Detection Rules

Step 7 Click and set two points in the preview window to draw a virtual line.

You can use the to clear the existing virtual line and re-draw it.

NOTE

Up to 4 rules can be configured.

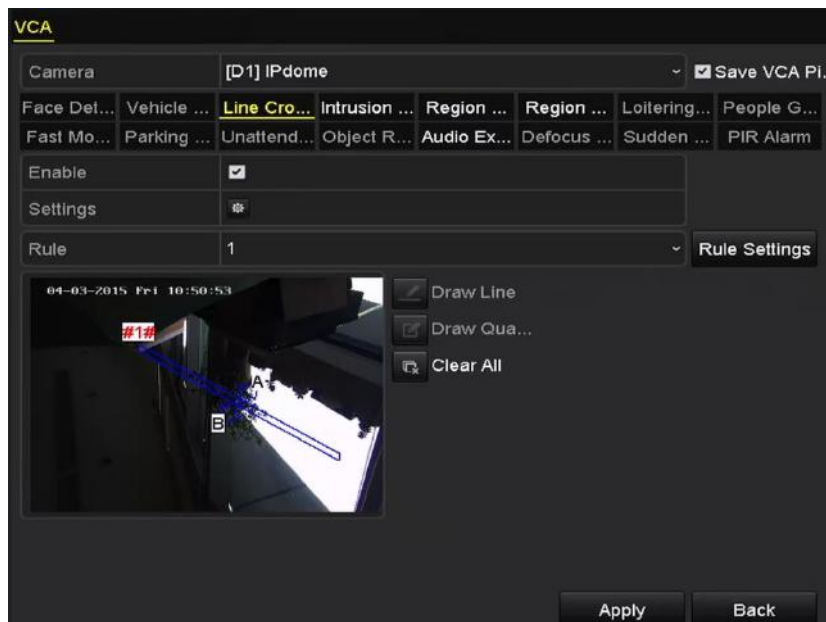

Figure 10-7 Draw Line for Line Crossing Detection

Step 8 Click **Apply** to activate the settings.

 **NOTE**

The sudden scene change detection and the line crossing detection cannot be enabled at the same channel.

10.4 Intrusion Detection

Purpose

Intrusion detection function detects people, vehicle or other objects which enter and loiter in a pre-defined virtual region, and some certain actions can be taken when the alarm is triggered.

Step 1 Go to **Menu > Camera > VCA**.

Step 2 Select the camera to configure the VCA.

You can check **Save VCA Picture** to save the captured pictures of VCA detection.

Step 3 Select the VCA detection type to **Intrusion Detection**.

Step 4 Check **Enable** to enable this function.

Step 5 Click  to configure the trigger channel, arming schedule, linkage action and PTZ linking for the intrusion detection alarm.

Step 6 Click **Rule Settings** to set the intrusion detection rules. Set the following parameters.

1) **Threshold:** Range [1s-10s], the threshold for the time of the object loitering in the region. When the duration of the object in the defined detection area is longer than the set time, the alarm will be triggered.

2) Drag the slider to set the detection sensitivity.

Sensitivity: Range [1-100]. The value of the sensitivity defines the size of the object which can trigger the alarm. The higher the value is, the more easily the detection alarm can be triggered.

3) **Percentage:** Range [1-100]. Percentage defines the ratio of the in-region part of the object which can trigger the alarm. For example, if the percentage is set as 50%, when the object enters the region and occupies half of the whole region, the alarm is triggered.



Figure 10-8 Set Intrusion Crossing Detection Rules

4) Click **OK** to save the rule settings and back to the line crossing detection settings interface.

Step 7 Click  and draw a quadrilateral in the preview window by specifying four vertexes of the detection region, and right click to complete drawing. Only one region can be configured.

You can use the  to clear the existing virtual line and re-draw it.

 **NOTE**

Up to 4 rules can be configured.

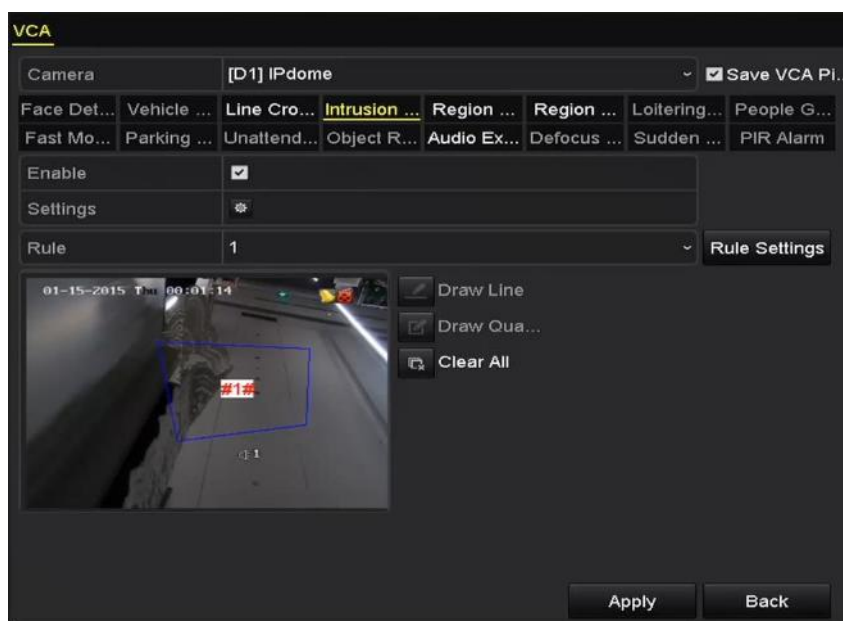

Figure 10-9 Draw Area for Intrusion Detection

Step 8 Click **Apply** to save the settings.

 **NOTE**

The sudden scene change detection and the intrusion detection cannot be enabled at the same channel.

10.5 Region Entrance Detection

Purpose

Region entrance detection function detects people, vehicle or other objects which enter a pre-defined virtual region from the outside place, and some certain actions can be taken when the alarm is triggered.

Step 1 Go to **Menu > Camera > VCA**.

Step 2 Select the camera to configure the VCA.

You can check **Save VCA Picture** to save the captured pictures of VCA detection.

Step 3 Select the VCA detection type to **Region Entrance Detection**.

Step 4 Check **Enable** to enable this function.

Step 5 Click  to configure the trigger channel, arming schedule, linkage action and PTZ linking for the region entrance detection alarm.

Step 6 Click **Rule Settings** to set the sensitivity of the region entrance detection.

Sensitivity: Range [0-100]. The higher the value is, the more easily the detection alarm can be triggered.

Step 7 Click  and draw a quadrilateral in the preview window by specifying four vertexes of the detection region, and right click to complete drawing. Only one region can be configured.

You can use the  to clear the existing virtual line and re-draw it.

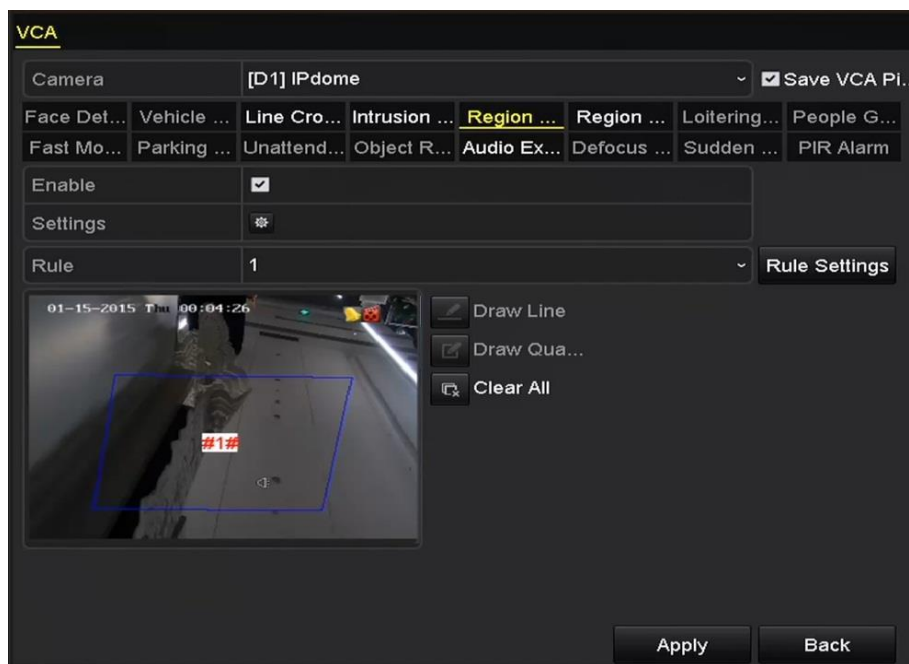

Figure 10-10 Set Region Entrance Detection

 **NOTE**

Up to 4 rules can be configured.

Step 8 Click **Apply** to save the settings.

10.6 Region Exiting Detection

Purpose

Region exiting detection function detects people, vehicle or other objects which exit from a pre-defined virtual region, and some certain actions can be taken when the alarm is triggered.

NOTE

- Please refer to the *Chapter 9.5 Region Entrance Detection* for operating steps to configure the region exiting detection.
- Up to 4 rules can be configured.

10.7 Loitering Detection

Purpose

Loitering detection function detects people, vehicle or other objects which loiter in a pre-defined virtual region for some certain time, and a series of actions can be taken when the alarm is triggered.

NOTE

- Please refer to the *Chapter 9.4 Intrusion Detection* for operating steps to configure the loitering detection.
- The **Threshold** [1s-10s] in the Rule Settings defines the time of the object loitering in the region. If you set the value as 5, alarm is triggered after the object loitering in the region for 5s; and if you set the value as 0, alarm is triggered immediately after the object entering the region.
- Up to 4 rules can be configured.

10.8 People Gathering Detection

Purpose

People gathering detection alarm is triggered when people gather around in a pre-defined virtual region, and a series of actions can be taken when the alarm is triggered.

NOTE

- Please refer to the *Chapter 9.4 Intrusion Detection* for operating steps to configure the people gathering detection.
- The **Percentage** in the Rule Settings defines the gathering density of the people in the region. Usually, when the percentage is small, the alarm can be triggered when small number of people gathered in the defined detection region.
- Up to 4 rules can be configured.

10.9 Fast Moving Detection

Purpose

Fast moving detection alarm is triggered when people, vehicle or other objects move fast in a pre-defined virtual region, and a series of actions can be taken when the alarm is triggered.

NOTE

- Please refer to the *Chapter 9.4 Intrusion Detection* for operating steps to configure the fast moving detection.
- The **Sensitivity** in the Rule Settings defines the moving speed of the object which can trigger the alarm. The higher the value is, the more easily a moving object can trigger the alarm.
- Up to 4 rules can be configured.

10.10 Parking Detection

Purpose

Parking detection function detects illegal parking in places such as highway, one-way street, etc., and a series of actions can be taken when the alarm is triggered.

NOTE

- Please refer to the *Chapter 9.4 Intrusion Detection* for operating steps to configure the parking detection.
- The **Threshold** [5s-20s] in the Rule Settings defines the time of the vehicle parking in the region. If you set the value as 10, alarm is triggered after the vehicle stay in the region for 10s.
- Up to 4 rules can be configured.

10.11 Unattended Baggage Detection

Purpose

Unattended baggage detection function detects the objects left over in the pre-defined region such as the baggage, purse, dangerous materials, etc., and a series of actions can be taken when the alarm is triggered.

NOTE

- Please refer to the *Chapter 9.4 Intrusion Detection* for operating steps to configure the unattended baggage detection.
- The **Threshold** [5s-20s] in the Rule Settings defines the time of the objects left over in the region. If you set the value as 10, alarm is triggered after the object is left and stay in the region for 10s. And the **Sensitivity** defines the similarity degree of the background image. Usually, when the sensitivity is high, a very small object left in the region can trigger the alarm.
- Up to 4 rules can be configured.

10.12 Object Removal Detection

Purpose

Object removal detection function detects the objects removed from the pre-defined region, such as the exhibits on display, and a series of actions can be taken when the alarm is triggered.



NOTE

- Please refer to the *Chapter 9.4 Intrusion Detection* for operating steps to configure the object removal detection.
- The **Threshold** [5s-20s] in the Rule Settings defines the time of the objects removed from the region. If you set the value as 10, alarm is triggered after the object disappears from the region for 10s. And the **Sensitivity** defines the similarity degree of the background image. Usually, when the sensitivity is high, a very small object taken from the region can trigger the alarm.
- Up to 4 rules can be configured.

10.13 Audio Exception Detection

Purpose

Audio exception detection function detects the abnormal sounds in the surveillance scene, such as the sudden increase/decrease of the sound intensity, and some certain actions can be taken when the alarm is triggered.



NOTE

The audio exception detection is supported by all analog channels.

Step 1 Go to **Menu > Camera > VCA**.

Step 2 Select the camera to configure the VCA.

You can check **Save VCA Picture** to save the captured pictures of VCA detection.

Step 3 Select the VCA detection type to **Audio Exception Detection**.

Step 4 Click  to configure the trigger channel, arming schedule, linkage action and PTZ linking for the audio exception alarm.

Step 5 Click **Rule Settings** to set the audio exception rules.

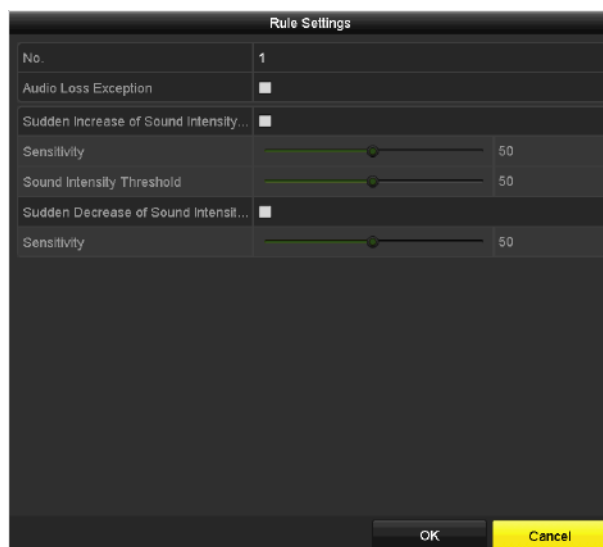

Figure 10-11 Set Audio Exception Detection Rules

- 1) Check **Audio Loss Exception** to enable the audio loss detection function.
- 2) Check **Sudden Increase of Sound Intensity Detection** to detect the sound steep rise in the surveillance scene. You can set the detection sensitivity and threshold for sound steep rise.

Sensitivity: Range [1-100], the smaller the value is, the more severe the change should be to trigger the detection.

Sound Intensity Threshold: Range [1-100], it can filter the sound in the environment, the louder the environment sound, the higher the value should be. You can adjust it according to the real environment.

- 3) Check **Sudden Decrease of Sound Intensity Detection** to detect the sound steep drop in the surveillance scene. You can set the detection sensitivity [1-100] for sound steep drop.

Step 6 Click **Apply** to activate the settings.

10.14 Defocus Detection

Purpose

The image blur caused by defocus of the lens can be detected, and some certain actions can be taken when the alarm is triggered.

NOTE

- Please refer to the *Chapter 9.1 Face Detection* for operating steps to configure the defocus detection.
- The **Sensitivity** in the Rule Settings ranges from 1 to 100, and the higher the value is, the more easily the defocus image can trigger the alarm.

10.15 Sudden Scene Change

Purpose

Scene change detection function detects the change of surveillance environment affected by the external factors; such as the intentional rotation of the camera and some certain actions can be taken when the alarm is triggered.



NOTE

- Please refer to the *Chapter 9.1 Face Detection* for operating steps to configure the scene change detection.
- The **Sensitivity** in the Rule Settings ranges from 1 to 100, and the higher the value is, the more easily the change of scene can trigger the alarm.
- For the analog cameras, the line crossing detection and intrusion detection conflict with other VCA detection such as sudden scene change detection, face detection and vehicle detection. You can only enable one function. If you have enabled line crossing detection or intrusion detection, when you enable sudden scene change detection and apply the settings, the following attention box pops up to remind you there is no enough resource and ask you to disable the enabled VCA type(s) of the selected channel(s).

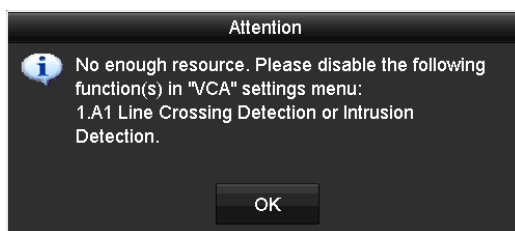

Figure 10-12 Disable Other VCA Type(s)

10.16 PIR Alarm

Purpose

A PIR (Passive Infrared) alarm is triggered when an intruder moves within the detector's field of view. The heat energy dissipated by a person, or any other warm blooded creature such as dogs, cats, etc., can be detected.

Step 1 Go to **Menu > Camera > VCA**.

Step 2 Select the camera to configure the VCA.

You can check **Save VCA Picture** to save the captured pictures of VCA detection.

Step 3 Select the VCA detection type to **PIR Alarm**.

Step 4 Click  to configure the trigger channel, arming schedule, linkage action and PTZ linking for the PIR alarm.

Step 5 Click **Rule Settings** to set the rules. Please refer to the *Chapter 9.1 Face Detection* for instructions.

Step 6 Click **Apply** to activate the settings.

Chapter 11 VCA Search

With the configured VCA detection, the device supports the VCA search for the behavior search, face search, plate search, people counting and heat map results of the IP cameras.

11.1 Face Search

Purpose

When there are detected face picture captured and saved in HDD, you can enter the **Face Search** interface to search the picture and play the picture related video files according to the specified conditions.

Before you start

Please refer to *Chapter 10.1 Face Detection* for configuring the face detection.

Step 1 Go to **Menu > VCA Search > Face Search**.

Step 2 Select the camera (s) for the face search.

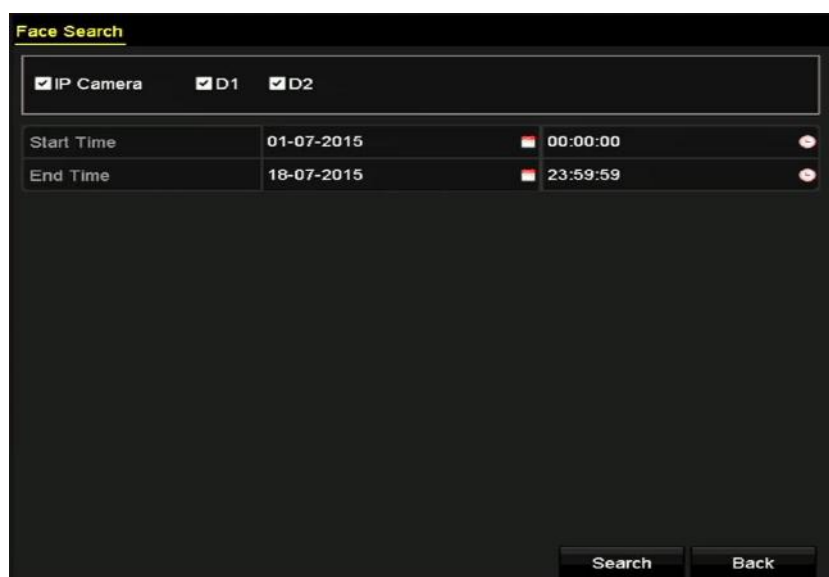

Figure 11-1 Face Search

Step 3 Specify the start time and end time for searching the captured face pictures or video files.

Step 4 Upload the pictures from your local storage device for matching the detected face pictures.

Step 5 Set the similarity level for the source pictures and the captured pictures.

Step 6 Click **Search** to start searching. The search results of face detection pictures are displayed in list or in chart.



Figure 11-2 Face Search Interface

Step 7 Play the face picture related video file.

You can double click on a face picture to play its related video file in the view window on the top right, or select a picture item and click to play it.

You can also click to stop the playing, or click / to play the previous/next file.

Step 8 If you want to export the captured face pictures to local storage device, connect the storage device to the device and click **Export All** to enter the Export interface.

Click **Export** to export all face pictures to the storage device.

Please refer to *Chapter 7 Backup* for the operation of exporting files.



Figure 11-3 Export Files

11.2 Behavior Search

Purpose

The behavior analysis detects a series of suspicious behavior based on VCA detection, and certain linkage methods will be enabled if the alarm is triggered.

Step 1 Go to **Menu > VCA Search > Behavior Search**.

Step 2 Select the camera (s) for the behavior search.

Step 3 Specify the start time and end time for searching the matched pictures.

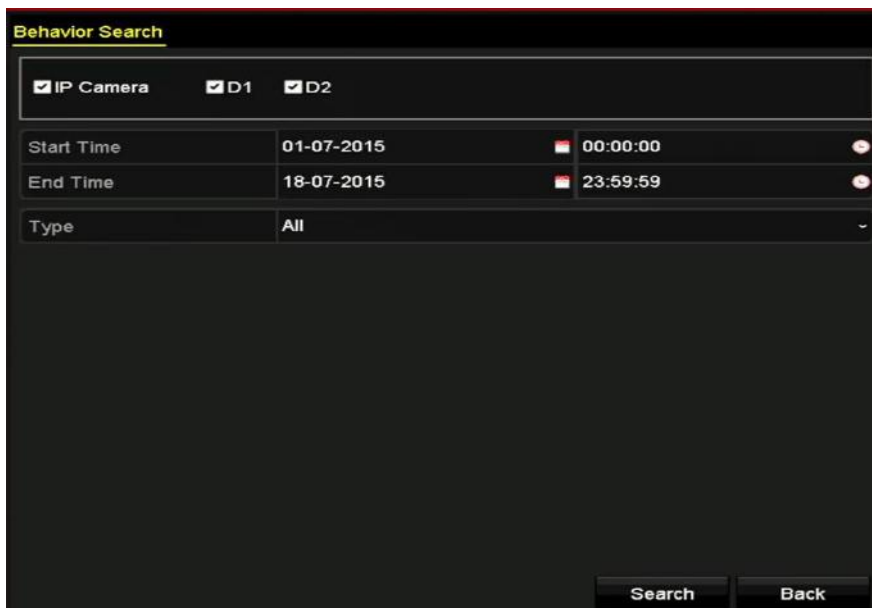

Figure 11-4 Behavior Search Interface

Step 4 Select the VCA detection type from the drop-down list, including the line crossing detection, intrusion detection, unattended baggage detection, object removal detection, region entrance detection, region exiting detection, parking detection, loitering detection, people gathering detection and fast moving detection.

Step 5 Click **Search** to start searching. The search results of pictures are displayed in list or in chart.



Figure 11-5 Behavior Search Results

Step 6 Play the behavior analysis picture related video file.

You can double click on a picture from the list to play its related video file in the view window on the top right, or select a picture item and click to play it.

You can also click to stop the playing, or click / to play the previous/next file.

Step 7 If you want to export the captured pictures to local storage device, connect the storage device to the device and click **Export All** to enter the Export interface.

Click **Export** to export all pictures to the storage device.

11.3 Plate Search

Purpose

You can search and view the matched captured vehicle plate picture and related information according to the plate searching conditions including the start time/end time, country and plate No.

Step 1 Go to **Menu > VCA Search > Plate Search**.

Step 2 Select the camera (s) for the plate search.

Step 3 Specify the start time and end time for searching the matched plate pictures.

Figure 11-6 Plate Search

Step 4 Select the country from the drop-down list for searching the location of the vehicle plate.

Step 5 Input the plate No. in the field for search.

Step 6 Click **Search** to start searching. The search results of detected vehicle plate pictures are displayed in list or in chart.



NOTE

Please refer to the Step 7 to Step 8 of *Chapter 10.1 Face Search* for the operation of the search results.

11.4 People Counting

Purpose

The People Counting is used to calculate the number of people entered or left a certain configured area and form in daily/weekly/monthly/annual reports for analysis.

Step 1 Go to **Menu > VCA Search > People Counting**.

Step 2 Select the camera for the people counting.

Step 3 Select the report type to Daily Report, Weekly Report, Monthly Report or Annual Report.

Step 4 Set the statistics time.

Step 5 Click **Counting** to start people counting statistics.



Figure 11-7 People Counting Interface

Step 6 You can click **Export** to export the statistics report in excel format.

11.5 Heat Map

Purpose

Heat map is a graphical representation of data represented by colors. The heat map function is usually used to analyze the visit times and dwell time of customers in a configured area.

Step 1 Go to **Menu > VCA Search > Heat Map**.

Step 2 Select the camera for the heat map processing.

Step 3 Select the report type to Daily Report, Weekly Report, Monthly Report or Annual Report.

Step 4 Set the statistics time.

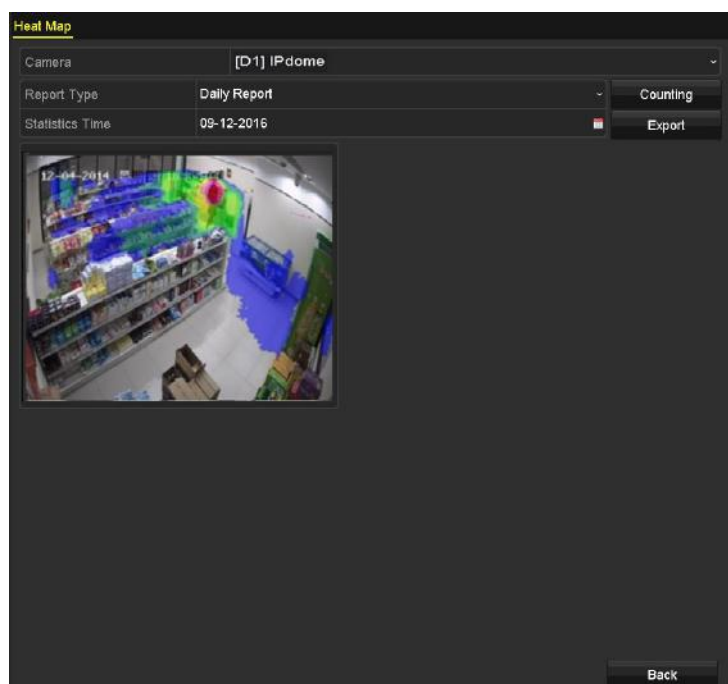

Figure 11-8 Heat Map Interface

Step 5 Click **Counting** to export the report data and start heat map statistics, and the results are displayed in graphics marked in different colors.

 **NOTE**

As shown in Figure 10-8, red color block (255, 0, 0) indicates the most welcome area, and blue color block (0, 0, 255) indicates the less-popular area.

Step 6 You can click **Export** to export the statistics report in excel format.

Chapter 12 Network Settings

12.1 Configuring General Settings

Purpose

Network settings must be properly configured before you operate DVR over network.

Step 1 Go to **Menu > Configuration > Network > General**.

NIC Type	10M/100M/1000M Self-adaptive		
Enable DHCP	<input checked="" type="checkbox"/>		
IPv4 Address	10 .16 .5 .102	IPv6 Address 1	fe80::2a57:beff:feeb:6a7f/64
IPv4 Subnet ...	255 .255 .255 .0	IPv6 Address 2	
IPv4 Default G...	10 .16 .5 .254	IPv6 Default G...	
MAC Address	28:57:be:eb:6a:7f		
MTU(Bytes)	1500		
Enable DNS DHCP	<input type="checkbox"/>		
Preferred DNS Server			
Alternate DNS Server			
Main NIC	LAN1		

Figure 12-1 Network Settings Interface

Step 2 On the **General Settings** interface, you can configure the following parameters: Working Mode (applicable for DS-7300/9000HUHI-K series), NIC Type, IPv4 Address, IPv4 Gateway, MTU, DNS Server and Main NIC.

Working Mode

There are two 10M/100M/1000M NIC cards provided by DS-7300/9000HUHI-K series DVR, and it allows the device to work in Multi-address and Net-fault Tolerance.

- **Multi-address Mode:** The parameters of the two NIC cards can be configured independently. You can select LAN1 or LAN2 in the NIC type field for parameter settings.
You can select one NIC card as default route. And then the system is connecting with the extranet and the data will be forwarded through the default route.
- **Net-fault Tolerance Mode:** The two NIC cards use the same IP address, and you can select the Main NIC to LAN1 or LAN2. By this way, in case of one NIC card failure, the device will automatically enable the other standby NIC card so as to ensure the normal running of the whole system.

NOTE

- The valid value of MTU is from 500 to 1500.
- If the DHCP server is available, you can check **Enable DHCP** to automatically obtain an IP address and other network settings from that server.

- If DHCP is enabled, you can check **Enable DNS DHCP** or uncheck it and edit the **Preferred DNS Server** and **Alternate DNS Server**.

Step 3 After having configured the general settings, click **Apply** to save the settings.

12.2 Configuring Advanced Settings

12.2.1 Configuring PPPoE Settings

Purpose

The DVR also allows access by Point-to-Point Protocol over Ethernet (PPPoE).

Step 1 Go to **Menu > Configuration > Network > PPPoE**.

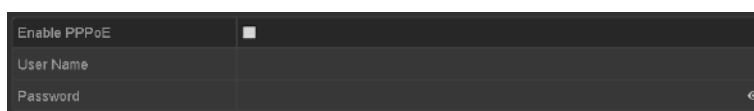

Figure 12-2 PPPoE Settings Interface

Step 2 Check **Enable PPPoE** to enable this feature.

Step 3 Enter **User Name** and **Password** for PPPoE access.



NOTE

The User Name and Password should be assigned by your ISP.

Step 4 Click **Apply** to save the settings.

Step 5 After successful settings, the system asks you to reboot the device to enable the new settings, and the PPPoE dial-up is automatically connected after reboot.

You can go to Menu > Maintenance > System Info > Network interface to view the status of PPPoE connection.

12.2.2 Configuring Hik-Connect

Purpose

Hik-Connect provides the mobile phone application and the service platform page (www.hik-connect.com) to access and manage your connected DVR, which enables you to get a convenient remote access to the surveillance system.



NOTE

The Hik-Connect can be enabled via operation on SADP software, GUI and Web browser. We introduce the operation steps on GUI in this section.

Step 1 Go to **Menu > Configuration > Network > Platform Access**.

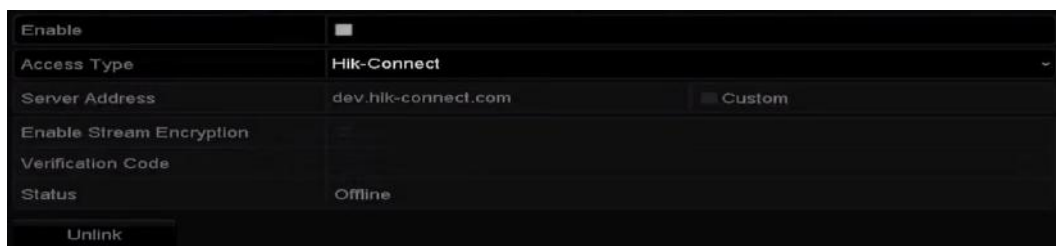

Figure 12-3 Hik-Connect Settings

Step 2 Check **Enable** to activate the function.

Then the **Service Terms** interface pops up as below.

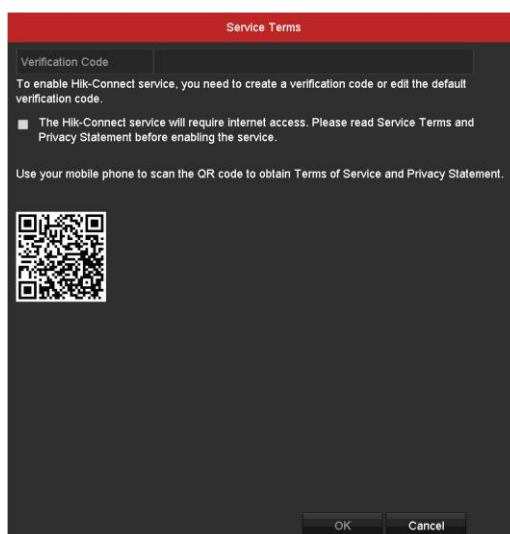

Figure 12-4 Service Terms

- 1) Create the verification code and enter the code in **Verification Code**.
- 2) Check **The Hik-Connect service will require internet access. Please read Service Terms and Privacy Statement before enabling the service.**
- 3) Scan the QR code on the interface to read the Service Terms and the Privacy Statement.
- 4) Click **OK** to save the settings and return to the Hik-Connect interface.

 **NOTE**

- Hik-Connect is disabled by default.
- The verification code is empty when the device leaves factory.
- The verification code must contain 6 to 12 letters or numbers and is case sensitive.
- Every time you enable Hik-Connect, the Service Terms interface pops up and you should check the checkbox before enabling it.

Step 3 (Optional) Check **Custom** and input the **Server Address**.

Step 4 (Optional) Check **Enable Stream Encryption**.

After this feature is enabled, the verification code is required for remote access and live view.

Step 5 (Optional) If the device is connected to Hik-Connect service user account, click **Unlink** to unlink the service.

- 1) A prompt of admin interface pops up for admin password.
- 2) Only after effective admin password has been entered, can you unlink successfully.
 - If unlinking successfully, a prompt of successful unlinking pops up.
 - If unlinking overtime, a prompt of unlinking overtime pops up.
 - If exception happens, a prompt of failed unlinking pops up.



NOTE

If the device hasn't been connected to Hik-Connect service user account, the button is grey. You can use the scanning tool of your phone to quickly get the code of the device by scanning the QR code below.



Figure 12-5 Hik-Connect Settings Interface

Step 5 Click **Apply** to save the settings.

Step 6 After configuration, you can access and manage the DVR by your mobile phone or by the website (www.hik-connect.com).

- For the iOS users, please scan the QR code below to download the Hik-Connect application for the subsequent operations.



Figure 12-6 QR Code for iOS Users

- For the Android users, please scan the QR code below to download the Hik-Connect application for the subsequent operations. You must install *googleplay* on your Android mobile phone to skip to the address successfully.



Figure 12-7 QR Code for Android Users



NOTE

Please refer to the help file on the official website (www.hik-connect.com) and the *Hik-Connect Mobile Client User Manual* for adding the device to Hik-Connect and more operation instructions.

12.2.3 Configuring DDNS

Purpose

If your DVR is set to use PPPoE as its default network connection, you may set Dynamic DNS (DDNS) to be used for network access.

Prior registration with your ISP is required before configuring the system to use DDNS.

Step 1 Go to **Menu > Configuration > Network > DDNS**.

Step 2 Check **Enable DDNS** to enable this feature.

Step 3 Select **DDNS Type**. Three different DDNS types are selectable: DynDNS, PeanutHull, and NO-IP.

- **DynDNS:**
 - 1) Enter **Server Address** for DynDNS (i.e. members.dyndns.org).
 - 2) In **Device Domain Name**, enter the domain obtained from the DynDNS website.
 - 3) Enter **User Name** and **Password** registered in the DynDNS website.

Enable DDNS	<input checked="" type="checkbox"/>
DDNS Type	DynDNS
Area/Country	Custom
Server Address	members.dyndns.org
Device Domain Name	123.dyndns.com
Status	DDNS is disabled.
User Name	test
Password	*****

Figure 12-8 DynDNS Settings Interface

- **PeanutHull:** Enter **User Name** and **Password** obtained from the PeanutHull website.

Enable DDNS	<input checked="" type="checkbox"/>
DDNS Type	PeanutHull
Area/Country	Custom
Server Address	
Device Domain Name	
Status	DDNS is disabled.
User Name	123.gcip.net
Password	*****

Figure 12-9 PeanutHull Settings Interface

- **NO-IP:**

Enter the account information in the corresponding fields. Refer to the DynDNS settings.

- 1) Enter **Server Address** for NO-IP.
- 2) In **Device Domain Name**, enter the domain obtained from the NO-IP website (www.no-ip.com).
- 3) Enter **User Name** and **Password** registered in the NO-IP website.

Enable DDNS	<input checked="" type="checkbox"/>
DDNS Type	NO-IP
Area/Country	Custom
Server Address	no-ip.org
Device Domain Name	123.no-ip.org
Status	DDNS is disabled.
User Name	test
Password	*****

Figure 12-10 NO-IP Settings Interface

Step 4 Click **Apply** to save and exit the interface.

12.2.4 Configuring NTP Server

Purpose

A Network Time Protocol (NTP) Server can be configured on your DVR to ensure the accuracy of system date/time.

Step 1 Go to **Menu > Configuration > Network > NTP**.

Enable NTP	<input checked="" type="checkbox"/>
Interval (min)	60
NTP Server	210.72.145.44
NTP Port	123

Figure 12-11 NTP Settings Interface

Step 2 Check **Enable NTP** to enable this feature.

Step 3 Configure the following NTP settings:

- **Interval:** Time interval between the two synchronizing actions with NTP server. The unit is minute.
- **NTP Server:** IP address of NTP server.
- **NTP Port:** Port of NTP server.

Step 4 Click **Apply** to save and exit the interface.



NOTE

The time synchronization interval can be set from 1 to 10080 minutes, and the default value is 60 minutes. If the DVR is connected to a public network, you should use a NTP server that has a time synchronization function, such as the server at the National Time Center (IP Address: 210.72.145.44). If the DVR is set in a more customized network, NTP software can be used to establish a NTP server used for time synchronization.

12.2.5 Configuring NAT

Purpose

Universal Plug and Play (UPnP™) can permit the device seamlessly discover the presence of other network devices on the network and establish functional network services for data sharing, communications, etc. You can use the UPnP™ function to enable the fast connection of the device to the WAN via a router without port mapping.

Before you start

If you want to enable the UPnP™ function of the device, you must enable the UPnP™ function of the router to which your device is connected. When the network working mode of the device is set as multi-address, the Default Route of the device should be in the same network segment as that of the LAN IP address of the router.

Step 1 Go to **Menu > Configuration > Network > NAT**.

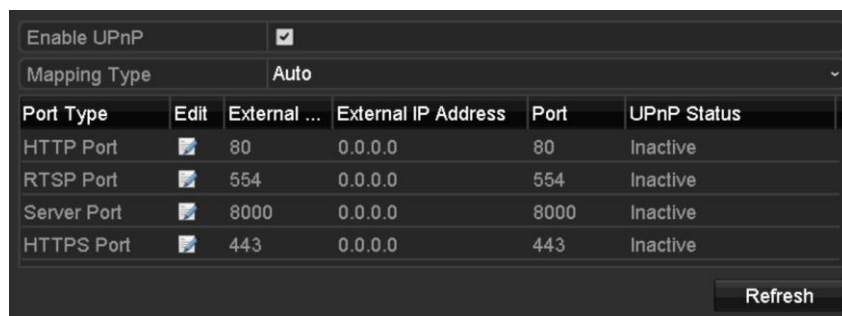

Figure 12-12 UPnP™ Settings Interface

Step 2 Check **Enable UPnP** to enable UPnP™.

Step 3 Select the **Mapping Type** as Manual or Auto in the drop-down list.

OPTION 1: Auto

If you select **Auto**, the Port Mapping items are read-only, and the external ports are set by the router automatically.

- 1) Click **Apply** to save the settings.
- 2) You can click **Refresh** to get the latest status of the port mapping.

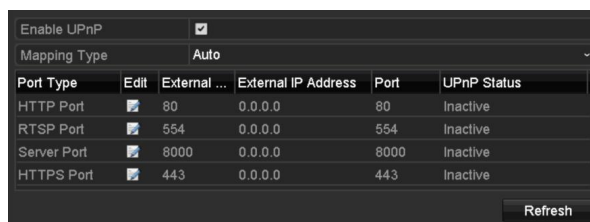

Figure 12-13 UPnP™ Settings Finished-Auto

OPTION 2: Manual

If you select **Manual** as the mapping type, you can edit the external port on your demand by clicking to activate **External Port Settings**.

- 1) Click to activate **External Port Settings**. Configure the external port No. for server port, http port and RTSP port respectively.

NOTE

- You can use the default port No., or change it according to actual requirements.
- External Port indicates the port No. for port mapping in the router.
- The value of the RTSP port No. should be 554 or between 1024 and 65535, while the value of the other ports should be between 1 and 65535 and the value must be different from each other. If multiple devices are configured for the UPnP™ settings under the same router, the value of the port No. for each device should be unique.



Figure 12-14 External Port Settings Dialog Box

- 2) Click **Apply** to save the settings.
- 3) You can click **Refresh** to get the latest status of the port mapping.

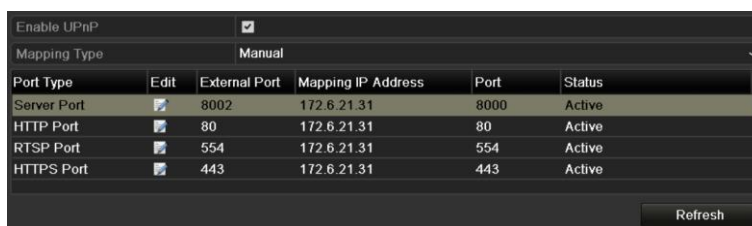

Figure 12-15 UPnP™ Settings Finished-Manual

12.2.6 Configuring More Settings

Step 1 Go to **Menu > Configuration > Network > More Settings**.

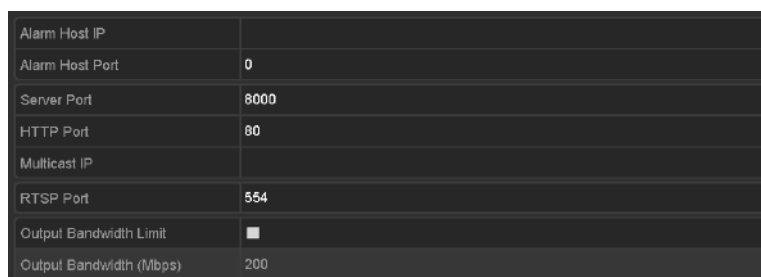

Figure 12-16 More Settings Interface

Step 2 Configure the remote alarm host, server port, HTTP port, multicast, and RTSP port.

- **Alarm Host IP/Port:** With a remote alarm host configured, the device will send the alarm event or exception message to the host when an alarm is triggered. The remote alarm host must have the CMS (Client Management System) software installed.

The **Alarm Host IP** refers to the IP address of the remote PC on which the CMS (Client Management System) software (e.g., iVMS-4200) is installed, and the **Alarm Host Port** must be the same as the alarm monitoring port configured in the software (default port is 7200).

- **Multicast IP:** The multicast can be configured to realize live view for more than the maximum number of cameras through network. A multicast address spans the Class-D IP range of 224.0.0.0 to 239.255.255.255. It is recommended to use the IP address ranging from 239.252.0.0 to 239.255.255.255.

When adding a device to the CMS (Client Management System) software, the multicast address must be the same as the device's multicast IP.

- **RTSP Port:** The RTSP (Real Time Streaming Protocol) is a network control protocol designed for use in entertainment and communications systems to control streaming media servers.

Enter the RTSP port in **RTSP Port**. The default RTSP port is 554, and you can change it according to different requirements.

- **Server Port and HTTP Port:** Enter the **Server Port** and **HTTP Port** in the text fields. The default Server Port is 8000 and the HTTP Port is 80, and you can change them according to different requirements.



NOTE

The Server Port should be set to the range of 2000-65535 and it is used for remote client software access. The HTTP port is used for remote IE access.

- **Output Bandwidth Limit:** You can check the checkbox to enable output bandwidth limit.
- **Output Bandwidth:** After enable the output bandwidth limit, input the output bandwidth in the text field.



NOTE

- The output bandwidth limit is used for the remote live view and playback.
- The default output bandwidth is the maximum limit.

Step 3 Click **Apply** to save and exit the interface.

12.2.7 Configuring HTTPS Port

Purpose

HTTPS provides authentication of the web site and associated web server that one is communicating with, which protects against Man-in-the-middle attacks. Perform the following steps to set the port number of https.

Example

If you set the port number as 443 and the IP address is 192.0.0.64, you may access the device by inputting `https://192.0.0.64:443` via the web browser.



NOTE

The HTTPS port can be only configured through the web browser.

Step 1 Open web browser, input the IP address of device, and the web server will select the language automatically according to the system language and maximize the web browser.

Step 2 Input the correct user name and password, and click **Login** to log in the device.

Step 3 Go to **Configuration > Remote Configuration > Network Settings > HTTPS**.

Step 4 Create the self-signed certificate or authorized certificate.

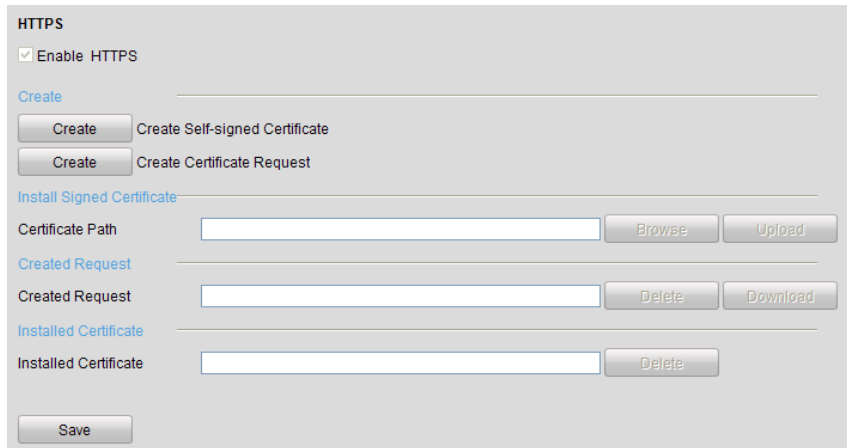

Figure 12-17 HTTPS Settings

OPTION 1: Create the self-signed certificate

1) Click **Create** to create the following dialog box.

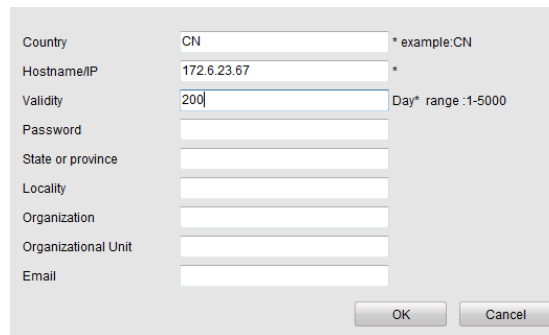

Figure 12-18 Create Self-signed Certificate

2) Enter the country, host name/IP, validity and other information.

3) Click **OK** to save the settings.

OPTION 2: Create the authorized certificate

1) Click **Create** to create the certificate request.

2) Download the certificate request and submit it to the trusted certificate authority for signature.

3) After receiving the signed valid certificate, import the certificate to the device.

Step 5 There will be the certificate information after you successfully create and install the certificate.

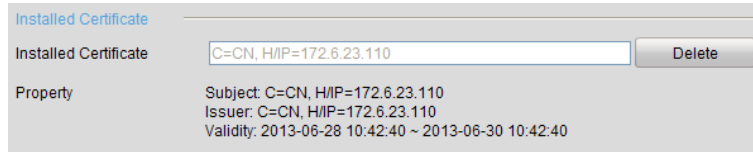

Figure 12-19 Installed Certificate Property

Step 6 Check the checkbox to enable the HTTPS function.

Step 7 Click **Save** to save the settings.

12.2.8 Configuring Email

Purpose

The system can be configured to send an Email notification to all designated users if an event is detected, e.g. an alarm or motion event is detected, etc.

Before configuring the Email settings, the DVR must be connected to a local area network (LAN) that maintains an SMTP mail server. The network must also be connected to either an intranet or the Internet depending on the location of the e-mail accounts to which you want to send notification. Additionally, the Preferred DNS server must be configured.

Before you start

Make sure you have configured the IPv4 Address, IPv4 Subnet Mask, IPv4 Gateway and the Preferred DNS Server in the Network Settings menu. Please refer to *Chapter 12.1 Configuring General Settings* for detailed information.

Step 1 Go to **Menu > Configuration > Network > Email**.

Step 2 Select **Email** to enter the **Email Settings** interface.

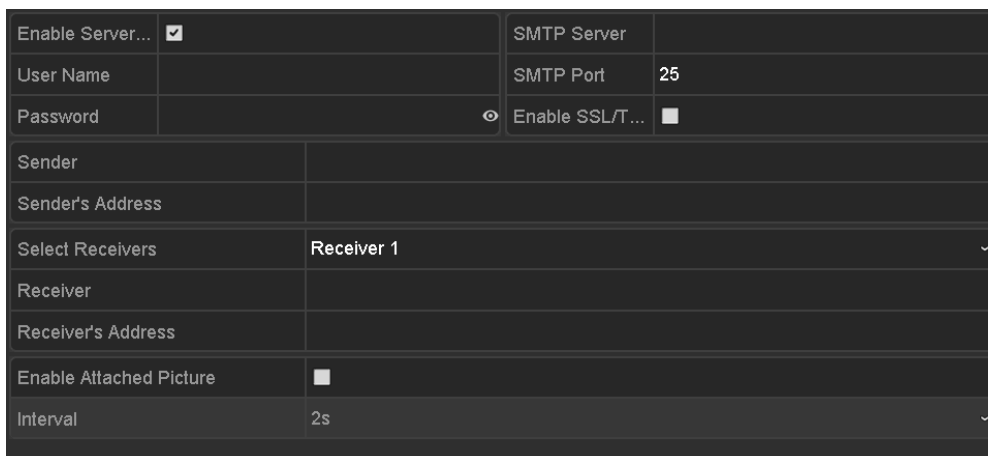

Figure 12-20 Email Settings Interface

Step 3 Configure the following Email settings:

Enable Server Authentication (optional): Check the checkbox to enable the server authentication feature.

User Name: The user account of sender's Email for SMTP server authentication.

Password: The password of sender's Email for SMTP server authentication.

SMTP Server: The SMTP Server IP address or host name (e.g., smtp.263xmail.com).

SMTP Port: The SMTP port. The default TCP/IP port used for SMTP is 25.

Enable SSL (optional): Click the checkbox to enable SSL if required by the SMTP server.

Sender: The name of sender.

Sender's Address: The Email address of sender.

Select Receivers: Select the receiver. Up to 3 receivers can be configured.

Receiver: The name of the receiver of the Email.

Receiver's Address: The Email address of the receiver.

Enable Attached Picture: Check the checkbox if you want to send email with attached alarm images. The interval is the time between two captures of the alarm images.



NOTE

- For the IP cameras, the alarm images are directly sent as the attached pictures by Email. Up to one picture can be sent for one IP camera. The attached pictures of the linked cameras cannot be sent.
- For analog cameras, 3 attached pictures can be sent for one analog camera when the alarm is triggered.

Interval: The interval refers to the time between two actions of sending attached pictures.

E-mail Test: Sends a test message to verify that the SMTP server can be reached.

Step 4 Click **Apply** to save the Email settings.

Step 5 You can click **Test** to test whether your Email settings work. The corresponding Attention message box pops up.

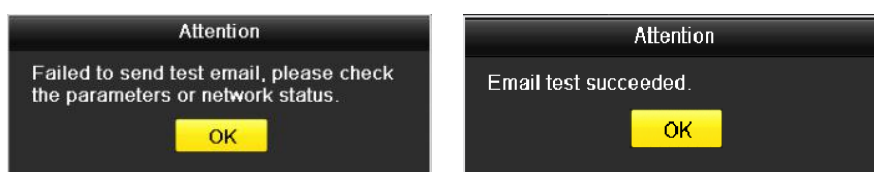

Figure 12-21 Email Testing Attention

12.2.9 Checking Network Traffic

Purpose

You can check the network traffic to obtain real-time information of DVR such as linking status, MTU, sending/receiving rate, etc.

Step 1 Go to **Menu > Maintenance > Net Detect > Traffic**.

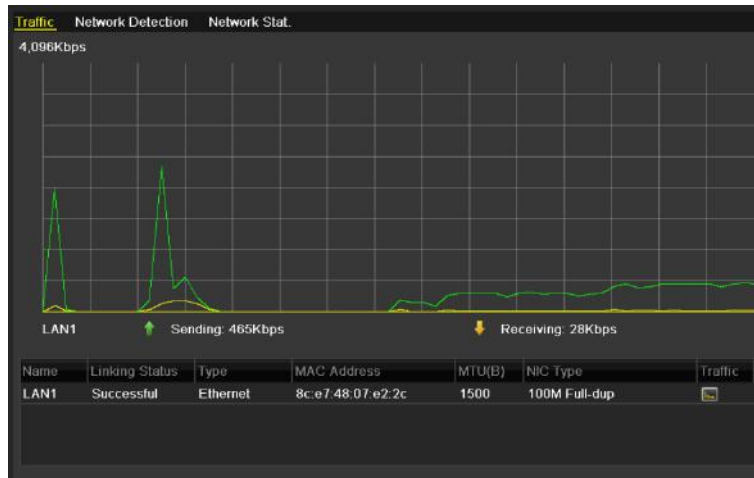

Figure 12-22 Network Traffic Interface

Step 2 You can view the sending rate and receiving rate information on the interface. The traffic data is refreshed every 1 second.

12.3 Configuring Network Detection

Purpose

You can obtain network connecting status of DVR through the network detection function, including network delay, packet loss, etc.

12.3.1 Testing Network Delay and Packet Loss

Step 1 Go to **Menu > Maintenance > Net Detect > Network Detection**.

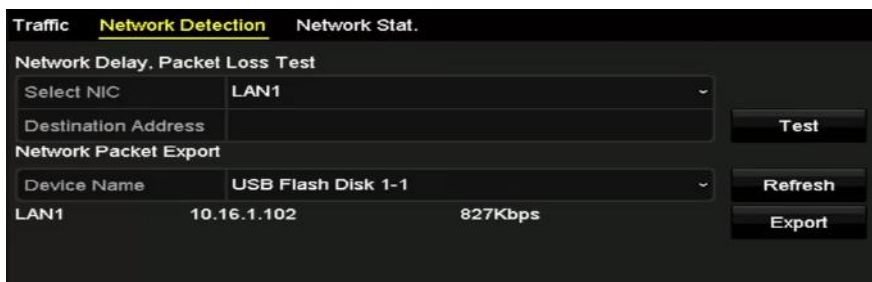

Figure 12-23 Network Detection Interface

Step 2 Select a NIC to test network delay and packet loss.

Step 3 Enter the destination address in **Destination Address**.

Step 4 Click **Test** to start testing network delay and packet loss.

12.3.2 Exporting Network Packet

Purpose

By connecting the DVR to network, the captured network data packet can be exported to USB-flash disk, SATA and other local backup devices.

Step 1 Go to **Menu > Maintenance > Net Detect > Network Detection**.

Step 2 Select the backup device from **Device Name**.



NOTE

Click **Refresh** if the connected local backup device cannot be displayed. When it fails to detect the backup device, please check whether it is compatible with the DVR. You can format the backup device if the format is incorrect.

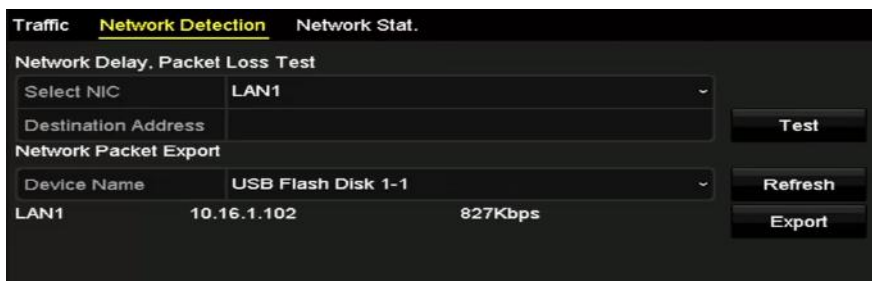

Figure 12-24 Export Network Packet

Step 3 Click **Export** to start exporting.

Step 4 After the exporting is complete, click **OK** to finish the packet export.

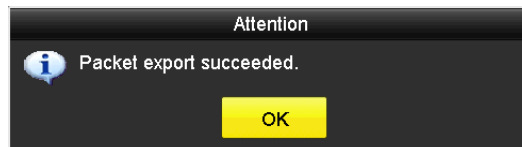

Figure 12-25 Packet Export Attention



NOTE

Up to 1M data can be exported each time.

12.3.3 Checking Network Status

Purpose

You can also check the network status and quick set the network parameters in this interface.

Step 1 Go to **Menu > Maintenance > Net Detect > Network Detection**.

Step 2 Click **Status** on the right bottom of the interface.

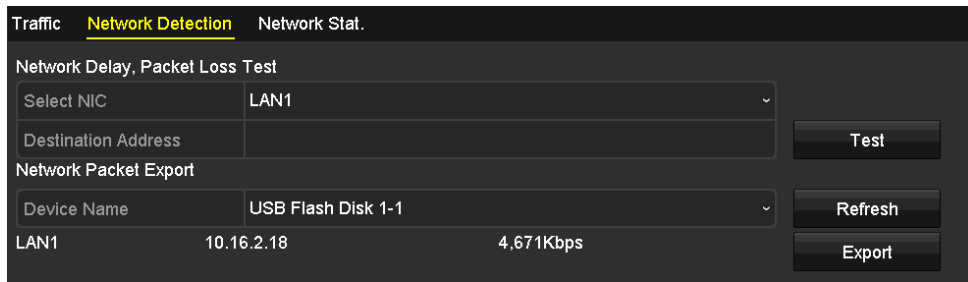

Figure 12-26 Checking Network Status

If the network is normal the following message box pops out.

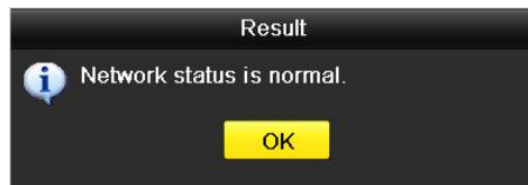

Figure 12-27 Network Status Checking Result

If the message box pops out with other information instead of this one, you can click **Network** to show the quick setting interface of the network parameters.

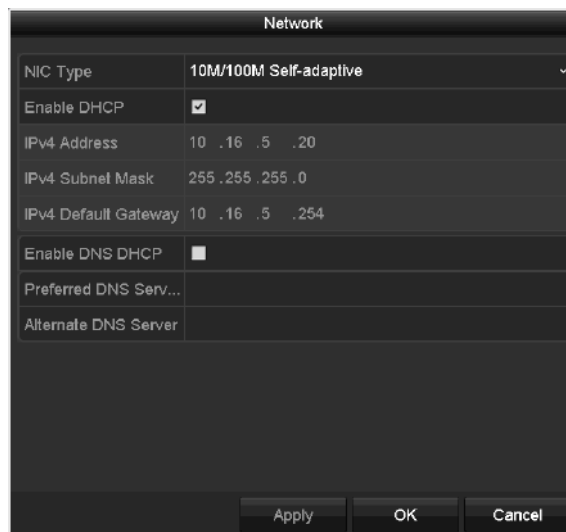

Figure 12-28 Network Parameters Configuration

12.3.4 Checking Network Statistics

Purpose:

You can check the network statistics to obtain the real-time information of the device.

Step 1 Go to **Menu > Maintenance> Net Detect > Network Stat.**

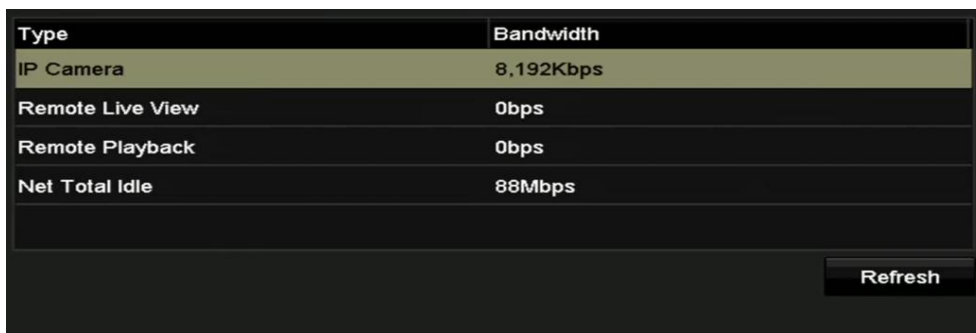

Type	Bandwidth
IP Camera	8,192Kbps
Remote Live View	0bps
Remote Playback	0bps
Net Total Idle	88Mbps

Refresh

Figure 12-29 Network Stat. Interface

Step 2 View the bandwidth of Remote Live View, bandwidth of Remote Playback, and bandwidth of Net Total Idle.

Step 3 Click **Refresh** to get the latest bandwidth statistics.

Chapter 13 RAID



NOTE

This chapter is applicable for DS-7300/9000HUHI-K series DVR.

13.1 Configuring Array

Purpose

RAID (redundant array of independent disks) is a storage technology that combines multiple disk drive components into a logical unit. A RAID setup stores data over multiple hard disk drives to provide enough redundancy so that data can be recovered if one disk fails. Data is distributed across the drives in one of several ways called "RAID levels", depending on what level of redundancy and performance is required.

The DVR supports the disk array that is realized by software. You can enable the RAID function on your demand.



NOTE

The DS-7300/8100/9000HUHI-F/N series DVR support the RAID0, RAID1, RAID5, RAID6 and RAID 10 array types.

Before you start

Please install the HDD(s) properly and it is recommended to use the same enterprise-level HDDs (including model and capacity) for array creation and configuration so as to maintain reliable and stable running of the disks.

Introduction

The DVR can store the data (such as record, picture, log information) in the HDD only after you have created the array or you have configured network HDD (refer to *Chapter14.2 Managing Network HDD*). Our device provides two ways for creating array, including one-touch configuration and manual configuration. The following flow chart shows the process of creating array.

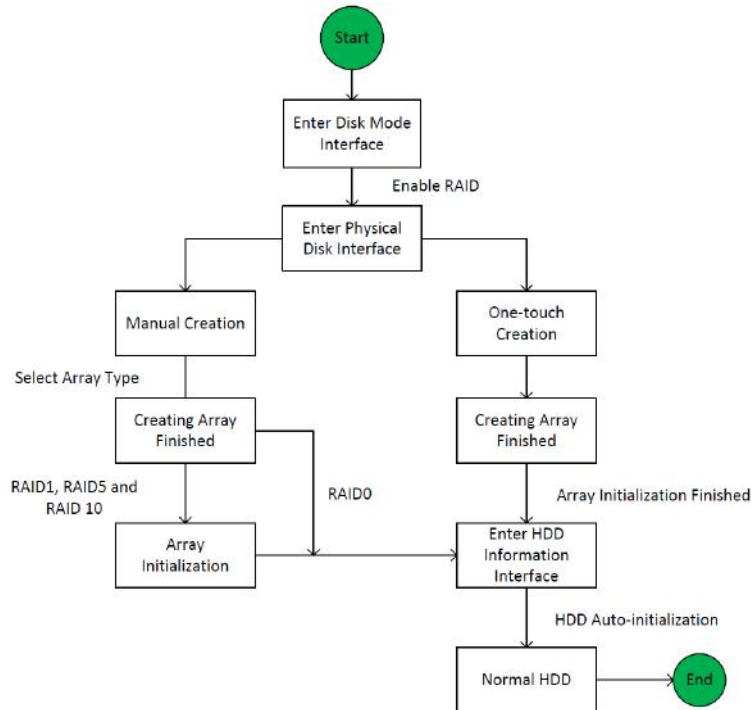

Figure 13-1 RAID Working Flow

13.1.2 Enable RAID

Purpose

Perform the following steps to enable the RAID function, or the disk array cannot be created.

- **OPTION 1:**

Enable the RAID function in the Wizard when the device startup, please refer to step 7 of Chapter 2.3.2.

- **OPTION 2:**

Enable the RAID function in the HDD Management Interface.

Step 1 Enter the Disk Mode configuration interface.

Menu > HDD > Advanced

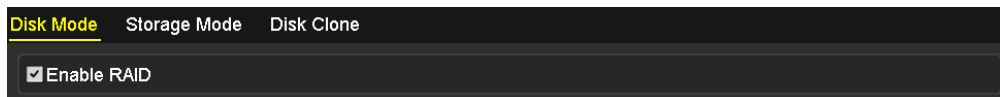

Figure 13-2 Enable RAID Interface

Step 2 Check **Enable RAID**.

Step 3 Click **Apply** to save the settings.

Step 4 Reboot the device to take RAID into effect.

13.1.3 One-touch Configuration

Purpose

Through one-touch configuration, you can quickly create the disk array. By default, the array type to be created is RAID 5.

Before you start

1. The RAID function should be enabled, please refer to the Chapter 13.1.1 for details.
2. As the default array type is RAID 5, please install at least 3 HDDs in you device.
3. If more than 10 HDDs are installed, 2 arrays can be configured.

Step 1 Enter the RAID configuration interface.

Menu > HDD > RAID

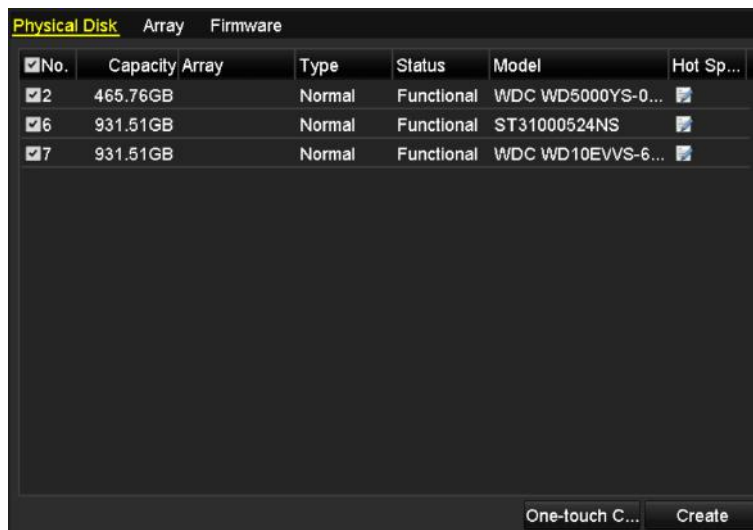

Figure 13-3 Physical Disk Interface

Step 2 Check the checkbox of corresponding HDD No. to select it.

Step 3 Click **One-touch Config** to enter the One-touch Array Configuration interface.



Figure 13-4 One-touch Array Configuration

Step 4 Edit the array name in **Array Name** and click **OK** to start configuring array.



If you install 4 HDDs or above for one-touch configuration, a hot spare disk will be set by default. It is recommended to set hot spare disk for automatically rebuilding the array when the array is abnormal.

Step 5 When the array configuration is completed, click **OK** in the pop-up message box to finish the settings.

Step 6 You can click **Array** to view the information of the successfully created array.



By default, one-touch configuration creates an array and a virtual disk.

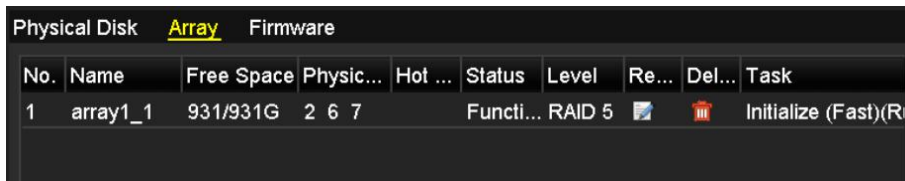

Figure 13-5 Array Settings Interface

Step 7 A created array displays as an HDD in the HDD information interface.

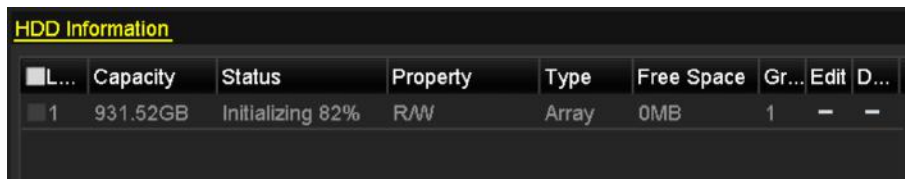

Figure 13-6 HDD Information Interface

13.1.4 Manually Creating Array

Purpose

You can manually create the array of RAID 0, RAID 1, RAID 5, RAID6 and RAID 10.



In this chapter, we take RAID 5 as an example to describe the manual configuration of array and virtual disk.

Step 1 Enter the Physical Disk Settings interface.

Menu > HDD > RAID > Physical Disk

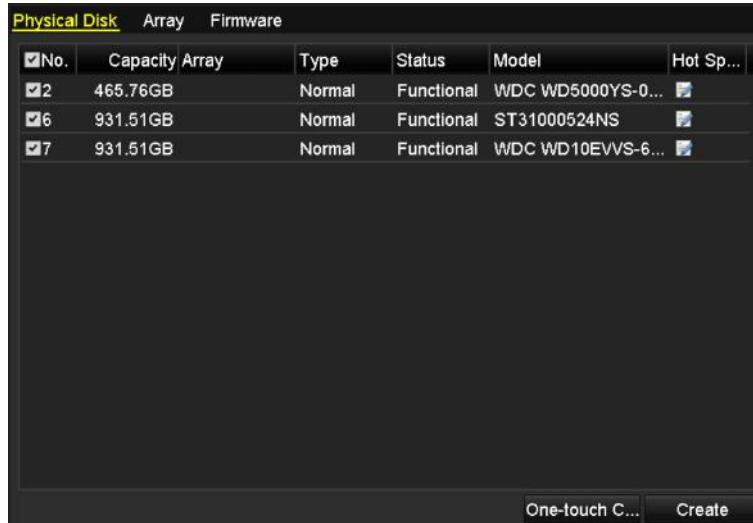

Figure 13-7 Physical Disk Settings Interface

Step 2 Click **Create** to enter the Create Array interface.

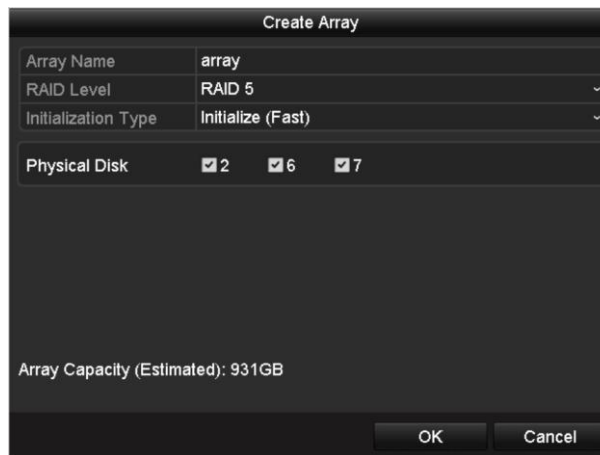

Figure 13-8 Create Array Interface

Step 3 Edit **Array Name**; set **RAID Level** to RAID 0, RAID 1, RAID 5, RAID6 or RAID 10; select the **Physical Disk** that you want to configure array.

NOTE

- If you choose RAID 0, at least 2 HDDs must be installed.
- If you choose RAID 1, 2 HDDs need to be configured for RAID 1.
- If you choose RAID 5, at least 3 HDDs must be installed.
- If you choose RAID 6, at least 4 HDDs must be installed.
- If you choose RAID 10, the number of HDDs installed should be even in the range of 4 to 16.

Step 4 Click **OK** to create array.

NOTE

If the number of HDDs you select is not compatible with the requirement of the RAID level, the error message box will pop up.



Figure 13-9 Error Message Box

Step 5 You can click **Array** to view the successfully created array.

Physical Disk <u>Array</u> Firmware									
No.	Name	Free Space	Physic...	Hot ...	Status	Level	Re...	Del...	Task
1	array1_1	931/931G	2 6 7		Funci...	RAID 5			Initialize (Fast)(R

Figure 13-10 Array Settings Interface

13.2 Rebuilding Array

Purpose

The working status of array includes Functional, Degraded and Offline. By viewing the array status, you can take immediate and proper maintenance for the disks so as to ensure the high security and reliability of the data stored in the disk array.

When there is no disk loss in the array, the working status of array will change to Functional; when the number of lost disks has exceeded the limit, the working status of array will change to Offline; in other conditions, the working status is Degraded.

When the virtual disk is in Degraded status, you can restore it to Functional by array rebuilding.

Before you start

Please make sure the hot spare disk is configured.

Step 1 Enter the Physical Disk Settings interface to configure the hot spare disk.

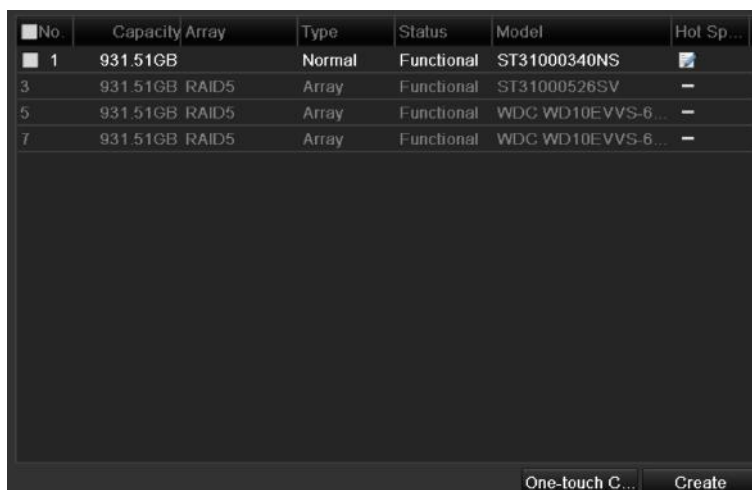

Figure 13-11 Physical Disk Settings Interface

Step 2 Select a disk and click to set it as the hot spare disk.



NOTE

Only global hot spare mode is supported.

13.2.2 Automatically Rebuilding Array

Purpose

When the virtual disk is in Degraded status, the device can start rebuilding the array automatically with the hot spare disk to ensure the high security and reliability of the data.

Step 1 Enter the Array Settings interface. The status of the array is Degraded. Since the hot spare disk is configured, the system will automatically start rebuilding using it.

Menu > HDD > RAID > Array



Figure 13-12 Array Settings Interface

If there is no hot spare disk after rebuilding, it is recommended to install a HDD into the device and set is as a hot spare disk to ensure the high security and reliability of the array.

13.2.3 Manually Rebuilding Array

Purpose

If the hot spare disk has not been configured, you can rebuild the array manually to restore the array when the virtual disk is in Degraded status.

Step 1 Enter the Array Settings interface. The disk 3 is lost.

Menu > HDD > RAID > Array

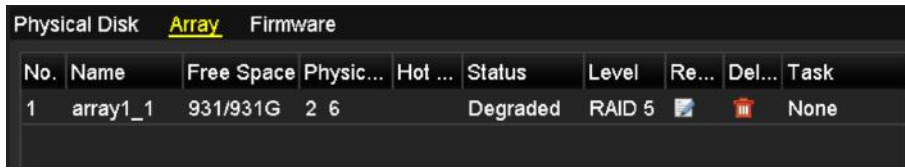



Figure 13-13 Array Settings Interface

Step 2 Click Array tab to return to the Array Settings interface and click  to configure the array rebuild.



At least one available physical disk should exist for rebuilding the array.

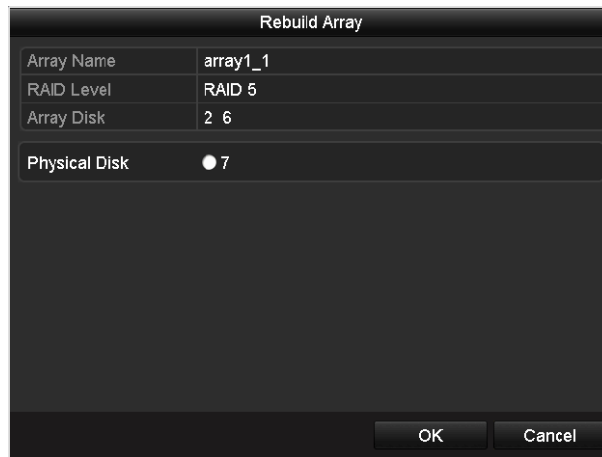

Figure 13-14 Rebuild Array Interface

Step 3 Select the available physical disk and click **OK** to confirm to rebuild the array.

Step 4 The “Do not unplug the physical disk when it is under rebuilding” message box pops up. Click **OK** to start rebuilding.

Step 5 You can enter the Array Settings interface to view the rebuilding status.

Step 6 After rebuilding successfully, the array and virtual disk will restore to Functional.

13.3 Deleting Array



Deleting array will cause to delete all the data saved in the disk.

Step 1 Enter the Array Settings interface.

Menu>HDD>RAID>Array



Figure 13-15 Array Settings Interface

Step 2 Select an array and click to delete the array.



Figure 13-16 Confirm Array Deletion

Step 3 In the pop-up message box, click **Yes** to confirm the array deletion.



NOTE

Deleting array will cause to delete all the data in the array.

13.4 Checking and Editing Firmware

Purpose

You can view the information of the firmware and set the background task speed on the Firmware interface.

Step 1 Enter the Firmware interface to check the information of the firmware, including the version, maximum physical disk quantity, maximum array quantity, auto-rebuild status, etc.

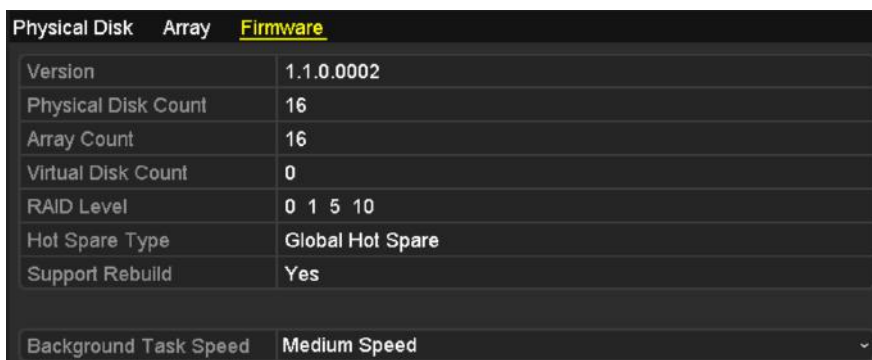

Figure 13-17 Firmware Interface

Step 2 You can set **Background Task Speed** in the drop-down list.

Step 3 Click **Apply** to save the settings.

Chapter 14 HDD Management

14.1 Initializing HDDs

Purpose

A newly installed hard disk drive (HDD) must be initialized before it can be used with your DVR.

Step 1 Go to **Menu > HDD > General**.

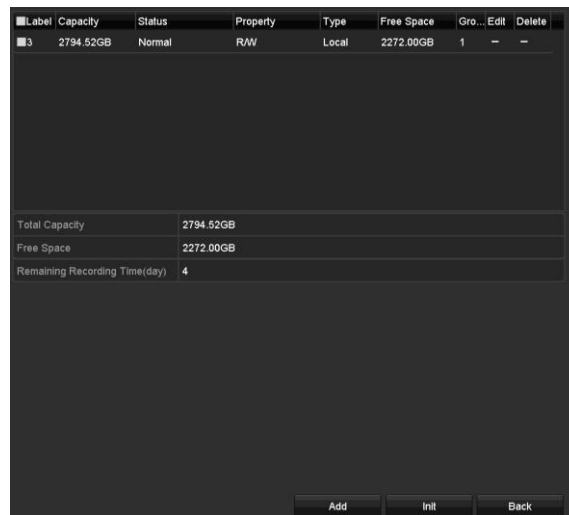

Figure 14-1 HDD Information Interface

You can view the Total Capacity, Free Space and Remaining Recording Time of the HDD. The algorithm of the Remaining Recording Time is to use average bit rate for the channel enabling smart encoding to raise accuracy.

Step 2 Select HDD to be initialized.

Step 3 Click **Init**.

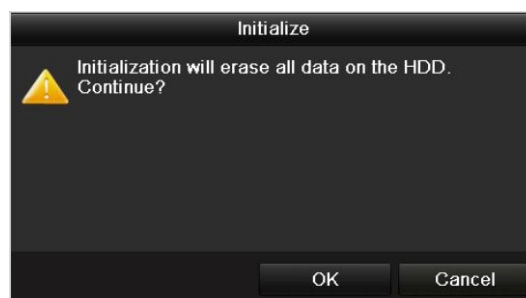

Figure 14-2 Confirm Initialization

Step 4 Select **OK** to start initialization.

L...	Capacity	Status	Property	Type	Free Space	Gr...	Edit	D...
1	931.51GB	Formatting 34%	R/W	Local	0MB	1		-

Figure 14-3 Start Initialization

Step 5 After the HDD has been initialized, the status of the HDD will change from *Uninitialized* to *Normal*.

L...	Capacity	Status	Property	Type	Free Space	Gr...	Edit	D...
1	931.51GB	Normal	R/W	Local	927GB	1		-

Figure 14-4 HDD Status Changes to Normal

NOTE

Initializing the HDD will erase all data on it.

The HDDs which are free of working for a long time can be enabled to sleep, thus to decrease the power consumption of the device and extend the life of the HDDs.

Go to **Menu > HDD > Advanced**.

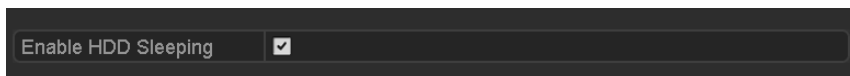

Figure 14-5 Enable HDD Sleeping

Check **Enable HDD Sleeping** (by default), and the HDDs which are free of working for a long time will be set to sleep.

Uncheck **Enable HDD Sleeping**, and the HDDs will be set to work for all time.

14.2 Managing Network HDD

Purpose

You can add the allocated NAS or disk of IP SAN to DVR, and use it as network HDD.

Step 1 Go to **Menu > HDD > General**.

L...	Capacity	Status	Property	Type	Free Space	Gr...	Edit	D...
1	931.51GB	Normal	R/W	Local	927GB	1		-

Figure 14-6 HDD Information Interface

Step 2 Click **Add** to enter the **Add NetHDD** interface, as shown in Figure 14-7.

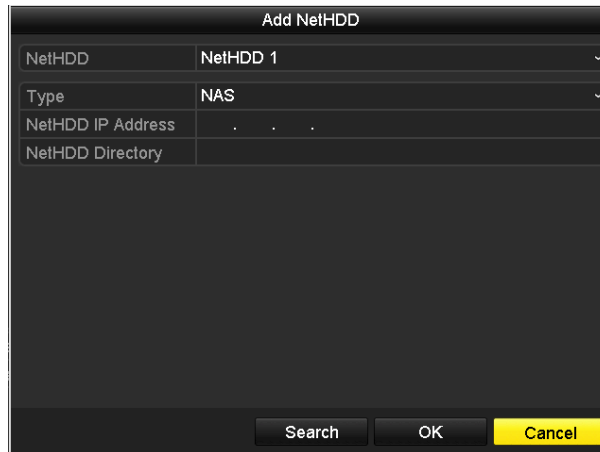

Figure 14-7 HDD Information Interface

Step 3 Add the allocated NetHDD.

Step 4 Select the type to NAS or IP SAN.

Step 5 Configure the NAS or IP SAN settings.

● **Add NAS disk:**

- 1) Enter the NetHDD IP address in the text field.
- 2) Click **Search** to search the available NAS disks.
- 3) Select the NAS disk from the list shown below.

Or you can just manually enter the directory in **NetHDD Directory**.

- 4) Click **OK** to add the configured NAS disk.



NOTE

Up to 8 NAS disks can be added.

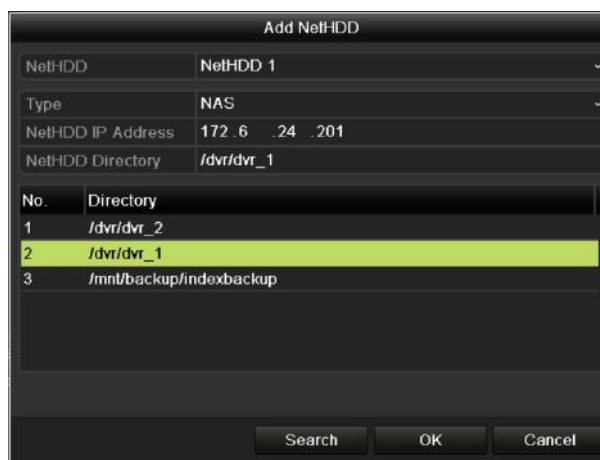

Figure 14-8 Add NAS Disk

● **Add IP SAN:**

- 1) Enter the NetHDD IP address in the text field.
- 2) Click **Search** to the available IP SAN disks.
- 3) Select the IP SAN disk from the list shown below.
- 4) Click **OK** to add the selected IP SAN disk.



NOTE

Up to 8 IP SAN disks can be added.



Figure 14-9 Add IP SAN Disk

- 5) After having successfully added the NAS or IP SAN disk, return to the HDD Information menu. The added NetHDD will be displayed in the list.



NOTE

If the added NetHDD is uninitialized, please select it and click **Init** for initialization.

<input type="checkbox"/>	L...	Capacity	Status	Property	Type	Free Space	Gr...	Edit	D...
<input checked="" type="checkbox"/>	1	931.51GB	Normal	R/W	Local	906GB	1		-
<input checked="" type="checkbox"/>	17	40,000MB	Normal	R/W	IP SAN	22,528MB	1		

Figure 14-10 Initialize Added NetHDD

14.3 Managing HDD Group

14.3.1 Setting HDD Groups

Purpose

Multiple HDDs can be managed in groups. Video from specified channels can be recorded onto a particular HDD group through HDD settings.

Step 1 Go to **Menu > HDD > Advanced**.

Step 2 Set **Mode** to Group, as shown below.



Figure 14-11 Storage Mode Interface

Step 3 Click **Apply** and the following Attention box will pop up.

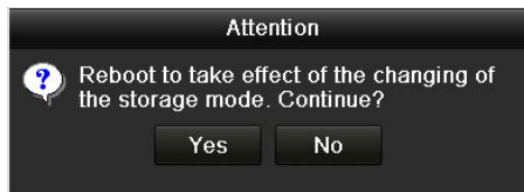

Figure 14-12 Attention for Reboot

Step 4 Click **Yes** to reboot the device to activate the changes.

Step 5 After reboot of device, go to **Menu > HDD > General**.

Step 6 Select HDD from the list and click the  icon to enter the **Local HDD Settings** interface, as shown below.



Figure 14-13 Local HDD Settings Interface

Step 7 Select the Group number for the current HDD.



NOTE

The default group No. for each HDD is 1.

Step 8 Click **OK** to confirm the settings.



Figure 14-14 Confirm HDD Group Settings

Step 9 In the pop-up Attention box, click **Yes** to finish the settings.

14.3.2 Setting HDD Property

Purpose

The HDD property can be set to redundancy, read-only or read/write (R/W). Before setting the HDD property, please set the storage mode to Group (refer to step1-4 of *Chapter 14.3.1 Setting HDD Groups*).

A HDD can be set to read-only to prevent important recorded files from being overwritten when the HDD becomes full in overwrite recording mode.

When the HDD property is set to redundancy, the video can be recorded both onto the redundancy HDD and the R/W HDD simultaneously so as to ensure high security and reliability of video data.

Step 1 Go to **Menu > HDD > General**.

Step 2 Select HDD from the list and click the  icon to enter the **Local HDD Settings** interface, as shown below.



Figure 14-15 Set HDD Property

Step 3 Set the HDD property to R/W, Read-only or Redundancy.

Step 4 Click **OK** to save the settings and exit the interface.

Step 5 In the HDD Information menu, the HDD property will be displayed in the list.

 **NOTE**

At least 2 hard disks must be added on your DVR when you want to set a HDD to Redundancy, and there is one HDD with R/W property.

14.4 Configuring Quota Mode

Purpose

Each camera can be configured with allocated quota for the storage of recorded files.

Steps

Step 1 Go to **Menu > HDD > Advanced > Storage Mode**.

Step 2 Set **Mode** to Quota, as shown below.



NOTE

The DVR must be rebooted to enable the changes to take effect.

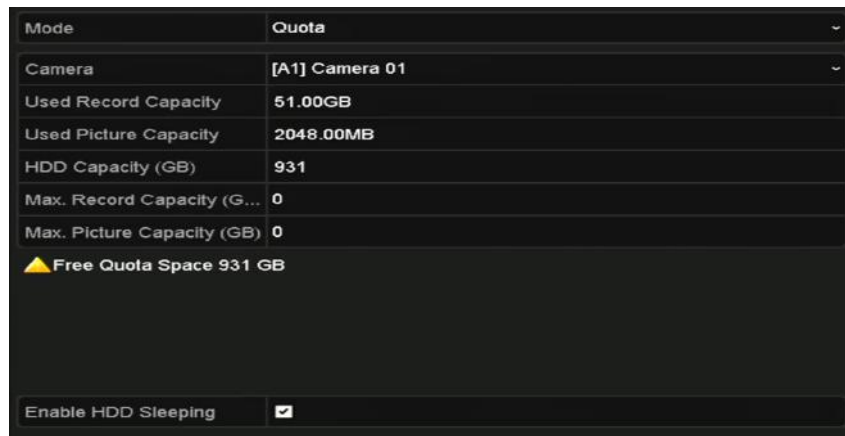

Figure 14-16 Storage Mode Settings Interface

Step 3 Select a camera for which you want to configure quota.

Step 4 Enter the storage capacity in the text field of **Max. Record Capacity (GB)**.

Step 5 You can copy the quota settings of the current camera to other cameras if required. Click **Copy** to enter **Copy Camera**, as shown below.



Figure 14-17 Copy Settings to Other Camera(s)

Step 6 Select the camera (s) to be configured with the same quota settings. You can also click the checkbox of Analog to select all cameras.

Step 7 Click **OK** to finish the Copy settings and back to the Storage Mode interface.

Step 8 Click **Apply** to apply the settings.



NOTE

If the quota capacity is set to 0, then all cameras will use the total capacity of HDD for record.

14.5 Configuring Cloud Storage

Purpose

The cloud storage facilitates you to upload and download the recorded files at any time and any place, which can highly enhance the efficiency.

Step 1 Go to **Menu > HDD > General > Cloud Storage**.

Step 2 Check **Enable Cloud** to enable the feature.

Step 3 Select **Cloud Type** from the drop-down list to One Drive, Google Drive or Drop Box.



Figure 14-18 Cloud Storage Interface

Step 4 According to the prompts, you are required to use a mobile browser to scan the QR code to log in the selected cloud to get the authentication code. And then copy the authentication code to **Authentication Code**.

Step 5 Click **Apply** and then back to the main menu.

Step 6 Enter the cloud storage interface again about 20s later. When **Status** shows online, it indicates the successful registration.

Step 7 Configure the recording schedule.

Back to enter the record interface, choose a certain camera from **Camera** and check **Enable Schedule** to enable the schedule recording. For detailed recording schedule, refer to 5.2 *Configuring Recording and Capture Schedule*.

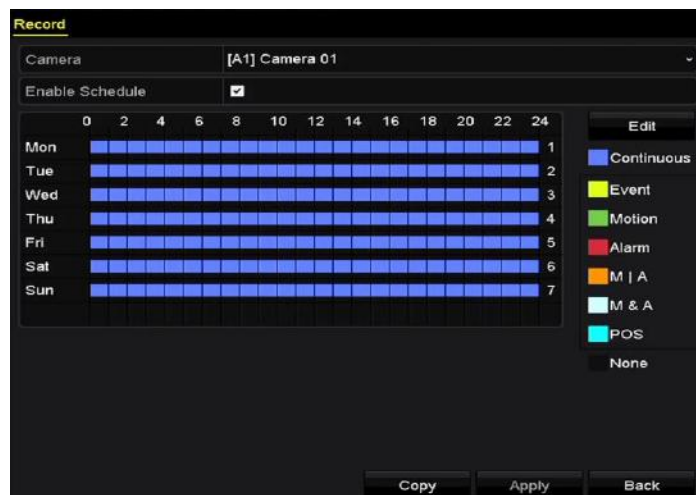

Figure 14-19 Record Schedule

Step 8 Upload the event triggered recording files to the cloud storage.

- 1) Back to enter the cloud storage interface, and select the camera you have set in the recording schedule interface.

- 2) Select the upload type in **Upload Type**.
- 3) Check **Enable Event Upload**.
- 4) Click **Apply** to finish the settings.



Figure 14-20 Upload to Cloud Storage Interface

NOTE

- Only the sub-stream recorded files can be uploaded to the Cloud Storage.
- Please configure the event triggered recording schedule and enable the corresponding event type.

Step 9 (Optional) You can click **Copy** to copy the cloud storage settings to other cameras. You can also click the checkbox of Analog/IP Camera to select all cameras.

Click **OK** to back to the cloud storage interface and click **Apply** to finish the settings.



Figure 14-21 Copy to Interface

14.6 Configuring Disk Clone

NOTE

This chapter is only applicable to the DVR with eSATA.

Purpose

If the S.M.A.R.T. detection result declares the HDD is abnormal, you can choose to clone all the data on the HDD to an inserted eSATA disk manually. Refer to *Chapter 14.8 Checking S.M.A.R.T. Information* for details of S.M.A.R.T detection.

Before you start

An eSATA disk should be connected to the device.

Step 1 Enter the HDD Advanced Setting interface:

Menu > HDD > Advanced

Step 2 Click **Disk Clone** to enter the disk clone configuring interface.

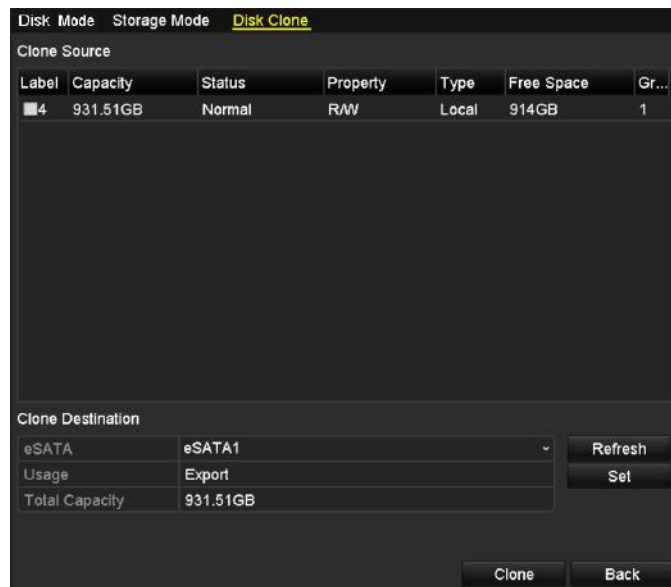

Figure 14-22 Disk Clone Configuration Interface

Step 3 Make sure the usage of the eSATA disk is set as Export.

If not, click **Set** to set it. Choose Export and click **OK**.



Figure 14-23 Setting eSATA Usage

NOTE

The capacity of destination disk must be the same as that of the clone source disk.

Step 4 Check the checkbox of the HDD to be cloned in the Clone Source list.

Step 5 Click **Clone** and a message box pops up.



Figure 14-24 Message Box for Disk Clone

Step 6 Click **Yes** to continue.

You can check the clone progress in the HDD status.

Label	Capacity	Status	Property	Type	Free Space	Gr...
4	931.51GB	Cloning 01%	R/W	Local	0MB	1

Figure 14-25 Check Disk Clone Progress

14.7 Checking HDD Status

Purpose

You may check the status of the installed HDDs on DVR so as to take immediate check and maintenance in case of HDD failure.

Checking HDD Status in HDD Information Interface

Step 1 Go to **Menu > HDD > General**.

Step 2 Check the status of each HDD which is displayed on the list, as shown below.

L...	Capacity	Status	Property	Type	Free Space	Gr...	Edit	D...
1	931.51GB	Normal	R/W	Local	900GB	1		-
17	199.97GB	Normal	Redundancy	NAS	182GB	1		

Figure 14-26 View HDD Status (1)



NOTE

If the status of HDD is *Normal* or *Sleeping*, it works normally. If the status is *Uninitialized* or *Abnormal*, please initialize the HDD before use. And if the HDD initialization is failed, please replace it with a new one.

Checking HDD Status in System Information Interface

Step 1 Go to **Menu > Maintenance > System Info > HDD**.

Step 2 View the status of each HDD displayed on the list, as shown below.

Label	Status	Capacity	Free Space	Property	Type	Group
1	Normal	931.51GB	900GB	R/W	Local	1
17	Normal	199.97GB	182GB	Redundancy	NAS	1

Figure 14-27 View HDD Status (2)

14.8 Checking S.M.A.R.T Information

Purpose

The S.M.A.R.T. (Self-Monitoring, Analysis and Reporting Technology) is a monitoring system for HDD to detect and report on various indicators of reliability in the hopes of anticipating failures.

Step 1 Go to **Menu > Maintenance > HDD Detect > S.M.A.R.T. Settings.**

Step 2 Select the HDD to view its S.M.A.R.T. information list, as shown below.



NOTE

If you want to use the HDD even when the S.M.A.R.T. checking is failed, you can check the checkbox before **Continue to use this disk when self-evaluation is failed.**

S.M.A.R.T. Settings Bad Sector Detection

Continue to use this disk when self-evaluation is failed.

HDD: 1

Self-test Status: Not tested

Self-test Type: Short Test

S.M.A.R.T.:

Temperature(C...: 34 Self-evaluation: Pass

Power On (da...: 329 All-evaluation: Functional

S.M.A.R.T. Information

ID	Attribute Name	Status	Flags	Threshold	Value	Worst	Raw Value
0x1	Raw Read Error Rate	OK	21	51	200	200	0
0x3	Spin Up Time	OK	27	21	112	107	7375
0x4	Start/Stop Count	OK	32	0	98	98	2333
0x5	Reallocated Sector Count	OK	33	140	200	200	0

Figure 14-28 S.M.A.R.T Settings Interface

14.9 Detecting Bad Sector

Purpose

You can detect the bad sector of the HDD to check the status of the HDD.

Step 1 Go to **Menu > Maintenance > HDD Detect > Bad Sector Detection.**

Step 2 Select a HDD and click **Detect** to start detecting.

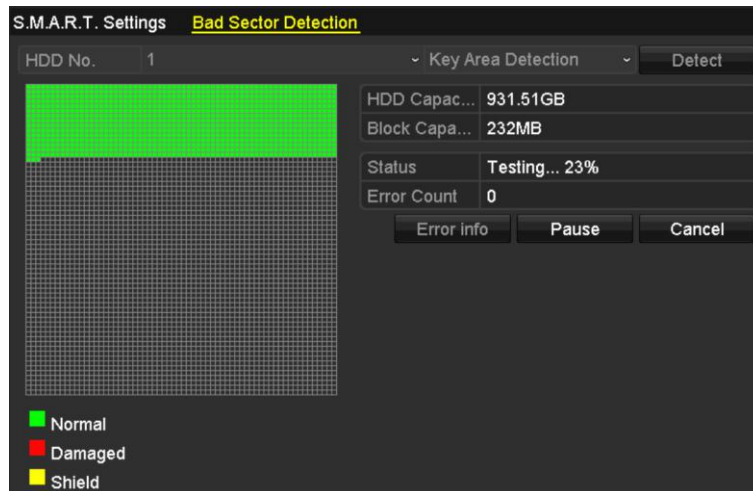

Figure 14-29 Bad Sector Detecting

Step 3 You can click **Pause** to pause the detection and click **Resume** to resume the detection.

Step 4 If there is error information about the HDD, you can click **Error Info** to view the information.

14.10 Configuring HDD Error Alarms

Purpose

You can configure the HDD error alarms when the HDD status is *Uninitialized* or *Abnormal*.

Step 1 Go to **Menu > Configuration > Exceptions**.

Step 2 Select the Exception Type to **HDD Error** from the drop-down list.

Step 3 Check the checkbox(s) below to select the linkage action(s) for HDD error, as shown in Figure 12-26.

The linkage actions can be selected to: Audible Warning, Notify Surveillance Center, Send Email and Trigger Alarm Output.

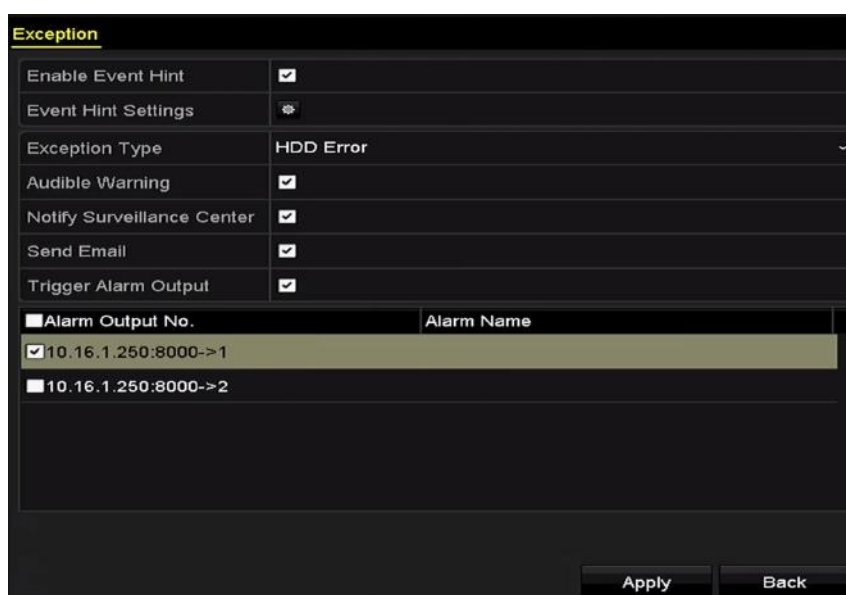

Figure 14-30 Configure HDD Error Alarm

Step 4 When **Trigger Alarm Output** is selected, you can also select the alarm output to be triggered from the list below.

Step 5 Click **Apply** to save the settings.

Chapter 15 Camera Settings

15.1 Configuring OSD Settings

Purpose

You can configure the OSD (On-Screen Display) settings for the camera, including date/time, camera name, etc.

Step 1 Go to **Menu > Camera > OSD**.

Step 2 Select the camera to configure OSD settings.

Step 3 Edit **Camera Name**.

Step 4 Configure **Display Name**, **Display Date** and **Display Week** by checking the checkbox.

Step 5 Select **Date Format**, **Time Format**, **Display Mode** and **OSD Font**.

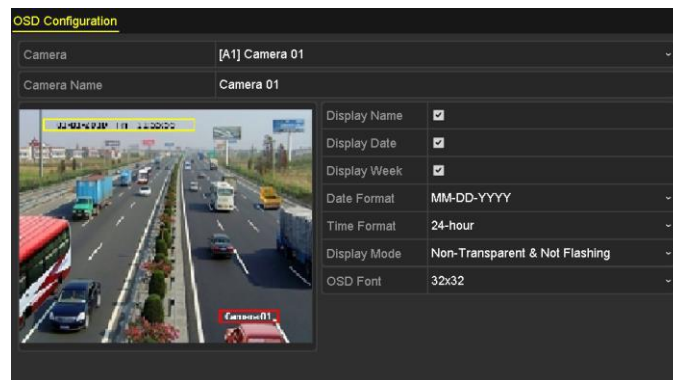

Figure 15-1 OSD Configuration Interface

Step 6 You can use the mouse to drag the text frame on the preview window to adjust the OSD position.

Step 7 Copy Camera Settings

- 1) If you want to copy the OSD settings of the current camera to other cameras, click **Copy** to enter the **Copy Camera** interface, as shown in Figure 15-2.

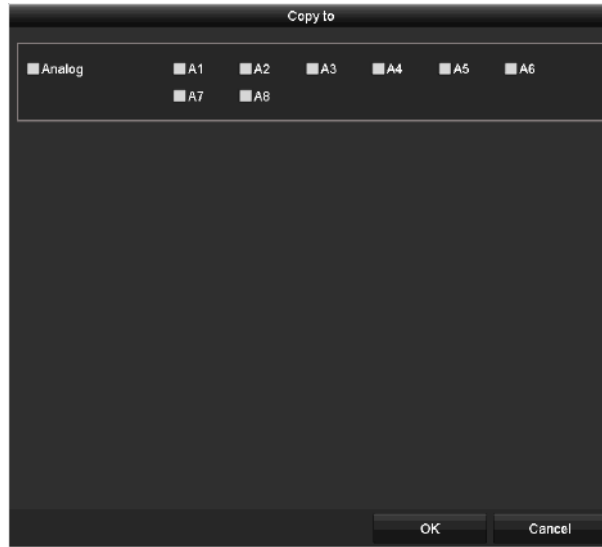

Figure 15-2 Copy Settings to Other Cameras

- 2) Select the camera (s) to be configured with the same OSD settings. You can also check **Analog** to select all cameras.
- 3) Click **OK** to finish the **Copy** settings and back to the **OSD Configuration** interface.

Step 8 Click **Apply** to apply the settings.

15.2 Configuring Privacy Mask

Purpose

You are allowed to configure the four-sided privacy mask zones that cannot be viewed or recorded by the operator.

Step 1 Go to **Menu > Camera > Privacy Mask**.

Step 2 Select the camera to set privacy mask.

Step 3 Check **Enable Privacy Mask** to enable this feature.



Figure 15-3 Privacy Mask Settings Interface

Step 4 Use the mouse to draw a zone on the window. The zones will be marked with different frame colors.

 **NOTE**

Up to 4 privacy mask zones can be configured, and the size of each area can be adjusted.

Step 5 The configured privacy mask zones on the window can be cleared by clicking the corresponding **Clear Zone1-4** icons on the right side of the window, or click **Clear All** to clear all zones.



Figure 15-4 Set Privacy Mask Area

Step 6 You can click **Copy** to copy the privacy mask settings of the current camera to other cameras.

Please refer to step 7 of *Chapter 15.1 Configuring OSD Settings*.

Step 7 Click **Apply** to save the settings.

15.3 Configuring Video Parameters

15.3.1 Configuring Image Settings

Step 1 Go to **Menu > Camera > Image > Image Settings**.

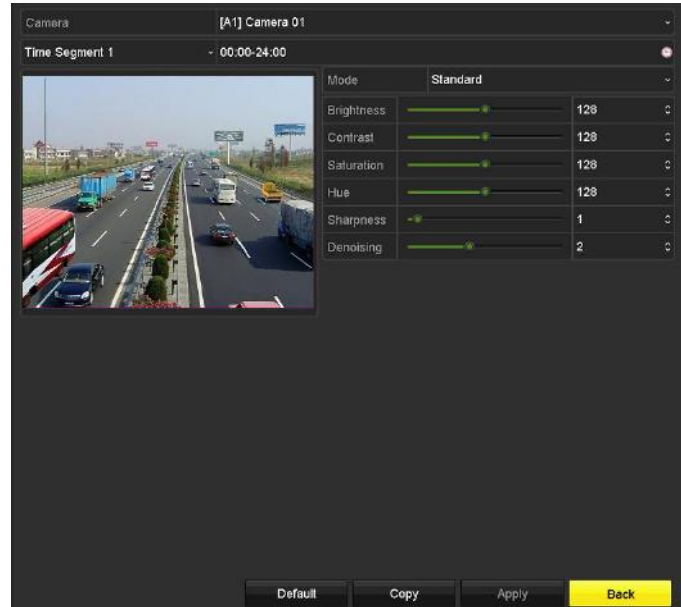

Figure 15-5 Image Settings Interface (Analog Camera)



Figure 15-6 Image Settings Interface (IP Camera)

Step 2 Select the camera to set image parameters.

Step 3 Two periods for different image settings are provided, select the period name in the drop-down list.



NOTE

The time periods cannot be overlapped with each other.

Step 4 Select the mode from **Mode**, there are four modes selectable for the analog cameras: Standard, Indoor, Dim Light and Outdoor.

Step 5 Adjust the image parameters according to actual needs. The parameters include Brightness, Contrast, Saturation, Hue, Sharpness and Denoising for the analog cameras and Brightness, Contrast and Saturation for the IP cameras. You can also click **Restore** to set the parameters to the default settings.

Step 6 You can click **Copy** to copy the image settings of the current camera to other cameras.

Step 7 Click **Apply** to save the settings.

15.3.2 Configuring Camera Parameters Settings

Step 1 Go to **Menu > Camera > Image > Camera Parameters Settings**.



Figure 15-7 Camera Parameters Settings

Step 2 Select **Camera** from the drop-down list.

Step 3 Configure the parameters.

- Switch the 4 MP or 5 MP signal from **Signal Switch**. 4 MP 25/30 fps and 5 MP 20 fps are selectable. The 4 MP 25 fps and 4 MP 30 fps signals are self-adaptive for the camera.
- Check **Enable Defog** to enable the defog function of the selected camera. And set the **Defog Level** from 1 to 4.
- Adjust the parameters including **Day to Night Sensitivity**, **Night to Day Sensitivity** and **IR Light Brightness** for the analog cameras.
- Select **Day/Night Mode** of the camera from the drop-down list.
- Check **WDR Switch** to enable the function of the camera.

Step 4 (Optional) Click **Default** to set the parameters to the default settings.

Step 5 (Optional) Click **Copy** to copy the parameters of the current camera to other analog cameras.

Step 6 Click **Apply** to save the settings.

NOTE

- The camera parameters settings is only applicable for analog cameras.

- The 4 MP/5 MP Signal Switch, Defog, Day to Night Sensitivity, Night to Day Sensitivity, IR Light Brightness, Day/Night Mode, and WDR Switch functions must be supported by the connected analog camera. You cannot set the parameters if the connected analog camera does not support them or there is no video signal.
- The parameters are saved to the connected analog camera and are not saved to the DVR.
- The default value of Day to Night Sensitivity, Night to Day Sensitivity and IR Light Brightness is 5. The effective value ranges from 1 to 9.
- If you exit from the interface and enter it again, the parameters displayed are those you have set the last time.
- The DVR connects to the analog camera via coaxitron and there is no response mechanism. Even if the coaxitron is abnormal, the parameters are still displayed to be set successfully.

Chapter 16 DVR Management and Maintenance

16.1 Viewing System Information

Step 1 Go to **Menu > Maintenance > System Info**.

Step 2 You can click **Device Info**, **Camera**, **Record**, **Alarm**, **Network** and **HDD** to view the system information of the device.

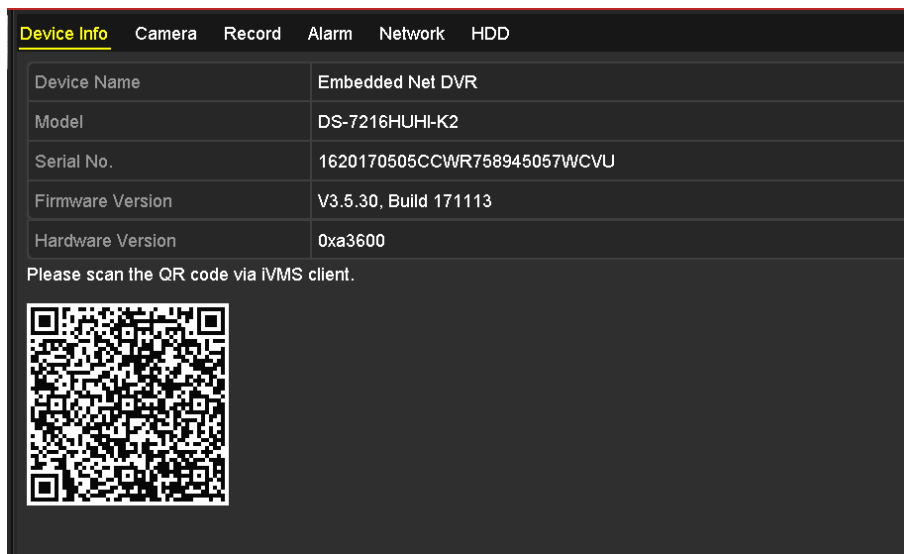

Figure 16-1 System Information Interface

16.2 Searching Log Files

Purpose

The operation, alarm, exception and information of the DVR can be stored in log files, which can be viewed and exported at any time.

Step 1 Go to **Menu > Maintenance > Log Information**.

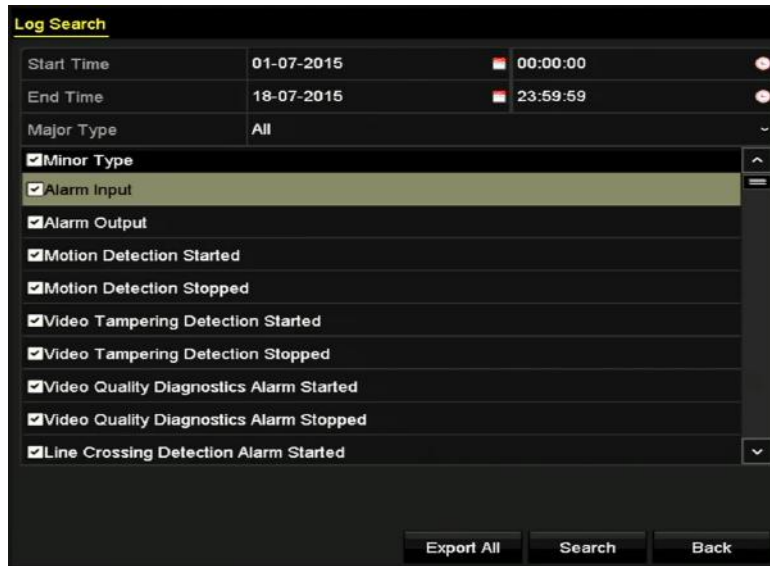

Figure 16-2 Log Search Interface

Step 2 Set the log search conditions to refine your search, including the Start Time, End Time, Major Type and Minor Type.

Step 3 Click **Search** to start search log files.

Step 4 The matched log files will be displayed on the list shown below.



NOTE

Up to 2000 log files can be displayed each time.

No.	Major Type	Time	Minor Type	Parameter	Play	Details
1	Information	10-07-2015 09:53:59	Local HDD Infor...	N/A	—	✓
2	Operation	10-07-2015 09:53:59	Power On	N/A	—	✓
3	Information	10-07-2015 09:54:05	Start Recording	N/A	⏮	✓
4	Operation	10-07-2015 09:54:08	Local Operation:...	N/A	—	✓
5	Information	10-07-2015 09:54:25	HDD S.M.A.R.T.	N/A	—	✓
6	Information	10-07-2015 09:54:32	Start Recording	N/A	⏮	✓
7	Operation	10-07-2015 09:54:32	Local Operation:...	N/A	⏮	✓
8	Operation	10-07-2015 09:54:32	Local Operation:...	N/A	⏮	✓
9	Exception	10-07-2015 09:55:32	IP Camera Disco...	N/A	⏮	✓
10	Information	10-07-2015 10:04:09	System Running...	N/A	—	✓

Total: 2000 P: 1/20

Figure 16-3 Log Search Results

Step 5 You can click the button of each log or double-click it to view its detailed information. And you can also click the button to view the related video files if available.

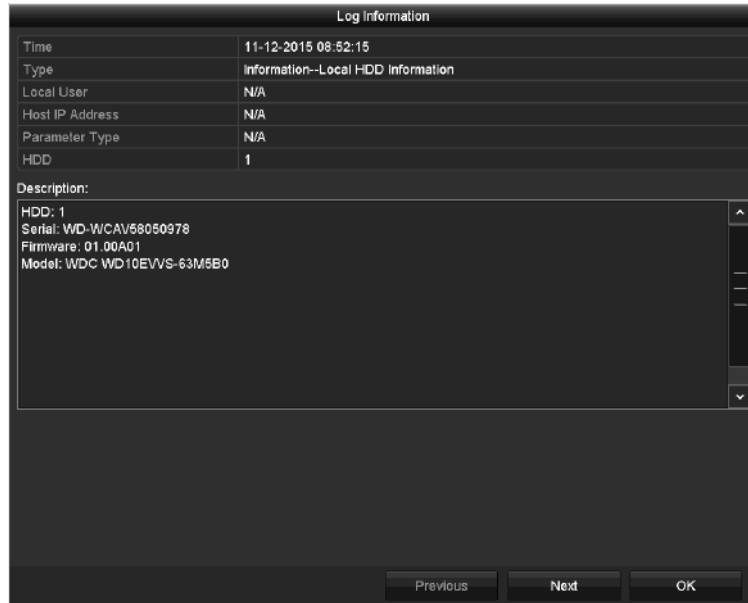

Figure 16-4 Log Information Interface

Step 6 If you want to export the log files, click **Export** to enter the Export menu, as shown below.



Figure 16-5 Export Log Files

Step 7 Select the backup device from **Device Name**.

Step 8 Click **Export** to export the log files to the selected backup device.

You can click **New Folder** to create new folder in the backup device, or click **Format** to format the backup device before log export.

 **NOTE**

- Please connect the backup device to DVR before operating log export.
- The log files exported to the backup device are named by exporting time, e.g., *20110514124841logBack.txt*.

16.3 Importing/Exporting IP Camera Info

Purpose

The information of added IP camera can be generated into an excel file and exported to the local device for backup, including the IP address, manage port, password of admin, etc. And the exported file can be edited on your PC, like adding or deleting the content, and copy the setting to other devices by importing the excel file to it.

Step 1 Go to **Menu > Camera > Camera > IP Camera Import/Export**.

Step 2 Click **Export** to export configuration files to the selected local backup device.

Step 3 To import a configuration file, select the file from the selected backup device and click **Import**. After the importing process is completed, you must reboot the DVR.

16.4 Importing/Exporting Configuration Files

Purpose

The configuration files of the DVR can be exported to local device for backup; and the configuration files of one DVR can be imported to multiple DVR devices if they are to be configured with the same parameters.

Step 1 Go to **Menu > Maintenance > Import/Export**.



Figure 16-6 Import/Export Configuration File

Step 2 Click **Export** to export configuration files to the selected local backup device.

Step 3 To import a configuration file, select the file from the selected backup device and click **Import**. After the import process is completed, you must reboot the DVR.



NOTE

After having finished the import of configuration files, the device will reboot automatically.

16.5 Upgrading System

Purpose

The firmware on your DVR can be upgraded by local backup device or remote FTP server.

16.5.1 Upgrading by Local Backup Device

Step 1 Connect your DVR with a local backup device where the update firmware file is located.

Step 2 Go to **Menu > Maintenance > Upgrade > Local Upgrade**.

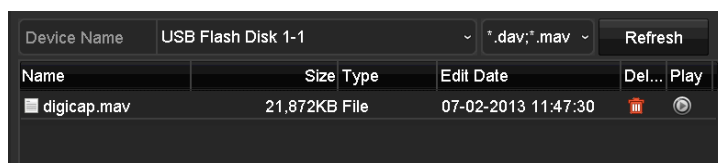

Figure 16-7 Local Upgrade Interface

Step 3 Select the update file from the backup device.

Step 4 Click **Upgrade** to start upgrading.

Step 5 After the upgrading is completed, reboot the DVR to activate the new firmware.

16.5.2 Upgrading by FTP

Before you start

Configure PC (running FTP server) and DVR to the same Local Area Network. Run the 3rd-party TFTP software on the PC and copy the firmware into the root directory of TFTP.

Step 1 Go to **Menu > Maintenance > Upgrade > FTP**.



Figure 16-8 FTP Upgrade Interface

Step 2 Enter the FTP Server Address in the text field.

Step 3 Click **Upgrade** to start upgrading.

Step 4 After the upgrading is completed, reboot the DVR to activate the new firmware.

16.6 Upgrading Camera

Purpose

You can upgrade multiple connected analog cameras supporting Turbo HD or AHD signal simultaneously with DVR.

Step 1 Go to **Menu > Maintenance > Upgrade > Camera Upgrade**.

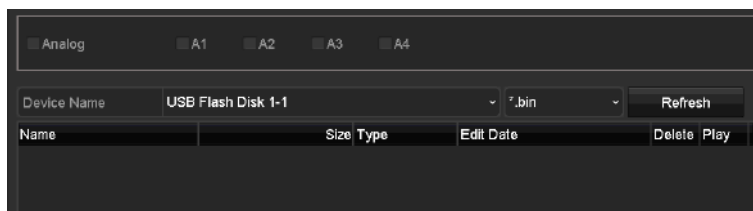

Figure 16-9 Camera Upgrade

Step 2 Check the checkbox(es) of the analog camera(s) for upgrading.



The analog camera must support Turbo HD or AHD signal.

Step 3 Select the update file from the backup device.

Step 4 Click **Upgrade** to start upgrading.

16.7 Restoring Default Settings

Step 1 Go to **Menu > Maintenance > Default**.

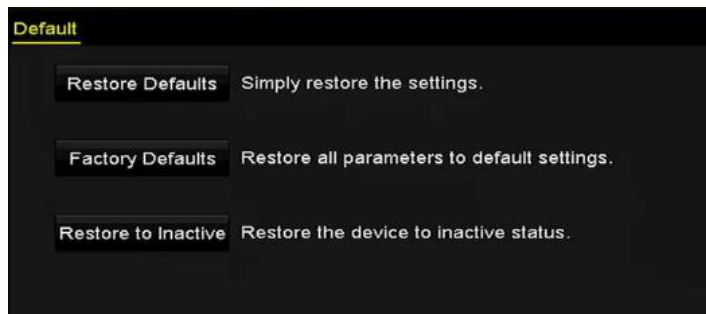

Figure 16-10 Restore Defaults

Step 2 Select the restoring type from the following three options.

Restore Defaults: Restore all parameters, except the network (including IP address, subnet mask, gateway, MTU, NIC working mode, default route, server port, etc.) and user account parameters, to the factory default settings.

Factory Defaults: Restore all parameters to the factory default settings.

Restore to Inactive: Restore the device to the inactive status.

Step 3 Click **OK** to restore the default settings.



The device will reboot automatically after restoring to the default settings.

Chapter 17 Others

17.1 Configuring General Settings

Purpose

You can configure the output resolution, system time, mouse pointer speed, etc.

Step 1 Go to **Menu > Configuration > General > General**.

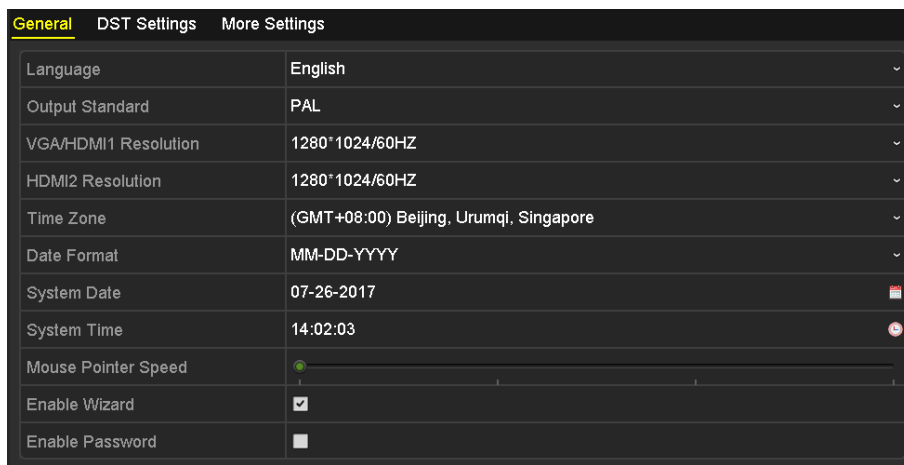

Figure 17-1 General Settings Interface (for DS-7300/9000HUHI Series)

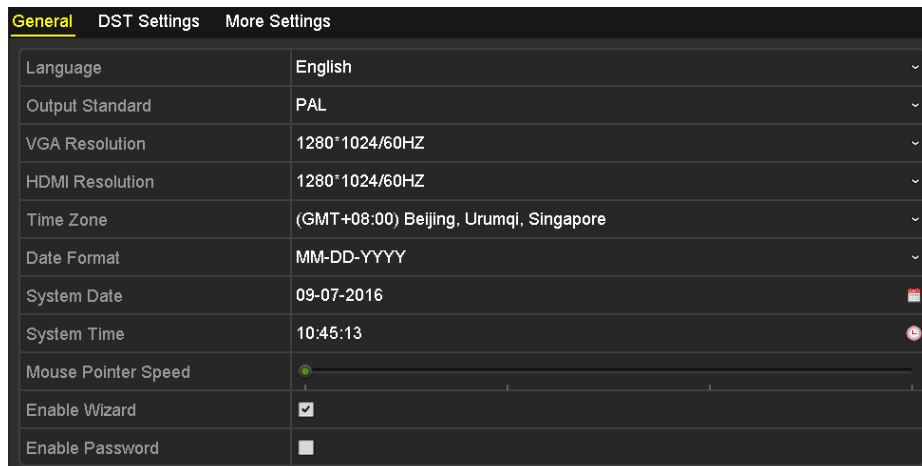

Figure 17-2 General Settings Interface (for 73HQHI-K series)

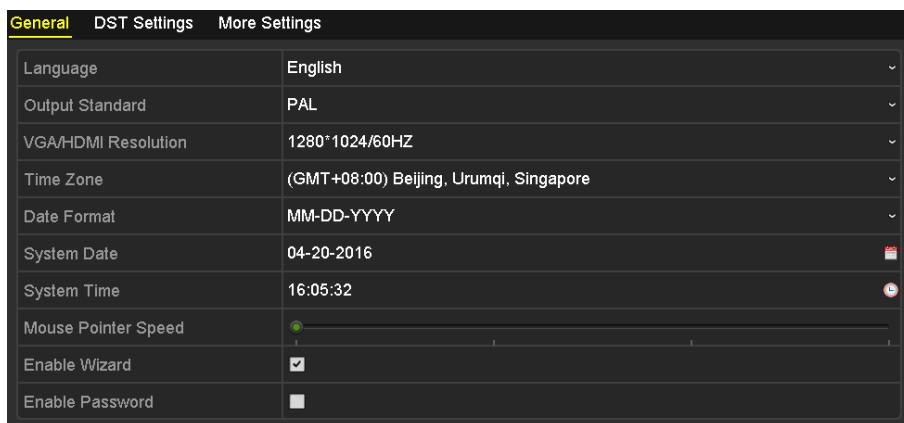

Figure 17-3 General Settings Interface (for Other Models)

Step 2 Configure the following settings:

- **Language:** The default language used is *English*.
- **Output Standard:** Select the output standard to be PAL or NTSC.
- **VGA/HDMI Resolution:** Select the output resolution, which must be the same with the resolution of the VGA/HDMI display.

 **NOTE**

- For DS-7300/9000HUHI-K series, **VGA/HDMI1 Resolution** and **HDMI2 Resolution** can be configured separately. Up to 1920 × 1080/60 Hz resolution is supported for VGA/HDMI1 output and up to 4K (3840 × 2160)/30 Hz resolution is supported for HDMI2 output.
- For 7300HQHI-K series, the HDMI and VGA interfaces can be configured to be simultaneous or independent (Refer to *Chapter 17.4 Configuring More Settings* for reference). If you have configured HDMI/VGA simultaneous output, you can set the **VGA/HDMI Resolution**. If you have configured independent HDMI and VGA output, you can set the **VGA Resolution** and **HDMI Resolution** independently. Up to 1920 × 1080/60 Hz resolution is supported for VGA output and up to 4K (3840 × 2160)/30 Hz resolution is supported for HDMI output.
- **Time Zone:** Select the time zone.
- **Date Format:** Select the date format.
- **System Date:** Select the system date.
- **System Time:** Select the system time.
- **Mouse Pointer Speed:** Set the speed of mouse pointer; 4 levels are configurable.
- **Enable Wizard:** Enable/disable the Wizard when the device starts up.
- **Enable Password:** Enable/disable the use of the login password.

 **NOTE**

If you check **Enable Password**, every time when you log in to the DVR, the Unlock Pattern interface will pop up. If you uncheck **Enable Password**, when you log in to the DVR, the Unlock Pattern interface will not pop up.

Step 3 Click **Apply** to save the settings.

17.2 Configuring RS-232 Serial Port



The RS-232 serial port is supported by DS-7300HQHI and DS-7300/9000HUHI series DVR.

Purpose

The RS-232 port can be used in two ways:

- **Parameters Configuration:** Connect a PC to the DVR through the PC serial port. Device parameters can be configured by using software such as HyperTerminal. The serial port parameters must be the same as the NVR's when connecting with the PC serial port.
- **Transparent Channel:** Connect a serial device directly to the DVR. The serial device will be controlled remotely by the PC through the network and the protocol of the serial device.

Step 1 Go to **Menu > Configuration > RS-232**.



Figure 17-4 RS-232 Settings Interface

Step 2 Configure RS-232 parameters, including baud rate, data bit, stop bit, parity, flow control and usage.

Step 3 Click **Apply** to save the settings.

17.3 Configuring DST Settings

Step 1 Go to **Menu > Configuration > General > DST Settings**.



Figure 17-5 DST Settings Interface

Step 2 Check the checkbox before **Auto DST Adjustment**.

Or you can manually check **Enable DST**, and then you choose the date of the DST period.

17.4 Configuring More Settings

Step 1 Go to **Menu > Configuration > General > More Settings**.

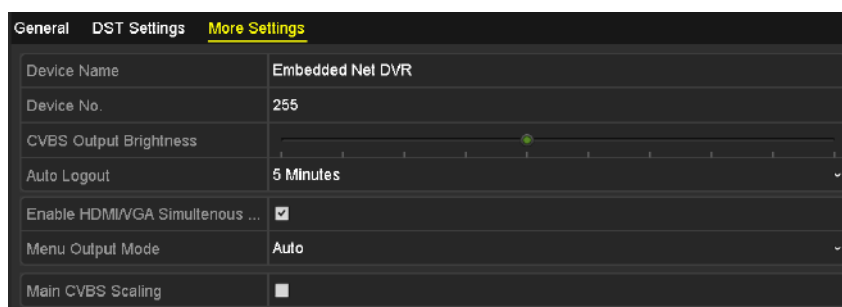

Figure 17-6 More Setting Interface (for 7300HQHI-K series DVR)

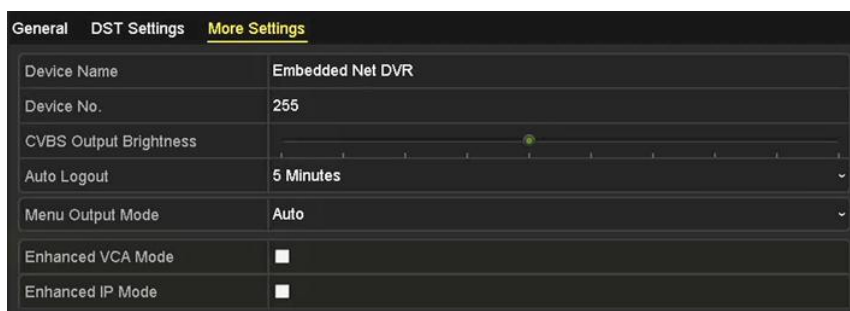

Figure 17-7 More Settings Interface (for other models)

Step 2 Configure the following settings:

- **Device Name:** Edit the name of DVR.
- **Device No.:** Edit the serial number of DVR. The Device No. can be set in the range of 1 to 255, and the default No. is 255.
- **Auto Logout:** Set timeout time for menu inactivity. E.g., when the timeout time is set to 5 *Minutes*, then the system will exit from the current operation menu to live view screen after 5 minutes of menu inactivity.
- **CVBS Output Brightness:** Adjust the video output brightness via the CVBS interface.
- **Menu Output Mode:** You can choose the menu display on different video output.
For DS-7300/9000HUHI-K series, **Auto**, **HDMI1/VGA**, and **HDMI2** are selectable.
For other models, **Auto** and **HDMI/VGA** are selectable.
- **Enhanced VCA Mode:** For HUHI series DVR, the enhanced VCA mode conflicts with the 2K/4K output and 4 MP/5 MP/8 MP signal input. If you have configured 2K/4K output, or

connected 4 MP/5 MP/8 MP signal input already, when you enable enhanced VCA mode, the output resolution will decrease to 1080p, and the 4 MP/5 MP/8 MP signal input will display no video.

- **Enhanced IP Mode:** Enabling enhanced IP mode will allow you to connect to the maximum number of cameras, but disable all VCA functions. It conflicts with the enhanced VCA mode.
- **Enable HDMI/VGA Simultaneous Output:** For 7300HQHI-K series DVR, the HDMI and VGA interfaces can be configured to be simultaneous or independent. You can check the checkbox to enable HDMI/VGA simultaneous output or uncheck it to remain independent output of HDMI and VGA interfaces.

17.5 Managing User Accounts

Purpose

There is a default account in the DVR: *Administrator*. The *Administrator* user name is *admin* and the password is set when you start the device for the first time. The *Administrator* has the permission to add and delete user and configure user parameters.

17.5.1 Adding a User

Step 1 Go to **Menu > Configuration > User**.

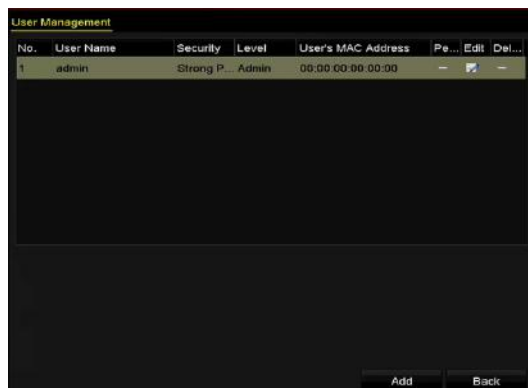

Figure 17-8 User Management Interface

Step 2 Click **Add** to enter the **Add User** interface.

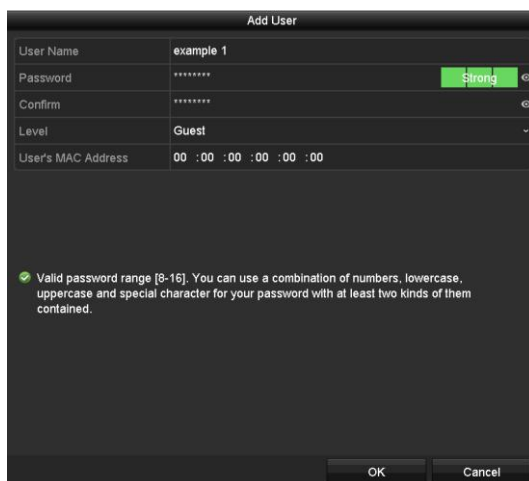

Figure 17-9 Add User Menu

Step 3 Enter the information for new user, including **User Name**, **Password**, **Confirm**, **Level** and **User's MAC Address**.

Password: Set the password for the user account.



WARNING

STRONG PASSWORD RECOMMENDED-We highly recommend you create a strong password of your own choosing (Using a minimum of 8 characters, including at least three of the following categories: upper case letters, lower case letters, numbers, and special characters.) in order to increase the security of your product. And we recommend you reset your password regularly, especially in the high security system, resetting the password monthly or weekly can better protect your product.

Level: Set the user level to Operator or Guest. Different user levels have different operating permission.

- **Operator:** The *Operator* user level has permission of Two-way Audio in Remote Configuration and all operating permission in Camera Configuration by default.
- **Guest:** The *Guest* user has no permission of Two-way Audio in Remote Configuration and only has the local/remote playback in the Camera Configuration by default.

User's MAC Address: The MAC address of the remote PC which logs onto the DVR. If it is configured and enabled, it only allows the remote user with this MAC address to access the DVR.

Step 4 Click **OK** to save the settings and go back to the **User Management** interface. The added new user will be displayed on the list, as shown below.

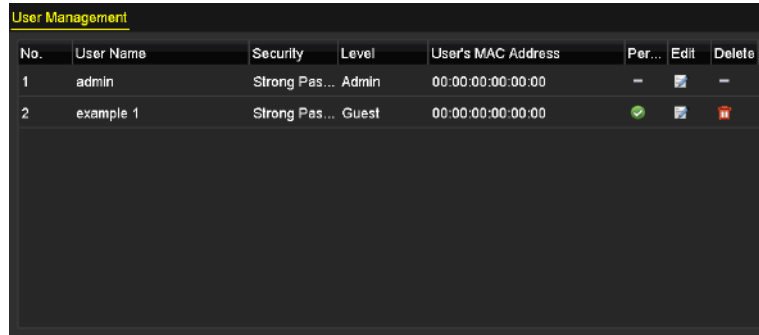

No.	User Name	Security	Level	User's MAC Address	Per...	Edit	Delete
1	admin	Strong Pas...	Admin	00:00:00:00:00:00	-		-
2	example 1	Strong Pas...	Guest	00:00:00:00:00:00			

Figure 17-10 Added User Listed in User Management Interface

Step 5 You can assign permissions for the added user.

- 1) Select the user from the list and then click  to enter the **Permission Settings** interface, as shown below.



Figure 17-11 User Permission Settings Interface

- 2) Set the operating permission of Local Configuration, Remote Configuration and Camera Configuration for the user.

Local Configuration

- Local Log Search: Searching and viewing logs and system information of device.
- Local Parameters Settings: Configuring parameters, restoring factory default parameters and importing/exporting configuration files.
- Local Camera Management: Enabling and disabling analog camera (s). Adding, deleting and editing of network camera (s). This function is supported by HDVR series.
- Local Advanced Operation: Operating HDD management (initializing HDD, setting HDD property), upgrading system firmware.
- Local Shutdown /Reboot: Shutting down or rebooting the device.

Remote Configuration

- Remote Log Search: Remotely viewing logs that are saved on the device.
- Remote Parameters Settings: Remotely configuring parameters, restoring factory default parameters and importing/exporting configuration files.
- Remote Camera Management: Remotely enabling and disabling analog camera (s), and adding, deleting and editing of network camera (s). This function is supported by HDVR series.
- Remote Serial Port Control: Configuring settings for RS-485 port.
- Remote Video Output Control: Sending remote control panel signal.
- Two-way Audio: Realizing two-way radio between the remote client and the device.
- Remote Alarm Control: Remotely arming (notify alarm and exception message to the remote client) and controlling the alarm output.
- Remote Advanced Operation: Remotely operating HDD management (initializing HDD, setting HDD property), upgrading system firmware.
- Remote Shutdown/Reboot: Remotely shutting down or rebooting the device.

Camera Configuration

- Remote Live View: Remotely viewing live video of the selected camera (s).
- Local Manual Operation: Locally starting/stopping manual recording, picture capturing and alarm output of the selected camera (s).
- Remote Manual Operation: Remotely starting/stopping manual recording, picture capturing and alarm output of the selected camera (s).
- Local Playback: Locally playing back recorded files of the selected camera (s).
- Remote Playback: Remotely playing back recorded files of the selected camera (s).
- Local PTZ Control: Locally controlling PTZ movement of the selected camera (s).
- Remote PTZ Control: Remotely controlling PTZ movement of the selected camera (s).
- Local Video Export: Locally exporting recorded files of the selected camera (s).



NOTE

Local Camera Management is provided for the IP cameras only.

- 3) Click **OK** to save the settings and exit.

17.5.2 Deleting a User

Step 1 Go to **Menu > Configuration > User**.

Step 2 Select the user to be deleted from the list, as shown below.

No.	User Name	Security	Level	User's MAC Address	Per...	Edit	Delete
1	admin	Strong Pas...	Admin	00:00:00:00:00:00	-		-
2	example 1	Strong Pas...	Guest	00:00:00:00:00:00			

Figure 17-12 User List

Step 3 Click to delete the selected user account.

17.5.3 Editing a User

Purpose

For the added user accounts, you can edit the parameters.

Step 1 Go to **Menu > Configuration > User**.

Step 2 Select the user to be edited from the list.

Step 3 Click the icon to enter the **Edit User** interface, as shown below.

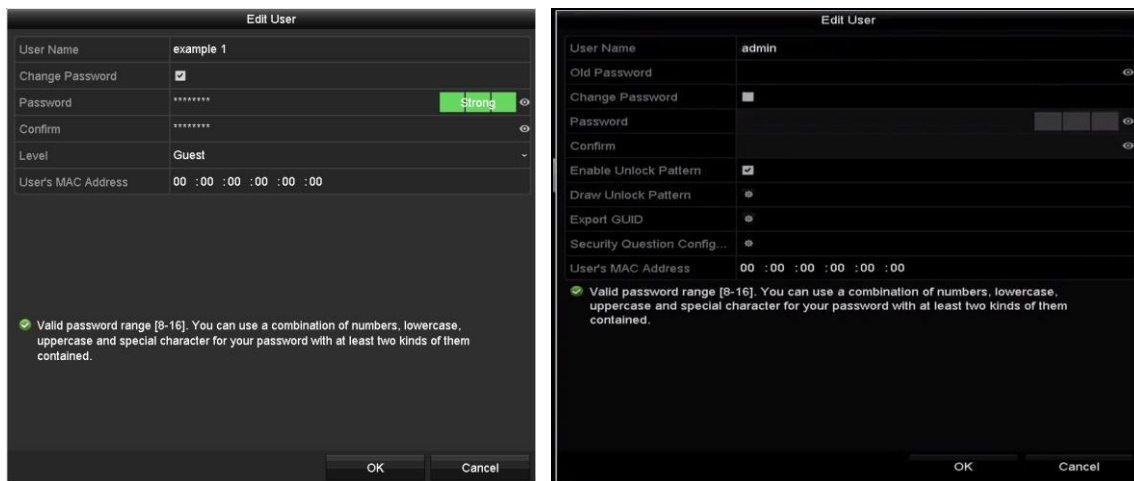

Figure 17-13 Edit User Interface

Step 4 Edit the corresponding parameters.

- **Operator and Guest**

You can edit the user information, including user name, password, permission level and MAC address. Check **Change Password** if you want to change the password, and input the new password in **Password** and **Confirm**. A strong password is recommended.

- **Admin**

You are only allowed to edit the password and MAC address. Check **Change Password** if you want to change the password, and input the correct old password, and the new password in **Password** and **Confirm**.



WARNING

STRONG PASSWORD RECOMMENDED-We highly recommend you create a strong password of your own choosing (Using a minimum of 8 characters, including at least three of the following categories: upper case letters, lower case letters, numbers, and special characters.) in order to increase the security of your product. And we recommend you reset your password regularly, especially in the high security system, resetting the password monthly or weekly can better protect your product.



NOTE

Hold the  icon and you can see the clear text of the password. Release the mouse and the content of the password restores invisible.

Step 5 Edit the unlock pattern for the *admin* user account.

- 1) Check **Enable Unlock Pattern** to enable the use of unlock pattern when logging in to the device.
- 2) Use the mouse to draw a pattern among the 9 dots on the screen. Release the mouse when the pattern is done.
- 3) Confirm the pattern again with the mouse.



NOTE

Please refer to *Chapter 2.3.1 Configuring the Unlock Pattern* for detailed instructions.

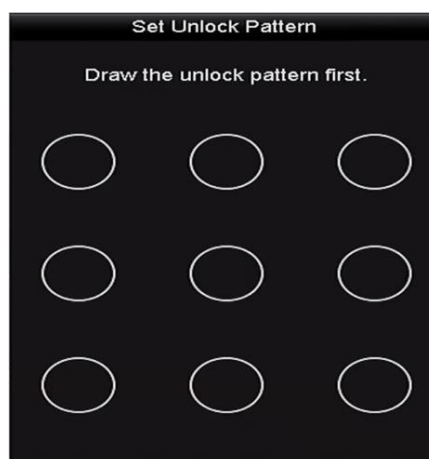



Figure 17-14 Set Unlock Patter for Admin User

Step 6 (Optional) Click  icon after **Draw Unlock Pattern** to modify the pattern.

Step 7 (Optional) Click  icon after **Export GUID** to pop up the Reset Password interface. Click **Export** to export GUID to the USB flash drive for retrieving the forgotten password. Then a GUID file will be saved in the USB flash drive.

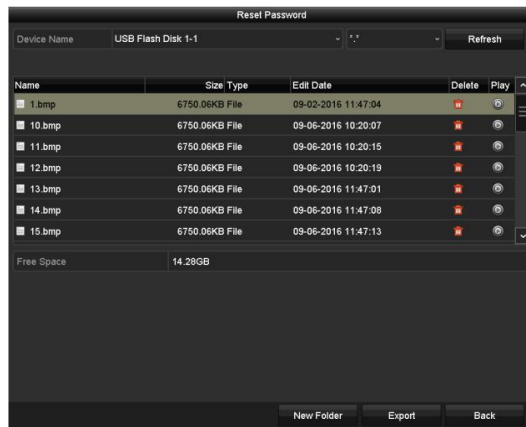



Figure 17-15 Export GUID

Step 8 (Optional) Click  icon after **Security Questions Configuration** to pop up the **Security Question Configuration** interface. Please refer to Chapter 2.2 Activating the Device.

NOTE

You must input the correct old password of the *admin* before exporting GUID.

Step 9 Click **OK** to save the settings and exit from the menu.

Step 10 (Optional) For the **Operator** or **Guest** user account, you can also click the  button on the **User Management** interface to edit the permission.

Chapter 18 Appendix

18.1 Glossary

- **Dual-Stream:** Dual-stream is a technology used to record high resolution video locally while transmitting a lower resolution stream over the network. The two streams are generated by the DVR, with the main stream having a maximum resolution of 1080P and the sub-stream having a maximum resolution of CIF.
- **DVR:** Acronym for Digital Video Recorder. A DVR is device that is able to accept video signals from analog cameras, compress the signal and store it on its hard drives.
- **HDD:** Acronym for Hard Disk Drive. A storage medium which stores digitally encoded data on platters with magnetic surfaces.
- **DHCP:** Dynamic Host Configuration Protocol (DHCP) is a network application protocol used by devices (DHCP clients) to obtain configuration information for operation in an Internet Protocol network.
- **HTTP:** Acronym for Hypertext Transfer Protocol. A protocol to transfer hypertext request and information between servers and browsers over a network
- **PPPoE:** PPPoE, Point-to-Point Protocol over Ethernet, is a network protocol for encapsulating Point-to-Point Protocol (PPP) frames inside Ethernet frames. It is used mainly with ADSL services where individual users connect to the ADSL transceiver (modem) over Ethernet and in plain Metro Ethernet networks.
- **DDNS:** Dynamic DNS is a method, protocol, or network service that provides the capability for a networked device, such as a router or computer system using the Internet Protocol Suite, to notify a domain name server to change, in real time (ad-hoc) the active DNS configuration of its configured hostnames, addresses or other information stored in DNS.
- **Hybrid DVR:** A hybrid DVR is a combination of a DVR and NVR.
- **NTP:** Acronym for Network Time Protocol. A protocol designed to synchronize the clocks of computers over a network.
- **NTSC:** Acronym for National Television System Committee. NTSC is an analog television standard used in such countries as the United States and Japan. Each frame of an NTSC signal contains 525 scan lines at 60Hz.
- **NVR:** Acronym for Network Video Recorder. An NVR can be a PC-based or embedded system used for centralized management and storage for IP cameras, IP Domes and other DVRs.
- **PAL:** Acronym for Phase Alternating Line. PAL is also another video standard used in broadcast televisions systems in large parts of the world. PAL signal contains 625 scan lines at 50Hz.
- **PTZ:** Acronym for Pan, Tilt, Zoom. PTZ cameras are motor driven systems that allow the camera to pan left and right, tilt up and down and zoom in and out.

- **USB:** Acronym for Universal Serial Bus. USB is a plug-and-play serial bus standard to interface devices to a host computer.

18.2 Troubleshooting

● **No image displayed on the monitor after the device is starting up normally.**

Possible Reasons:

- No VGA or HDMI connections.
- Connection cable is damaged.
- Input mode of the monitor is incorrect.

Step 1 Verify the device is connected with the monitor via HDMI or VGA cable.

If not, please connect the device with the monitor and reboot.

Step 2 Verify the connection cable is good.

If there is still no image display on the monitor after rebooting, please check if the connection cable is good, and change a cable to connect again.

Step 3 Verify Input mode of the monitor is correct.

Please check the input mode of the monitor matches with the output mode of the device (e.g. if the output mode of DVR is HDMI output, then the input mode of monitor must be the HDMI input). And if not, please modify the input mode of monitor.

Step 4 Check if the fault is solved by the step 1 to step 3.

If it is solved, finish the process.

If not, please contact the engineer from our company to do the further process.

● **There is a beep sound after a new bought device starts up.**

Possible Reasons:

- No HDD is installed in the device.
- The installed HDD has not been initialized.
- The installed HDD is not compatible with the device or is broken-down.

Step 1 Verify at least one HDD is installed in the device.

- 1) If not, please install the compatible HDD.



NOTE

Please refer to the “Quick Operation Guide” for the HDD installation steps.

- 2) If you do not want to install a HDD, select “Menu>Configuration > Exceptions”, and uncheck the Audible Warning checkbox of “HDD Error”.

Step 2 Verify the HDD is initialized.

- 1) Select “Menu>HDD>General”.

- 2) If the status of the HDD is “Uninitialized”, please check the checkbox of corresponding HDD and click **Init**.

Step 3 Verify the HDD is detected or is in good condition.

- 1) Select “Menu>HDD>General”.
- 2) If the HDD is not detected or the status is “Abnormal”, please replace the dedicated HDD according to the requirement.

Step 4 Check if the fault is solved by the step 1 to step 3.

- 1) If it is solved, finish the process.
- 2) If not, please contact the engineer from our company to do the further process.

● **Live view stuck when video outputs locally.**

Possible Reasons:

- The frame rate has not reached the real-time frame rate.

Step 1 Check the parameters of Main Stream (Continuous) and Main Stream (Event).

Select “Menu > Record > Parameters > Record”, and set the resolution of Main Stream (Event) the same as the one of Main Stream (Continuous).

Step 2 Verify the frame rate is real-time frame rate.

Select “Menu > Record > Parameters > Record”, and set the Frame Rate to Full Frame.

Step 3 Check if the fault is solved by the above steps.

If it is solved, finish the process.

If not, please contact the engineer from our company to do the further process.

● **When using the device to get the live view audio, there is no sound or there is too much noise, or the volume is too low.**

Possible Reasons:

- Cable between the pickup and camera is not connected well; impedance mismatches or incompatible.
- The stream type is not set as “Video & Audio”.

Step 1 Verify the cable between the pickup and camera is connected well; impedance matches and compatible.

Step 2 Verify the setting parameters are correct.

Select “Menu > Record > Parameters > Record”, and set the Stream Type as “Audio & Video”.

Step 3 Check if the fault is solved by the above steps.

If it is solved, finish the process.

If not, please contact the engineer from our company to do the further process.

● **The image gets stuck when DVR is playing back by single or multi-channel cameras.**

Possible Reasons:

- The frame rate is not the real-time frame rate.
- The DVR supports up to 16-channel synchronize playback at the resolution of 4CIF, if you want a 16-channel synchronize playback at the resolution of 720p, the frame extracting may occur, which leads to a slight stuck.

Step 1 Verify the frame rate is real-time frame rate.

Select “Menu > Record > Parameters > Record”, and set the Frame Rate to “Full Frame”.

Step 2 Verify the hardware can afford the playback.

Reduce the channel number of playback.

Select “Menu > Record > Encoding > Record”, and set the resolution and bitrate to a lower level.

Step 3 Reduce the number of local playback channel.

Select “Menu > Playback”, and uncheck the checkbox of unnecessary channels.

Step 4 Check if the fault is solved by the above steps.

If it is solved, finish the process.

If not, please contact the engineer from our company to do the further process.

- **No record file found in the device local HDD, and the prompt “No record file found” pops up when you search the record files.**

Possible Reasons:

- The time setting of system is incorrect.
- The search condition is incorrect.
- The HDD is error or not detected.

Step 1 Verify the system time setting is correct.

Select “Menu > Configuration > General > General”, and verify the “System Time” is correct.

Step 2 Verify the search condition is correct.

Select “Playback”, and verify the channel and time are correct.

Step 3 Verify the HDD status is normal.

Select “Menu > HDD > General” to view the HDD status, and verify the HDD is detected and can be read and written normally.

Step 4 Check if the fault is solved by the above steps.

If it is solved, finish the process.

If not, please contact the engineer from our company to do the further process.

18.3 List of Applicable Power Adapter



NOTE

Use only power supplies listed in the user instructions.

Power Adapter Model	Specifications	Manufacturer
MSA-C1500IC12.0-18P-DE	12 V, 1.5 A	0000201935 MOSO Technology Co., Ltd.
ADS-25FSG-12 12018GPG	CE, 100 to 240 VAC, 12 V, 1.5 A, 18 W, Φ5.5 × 2.1 × 10	0000200174 Shenzhen Honor Electronic Co., Ltd.
MSA-C1500IC12.0-18P-US	12 V, 1.5 A	0000201935 MOSO Technology Co., Ltd.
TS-A018-120015AD	100 to 240 VAC, 12 V, 1.5 A, 18 W, Φ5.5 × 2.1 × 10	0000200878 Shenzhen Transin Technologies Co., Ltd.
MSA-C2000IC12.0-24P-DE	12 V, 2 A	0000201935 MOSO Technology Co., Ltd.
ADS-24S-12 1224GPG	CE, 100 to 240 VAC, 12 V, 2 A, 24 W, Φ2.1	0000200174 Shenzhen Honor Electronic Co., Ltd.
MSA-C2000IC12.0-24P-US	US, 12 V, 2 A	0000201935 MOSO Technology Co., Ltd.
ADS-26FSG-12 12024EPCU	US, 12 V, 2 A	0000200174 Shenzhen Honor Electronic Co., Ltd.
KPL-040F-VI	12 V, 3.33 A, 40 W	0000203078 Channel Well Technology Co., Ltd.
MSA-Z3330IC12.0-48W-Q	12 V, 3.33 A	0000201935 MOSO Technology Co., Ltd.
MSP-Z1360IC48.0-65W	48 V, 1.36 A	0000201935 MOSO Technology Co., Ltd.
KPL-050S-II	48 V, 1.04 A	0000203078 Channel Well Technology Co., Ltd.

0305371080920

