

# *User's Manual*

**VAST**  
Central Management Software

Rev.: 1.13



## **Table of Contents**

Revision History .....	8
<b>Getting Started .....</b>	<b>12</b>
Introducing VAST.....	12
New Features.....	12
Key Features.....	12
VAST Server and Client Components .....	13
Usage Scenario.....	13
Technical Specifications .....	14
VAST Server Functionality.....	16
VAST LiveClient Functionality .....	17
VAST Playback Functionality.....	18
Minimum System Requirements .....	19
VAST Software License.....	21
Reminders for VAST Software License .....	22
<b>VAST Installation .....</b>	<b>24</b>
Installing the VAST Software .....	24
<b>VAST Server.....</b>	<b>28</b>
Activating the VAST Server .....	28
How to Configure the Server .....	28
How to Stop/Reboot the Server.....	28
<b>VAST LiveClient Configuration .....</b>	<b>29</b>
Activating the VAST LiveClient and Logging in to a VAST Server.....	29
VAST LiveClient User Interface .....	31
Menu Bar.....	31
Status Panel.....	32
Help Panel.....	33
Quick Access Bar .....	34
Live Video Monitoring Window .....	34
Hierarchical Management Tree .....	35
Camera Control Panel.....	36
Pan/Tilt/Zoom (PTZ) Control Panel.....	36
Two Way Audio Control Panel.....	38
Language Selection .....	38
Alarm Window .....	39
Alarm Filter .....	40
Alarm State .....	41
Instant Playback.....	42
Instant Replay .....	43
Audio Control .....	44
How to Manage Devices .....	45

Insert Cameras.....	45
Seamless Recording .....	49
Enable SVC .....	52
Streaming URL.....	55
Insert NVR (Network Video Recorder) .....	56
Insert a Video Server.....	59
Update Devices .....	61
Delete Devices from the VAST Server .....	62
Batch Insert Devices .....	63
Camera Configuration .....	68
View Live Videos .....	73
Dual / Multiple Streams .....	73
Fisheye Display Modes .....	73
Refresh.....	78
Streaming Server .....	78
Output Camera List .....	78
Get Public IP .....	78
Camera Settings .....	79
Remove Live Video from the Video Monitoring Window .....	80
How to Change the VAST LiveClient Layout.....	81
Changing the Layout of the Live Video Monitoring Window.....	81
Switch Video Channels .....	81
Configure Layout Mode.....	82
Configure Layout Mode.....	82
Rotating Video Pages .....	84
Edit Layout .....	84
Scheduled Layout Rotation.....	86
Maximize/Minimize the Live Video Monitoring Window.....	90
View Live Video on Dual Monitors.....	91
Simultaneously Viewing up to 128 Channels.....	92
Using different layouts on each monitor.....	92
View Live Video with Multiple Monitors .....	93
How to Manage Stations .....	94
Relay Settings .....	94
Insert Sub-stations .....	95
Delete Sub-stations.....	98
Update Stations.....	99
How to Manage User Accounts .....	100
The Default User Roles and Permissions of User Accounts .....	100
Manage a User Account.....	102
Add a New User Account - Basic Account .....	102
Add a New User Account - Windows AD Account.....	103
Permission of the User Account .....	106
Delete the User Account .....	107
How to Set up Association Management.....	109
Association Management.....	109

How to Set up Alarm Management.....	111
Alarm Management.....	111
How to Manage the Virtual Matrix .....	122
The architecture of VAST Matrix .....	122
Installing VAST Matrix Program .....	123
Launching VAST Matrix.....	124
Configuration.....	125
View Settings .....	125
About.....	125
Exit .....	125
VAST Matrix Management .....	126
Matrix Management Settings .....	126
Manage VAST Matrix through VAST LiveClient .....	128
Matrix View Settings.....	129
Search VIVOCam Switches .....	132
How to Configure the Station General Settings.....	133
Server Settings.....	133
Log Settings .....	133
How to Configure Station Network Settings .....	134
Port Settings.....	134
UPnP Settings.....	134
Proxy Settings .....	134
Web Access Settings.....	134
How to Edit Recording Groups.....	135
Recording Storage Settings .....	135
Default Storage Group Settings .....	136
Add New Recording Group(s).....	138
Multiple Stream Recording.....	139
How to Edit Recording Schedules.....	141
Edit Schedule List .....	142
Add Schedules.....	142
Rename Schedules.....	142
Delete Schedules .....	142
Load/Save Schedule Templates.....	143
Edit Camera List.....	144
Edit Time Frame List .....	145
Add New Time Frames.....	146
Recording Settings.....	147
The Concept of Repeat Frequency .....	149
Repeat Frequency: Daily Setting .....	150
Repeat Frequency: Weekly Setting (Day-based).....	153
Repeat Frequency: Monthly Setting (Day-based).....	156
Repeat Frequency: Yearly Setting (Day-based).....	158
How to Manually Begin /Stop Recording .....	160
How to Edit Scheduled Backup Settings .....	161
Select Backup Source .....	161
Setup Backup Schedule.....	162
Select Backup Target .....	162

How to Configure Station Server Settings .....	163
DDNS Settings .....	163
Network Storage Server Settings .....	164
SMTP Settings .....	165
How to Use the Talk Panel .....	166
Add a Camera to the Talk Panel.....	166
Remove a Camera from the Talk Panel .....	168
How to Configure E-map Settings .....	169
Upload an E-map .....	169
User Interface of E-map Settings Page (View Mode).....	170
Quick Access Bar .....	171
Status Panel.....	171
User Interface of E-map Settings Page (Edit Mode) .....	172
Device Management .....	173
Live View Dialog Settings.....	174
Open Live View Dialog.....	174
Send to Single View .....	174
E-map Link .....	175
How to Configure Client Settings .....	179
Snapshot Settings .....	179
Take a Snapshot .....	180
Recording Settings .....	181
Type 1: Record to EXE .....	181
Type 2: Record to 3GP.....	181
Type 3: Record to AVI .....	182
Built-in Media Player--EXE.....	185
View Settings.....	187
Display Location.....	187
Date and Time Format .....	188
Video Display Mode .....	188
Font Settings .....	189
General Settings .....	190
System Settings .....	190
Alarm Settings.....	191
Rotation Settings.....	192
Display Settings .....	193
Joystick Settings .....	195
Enable Joystick .....	195
Joystick Settings - Using VIVOTEK's AJ-001 & AJ-002 .....	201
Proxy Settings .....	205
How to Use PiP (Picture-in-Picture) .....	206
Enable PiP.....	206
Global View .....	206
ROI (Region of Interest).....	207
Digital Zoom In.....	207
Snapshot & Print Zoomed In Image .....	207
PiP Settings.....	207
Multi-touch Mode.....	208

How to Configure Video Enhancement .....	209
Basic Image Adjustment.....	209
Defog.....	211
Apply a Preset Defog Profile .....	211
Create a New Defog Profile .....	212
How to Search for a Device on the Hierarchical Management Tree .....	214
How to Print a Video Image.....	215
How to Lock LiveClient for Security Concerns .....	215
How to Log out from the VAST Server .....	216
How to Exit VAST LiveClient .....	216
How to Configure a Logical Tree .....	217
<b>VAST Playback Configuration .....</b>	<b>224</b>
Activating VAST Playback and Logging in to a Server.....	224
VAST Playback User Interface .....	225
Menu Bar.....	225
Status Panel.....	225
Quick Access Bar .....	226
Recorded Video Playback Window .....	226
Language Selection .....	227
Query Panel-- Browsing Page.....	227
Query Panel--Time Search Page .....	229
Query Panel--Event Search Page.....	230
Query Panel--Bookmark Search Page.....	231
Query Panel--Alarm Search Page.....	232
Query Panel--Log Viewer Page.....	233
Video Clips List Window.....	234
Playback Control Panel.....	235
Rewind .....	236
How to Playback Recorded Video .....	237
Select a Recorded Video Clip .....	237
Remove Recorded Video Clips from Video Cells.....	240
Timeline Slider Bar and Histogram.....	240
Zoom in / out of the Histogram.....	241
Synchronous Playback.....	242
Audio Control .....	244
How to Change the Playback Layout .....	245
Changing the Layout of the Recorded Video Playback Window .....	245
Switch Video Channels .....	245
Configure Layout Mode.....	245
Maximize/Minimize the Recorded Video Playback Window.....	246
View Recorded Video with Multiple Monitors .....	247
How to Backup Recorded Video .....	248
How to Search for a Video Clip in a Specific Period of time.....	254
How to Add a Bookmark.....	255
How to Search for Events.....	256
Select Event Category .....	257
Event Category- All Events .....	257

Event Category- All Motion Events.....	257
Event Category- All IVA events .....	258
Event Category- All DI Events.....	258
Event Category- Named DI Events .....	259
Start Event Search .....	260
Backup the Event Videos .....	261
How to Search for a Bookmark .....	262
How to Search Logs .....	263
Select Log Category/Log Type/Log Level .....	264
Search All Local Logs.....	265
Search Login History.....	265
Search Login Activities .....	266
How to Configure Client Settings .....	268
Snapshot Settings .....	268
Export Settings.....	268
View Settings.....	270
Proxy Settings .....	270
General Settings .....	270
System Settings .....	270
Display Settings .....	270
How to Configure Video Enhancement .....	270
How to Search for a Device on the Hierarchical Management Tree .....	270
How to Print a Video Image.....	270
How to Lock VAST Playback for Security Concerns .....	271
How to Log out from the VAST Server .....	271
How to Exit VAST Playback.....	271
<b>Import and Export Utility .....</b>	<b>272</b>
Export Utility .....	272
Import Utility .....	272
<b>VAST Service Control Tool .....</b>	<b>274</b>
<b>Appendix A Failover Server Configuration.....</b>	<b>275</b>
Failover Configuration Process .....	283
<b>Appendix B Panoramic PTZ (P-PTZ) Configuration.....</b>	<b>288</b>
Enable Panoramic PTZ on VAST .....	288
Panoramic PTZ - Event Trigger .....	291
Enable or Disable the Panoramic PTZ Functions .....	293
<b>Appendix C ONVIF Support .....</b>	<b>294</b>
<b>Appendix D VCA Report.....</b>	<b>296</b>
<b>Appendix E Support for Digital I/O Modbus TCP Modules .....</b>	<b>307</b>
<b>Appendix F Database Merge Function .....</b>	<b>312</b>
<b>Appendix G Other Parameters .....</b>	<b>318</b>

## Revision History

### Rev. 1.5.2:

- \* VAST now supports Video Servers VS8801 & VS8401, and NVR servers NR8201 & NR8301.
- \* Automatically saves the last layout when the management session is closed (for both LiveClient and Playback).
- \* Added Playback as one of user's privilege options.
- \* A web session with an individual camera can be launched by a double-click on a camera's icon.

### Rev. 1.6.1:

- \* Added description for Adaptive Frame Rate Adjustment with the new SVC codec cameras.
- \* Added description for Auto Stream Size functionality.
- \* Added functionalities related to FE8171V fisheye camera.
- \* Added description for fisheye-specific screen control and playback functions.
- \* Replaced some description for the changes/improvements made on the user interface.
- \* Modified the graphic size limitation of E-map upload from 5MB to 2MB.

### Rev. 1.6.18:

- \* Corrected editorial errors and added a conceptual drawing for the SVC-T (Temporal) function.

### Rev. 1.6.1.11:

- \* Changed the maximum number of channel number in trial mode to 256.

### Rev. 1.7.7:

- \* Added description for the Bookmark function.
- \* Added functional description related to the Panoramic PTZ feature in Appendix A.
- \* Added description for the Instant Replay function.
- \* Reflected changes on the new display and layout design.
- \* Added Hot key combinations.
- \* Removed the 1P3R fisheye display mode, which was removed from specifications later.

### Rev. 1.8:

- \* Added individual Motion detection window options in the Event Management configuration (see page 112).
- \* Added description for new Export video clips function.
- \* Added support for user accounts from Windows AD (Active Directory) service. (see page 103).
- \* Added G.726 audio codec support.



- \* Added digital input options in the Recording Schedule settings. (see page 148)
- \* Added contents for the support of ONVIF rev. 2.2 in Appendix D (see page 294).
- \* Added new PTZ control options (speed and continuous move) for speed dome cameras. (see page 37).
- \* Added description for the Seamless Recording function. (see page 49).
- \* User management: increased the number of configurable users to 1,024.
- \* Added the Device Pack update option (see page 33).

#### Rev. 1.9:

- \* Renamed and re-organized the Event Management window into the Alarm Management windows. The Filter function is added. (see page 112).
- \* Added description for the vertical layouts. (see page 82).
- \* Added description for the Video mode option (see page 68).
- \* Added description for the common user name and password for multiple cameras (see page 67).
- \* Added the Sort devices by name option (see page 191).
- \* Added Storage lost as a system log type.
- \* Added description for the Alarm search function (see page 232).
- \* Added Appendix D for the I/O box support (Digital I/O Modbus TCP Modules). (see page 307).
- \* Added the Auto tracking button (see page 36).
- \* Added description of the new implementation for multiple event screens on video alarms (see page 117).

#### Rev. 1.10:

- \* Added the ONVIF Batch Insert feature (see page 63).
- \* Added the show VCA rules setting in View settings (see page 188). Note that VCA rules are not displayed on the Matrix view.
- \* Added information for the Logical Tree configuration (see page 217).
- \* Added the video clip information - resolution/codecs/fps/model name/IP/throughput.
- \* Added the feature for enabling/disabling Server GUID while importing VAST configuration. (see page 272).
- \* Moved Appendix D ONVIF support to page 294. Moved Appendix E Digital I/O Modbus TCP Modules to page 307.
- \* Added Line Crossing and Field Detection as the triggering conditions in Recording Schedule setting.
- \* Added the Output Camera List function on a right-click menu (see page 78).
- \* Removed the Video settings from the Batch Insert function window.
- \* Modified the Activity Adaptive streaming (Recording Settings) on page 47.

Rev. 1.11:

1. Described the application rules for the new software license. The new software license replaces the use of hardware dongle. The same software licenses apply to both VIVOTEK cameras and ONVIF cameras. [See page 21 for details.](#)
2. Added enhancement details for the Alarm state function group. [See page 41.](#)
3. Added H.265 codec support for the latest H.265 models.
4. Added description for the new device pack update function. The older Linux-based NVRs (NR8201/NR8301/NR8401) and ND8301/ND8401 do not support this function.
5. Added joystick related configuration options, such as keypad quick switch, channel mapping, and zoom control direction. [See page 200.](#)
6. Added description for the improved Instant Replay. [See page 43.](#)
7. Added information about the support for VIVOTEK's managed switches. [See page 132.](#)
8. Added the options for Disable Background Decode ([see Appendix E on page 318](#)), DI/DO status detection, and storage directory reserved space (10%).
9. Added Email with snapshot in the Alarm Management window. [See page 115.](#)

Rev. 1.12:

1. Improved displays of alarm windows with better display layout. The Alarm notification windows can display the dewarped regional views for fisheye cameras. Also, the Alarm search results can be exported to csv files. [See page 120.](#)
2. Added support for SSL management session with HTTPS login. [See page 30.](#)
3. Supports Multiple Stream Recording for recording redundancy. Different recording schedules apply to different recording streams. [See page 138.](#)
4. Supports Seamless Recording of VCA counting data.
5. Supports configurable user access time and login time limitations (Expiration). [See page 108.](#)
6. Supports multicast streaming for Virtual Matrix. [See page 130.](#)
7. Added the description for VCA People Counting Report utility in Appendix D. [See page 296.](#)
8. Supports SQLite since rev. 1.12. The related information will display when updating the VAST software.
9. Added description for the Database Merge function in Appendix F for migration of recording files across systems. [See page 312.](#)

Rev. 1.13:

1. Added Failover server configuration as the Appendix A. [See page 275.](#)
2. Supports bad block/life expectancy event notification from SONY's Smart SD card. [See page 114.](#)
3. Supports Alarm configuration using the DI/DO triggers from VIVOTEK's sub-station cameras and NVR systems. [See page 111.](#) NVR DI/DO on page 56.
4. Added the description for pop-up alarm windows on E-maps. [See page 191.](#)
5. Added the description for adding cameras using the URL command. [See page 55.](#)
6. Added the description for overlay camera name and time on snapshots. [See page 179.](#)
7. Added the description for VIVOTEK joystick function integration. [See page 201.](#)
8. Added the description for the Scheduled Backup enhancement. [See page 161.](#)
9. Added the description for the User List Export function. [See page 108.](#)

10. Added the description for the Scheduled Layout Rotation function. [See page 86.](#)

11. Added description for the Seamless Recording status. [See page 49.](#)

This revision also supports Auto Stream Size for Matirx.

## Technology License Notice



### Notices from HEVC Advance:

**THIS PRODUCT IS SOLD WITH A LIMITED LICENSE AND IS AUTHORIZED TO BE USED ONLY IN CONNECTION WITH HEVC CONTENT THAT MEETS EACH OF THE THREE FOLLOWING QUALIFICATIONS: (1) HEVC CONTENT ONLY FOR PERSONAL USE; (2) HEVC CONTENT THAT IS NOT OFFERED FOR SALE; AND (3) HEVC CONTENT THAT IS CREATED BY THE OWNER OF THE PRODUCT. THIS PRODUCT MAY NOT BE USED IN CONNECTION WITH HEVC ENCODED CONTENT CREATED BY A THIRD PARTY, WHICH THE USER HAS ORDERED OR PURCHASED FROM A THIRD PARTY, UNLESS THE USER IS SEPARATELY GRANTED RIGHTS TO USE THE PRODUCT WITH SUCH CONTENT BY A LICENSED SELLER OF THE CONTENT. YOUR USE OF THIS PRODUCT IN CONNECTION WITH HEVC ENCODED CONTENT IS DEEMED ACCEPTANCE OF THE LIMITED AUTHORITY TO USE AS NOTED ABOVE.**

# Getting Started

## Introducing VAST

VIVOTEK VAST is the professional video / central management software designed for managing all VIVOTEK IP surveillance products with intuitive functions and numerous features. It supports hundreds of cameras and stations in a hierarchical structure of system for monitoring, recording, playback and event trigger management with ease-of-use and efficient control. Moreover, VAST also offers the video wall solution, VAST Matrix, for hundreds of cameras live view monitoring.

VAST integrates VIVOTEK network cameras to provide diverse solutions and applications, such as seamless recording with the cameras for uninterrupted video recording and Panoramic PTZ for 360° seamless surveillance solution. VAST performs remote management with full range of the server & client structure and constitutes a robust system for various applications, such as stores, banking and the public space.

## New Features

- H.265 compression support
- Multiple Stream Recording
- VCA Counting Report
- HTTP Secure Connection Support
- Multicast Support (Matrix Only)
- User Management Enhancement

## Key Features

- 128-channel Live Video Monitoring with Dual Monitors
- 16-channel Synchronous Playback
- Video Wall Solution “VAST Matrix” for Unlimited Live Views
- Auto Stream Size for Reducing Display Loading
- Instant Replay & Playback on Live Client
- Intelligent Alarm Management and Acknowledgement
- Overall Device Management through Intuitive E-map Feature
- Multiple Fisheye Dewarp Support
- Web Access via Internet Explorer
- Logical Tree Management
- Windows Active Directory Integration
- VIVOTEK Exclusive Feature: Panoramic PTZ, Seamless Recording and VCA Counting Solution

\* The number of linked devices will depend on the license on the key dongle.

\* The ability to extend devices is also subject to the network bandwidth and computer performance.

## VAST Server and Client Components

There are four components in VAST: one server component--VAST Server, three client components--**VAST LiveClient**, **VAST Playback**, and **VAST Matrix**.

**VAST Server** provides a centralized management site for video recording. **VAST LiveClient** is a client program for the user to login and modify the server's configuration, edit the server's recording storage, schedules and many other functions on the server; **VAST Playback** is another client program for the user to log in and browse the recorded video database and video clips related to specific events on the server.

## Usage Scenario

The powerful management scalability of VAST makes it suitable for managing small- to large-scale structures.

For users that manage only a few cameras, we recommend installing the client and server components on the same computer. A host with all of the three components installed is recognized as a stand-alone site. All the functions can be simultaneously performed on one single site.

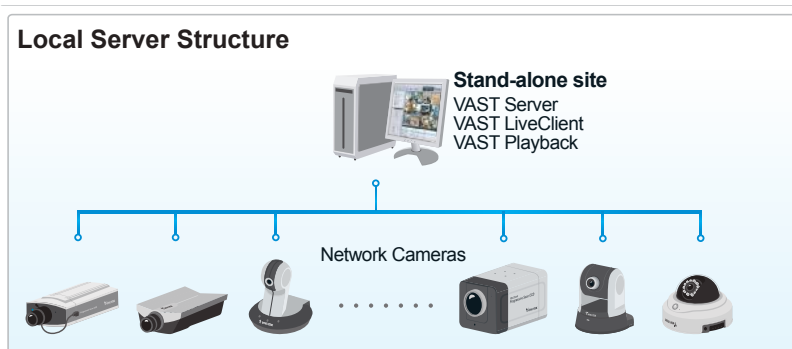

For users who manage large-scale surveillance deployments, please plan the hierarchical structure first. Then you can start to add cameras to each station and connect these sub-stations to the root station. The whole hierarchical management system is thus constructed.

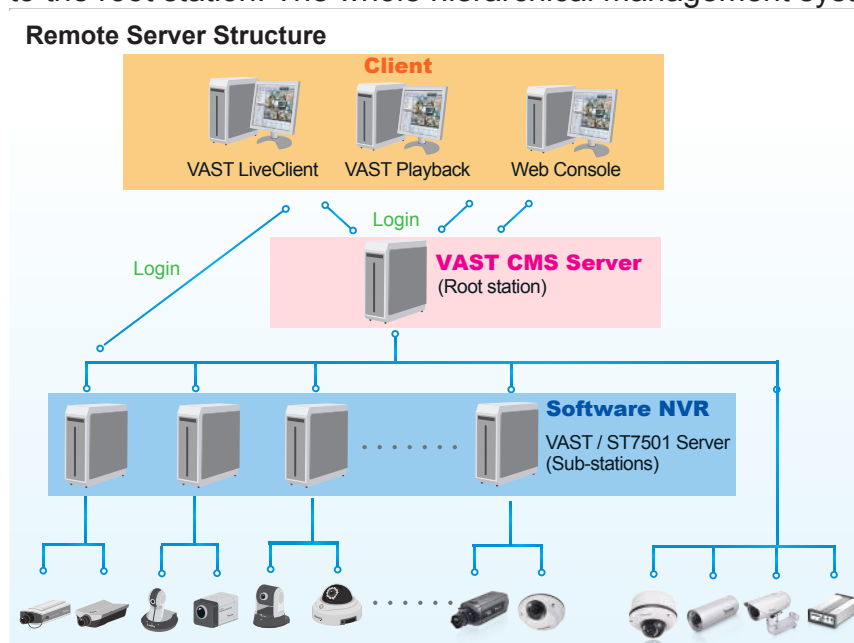

Please refer to page 217 for Logical Tree configuration, which allows for a flexible and user-oriented privilege control.

## Technical Specifications

Version	1.12
<b>General</b>	
Max. Number of Cameras*	Unlimited
Max. Number of Servers*	Unlimited
Max. Number of Clients	Unlimited
Support OS	Windows 8, 7, Vista, XP Windows Server 2012, 2008, 2003, 2000
Support Web Browser	Internet Explorer 11/10/9
Mobile Support	iViewer (iOS/Android)
Virtual Matrix Support*	VAST Matrix
Devices Pack	.vdp File Update
*Please refer to System Requirements Page ( <a href="http://www.vivotek.com/vast/#system">http://www.vivotek.com/vast/#system</a> )	
<b>LiveView (Local Display)</b>	
Max. Channel	128-Channel (with Dual Monitors)
Layout	Multi Layout Display: 1x1, 2x2, 1+5, 3x3, 1+12, 4x4, 5x5, 1+31, 8x8, 1P+2, 1P+6, 1P+8, 2V, 3V, 4V, 2V+3 Single Layout Display, Full Screen Display, Sequential Display
Stream Application	Stream Selection & Auto Stream Size
View Application	Drag & Drop Remote I/O Control PiP (Digital Zoom) Instant Replay De-interlace Video Display Mode (Aspect Ratio, Hide Borders, Keep Top/Down Borders)
Fisheye Dewarp Mode	Fisheye Display Mode: Regular: 1O, 1P, 1R, 1O3R, 4R Wall Mount: 1P2R, 1P3R Ceiling/Floor Mount: 2P, 4R Pro, 1O8R
<b>Playback</b>	
Max. Channel	16 Channels
Layout	Multi Layout Display: 1x1, 2x2, 1+5, 3x3, 1+12, 4x4, 2V, 3V, 4V, 2V+3 Single Layout Display, Full Screen Display, Sequential Display
Playback Mode	Asynchronous & Synchronous
Playback Control	Play, Rewind, Pause, Stop, Next/Previous Video Start, Next/Previous Frame, 1/8X ~ 64X Speed Control, Bookmark
Search Mode	Browsing, Date & Time (Fast), Event, Bookmark, Alarm, Log, Timeline, Timeline Scale
<b>Video</b>	
Video Format	MJPEG, MPEG4, H.264 AVC, H.264 SVC, H.265
Video Resolution	Up to 9 Megapixels
Video Enhancement	Basic Mode: Brightness, Contrast, Saturation, Hue Intelligent Mode: Defog, Rain, Snow, Fire/Smoke
<b>Audio</b>	
Audio Format	G.711, G.726, AMR, AAC
Audio Capability	Two-way Audio

Audio Control	Mute, Broadcasting & Sound Play
<b>Record</b>	
Recording Time (sec.)	Pre-Record: 3-15, Post-Record: 10-60
Recording Stream Type	Unicast
Recording Stream	Single/Multiple
Recording Mode	Continuous, Schedule, Manual, Event, Activity Adaptive Streaming
Recording Setting	Recycle (Unit: Size or Day)
Recording File Format	3GP
External Storage Recording	NAS (SMB & CIFS)
<b>Alarm Management</b>	
Alarm Period (sec.)	Max. 30
Alarm Filter	Name, Time, Source, Event Type, State
Alarm Setting	LiveView Alarm Notification: Fixed & Popup Alert Sound
Schedule Type	Continuous, Schedule, Manual
Camera Event	Motion, DI/O, Video Lost/Restore, PIR, Tampering, Temperature, IR, PPTZ, Line Crossing Detection, Loitering Detection, Field Detection
Camera Status	Connection Status, Recording Status, Recording Error
Substation	Substation Connection Status
Storage Status	Storage Connection Status, Storage Capacity Status
Station Status	License Status, Network Status, Virtual Memory Status
External Devices Event	DI/O (With I/O Box)
Action	Email, Start Recording, Move to preset location, Set DO, GSM Short Message, HTTP & Client notification
Alarm State for Management	New, Assigned, In Progress, Resolved, Closed, Later, Reject, Ignore
Alarm Result Export	.csv File
<b>eMap</b>	
Source	Import Picture
Marked	Add, Remove, Direction Control, PTZ Control & Indicator LiveView
Event Notification	Event Icon Light Flash
<b>PTZ</b>	
PTZ/ePTZ Control	Panel Control & Mouse Click Control
PTZ/ePTZ Operation	Direction Control, Home, Zoom, Focus, Iris, Preset, Patrol (Group), Pan, Stop, Speed
PTZ Operation Mode	Click to Move & Continuous Move
<b>Export</b>	
Print	Selection Windows & All Windows
Snapshot	BMP & JPEG
Export File	AVI, 3GP & EXE

## Technical Specifications

<b>Backup</b>			
Schedule	NAS (SMB & CIFS)	Connection Setting	Configuration Protocol: HTTP, HTTPS Streaming Protocol: TCP, UDP, HTTP, HTTPS
<b>User Management</b>		Video Setting	Video Stream, Compression, Resolution, FPS, Video Quality
Authentication	Basic Account/Windows AD Account	Audio Setting	Compression & Bitrate
User Level	Administrator, Power User, User, Operator & Guest	Remote Focus	Manual Focus Adjustment & Full Range Scan
User Control	Permission, Accessible Cameras & Substations	NTP Setting	IP Address (NTP Server or VAST Server) & Updating Interval
User Login Time Limitation	By Time & By Day	ONVIF Core Spec	Version 2.2 or above (By Project)
User Login Schedule	Weekly Setting	ONVIF Stream	Video (H.264, MPEG4 & MJPEG) & Audio (G.711, One Way)
<b>System</b>		ONVIF Control	PTZ Control (Up, Down, Left, Right & Zoom In/Out)
Date & Time	Sync PC	ONVIF Discovery	Discover the other brand camera through Insert Camera & Batch Insert
Network	DDNS, SMTP, UPnP, Proxy, HTTPS	<b>VCA Solution</b>	
Multicast	Matrix Only	VCA for Surveillance	Motion Detection, Line Crossing
Language	Czech, English, French, German, Italian, Japanese, Persian, Portuguese, Russian, Spanish, Simplified Chinese, Traditional Chinese	VCA for Business Intelligence	People Counting
<b>Device Integration</b>		VCA Event	Line Crossing Detection, Loitering Detection, Field Detection
Joystick	VIVOTEK USB Joystick All Windows® Compatible USB Joystick	*Only Support VIVOTEK Cameras.	
Switch	VIVOTEK AW-GEV Series (VivoCam PoE Switch)	<b>Advanced Features</b>	
I/O Box	Advantech ADAM-6000 Series	VIVOTEK Exclusives	Panoramic PTZ Seamless Recording Standard VCA Integration (Line Crossing & Loitering & Field Detection) VCA Counting Solution
<b>Camera Integration</b>			
Camera Insert	Manual & Search		
Basic Setting	User Name, Password & Camera Model Detection		

## VAST Server Functionality

- Centralized management site for all the logged in clients
- Maintain the configuration of the hierarchical management list
- Hundreds of video recording channels
- Store recorded data onto multiple networked or local hard disks
- Live video for the local/remote LiveClient users
- Retrieval of recorded video for the local/remote Playback users
- Zero latency database recovery
- Multiple stream recording

LiveClient is the management interface to your VAST server. The server-related settings are made via the VAST LiveClient utility. The convenient and intuitive user interface on VAST LiveClient provides access to camera, live monitoring, and recording configurations.



## VAST LiveClient Functionality

- Server function control
  - Hierarchical station management
  - User account management
  - Recording storage management
  - Recording schedule management
  - Recorded data backup
  - Event trigger management
- Flexible video live view layout
  - Dual screens for a maximum of 64 or more channels for simultaneous monitoring
  - 1x1, 2V, 1P+2, 3V, 2x2, 4V, 2V+3, 1+5, 1P+6, 3x3, 1P+8, 1+12, 4x4, 5x5, 8x8, 1+31 monitoring layouts (V stands for vertical layout)
  - 1P+2, 1P+6, and 1P+8 Panoramic PTZ layouts
  - Multiple video viewing pages
- Virtual Matrix for video wall display
- Intelligent PiP function
- E-map for overall management
- Network storage for recorded video
- Convenient switching among multiple monitors
- PTZ / E-PTZ operation panel for camera control
- Supports two way audio
- Instant playback for event recording
- Instant replay for immediate playback
- Supports joystick control
- Remote configuration for network cameras

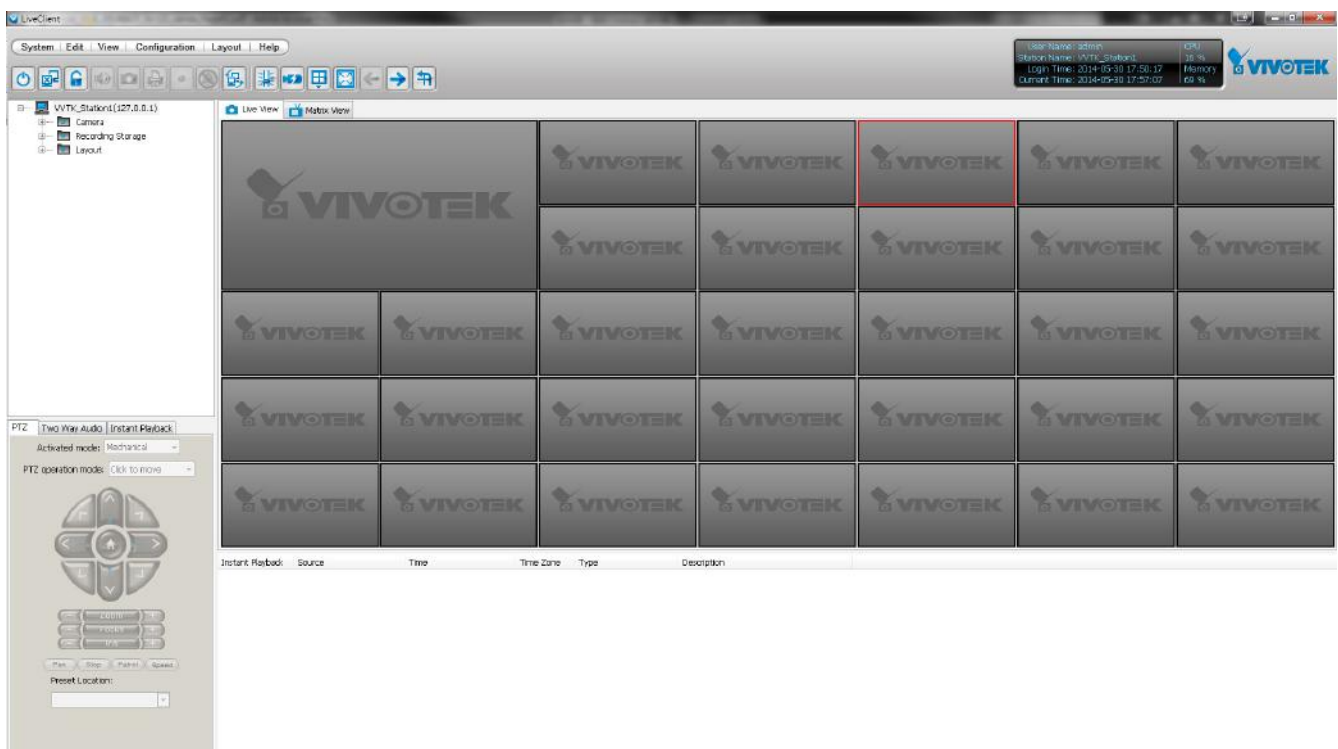

## VAST Playback Functionality

- Browse the database of recorded video from the server
- Flexible video playback layout
  - Maximum 16 channels with simultaneous playback
  - 1x1, 2V, 3V, 2x2, 4V, 2V+3, 1+5, 3x3, 1+12, 4x4 video playback layouts
- Supports powerful playback functions
  - 1/8x, 1/4x, 1/2x slow-down playback
  - 2x, 4x, 8x, 16x, 32x, 64x video playback speed
- Intelligent PiP function
- Supports convenient evidence and data exporting
  - Export media files of recorded video
  - Supports snapshot and print out
- Supports convenient switch among multiple monitors
- Search engine:
  - Time search
  - Event search
  - Bookmark search
  - Alarm and Log search
  - Alarm search result export
- Playback while recording
- Support synchronous/ asynchronous playback



## Minimum System Requirements

Before installing the VAST software, please make sure your system meets the following recommended minimum system requirements.

If you would like to install ST7501 Server only, please follow the requirements as below:

Server		
Operating System	Windows Server 2000, 2003, 2008, 2012 / Windows XP Professional, Windows 7, Windows 8	
Recording Channels (4Mbps per CH)	up to 64 CH (256Mbps throughput)	Up to 128CH (512Mbps throughput)
CPU	3rd Generation Intel® Core™ i5 Processors or above	3rd Generation Intel® Core™ i7 Processors or above
RAM	4GB or above - 64CH; 8GB or above - 128CH	
Network Interface Card	Ethernet, 1 Gbit recommended	
Graphics Adapter	DirectX 9 compatible 1GB graphics card	
Hard Disk Type	Single recording group w/ one HDD   Two recording group w/ two HDDs* SATA, SCSI, SAS (7200 rpm or faster) in NTFS format	

\* Each recording group can receive recordings for 60 channels.

If you would like to install both the server and client programs, please follow the requirements as below:

LiveClient and Playback				
Operating System		Windows Server 2000, 2003, 2008, 2012 / Windows XP Professional, Windows Vista, Windows 7, Windows 8		
Clients (Display Channels)	720P,4Mbps, H.264*	8CH	16CH	32CH
	1080P,4Mbps, H.264**	4CH	10CH	18 CH
	1080P,4Mbps, H.265	2CH	5CH	9CH
CPU	3rd Generation Intel® Core™ i3 Processors	3rd Generation Intel® Core™ i5 Processors	3rd Generation Intel® Core™ i7 Processors	
RAM	2 GB or above	4GB or above	4GB or above	
Network Interface Card		Ethernet, 1Gbit recommended		
Graphics Adapter		DirectX 9 compatible 1GB graphics card		

\* Display requirements of the 3MP fisheye camera is equal to a 720P camera.

\*\* Display requirements of the 5MP fisheye camera is equal to a 1080P camera.

If installing Server and Client on the same PC, the overall loading on the PC is to be evaluated.



- *Only users with Administrator privileges can install or use VAST on a Windows Vista system.*
- *The required hard disk space will depend on the video settings, the number of network cameras and recording group settings. Please add more hard disks if you want to extend the system.*  
*Below are approximate numbers for a week-long recording. The actual storage space required also depends on imaging parameters, e.g., a complex retail environment that involves many moving objects requires more pixel data to be transmitted over network than a simple environment such as a parking lot.*  
*32-CH, VGA, about 1 week recording: 750 GB*  
*64-CH, VGA, about 1 week recording: 1TB x 2*  
*32-CH, 2-megapixel, about 1 week recording: 2TB x 2*  
*64-CH, 2-megapixel, about 1 week recording: 2TB x 4*

## VAST Software License

To activate the software, refer to the flow chart below:

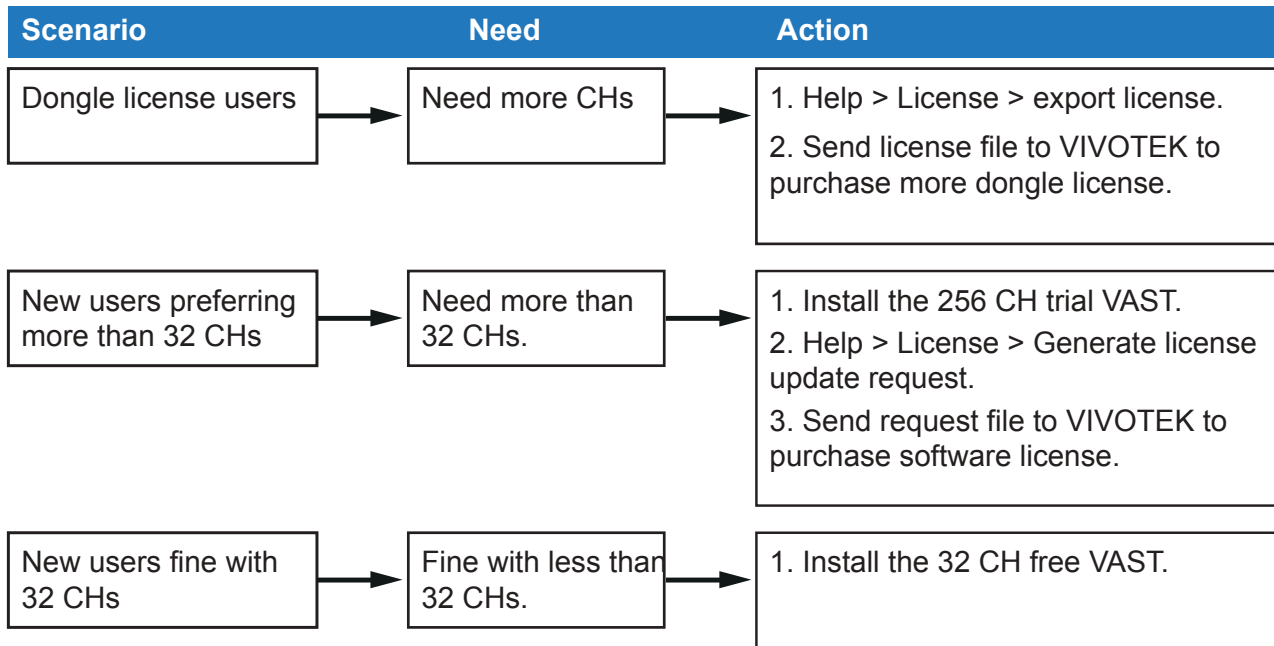

The VAST software provides 32 free channels. Since revision 1.11, the VAST software is activated using a software license instead of the original hardware dongle.

For users running the previous dongle version, there is no need to upgrade their original license. If they need the license for more channels, They can export their license file, and purchase more dongle licenses.

For users who require more than 32 channels, they can install the 256 channel trial version first, and go to **Help > License** page, and click on **Generate License Update Request**. Send the request back to VIVOTEK to purchase more channel licenses.

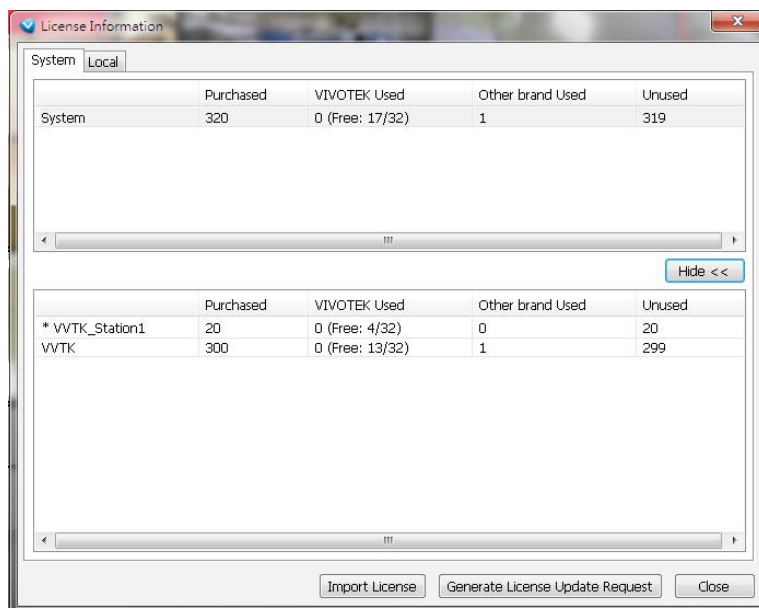

When you purchased and received the official software license, use the **Import License** function to activate the official license.

When importing purchased licenses, you can manually select which station/license file to update, or click the **Auto Dispatch** button and let system decide the distribution of license updates especially when there are substations under a managing VAST server.

Before the Auto Dispatch function is available, license has to be individually updated on every substations.

## Reminders for VAST Software License

### ■ Limitations:

1. The Batch import/export function applies when a managing VAST server needs to collect and update the licensing information from subordinate VAST substations and itself. An enterprise may have a central management server and several VAST instances running in branch offices. In that case, the substations will be listed on the device list, and may not be displayed on a hierarchical structure.

The Batch import/export function is accessed through the **Help > License** menu on LiveClient.

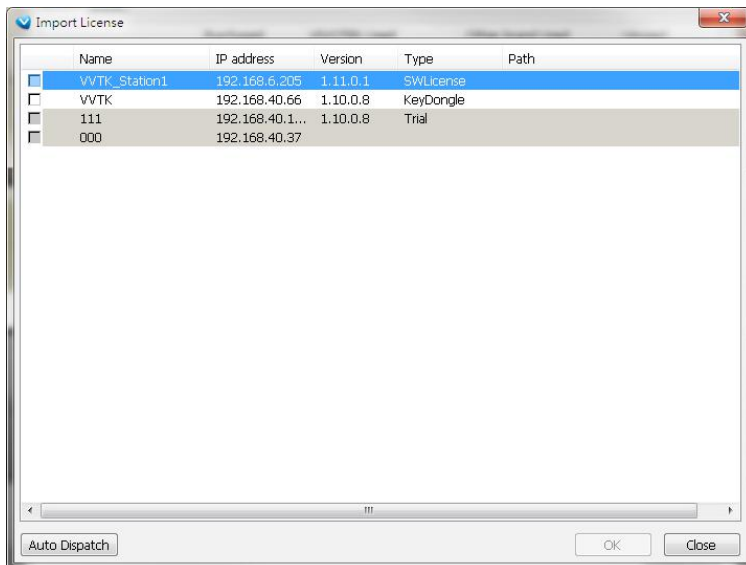

2. The batch download/import function only takes effect on a VAST instance running on server, not on the Linux-based NVR.
3. The trial channels on VAST substations will not be available for use on a managing VAST server (one that manages multiple substations).
4. If you access a VAST deployment via a web console, the license related information will not be available.
5. In this revision, an identical software license applies to both VIVOTEK and other-brand cameras (ONVIF). You do not need to activate two different kinds of software licenses.
6. The Batch export update of the current license profile is supported.
7. The licensing mechanism does not apply to machines running Virtualized OSes (**VMWare, VirtualBox, Hyper-V, Parallels**), either through an upgrade or generating software license on a new installation.
8. If VAST is removed and then re-installed, the number of licensed channels remains intact.
9. If users plan to integrate the software licenses from previous dongle licenses, problems may occur if users changed the exported license file name.

10. The VAST rev. 1.11 supports 32 free channels, and trial licenses for up to 256 channels. Note that the unused trial licenses in a VAST substation will not be available for a managing VAST server. The 32 free licenses will be available for a stand-alone VAST server only.
11. The software license verifies its availability on a machine by checking the computer's main components, e.g., GPU or memory. If a VAST server has several of its main components replaced, the software license may become invalid. Note that users can only change 2 components on a substation (server components - CPU/Memory/Graphics card/Network card/Main board).
12. For an older VAST installation containing a VAST substation licensed through the dongle, the 32 free channels will be automatically added to the total number of licensed channels. One substation comes with 32 free channels. The added number of licensed channels will become available for the managing VAST server.

# VAST Installation

## Installing the VAST Software

1. Run **VAST\_Setup.exe** on your computer. Select the displayed language. Click **I ACCEPT** the License Agreement and specify a location to install the program.

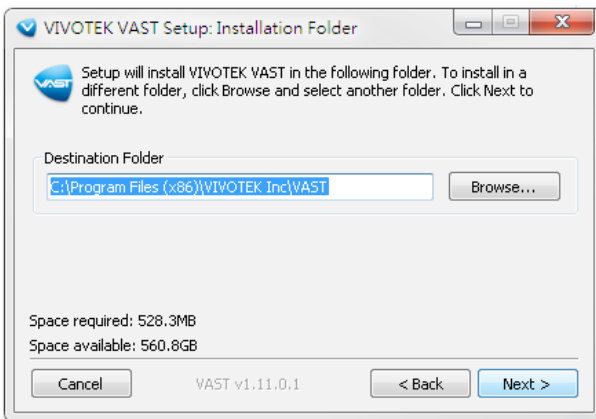
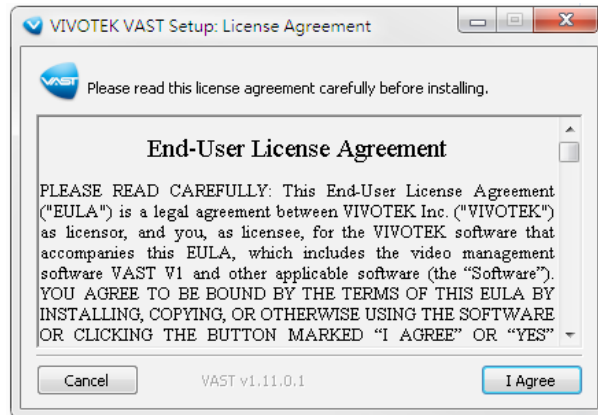

2. Select the items you want to install, then click **Next** to continue.

- If you want to install both VAST Server component and Client components, please follow the steps below to install the database.

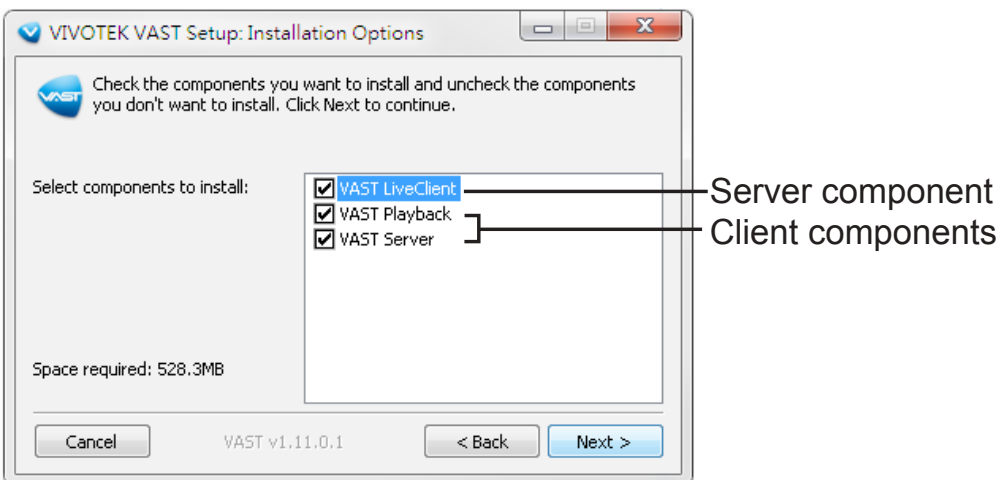



3. You can install the free 32 CH version, or, select the Trial 256 CH version, then click **Next** to continue.
  - The trial version will expire after 60 days. You can then contact VIVOTEK's sales representatives to purchase the official software license to continue using the software.

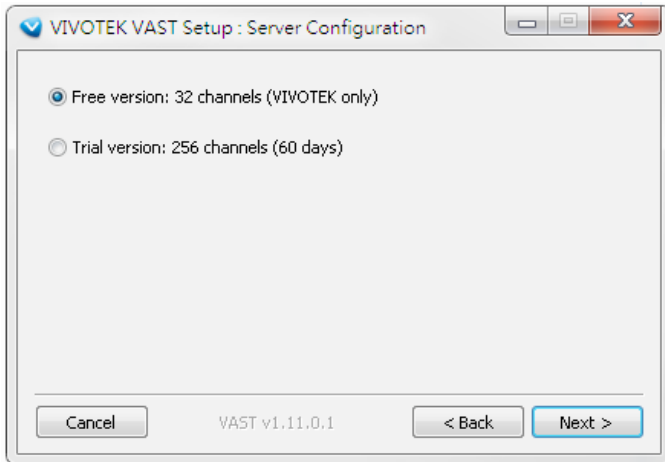

In the LiveClient window, you can go to **Help > License**, and click on **Generate License Update Request**. You can send the request file to VIVOTEK's sales representatives to facilitate the purchase process.

4. Assign a **username** and **password** for the VAST Server and click **Next** to continue. A strong password is recommended using a minimum of 8 characters, in upper/lower case, and special characters. Resetting passwords regularly is also recommended.

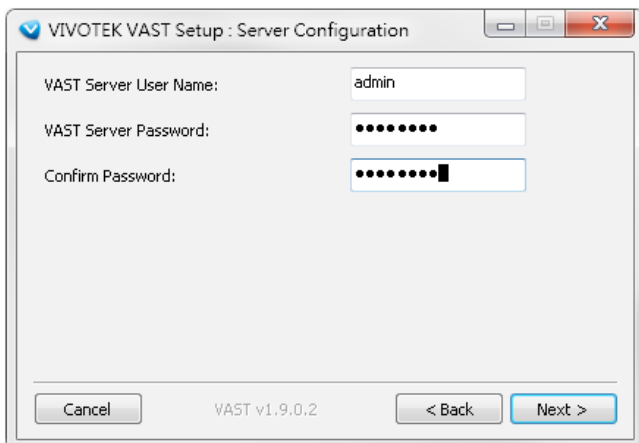

*Please record the user name and password for login later.*



*Once you have created a user account for a VAST station, you can login to VAST Server from any computer over the network through the LiveClient and Playback utilities.*

5. An SQL Lite database is automatically installed on your server. In order to avoid conflicts among different databases, we suggest you remove the original database from your computer.

Usually, you do not need to change the Station Listen Port and RTSP port for streaming video. If necessary, e.g., when the port has been occupied by other applications, change the port number.

Specify a file recording path on your server. Multiple recording groups can be created, and if you have more than 32 channels, it is recommended to assign a recording path on a different hard drive or RAID volume disk other than your system drive. Click **Install** to continue the process.

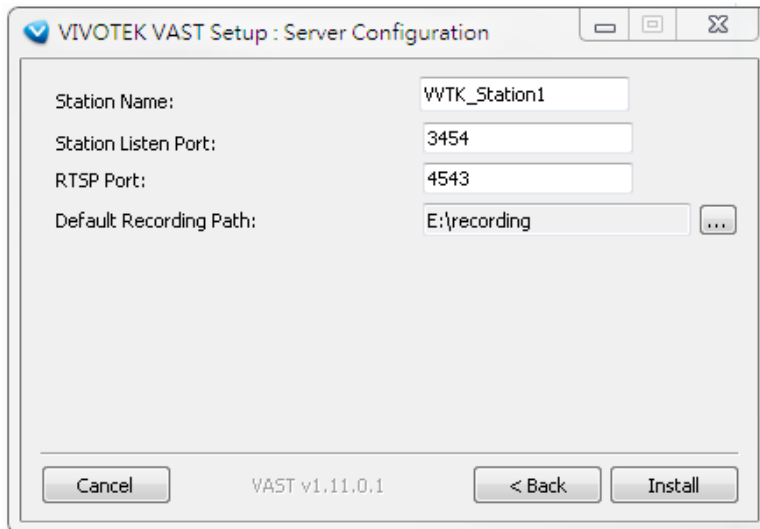

The installation process should be completed within several minutes. Shortcuts will be created on your desktop. Double-click on the shortcut to start using the software.

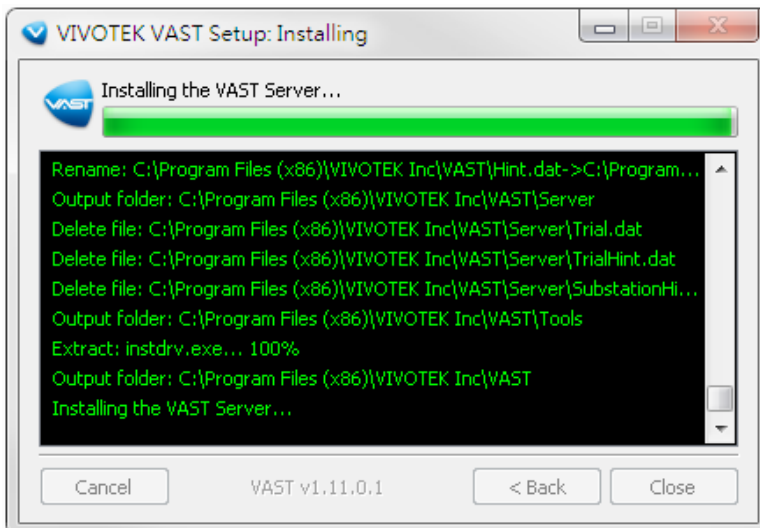

If you installed the trial version, you will be prompted to activate the trial license. Click **Yes** to start using the trial version.

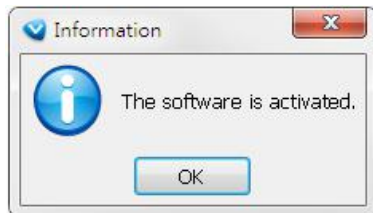
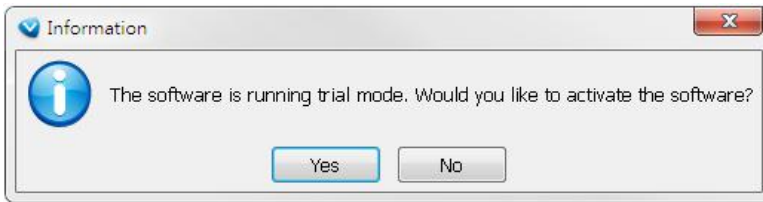

# VAST Server

## Activating the VAST Server

VAST Server is a service program that will run automatically when your VAST station starts. Users can also deselect the Auto launch option at windows startup on the VAST Service Control program tray. The program tray icon can be located on Windows tool bar.

## How to Configure the Server

Please follow the steps below to configure the VAST Server:

1. Find a local/remote computer that has installed VAST LiveClient.
2. Activate VAST LiveClient and login to the target VAST Server.
3. Configure the server using the VAST LiveClient user interface.

## How to Stop/Reboot the Server

Please follow the steps below to stop/reboot the server:

1. Click on the VAST Service Control program tray icon in the toolbar.



2. There are 3 options: Start Service, Stop Service, and Restart Service. It's selectable by a right-click on the Service Control program tray icon.

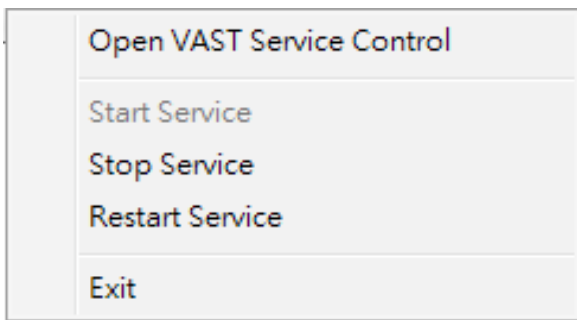

# VAST LiveClient Configuration

## Activating the VAST LiveClient and Logging in to a VAST Server

VAST LiveClient allows you to monitor live video from cameras managed by the VAST Server; it is also the main user interface for server function control.

After installing the VAST LiveClient program, please follow the steps below to activate VAST LiveClient:

1. Run the **VAST LiveClient** program.
2. A **Login** window will pop up. Enter the information as shown below:
  - If you want to login to a remote VAST Server, enter the **IP Address**, **User Name**, **Password** and the **Communication Port** of the target server correctly. Click **Login** to log in to the target server.
  - If you want to login to a local host that is running VAST Server, check the **Login local station** check-box, then the local **IP Address** will be displayed automatically. Enter the **User Name**, **Password**, and **Communication Port** of the local server for login. Click **Login** to login to the target server.

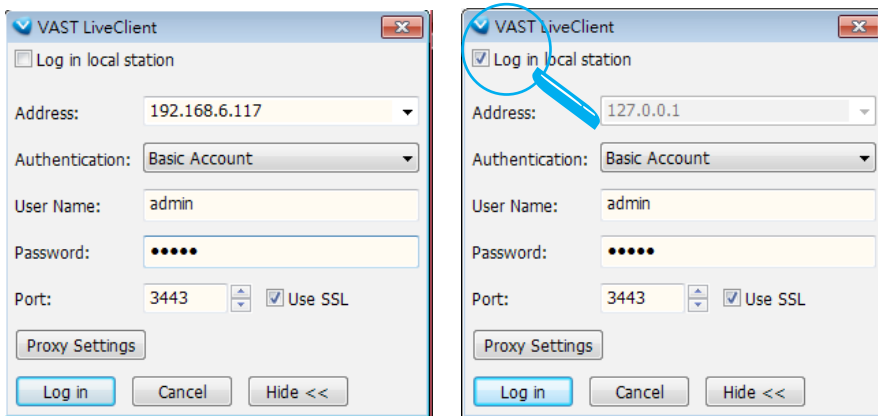

- Please refer to page 103 for how to enable and configure **Windows AD accounts**.

3. The VAST LiveClient monitoring window will prompt.



- If your network environment needs to set up proxy, click **More >>** to extend the login window, then click **Proxy Settings** to open the dialog. Then enter related information to link to your proxy server.

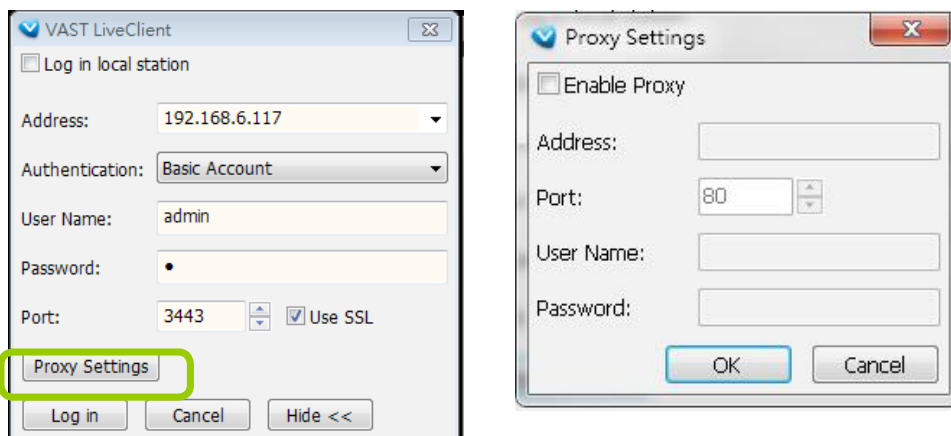

- Available functions of the VAST LiveClient program will be enabled according to the role of your login account. For more details about the privileges of the user account, please refer to **How to Manage User Accounts** on page 100.

If you use LiveClient to access a remote VAST server, you can use the SSL login for secure connection.

To prevent network layer attack, the management session between a VAST LiveClient and server can be encrypted using the HTTPS connection. HTTPS (Hypertext Transfer Protocol over Secure Socket Layer) encrypts the traffic between web browsers and servers.

When starting the LiveClient, click the More button, and select the **Use SSL** checkbox.

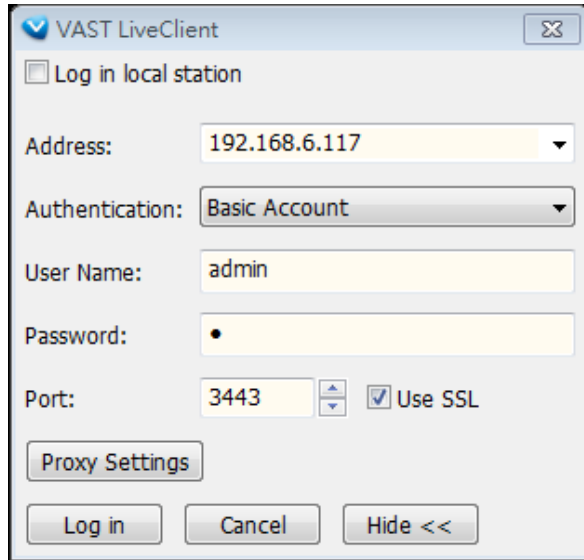
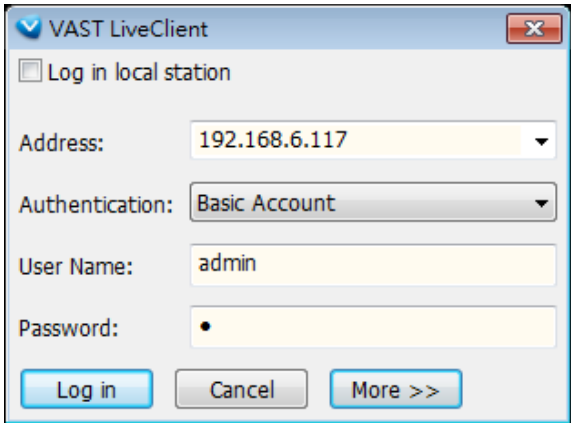

## VAST LiveClient User Interface

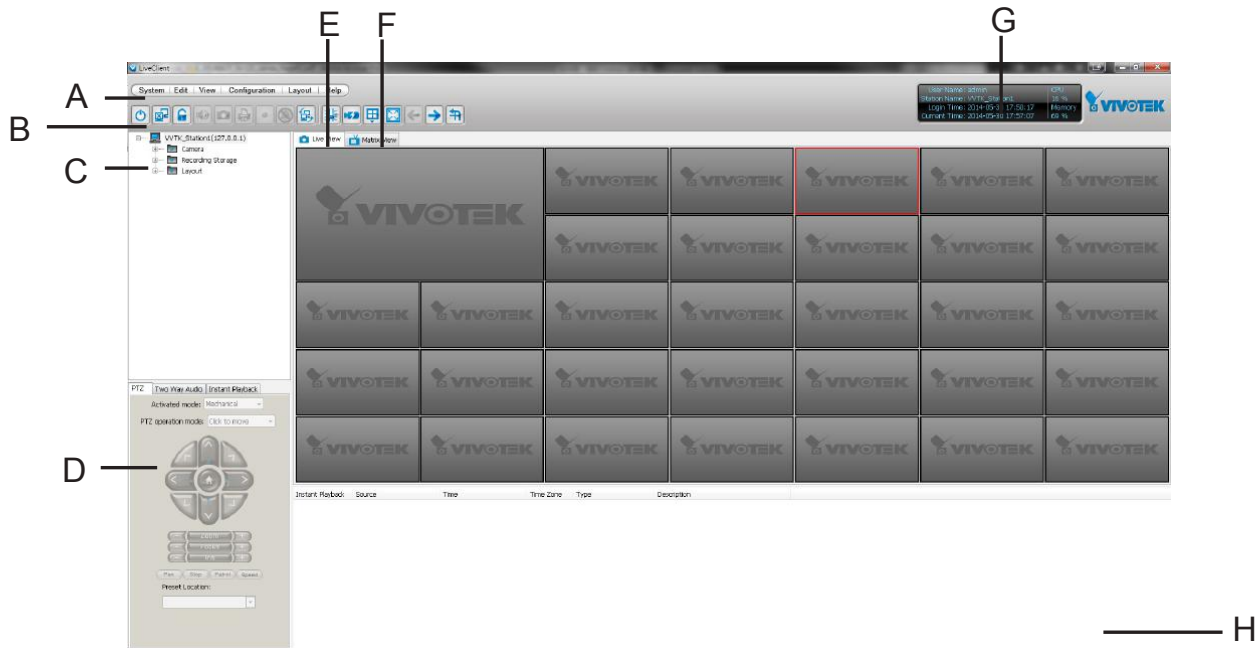

- A. Menu bar                      B. Quick access bar                      C. Hierarchical management tree  
 D. Camera control panel (PTZ / Two way audio / Instant Playback control panel)  
 E. Live view window    F. Matrix view window    G. Status panel    H. Alarm window

### Menu Bar



Menu Item	Drop-down Options
<b>System</b>	Lock / Enable Click On Image (Disable Click On Image) / Language / Second View / E-map / Launch Playback / Logout / Exit
<b>Edit</b>	Manually Begin Recording (Stop Manual Recording) / Snapshot / Print / Record to EXE (3GP, AVI) / Snapshot Zoomed Image / Print Zoomed Image / Find
<b>View</b>	Logical Tree view/ Device Tree view/ PTZ Panel / Two Way Audio Panel / Instant Playback Panel / Alarm Window / Full Screen / Minimize / Matrix View
<b>Configuration</b>	Camera Management (Insert Camera / Update Camera / Delete Cameras / Batch Insert Cameras / Camera Configuration) / Station Management / Logical Tree View management / IO Box Management / User Management / Association Management / Alarm Management / Virtual Matrix Management (Matrix Management / Matrix View Settings) / Station Settings (General Settings / Network Settings / Recording Storage Settings / Recording Schedule Settings / Scheduled Backup Settings / Server Settings / Relay Settings) / Client Settings (Snapshot Settings / Recording Settings / View Settings / General Settings / Joystick Settings / Proxy Settings / PiP Settings) / Video Enhancement (Basic Image Adjustment / Defog)
<b>Layout</b>	Start Rotating (Stop Rotating) / Save to / Delete / Choose
<b>Help</b>	About / License

## Status Panel

User Name: admin	CPU
Station Name: VVTK_Station1	35 %
Login Time: 2014-04-22 10:23:09	Memory
Current Time: 2014-04-22 11:14:54	61 %

User Name
Station Name (IP Address)
Login Time (yyyy-mm-dd hh:mm:ss)
Current Time (yyyy-mm-dd hh:mm:ss)



## Help Panel

The Help panel provides software revision information and the access to the associated iViewer software in either the iOS or Android version. You can also click on the License button to review the number of cameras and manageable substations.

If necessary, you may also use the Import License button to activate the functionality you separately purchased or generate a license request.

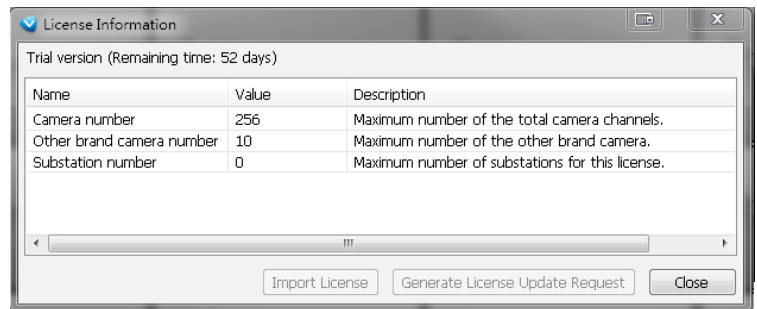

## Device Pack Update

A Device Pack consists of information of new VIVOTEK cameras or the updated information for previous models, such as various configurations including resolutions, FPS, DI/DO, etc. For example, some panels, such as the PTZ panel, may not be available for a new PTZ camera. Your VAST server might not recognize the features of the latest VIVOTEK cameras. With the Device Pack, you can configure and implement the latest VIVOTEK models without the need to upgrade the entire VAST software to acquire the associated information. Please visit: <http://www.vivotek.com/web/product/productdetail.aspx?Model=VAST>. For configurations not specified in the device pack, you can still open a web console with individual cameras to change their configuration.

You can consult VIVOTEK's technical support for the latest Device Pack [CSV files (\*.csv)], and use the Update... button in the Help window to replenish camera information. The update information will be displayed, and the update process is completed almost immediately.

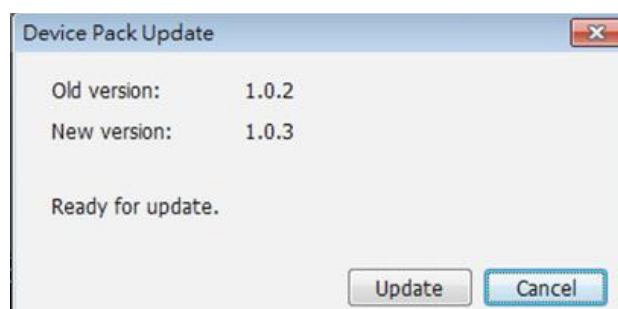

## Quick Access Bar

Icon	Function	Description
	Exit	Exit the system
	Logout	Log out from the current station
	Lock	Click to Lock the system for security concerns (  Unlock the system)
	Volume	Adjust the audio volume of the current video (  Mute)
	Snapshot	Capture pictures from the focus live video cell
	Print	Print out the pictures of focus live view window or all live video cells
	Record to Media	Record media in EXE/3GP/AVI format (  Recording Media)
	Alert Sound	Play sound when an event triggers
	Switch Screen	Switch the current window to another screen
	Adjust SVC Level	Dynamically adjust the SVC control over frame rates
	Remove All Connections	Remove all live videos from the live view window
	Layout	Change the layout of the live view window
	Full Screen	Maximize the live video cell
	Page Up	Switch to the previous live view page
	Page Down	Switch to the next live view page
	Start / Stop Rotating	Start or stop live view layout rotating



Some buttons will be disabled if the selected devices do not support the corresponding functions.

## Live Video Monitoring Window

The "VIVOTEK" logo is displayed where no camera has been assigned to a video cell.

The red frame ( ) represents the current selection.

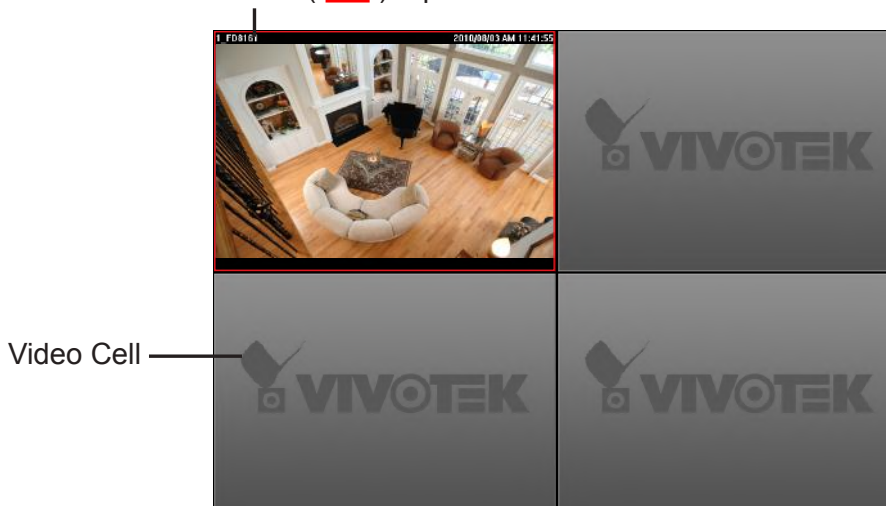

## Hierarchical Management Tree

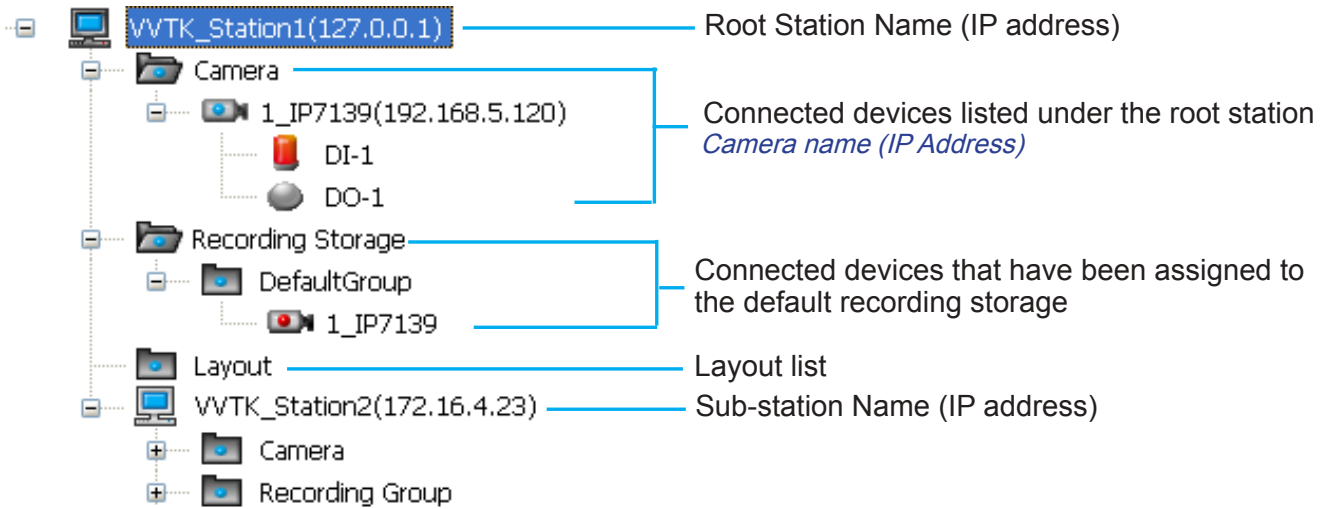



By default, the I/O device connection status display is disabled. You can turn up the display by visiting **Configuration > Client settings > General settings > Keep detecting camera DI/DO status**.

Icon	Description
	A station (The host that's installed with VAST Server)
	A station (The host that's installed with ST7501 Server)
	VIVOTEK fixed network camera (or ONVIF cameras) Red dot signifies that the camera is recording.
	VIVOTEK PTZ network camera Red dot signifies that the camera is recording.
	VIVOTEK dome network camera Red dot signifies that the camera is recording.
	VIVOTEK fisheye network camera Red dot indicates that the camera is recording.
	VIVOTEK video server Red dot signifies that the video server is recording.
	Digital input on / off
	Digital output on / off
	A layout of the live monitoring window
	A station that's not able to be connected currently.
	A device that's not able to be connected currently.

## Camera Control Panel

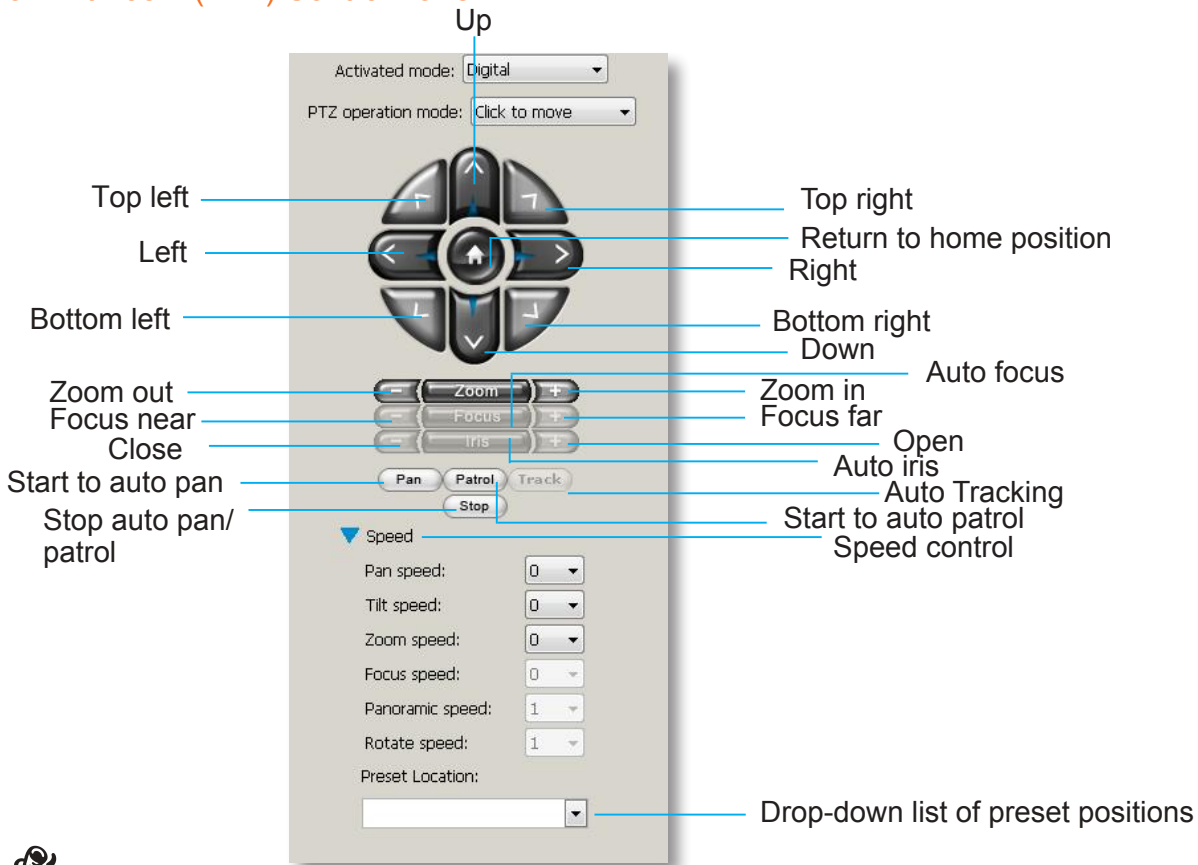
### Pan/Tilt/Zoom (PTZ) Control Panel



- There are two types of PTZ control: Digital (E-PTZ for megapixel cameras) and Mechanical (PTZ cameras or fixed cameras with camera control via RS-485). If the connected cameras support PTZ/E-PTZ function, the PTZ option(s) will appear on the drop-down list. For detailed camera control settings, please refer to the user's manual that came with VIVOTEK network camera.
- Click **System > Enable Click On Image** to use the mouse for the control of the PTZ and E-PTZ functions in the video cells for linked cameras. An icon  will appear in the video cell as shown below.

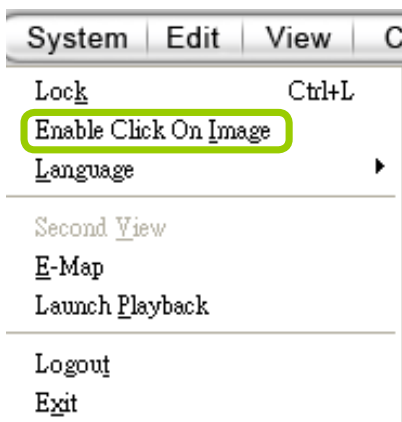

- You can control the PTZ function through joystick as well. For more information regarding to the joystick configuration, please refer to instructions on page 195.

VIVOTEK's latest SD8xxx speed dome series supports the **Continuous Move** control. The **"Click to move"** enables one movement by every mouse click on the PTZ buttons.

When Continuous Move is enabled from the PTZ panel, you can click and hold down the mouse button on an arrow key to command the camera to continue moving to that direction. The move will stop when you release the mouse button. Also, if the pan/tilt/zoom/focus speed is configurable for a PTZ camera, you can use the **Speed** button to display the speed options: pan, tilt, zoom, focus, panoramic, and rotate speeds.

For fisheye cameras, two more options will be available: Panoramic speed and Rotate speed. These two options apply to the onscreen control for the Panoramic and Regional views.



In addition to the PTZ panel, the following hot key combinations are also available:

Ctrl + NumPad (PTZ control)		
Up	Ctrl + 8	
Left	Ctrl + 4	
Home	Ctrl + 5	
Right	Ctrl + 6	
Down	Ctrl + 2	
Focus (Far - Near)	Ctrl + 1	Ctrl + 3
Zoom (Out - In)	Ctrl + 7	Ctrl + 9
Pan	Ctrl + /	
Stop	Ctrl + *	
Patrol	Ctrl + -	

Preset locations (pre-configured by users)	Ctrl + 0~9 (number keys above the alphabetic keys)
Full screen	Ctrl + F
Single view	Ctrl + V
Previous layout page	Alt + PageUP
Next layout page	Alt + PageDown
First layout page	Alt + Home
Last layout page	Alt + End
Snapshot	Ctrl + S
Stop alarm	Ctrl + A
Mute audio from current stream	Ctrl + M
Start/ Stop rotation	Ctrl + O

## Two Way Audio Control Panel

The two way audio function allows the user to remotely communicate with people nearby the network camera.

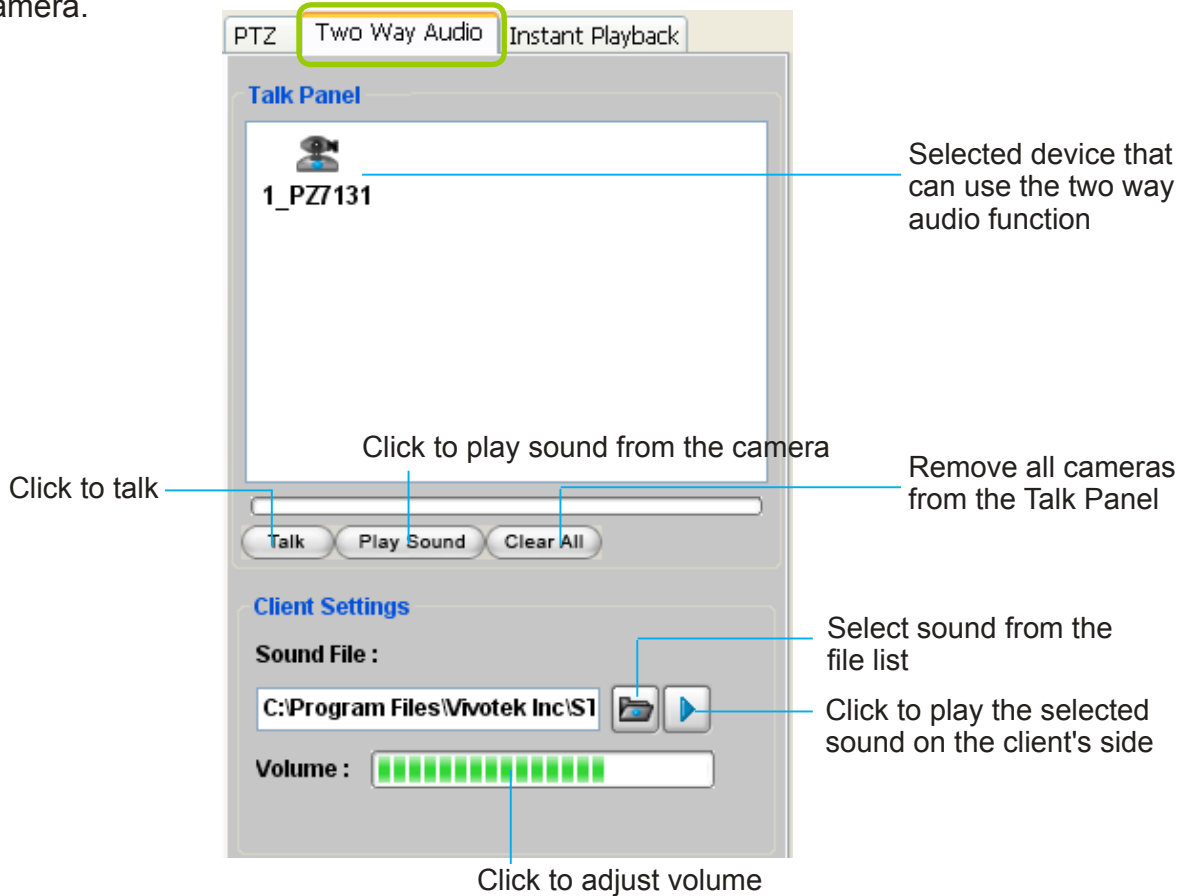

- For detailed information about **How to Use the Talk Panel**, please refer to page 166.
- Only cameras that come with the two way audio function can be added to the Talk Panel.

## Language Selection

VAST currently supports multi-lingual user interfaces including: English, Český, Deutsch, Español, Farsi, Français, Italiano, 日本語, Português, Русский, 简体中文, 繁體中文. If you want to select another language for the interface, please click **System > Language** on the menu bar to select the desired language. Please note that if you want to change the language option, a message will prompt to remind you to restart the system.

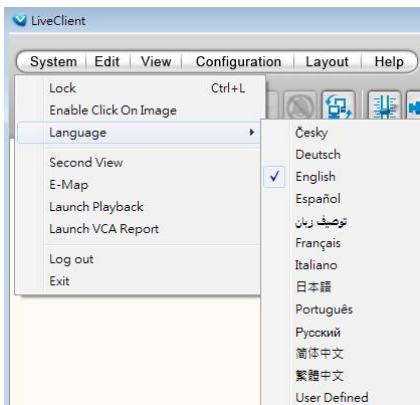

If you want to use "User Defined" language, please prepare images and language strings, and upload the files to the following folders:

...\\VAST\Client\LiveClient\language\lzz\_UD (language string)  
 ...\\VAST\Client\LiveClient\image (images)

## Alarm Window



- Only the alarm-related messages will be displayed in this window. An Alarm is a configuration consisting of triggers and reactions set to activate during a specific period of time. The Alarm-related settings is configured in **Configuration > Alarm management**. See page 111 for more information.
- For the event messages of the overall system operation, please refer to the **Playback > Log viewer**.
- If a VAST server is reset, the Alarms will disappear from the Alarm window. You can go to the Playback utility and use the **Alarm search** function to retrieve the past events.

Click **View > Alarm Window** to open a window showing the real-time information for event triggers. If you want to hide this window, deselect this option on the menu bar.

Instant Playback	Name	Description	Source	Event Type	Value	Time	State
	IP3159HP mo...	motion detection	Mega-Pixel Network Camera	Motion - Window 2	25%	2014-09-25 13:49:37.384	New
	IP3159HP mo...	motion detection	Mega-Pixel Network Camera	Motion - Window 1	51%	2014-09-25 13:49:27.753	New
	IP3159HP mo...	motion detection	Mega-Pixel Network Camera	Motion - Window 2	78%	2014-09-25 13:49:20.400	New
	ADAM6052	site1	ADAM-6052 DI-3	DI	Trigger	2014-09-25 13:41:32.178	New
	ADAM6052	site1	ADAM-6052 DI-1	DI	Trigger	2014-09-25 13:20:36.118	New

Event Window

The default Alarm window is set to be fixed on the bottom of the LiveClient. If you want to change the Alarm window as a popup page, please open the **Configuration > Client Settings > General Settings** window to switch the display modes.

- Camera Management
- Station Management...
- Logical Tree View Management...
- I/O Box Management
- User Management...
- Association Management...
- Alarm Management...
- Virtual Matrix Management
- Failover Management
- Search VivoCam Switches...
- Station Settings
- Client Settings**
- Video Enhancement

- Snapshot Settings
- Recording Settings
- View Settings
- General Settings**
- Joystick Settings
- Proxy Settings
- PIP Settings

**General Settings**

**System Settings**

- Automatically log in after logging in to operating system
- Automatically display in full screen after login
- Auto add newly-inserted camera to video cell
- Retrieve RTSP stream on specified port: 4543
- Connect substation streaming via relay
- Keep detecting DI/DO status
- Sort camera by name

**Alarm Settings**

- Enable live alarm notification
- Enable alert sound(s)
- Enable E-Map popup window
- Alarm window mode:  Fixed  Popup

**Rotation Settings**

- Enable rotation after login
- Rotate the page every 10 second(s) (3 ~ 999)

**Display Settings**

- Maximum number of view cells 64
- Enable auto stream size: Quality first
- Enable de-interlace function
- Enable Instant Replay on video cell
- Default replay length: 30 seconds
- Local streaming buffer time: 0 millisecond(s) (0 ~ 10000)

- The **Event Type** field in the Alarm window shows the event category and another field **Value** displays the **percentage** of motion in the detection window. You can go to the Configuration setting page of the connected device to set the percentage.



## Alarm Filter

On the Alarm panel, a list of alarms will be displayed. Click on the attributes with a funnel icon.

Instant Playback	Name	Description	Source	Event Type	Value	Time	State
	SD DI		SD8161 DI-2	DI	Trigger	2015-07-31 11:50:36.426	New
	SD DI		SD8161 DI-2	DI	Trigger	2015-07-31 11:50:24.722	New
	SD DI		SD8161 DI-2	DI	Trigger	2015-07-31 11:50:13.750	New

The Alarm Filter window will prompt. Use the Name, Time selector, and the State checkboxes in the Source and Event Type panes to specify what kinds of alarms will be displayed.

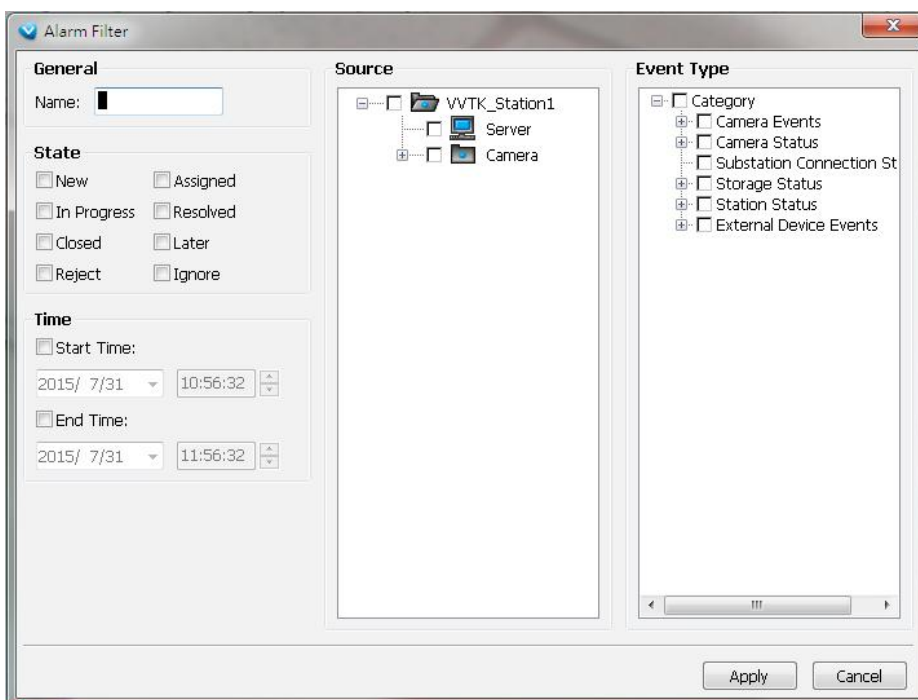



For example, you can set up a filter to display the alarms with a name associated with a specific camera, such as "bullet on the corridor." The name of the alarm is configured in **Configuration > Alarm** management on page 111.

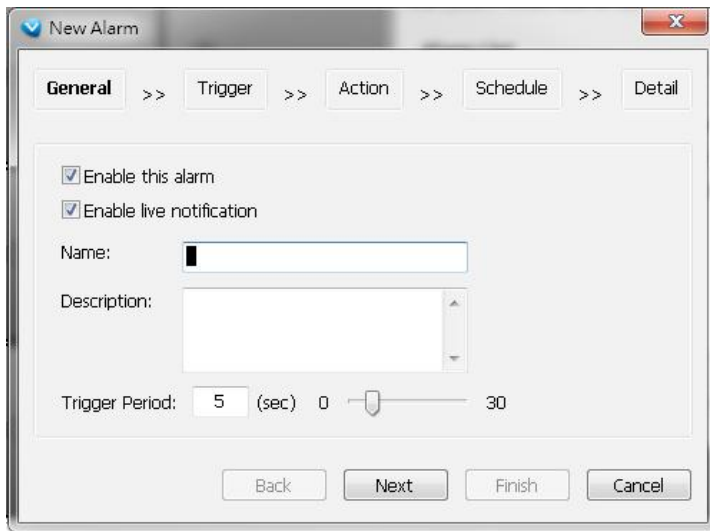

Use the Filter tab at the bottom of the Alarm window to display a different sorted result.

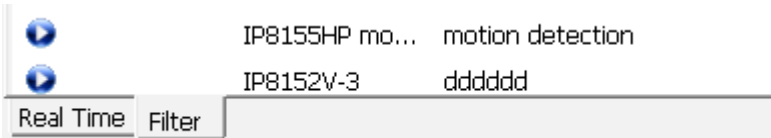

### Alarm State

Left-click to select an alarm, and then right-click to display the **Update Alarm** button.

Source	Event Type	Value	Time	State
SD8161 DI-2	DI	Trigger	2015-07-31 11:50:36.426	New
SD8161 DI-2	DI	Trigger	2015-07-31 11:50:24.722	New
SD8161 DI-2	DI	Trigger	2015-07-31 11:50:13.750	New

You can change the alarm state from the pull-down menu. For example, if someone has already been sent to check out the situation, for example, an intruder broke in through a window, you can select the Assigned status. A 1024 bytes description can be added into the alarm Note for

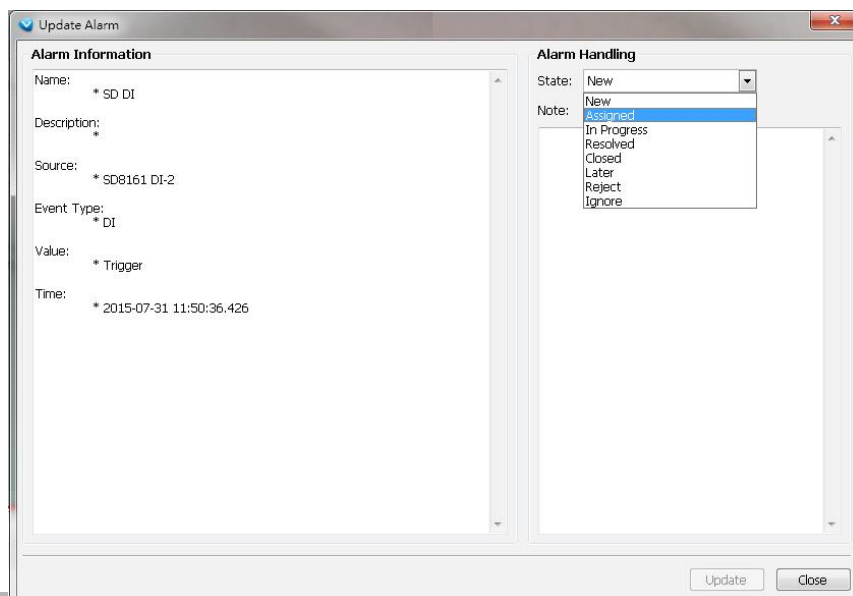

future reference.

If an alarm is proved as a false alarm, the alarm can be designated as Ignore or Resolved, and so on.

The different alarm states can also be used as the filtering conditions in the Alarm filter. Single or multiple states can be selected in the filter. For example, to display the Resolved alarms only, use the Resolved state as the filter.

## Instant Playback

Check **View > Instant Playback** to open the window on the panel. The entries listed in the Event panel are the short recordings made from triggered events.

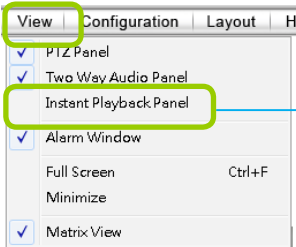

Deselect this item if you want to hide this window.

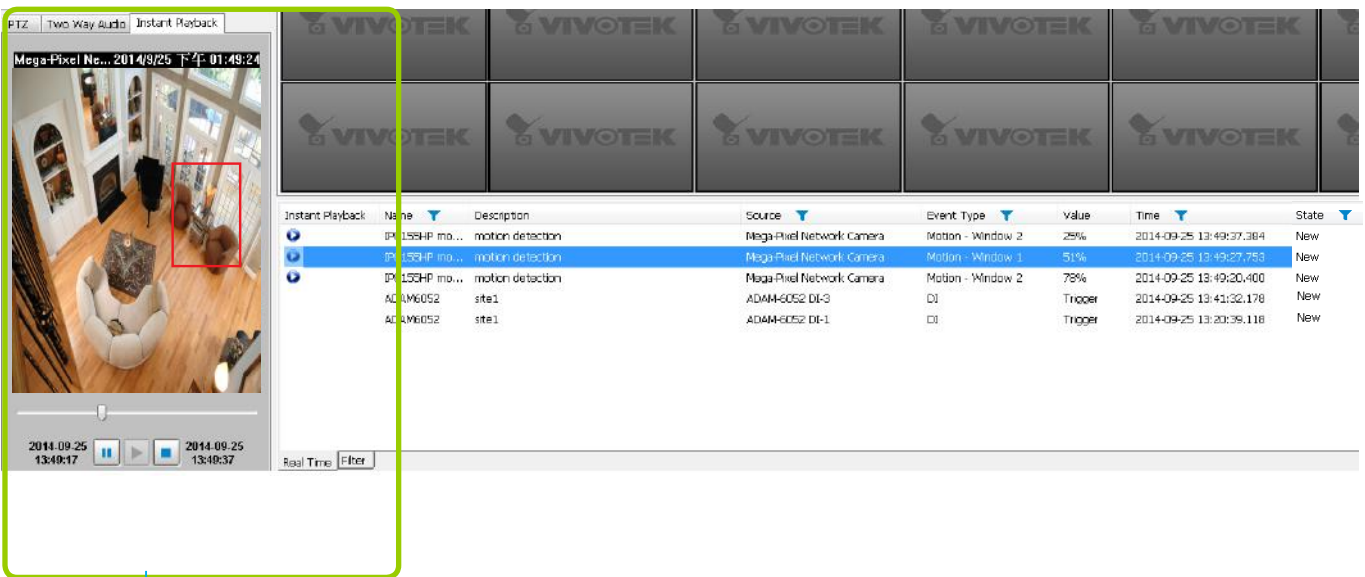

Instant Playback Window with a slide bar, play, pause, and stop function

The recorded media that was triggered by an event will be indicated with a playable  icon.

You can **double-click** an event on the list to playback the recorded video. Each event contains a video clip of 20 seconds in length. (The default recording data of an event is 20 seconds. For more information about event recording, please refer to page 137.)

## Instant Replay



If a camera is currently recording to the VAST server, then a Replay button will be available at the lower left corner of its view cell. This allows you to immediately retrieve the video recording in the past few seconds or minutes.

The Instant Replay function enables you to quickly retrieve videos of what has just happened (20 seconds to 15 minutes ago), without the need to open the Playback utility for the past videos.

### Prerequisites for Instant Replay:

1. The function is enabled by default, only available on a LiveClient installed on a PC.
2. There must be recorded videos of the immediate past. If the video streams from a camera were not recorded, you can not retrieve videos using the Instant Replay function.



### NOTE:

1. When using the Instant Replay function and you change the stream number on a video cell, the Instant Replay will be interrupted.
2. The Instant Replay will also be interrupted when the time comes for a rotation of Live View pages. For example, if you have multiple Live View pages and you set up a rotation of these pages by every 10 seconds, page swap (rotation) still has a higher priority even if you are viewing the Instant Replay.

### How to Use:

1. On a selected view cell, mouse over to the lower left corner. A Replay icon  will appear.
2. Click on it to display the Replay control bar. Click on the play button.



3. The default queue length is 30 seconds. You can click on the number on the right to change the queue length.

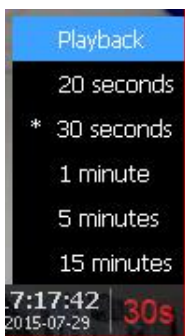

The Playback option allows you to directly open the Playback utility. A maximized single view window will open. In this single view, previous recording will be played, but, unlike the smaller Instant playback pane, the playback will continue until manually stopped.

This playback mode is not memorized as the norm the next time you use the Instant Replay function.

The queue length configuration stays with the view cell, and it will not go unless you remove and insert the camera again.

4. To stop the Replay and return to the Live View, click on the **Return to Live** button. 
5. On a Replay view cell, you can apply the same Snapshot, Print, Single view and Full screen control as those on a normal view cell. You can also right-click to display the Display Mode and Video Enhancement functions.

Click and drag the playhead to skip or move to a different point in time on the playback.

An active Replay view cell is indicated by the Replay text indicator and the time of occurrence of the current playback.



To change the default Replay settings, open the Configuration > Client Settings > General Settings menu.

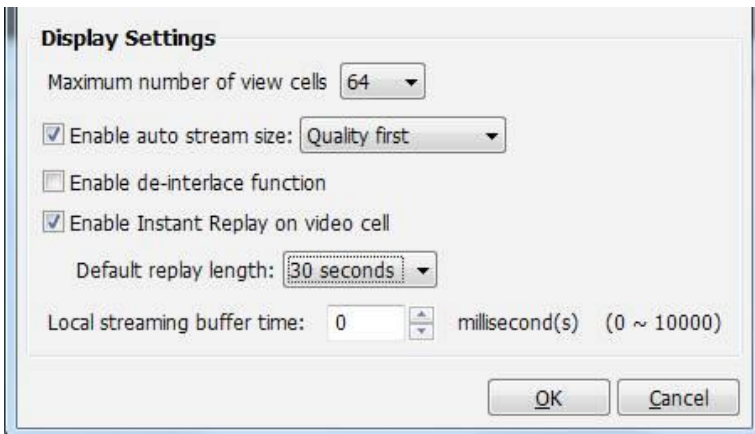

## Audio Control



The audio function will be enabled if the device is equipped with an internal or external microphone. For detailed audio control settings, please refer to page 138.

## How to Manage Devices

Please follow the steps below to open the Camera Management window:

- Select the station from the hierarchical management tree.
- Click **Configuration > Camera Management** on the menu bar (or **right-click** the station, then select **Camera Management**).
- Then you can choose to insert, update, delete, or batch insert cameras.

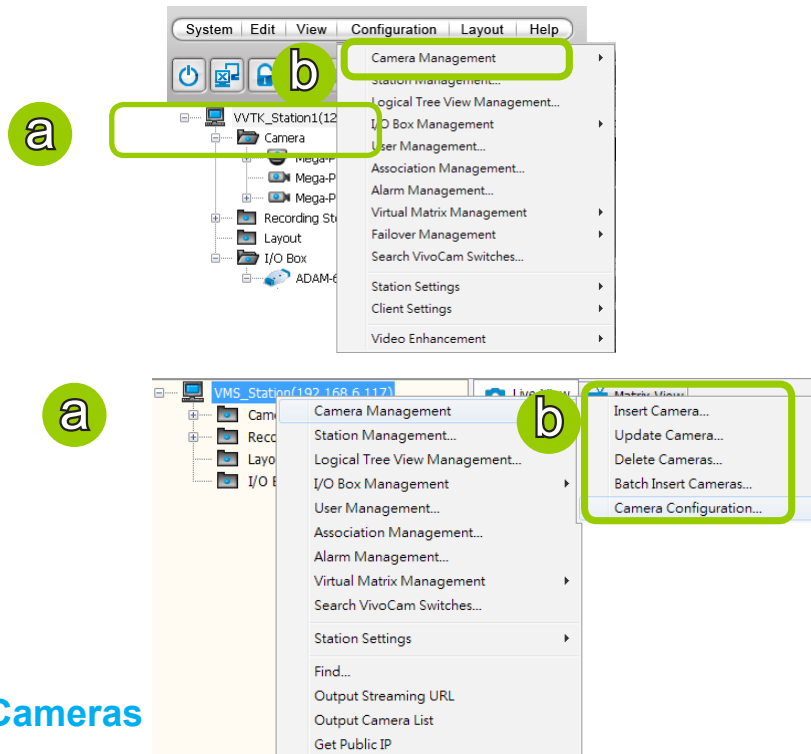

### Insert Cameras

Please follow the steps below to add devices to a station:

- Click **Configuration > Camera Management > Insert Camera** on the menu bar (or **right-click** the device/station, then select **Camera Management > Insert Camera**).
- The **Camera Management - Insert** window will pop up. The device tree managed by the station will be displayed in the left Camera List window.
- Enter the **Camera Name**, **IP address** (or you can enter an **IP address** and check **Auto** to get a camera name automatically) and configure the **Connection Settings**.
  - If the camera is on the LAN, you can click  **Search Camera** to detect all VIVOTEK network cameras on the LAN. A **Camera List** window will pop up and show a list of detected cameras on the LAN. On the top of **Camera List** window, you can select "**List the cameras which are not inserted**" or "**List all cameras**". The items listed below will then change accordingly. You can click **Mac**, **IP Address**, **Model**, **HTTP port** to sort the items. Then select a camera from the list to insert to the station.
  - The streaming protocol determines how the live video stream is sent from the camera to the local computer. Please refer to the note on the next page for a detailed description of each transmission protocol. Specify the recommended live monitoring stream for the device. If you want to change the live viewing stream, please refer to the next page to update the camera settings. Or you can **right-click** the desired cell, then select a desired stream. Please refer to Dual / Multiple Streams on page 73 for a detailed illustration.
  - Click **Detect Model** to detect the device. The Model Name and MAC Address of the device will automatically be displayed in the respective fields if the connection is successful.
- If you want to make sure you are connected to the target device, click **Connection Test** to preview the live video from the device.

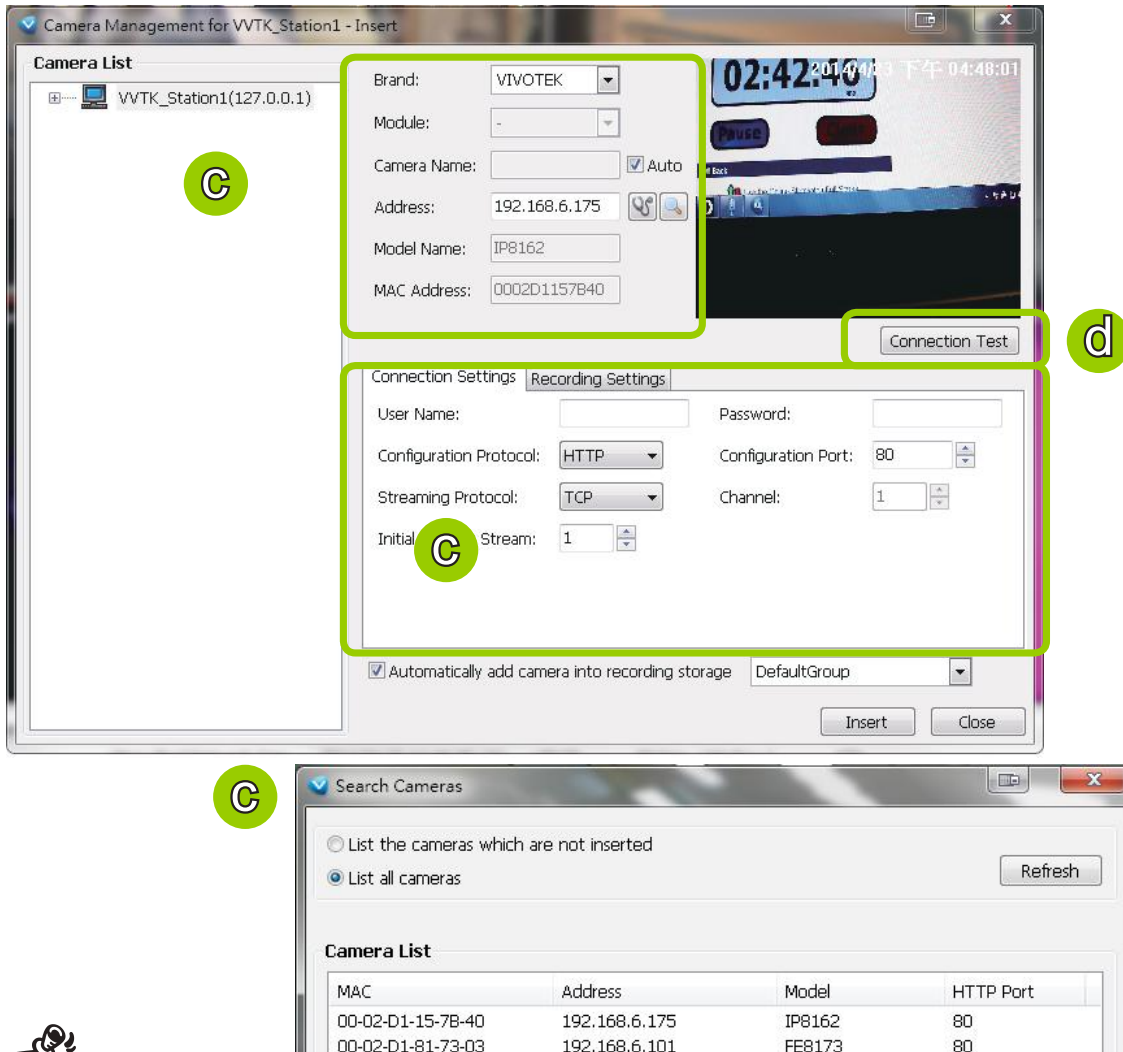

- If you want to use "HTTPS Port", please enable the HTTPs settings on the configuration page of the Network Camera first.
- The characteristics of each protocol are shown in the following table:

Protocol	Description
UDP	UDP uses a simple transmission model without implicit hand-shaking dialogues for guaranteeing reliability, ordering, or data integrity. Thus, UDP provides an unreliable service and data grams may arrive out of order, appear duplicated, or go missing without notice. This protocol allows for almost real-time audio and video streams. However, network packets may be lost due to network burst traffic and images may be obscured. Activate UDP connection when occasions require time-sensitive responses and video quality is less important.
TCP	TCP provides the service of exchanging data reliably directly between two network hosts, whereas IP handles addressing and routing message across one or more networks. In particular, TCP provides reliable, ordered delivery of a stream of bytes from a program on one computer to another program on another computer. This protocol guarantees the delivery of streaming data and thus provides better video quality. The downside with this protocol is that the real-time effect is worse than that with UDP for a narrower bandwidth.
HTTP	HTTP is a networking protocol for distributed, collaborative, hypermedia information systems. It's the foundation of data communication for the World Wide Web. This protocol allows for the same quality as TCP and the users need not open a specific port for streaming under some network environment. Users inside a firewall can utilize this protocol to allow streaming data through.
HTTPS	This protocol enables authentication and encrypted communication over SSL (Secure Socket Layer), which protects streaming data transmission over the Internet on higher security level.

e. Configure **Recording Settings**:

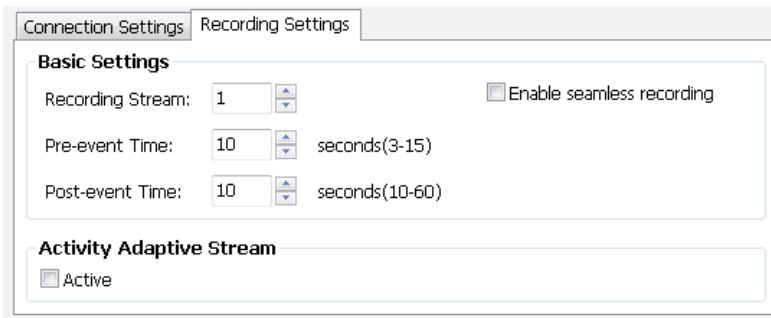

- Recording Stream: By default, the stream source of the recording stream is stream 1, if you want to change it later on, please refer to the previous page to update the camera settings (Update Camera).
- Pre-event time: Enter a number to decide how much time to record before an event is triggered.
- Post-event time: Enter a number to decide the duration of recording after an event is triggered.

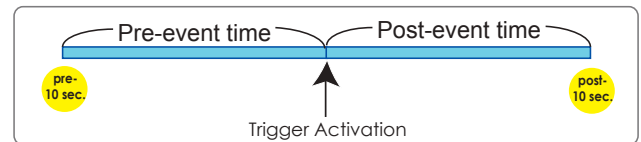
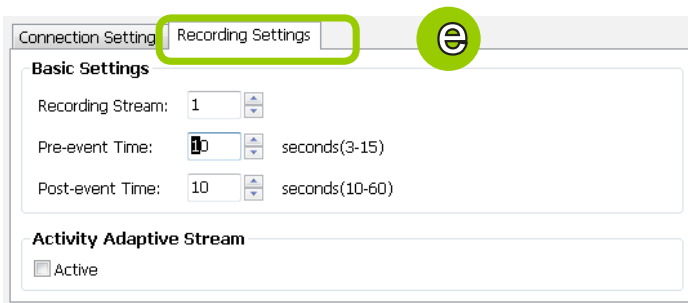

For example: If both the Pre-event time and Post-event time are set to 10 seconds, a total of 20 seconds of video will be recorded if an event is triggered. This function is supported by the buffer area on a VAST server.

Note the following with the associated configuration:

- The Pre-/Post-event time configuration only applies to event recording.
- The Activity Adaptive Stream (a.k.a., AAS) only applies to the Continuous Recording.
- Activity Adaptive Stream (active if possible): Check this item to enable activity adaptive stream recording. For cameras that come with multiple streams features, users can make use of activity adaptive streaming for dynamic frame control.

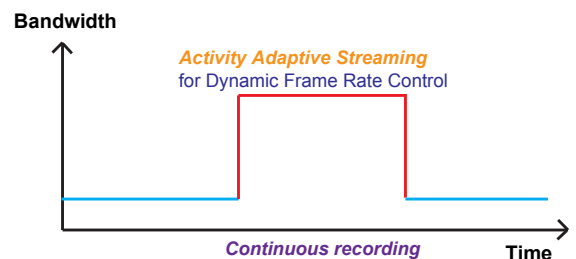
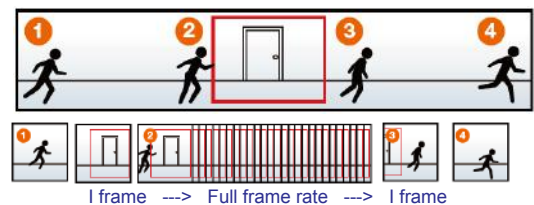

If you check Activate Activity Adaptive Stream, the VAST server will record full-frame-rate video only when an event is triggered on the camera; otherwise, it will only request the I frame data during normal monitoring, thus effectively save lots of bandwidths and storage.

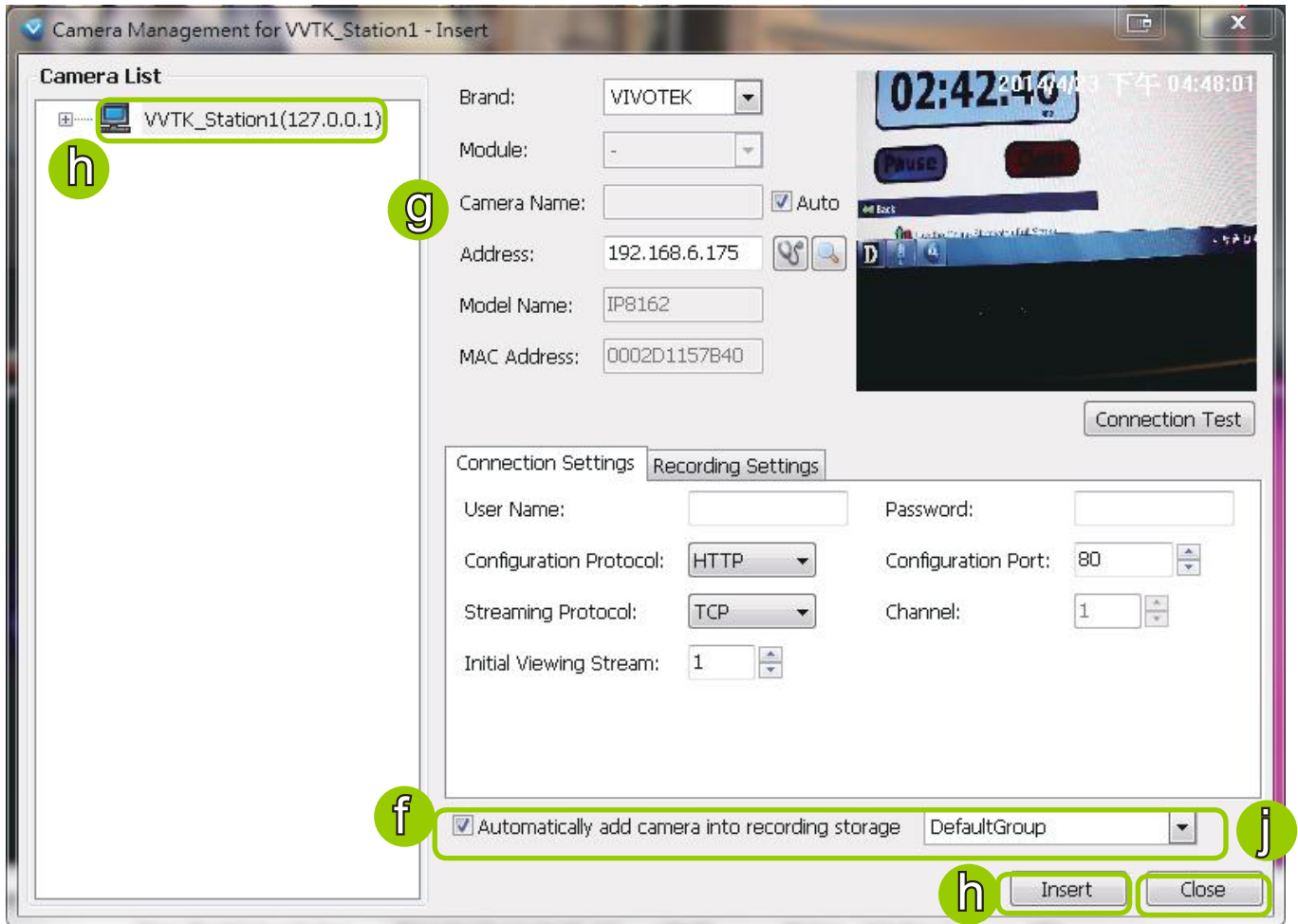

- f. The device will automatically be assigned to the default recording group. Deselect the item if you want to cancel this setting.
- g. You can deselect the "Auto" checkbox behind the **Camera Name** entry, and manually enter a name of your choice, such as "East alley bullet." This name will be used as the folder name for the recorded video files. An index number will still be appended to the folder name. Note that if this name is changed when the recording is taking place, the configuration change will not take effect until the next day.
- h. When all settings are completed, click **Insert** to add the device to the station. The device will be displayed under the Camera List on the left.
- i. To insert additional devices to the station, repeat the above steps.
- j. When completed, click **Close** to exit the camera management window.
- k. Back to the main window, you will find the newly-inserted devices displayed under the station and the live video in the video cell.

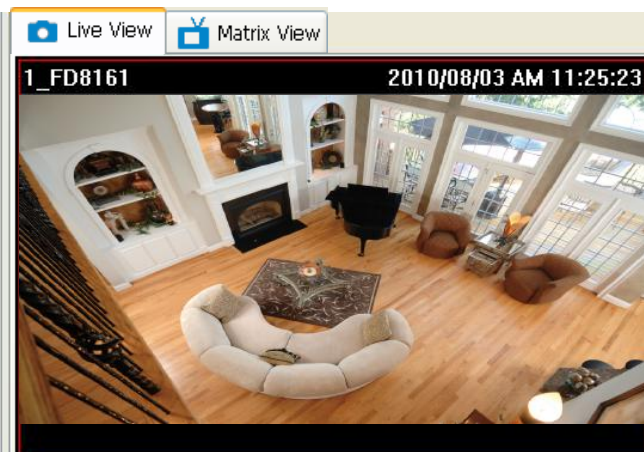



## Seamless Recording

Seamless Recording safeguards critical videos in the occurrences of network disconnection. In the event of temporary disconnection, video is stored in individual cameras' SD/SDHC/SDXC card; and once the connection is restored, a VAST server can automatically resumes the recording. More remarkable is that, a VAST server can simultaneously retrieve the time-tagged videos that were temporarily stored on SD/SDHC/SDXC cards. For information about the latest firmware/software revisions that support this feature, please contact your sales representatives or technical support.

### Seamless Recording

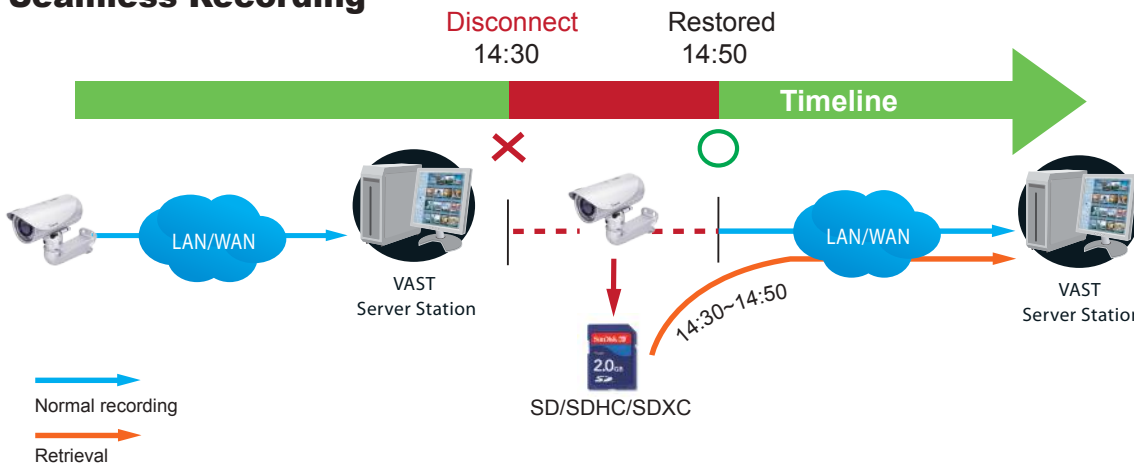

The video data retrieved from SD/SDHC/SDXC card also include event-triggered recordings such as pre- or post-event footages, if events were detected during the network outage.

The Seamless Recording feature is enabled when inserting, updating, or batch inserting cameras in the Camera Management window. The firmware/hardware compatibility of this feature is automatically detected, i.e., this feature is not available when a non-compliant camera is attached. If a compatible camera is attached, a checkbox will be available as shown below.

Enable seamless recording

**Tips:**

Try out the Detect model button on the Insert Camera page if the Seamless Recording checkbox does not appear.

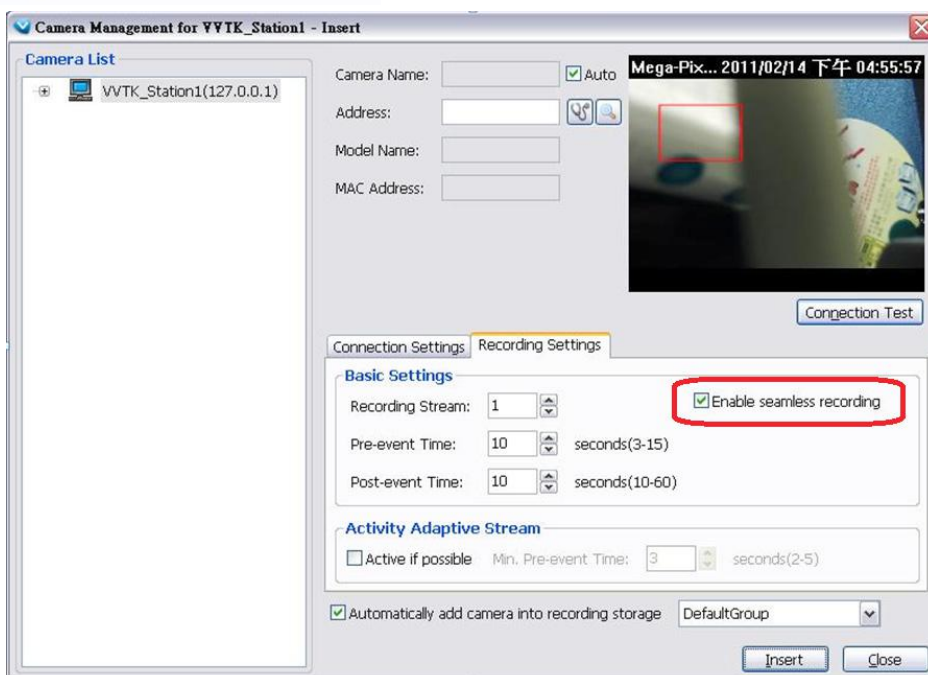

Brand: VIVOTEK  
 Camera Name:   Auto  
 Address: 192.168.6.207  
 Model Name: MS8391-EV  
 MAC Address: 00028391C319







- When the SD/SDHC/SDXC card storage space is full, cameras will stop recording. When the network connection between VAST server and cameras is restored, videos in the SD card will be transmitted back to the VAST server. Note that the videos that were not recorded during the time when the network was disconnected will not be transmitted.
- If the videos on the cameras belong to those that are about to be erased within 24 hours (e.g., for the lack of storage space on a VAST server), those videos will not be retrieved.

**Limitations:**

- Retrieving video fragments from a camera can momentarily double the throughput of normal video streaming.
- Video streams recorded using the MJPEG codec is not supported by Seamless recording.
- Seamless recording can only take place from a camera with 1 video stream recorded to a maximum of 3 VAST servers. .

**Onscreen Elements for Seamless Recording:**

- The associated icons will appear in the Liveview, popup window on e-Map, and the Matrix view. The status icon appears on the upper right of the view cell.
- Below is the description of the Seamless recording statuses and the indicative icons. Normally the video fragments will be retrieved first, and then the event log:

	Currently not recording video from camera, but is retrieving data from camera due to previous disconnection.
	Currently not recording video from camera, but is retrieving event log.
	Currently recording video to system as well as retrieving data.
	Currently recording video to system as well as retrieving event log.

After a period of time, the gaps of recording (those blue lines or blocks representing network interruptions during the recording) should be gradually stitched up. It is, however, system integrators' responsibility to build a reliable network. Additional bandwidth should also be available for retrieving fragmented recordings from the camera side.

The VAST checks for the need for retrieving fragmented videos by every one minute. If the retrieval failed due to some network faults, the server will re-try the retrieval tasks later on.

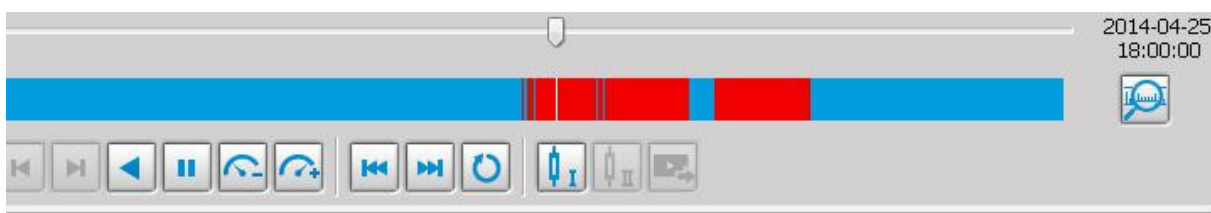

In the Playback utility, you can select the tabbed window on top of the device tree to select **"Seamless Recording Status."** If, after a cable disconnection, you can select to check if the Seamless recording has duly performed a recovery.

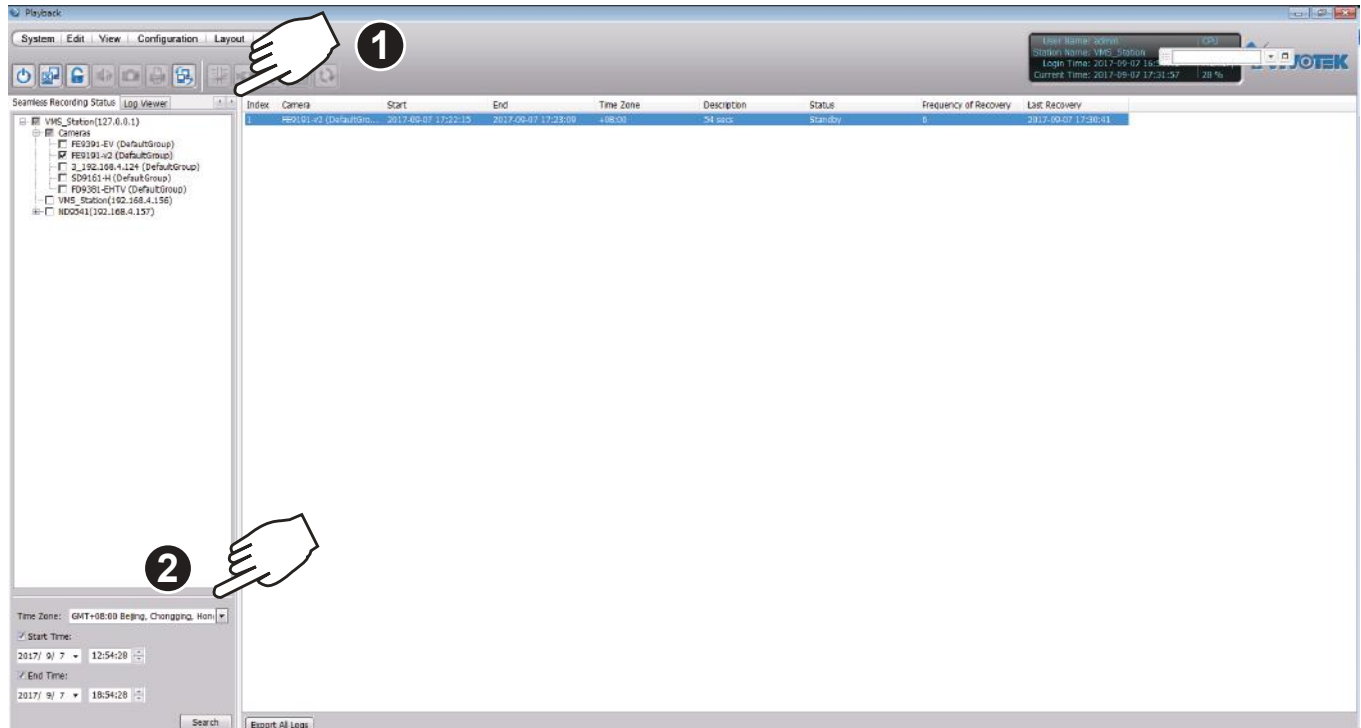

Note that when a cable is disconnected, the Seamless Recording Status may not immediately display a disconnection event. The timeout for a disconnection is 1 minute, and the VAST server and camera will take some time handling the disconnection and re-connection. Even you notice the disconnection on live view, the Seamless Recording Status may take longer than 1 minute to display the current status.

Status	Description
Camera is Disconnected	The connection between server and camera has not been restored.
Standby	Standing by for recovery.
Recovering	Recovering recording data from camera.
Recover failed	Recovery errors occurred, and recovery failed.
Recover successfully	Recovery success.
No Need to Recover	No Need to Recover.

UI Elements	Description
Item	Description
Start time	Beginning of a disconnection.
End time	The end of a disconnection.
Time Zone	Time zone of the disconnection event.
Description	Length of the disconnection.
Status	The handling status for the disconnection event.
Frequency of Recovery	The attempts made to recover data.
Last Recovery	The time the last attempt was made to recover.

## Enable SVC

If the camera to-be-added supports the latest SVC (Scalable Video Coding) feature, select the SVC checkbox to enable the related control. The SVC feature enables streaming of videos for multiple clients from one single set of layered IP packets. Designed for saving bandwidth and CPU load on client stations, the frame rate of a video stream appearing through a view cell can be individually adjusted. This feature applies when an administrator experiences unstable video streaming due to the lack of network bandwidth, less-than-ideal hardware, or during an occurrence of network problems.

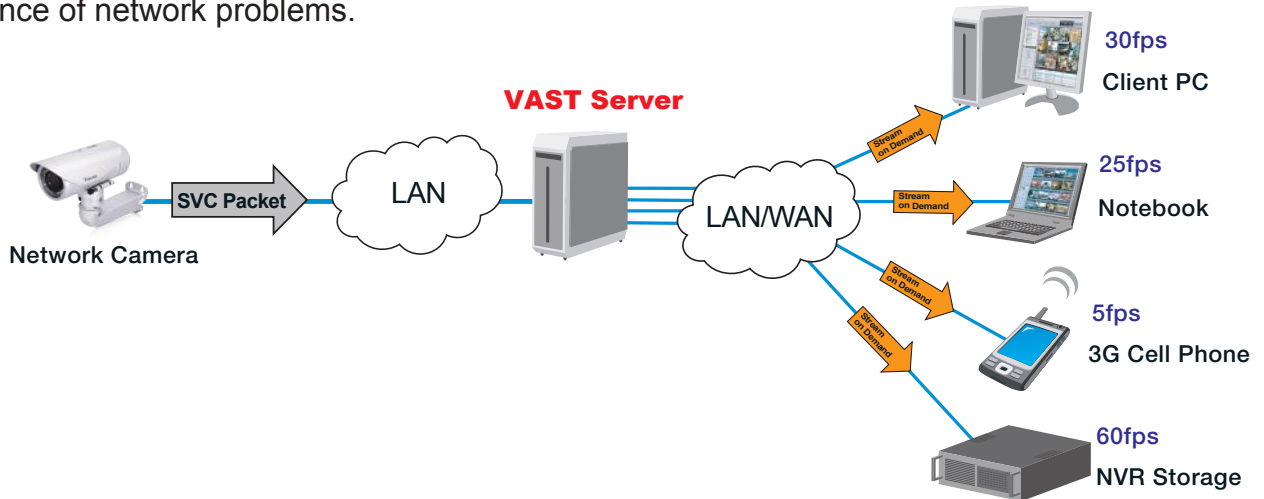

The VAST server (rev. 1.6.1 and later) automatically negotiates with a camera and determines whether a network camera comes with the SVC feature.

To configure the SVC-related feature:

1. When inserting a new camera into your configuration, select the streaming option, usually the stream #1.

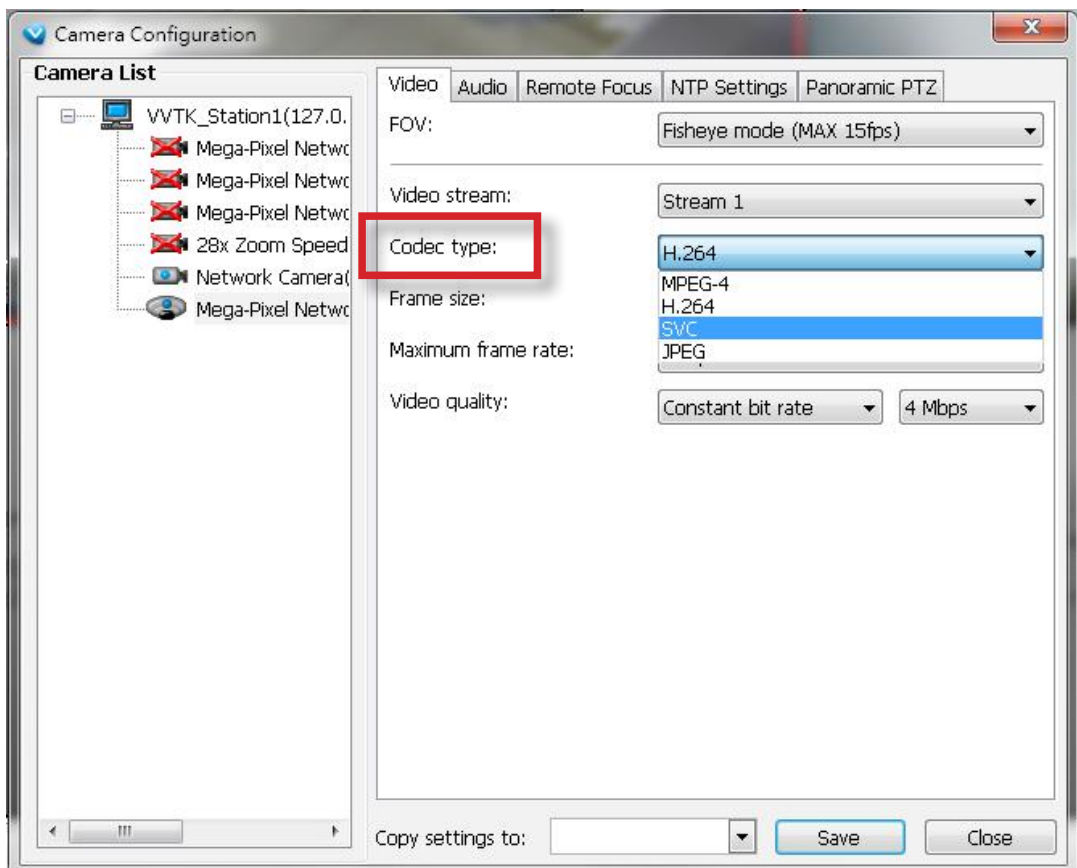

2. Right-click on the view cell of an SVC-enabled camera. Select **SVC fps adjust bar**.

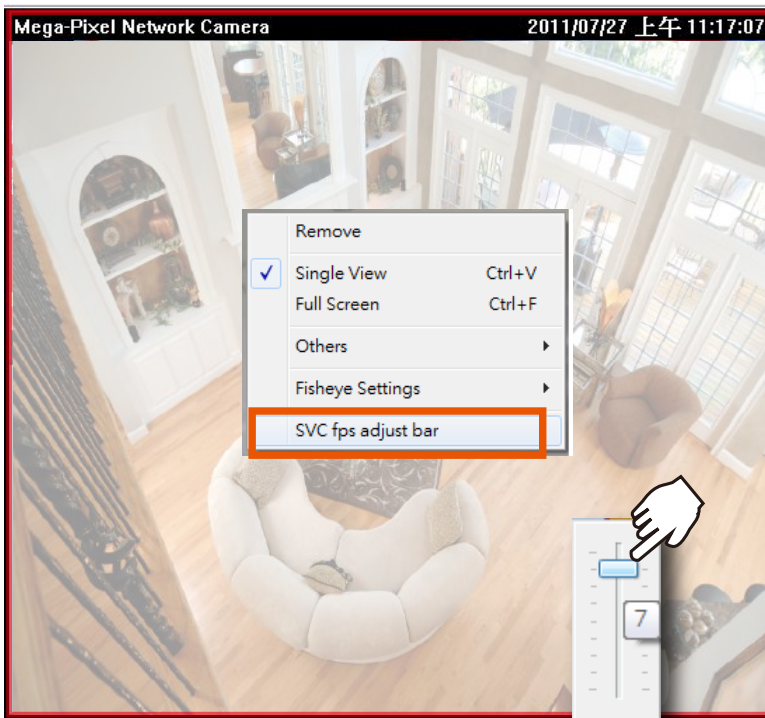

3. A slide bar will appear above the view cell. Click and drag the slide bar. A numeric indicator will display the current selection. See below for the frame rates represented by the numeric indicator.

Indicator	Frames per second (fps)
Maximum	30
7	26
6	22
5	18
4	12
3	8
2	4
1	1
Minimum	1/4

 **NOTE:**

The SVC feature only applies to H.264 and MJPEG streams. It is not applicable to MPEG-4 streams. Please refer to Configuration -> Media -> Video for individual stream settings.

If you have multiple SVC-enabled cameras, you can enable a collective setting via the **Adjust SVC level** button on the tool bar. The frame rate selected here will then apply to all view cells on the VAST LiveClient console.

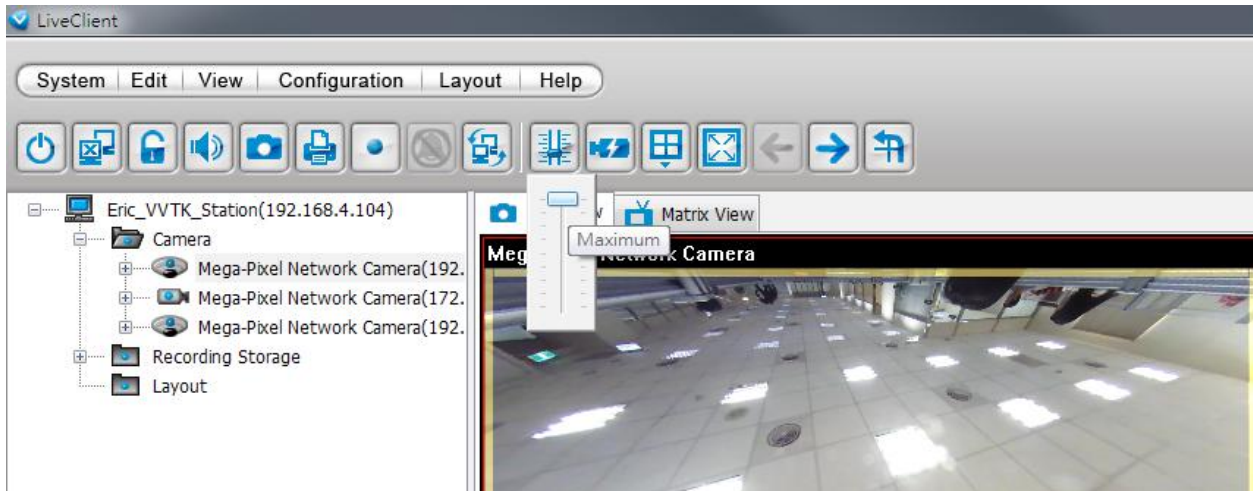

Please note that the SVC related setting can not take effect while the LiveClient station is running the Layout Rotation. Stop the layout rotation before configuring the SVC function.



*While you save your bandwidth for live viewing, you can still record full-frame-rate video by changing the recording setting. For example, you can enable resource-saving SVC on stream #1 and configure stream #2 to be recorded with full details, in terms of frame size, frame rate, and video quality.*

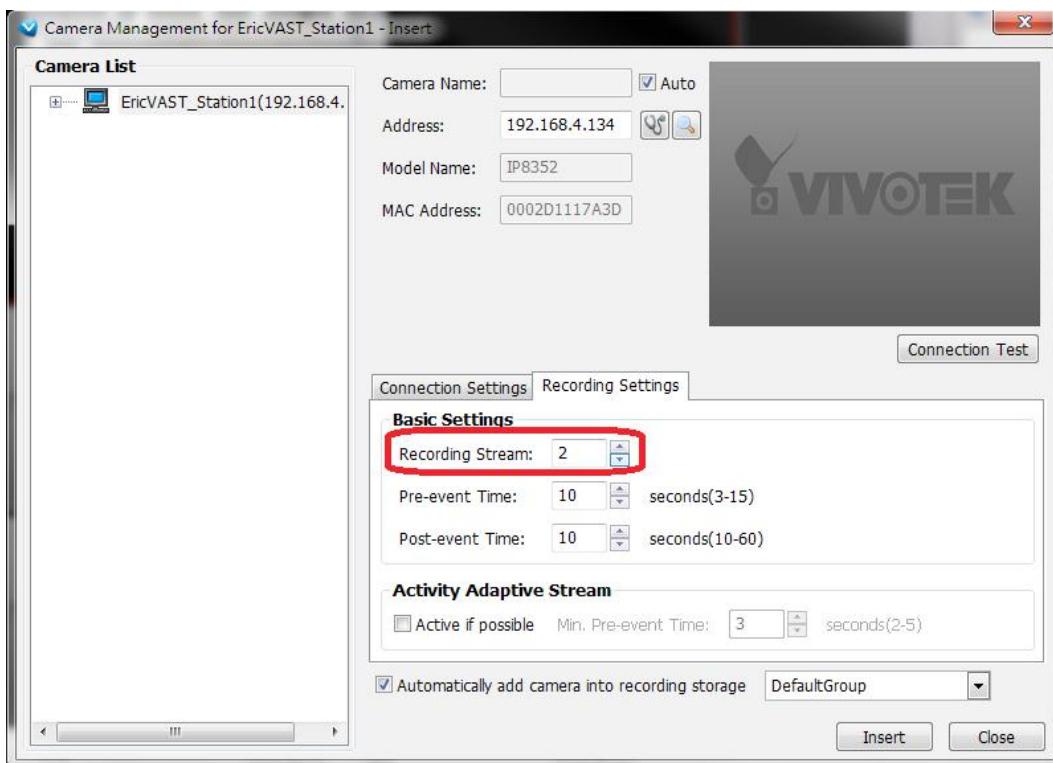

## Streaming URL

You can enter a camera's IP address to add a camera's RTSP streaming for live view and recording, and playback.

To insert a camera using the URL-like command,

1. Select the camera Brand as "URL."

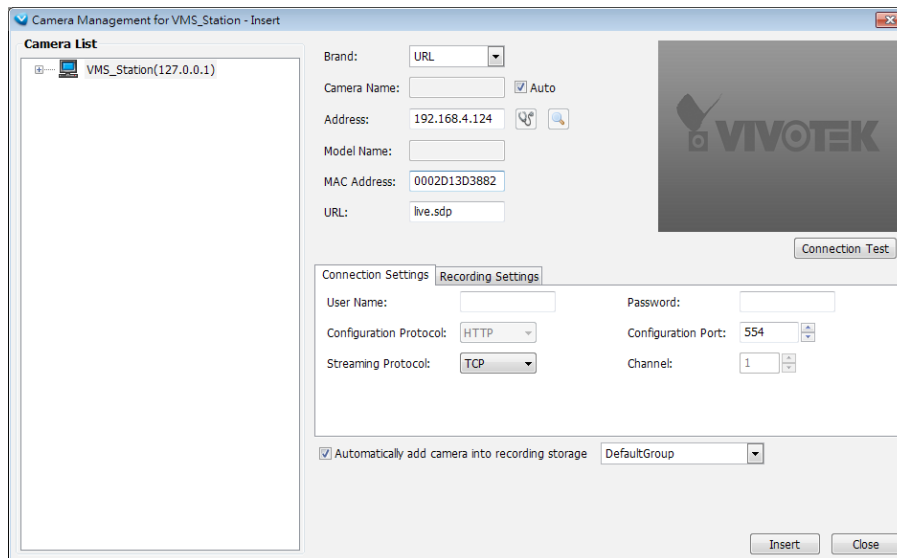

2. Enter the camera's IP address.
3. Enter the camera's MAC address as printed on the camera label, or one found by the Shepherd utility.
4. Enter "554" in the Configuration port.
5. Enter "live.sdp" in the URL field, as this is part of the original RTSP streaming command: "rtsp://172.18.204.58:554/live.sdp". If streaming stream #2, enter live2.sdp.

Note that the free 32 channel licenses does not apply when inserting a camera using the URL command. Only the live view, recording, and playback functions are supported if thus connected. All other functions are not supported, such as auto streaming size or changing to another video stream. Camera DI/DO is also not supported.

## Insert NVR (Network Video Recorder)

1. Before you can include an NVR system into your current configuration, you should enable the corresponding configuration on a web management console with the NVR system. In **Configuration > System > VAST**, click on the **Enabled** checkbox and enter a password for authentication.

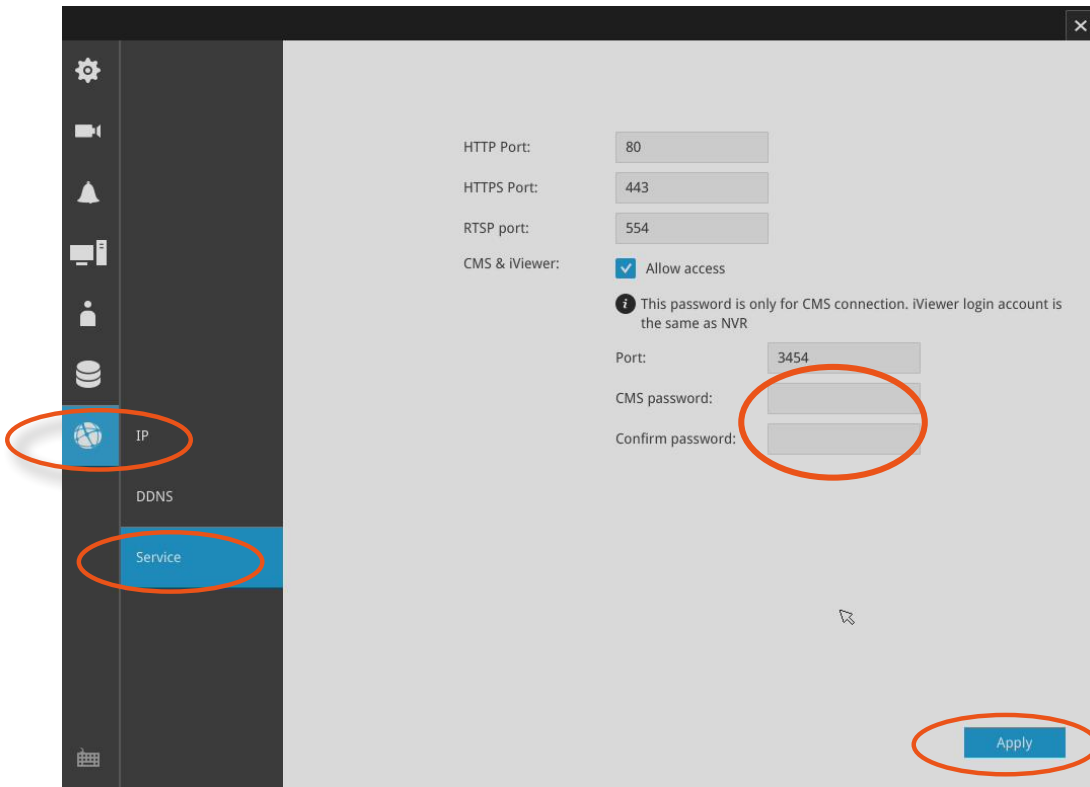

2. Return to your VAST management screen. Left-click to select your VAST station on the navigation panel, and then right-click to display and select "Station Management..."

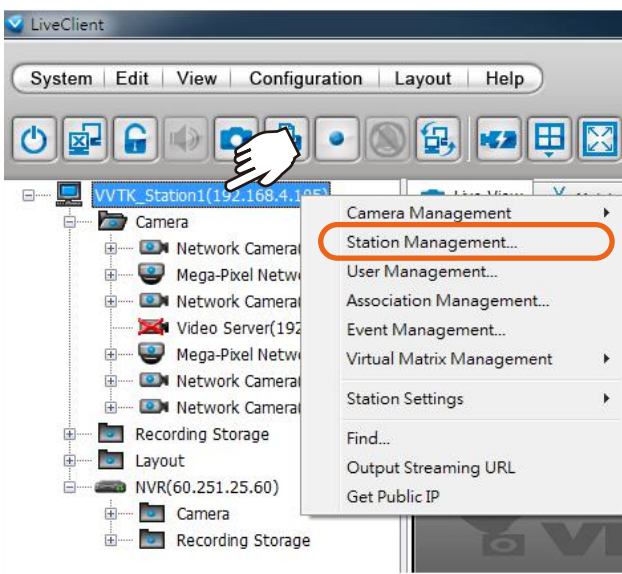



3. The Station Management window will prompt. Enter the **Address**, **Password**, and check if the **Communication Port** match that you set for the NVR. Click on the **List Sub-Station Hierarchy** button.

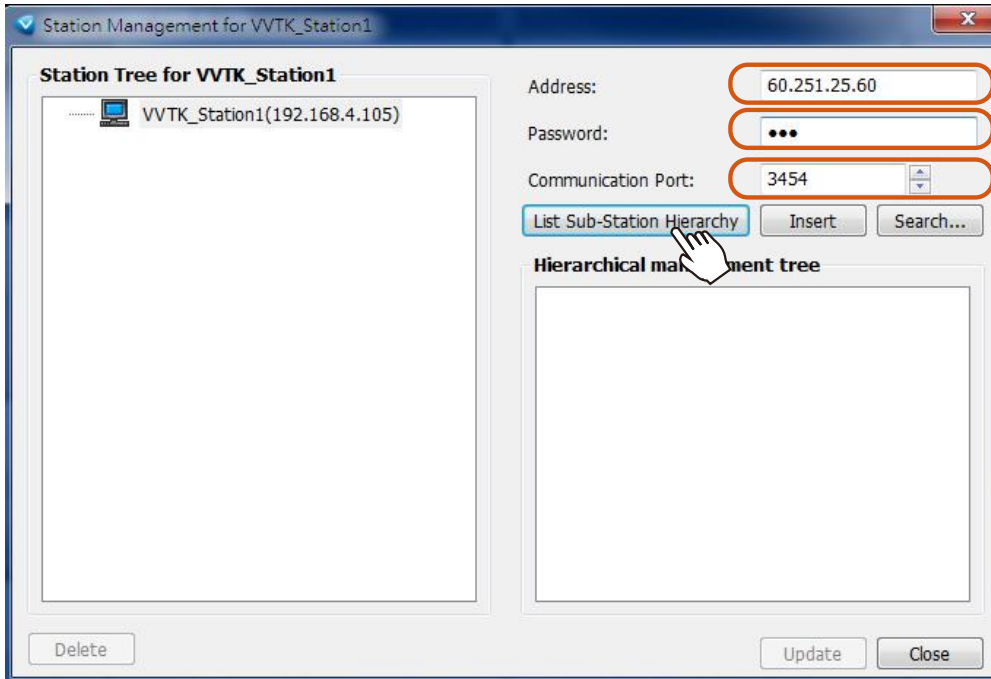

After a brief delay, the NVR server will be listed in the column. You may also use the **Search** button to locate similar devices if they are reachable in your local area network.

4. You can then click the **Insert** button to add the NVR server to your configuration. When done, click the **Close** button.

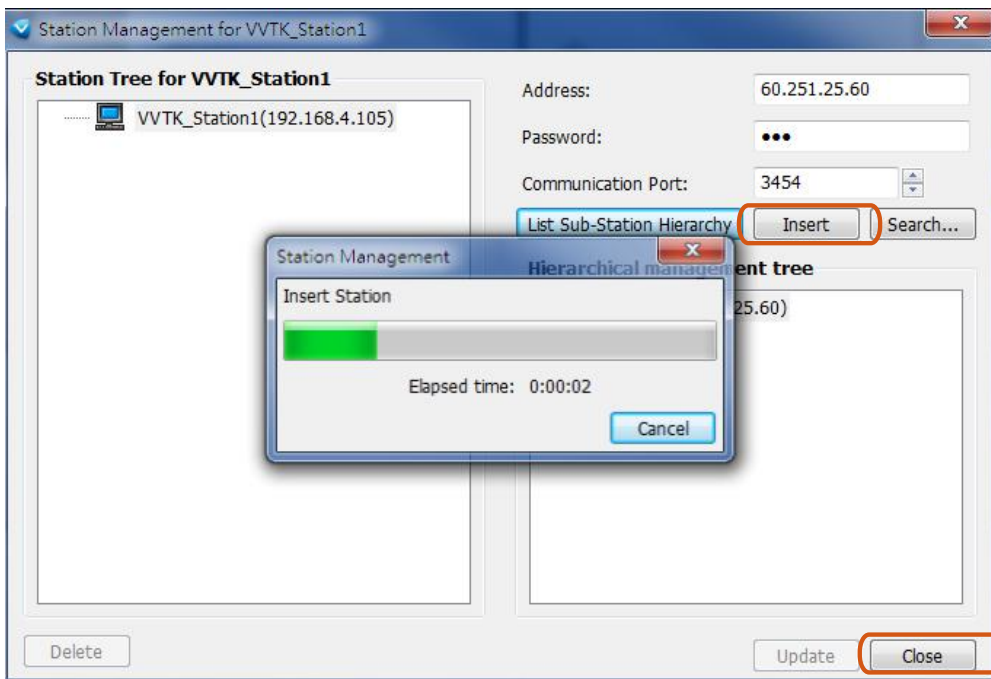

5. The NVR will appear in the navigation panel along with its subordinate cameras.

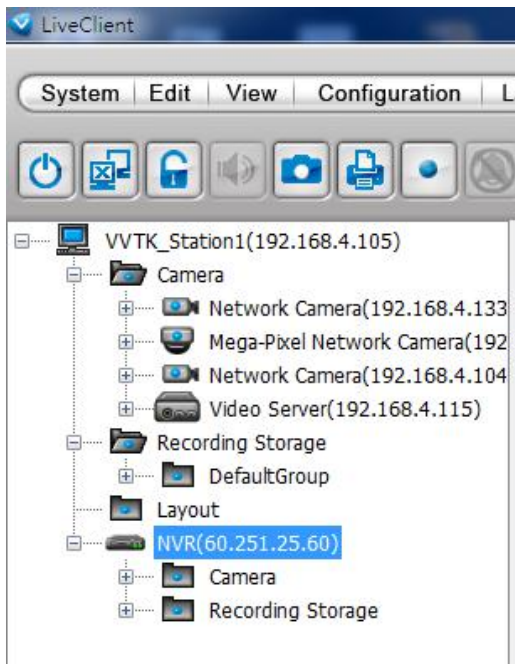

To enable the detection of NVR DI/DO signals,

1. Enter **Configuration > Client Settings > General Settings**. Select "**Keep detecting DI/DO status**."

Note that you should restart the VAST console for the configuration to take effect.

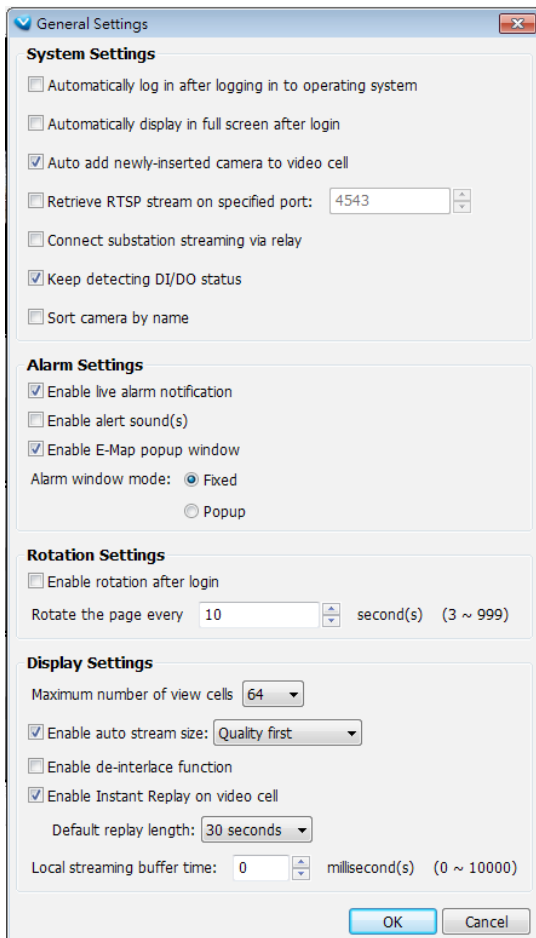

The NVR's DIs and DOs will be listed on the device tree. Note that the DI/DO status is not supported by NVRs running an embedded VAST software.

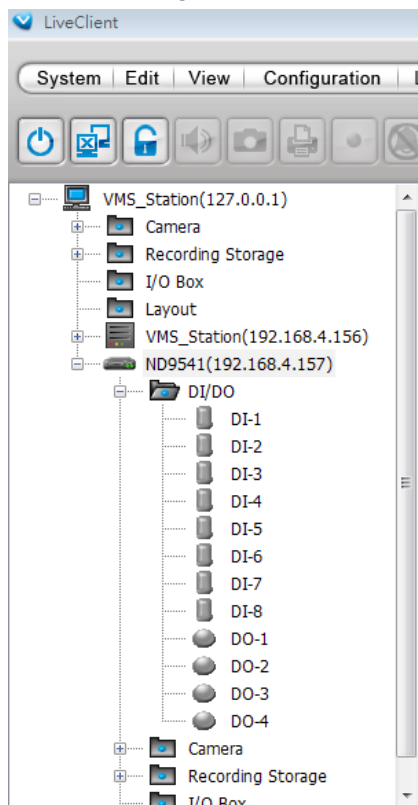

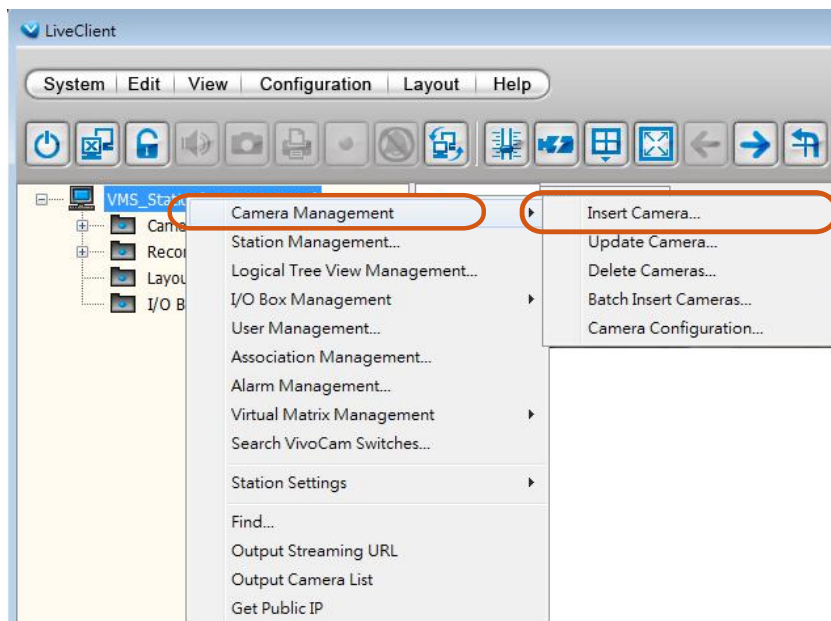

## Insert a Video Server

1. Left-click on your VAST station, and then right-click to display the **Camera Management** command. Let your cursor stay on the command for a second and then move to the **Insert Camera** command. Click on the command to open its configuration window.

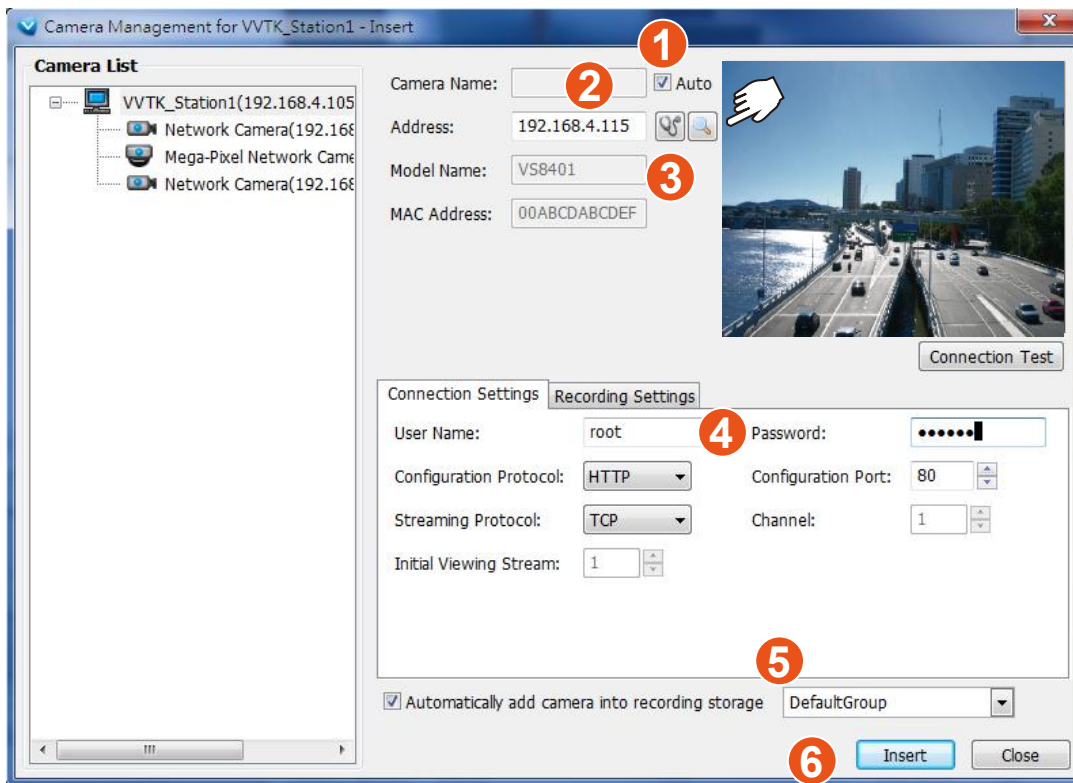

2. See below for the steps to insert a Video Server along with its subordinate cameras.



- 2-1. You can deselect the **Auto** checkbox to enter a name for the Video Server. If set to Auto and your video server already has a name, that name will be displayed in your device list.
- 2-2. Enter the **Address** of the video server - or - use the **Search**  button to open a Search window.
- 2-3. If you enter its address and it is found after you click on the **Detect Model**  button, its **Model Name** and **MAC Address** will be listed.
- 2-4. Before you click the Detect button, you should enter the **User Name** and **Password** for access to the video server. You should also confirm the **Configuration Protocol**, **Configuration Port**, **Streaming Protocol**, and the rest of the networking parameters.
- 2-5. You may select or deselect the checkbox in front of the recording storage option - or - use the pull-down menu to select the default group or a pre-configured storage group.  
You might use the **Connection Test** button to verify if the stream comes from the device you prefer.
- 2-6. Click **Insert** to include the video server to your configuration.

The Video Server should now be listed on the Camera List.

You can also use the **Search** button to poll the local area network for VIVOTEK's devices. You can select to list all cameras or list those that have not been included in your current configuration.

Click on a device, and its detailed information will immediately appear in the **Camera Management** window on the left. For recording settings, please refer to page 47 as previously described.

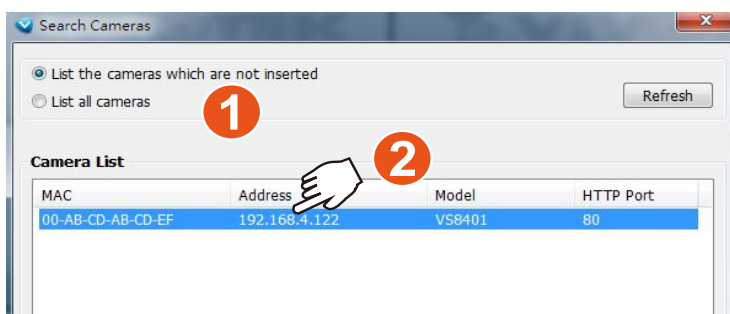

## Update Devices

Please follow the steps below to update a device via Camera Management window:

- Click **Configuration > Camera Management > Update Camera** on the menu bar (or **right-click** the device/station, then select **Camera Management > Update Camera**).
- The **Camera Management - Update** window will pop up. The device tree managed by the station will be displayed in the left Camera List window.
- Select a device from the list you want to update. Its related information will automatically be displayed in the corresponding fields in the Camera Management window. Then you can modify **Connection Settings** and **Recording Settings** of the device.
- After modifying the settings, you can click **Connection Test** to preview the live video from the device.
- When all settings are completed, click **Update** to enable the settings.

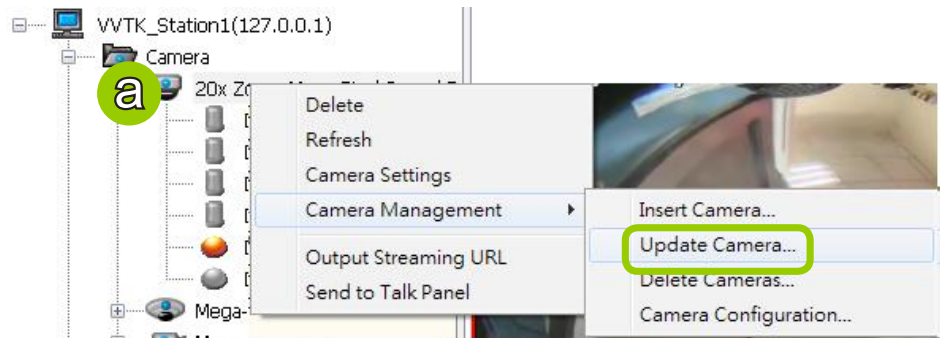

b

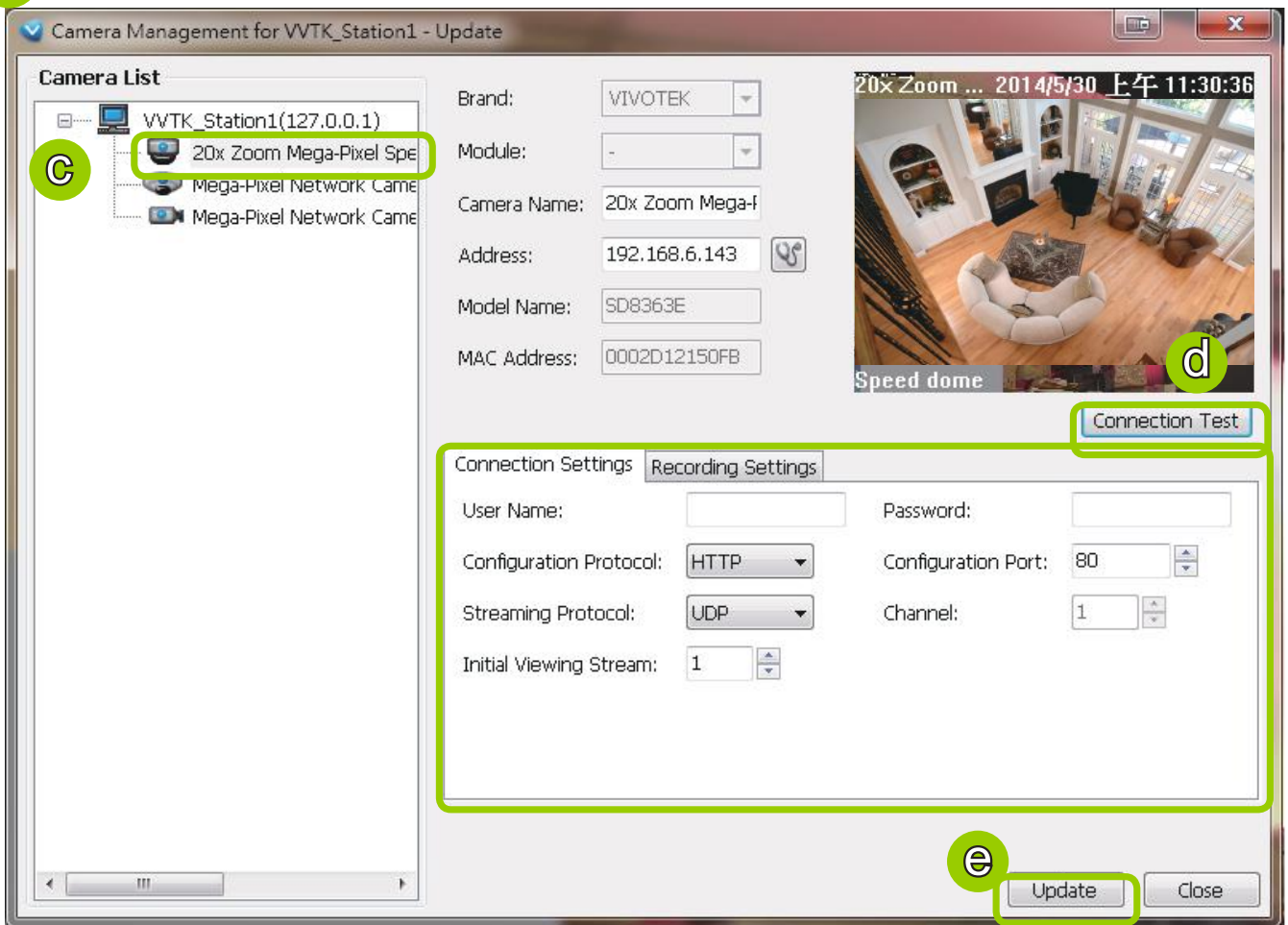

## Delete Devices from the VAST Server

### Delete a device:

**Right-click** the device on the device tree, then select **Delete**. A dialog box will pop up. Click **Yes** to delete the device along with the recorded data; click **No** to delete the device but retain the recorded data; click **Cancel** to cancel the delete action.

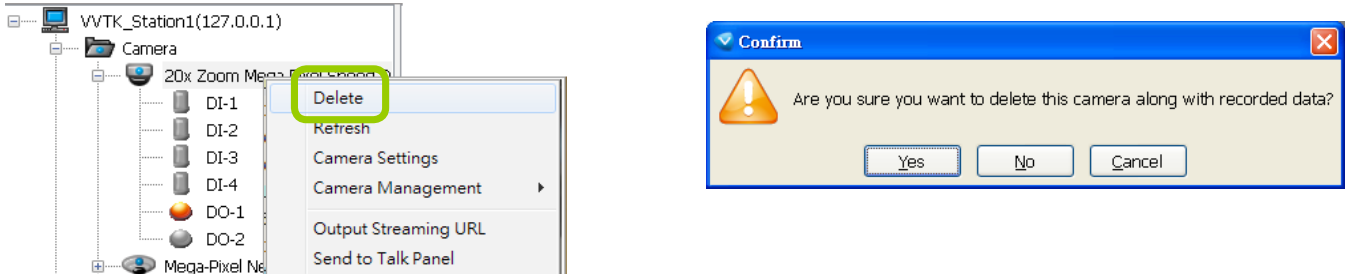

### Delete more than one device at a time:

- Click **Configuration > Camera Management > Delete Cameras** on the menu bar (or **right-click** the device/station, then select **Camera Management > Delete Cameras**).
- The **Delete Cameras** window will pop up.
- Select the devices you want to delete from the list, then click **Delete**.
- A dialog box will pop up. Click **Yes** to delete the device along with the recorded data; click **No** to delete the device but retain the recorded data; click **Cancel** to cancel the delete action.
- When completed, click **Close** to exit the **Delete Cameras** window and return to the main window. The deleted device will disappear from the station.

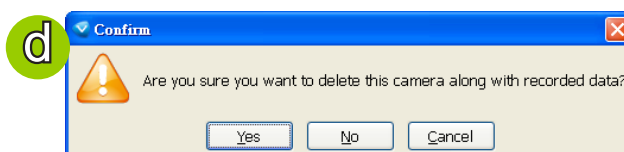
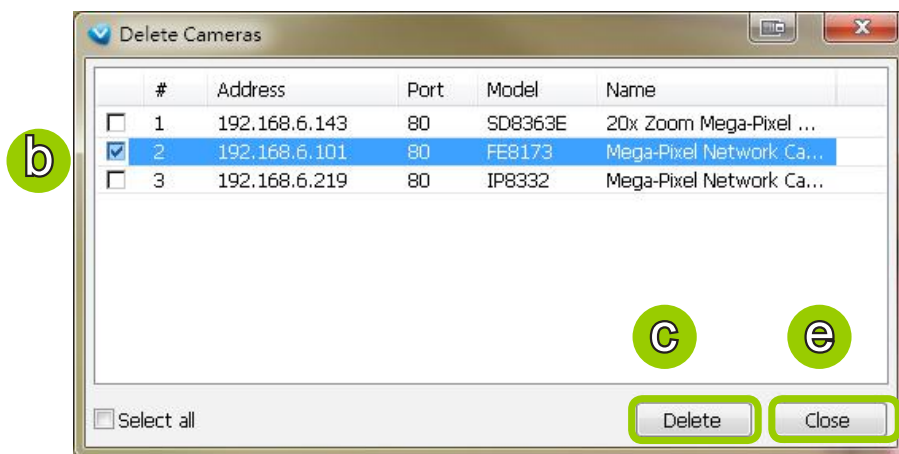
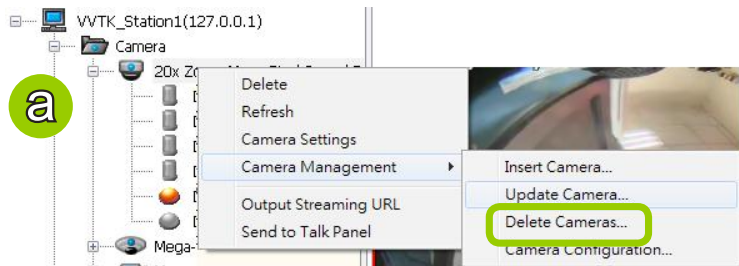



- IP with prefix: Type in the prefix of the IP address to narrow down the list.

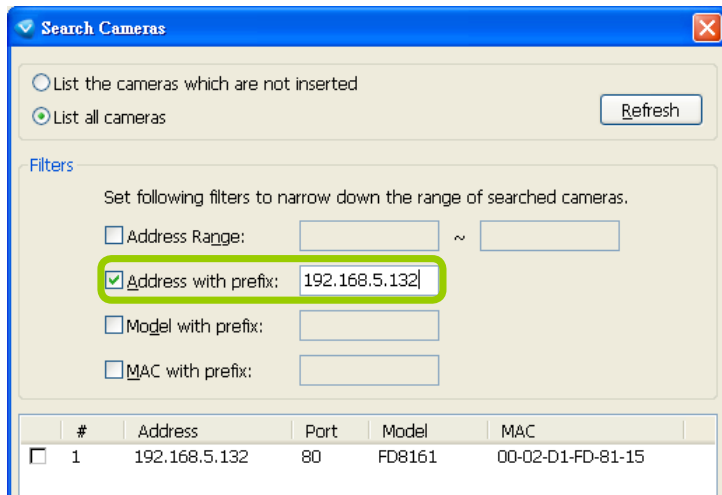

- Model with prefix: The user can type in the prefix of the model name or the complete model name of the cameras to narrow down the list.

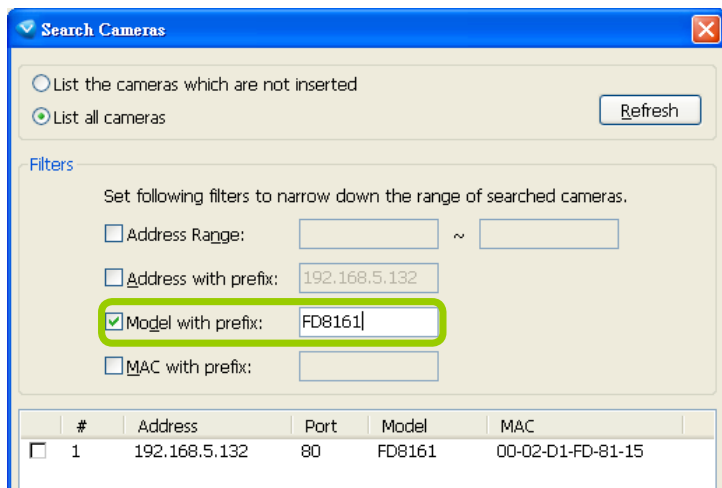

- MAC with prefix: You can type in the prefix of the MAC address of the cameras to narrow down the list.

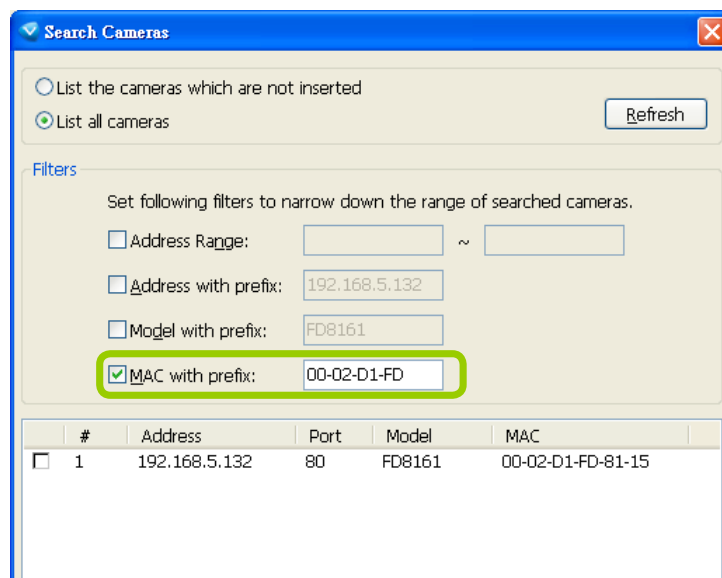





- g. At the bottom of the window, there is a field for you to alter the camera settings including Connection Settings and Recording Settings. You can apply the new settings to each camera on the list, or click **Apply to All** to apply the same configurations to all the cameras. For more information about Connection Settings and Recording Settings, please refer to Insert Device on page 45 for detailed information.
- h. Specify host: If you want to add a camera to the list, click **Specify Address** to directly add a wanted camera. Click **Add** after filling in the correct information. The camera will be added to the list of the Batch Insert Camera window.
- i. By default, all inserted devices will be applied to the default recording group. Deselect the **Add** checkbox if you do not want to assign the selected devices to the default recording group.
- j. Click **Insert** when all the settings are done. Cameras will be added.

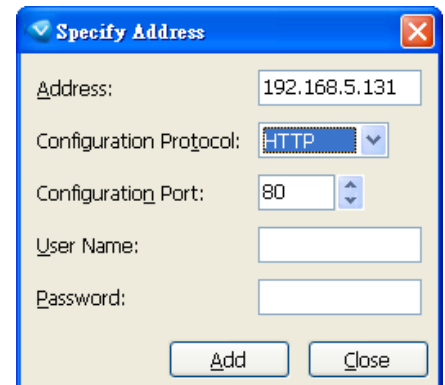

*When you modify the camera settings, and when the connection information (User Name, Password, Configuration Protocol, Configuration Port, and Streaming Protocol) does not match the current network environment, the camera will be disconnected and the status of the camera will become "Camera cannot be found" as shown below.*

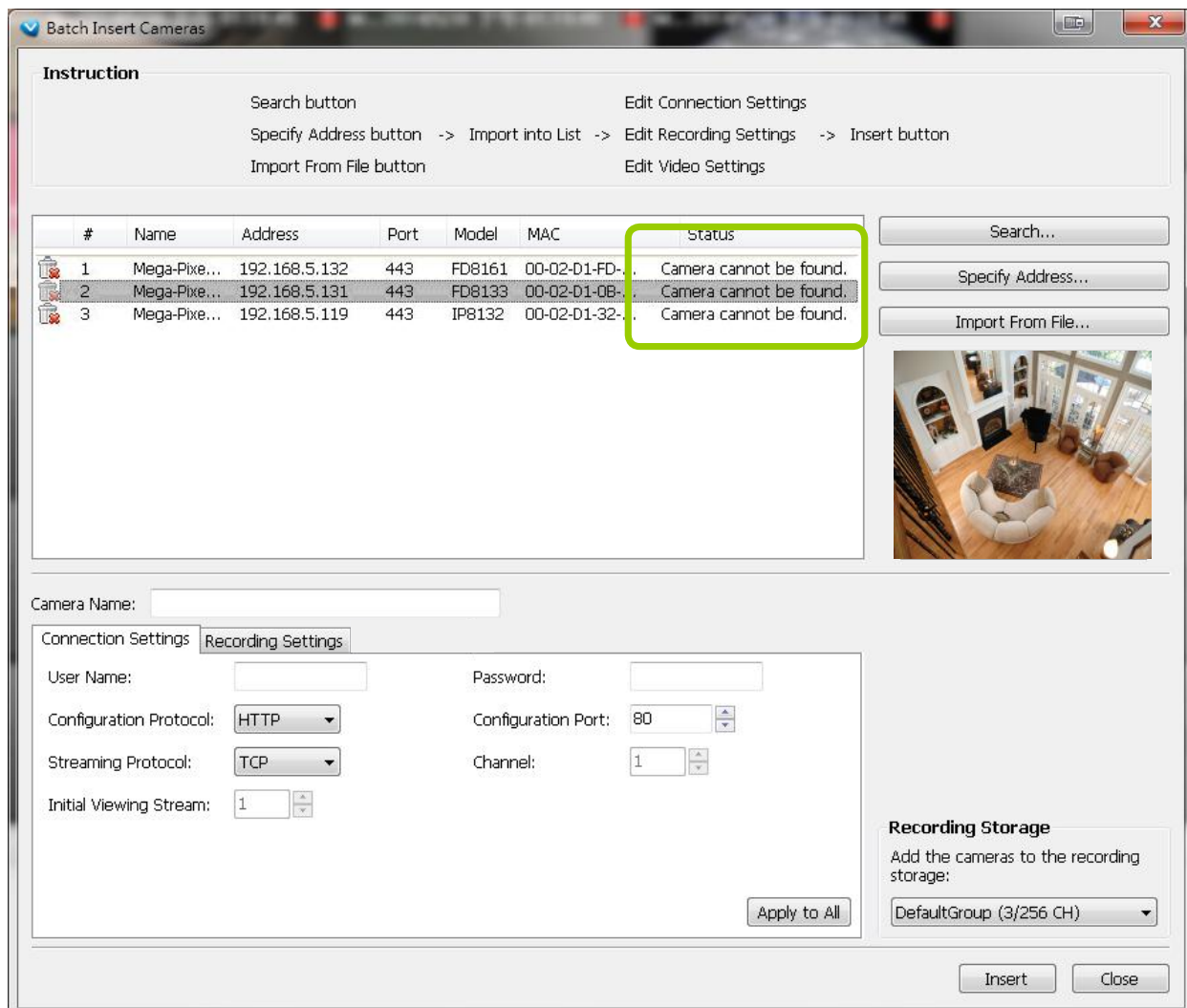



---

You can enter a User name and Password and use the Apply to All button to apply this combination to all selected cameras. This way, you do not need to change the user name and password for every individual cameras.

## Camera Configuration

The **Camera Configuration** function group provides immediate access to the video streaming and other settings without the need to open a web console. The function group is accessed by selecting a camera on the device tree, and right-click to select **Camera Management > Camera Configuration**. If you have new VIVOTEK cameras and the VAST server can not recognize their features, see page 33 for how to update camera information using the Device Pack update.

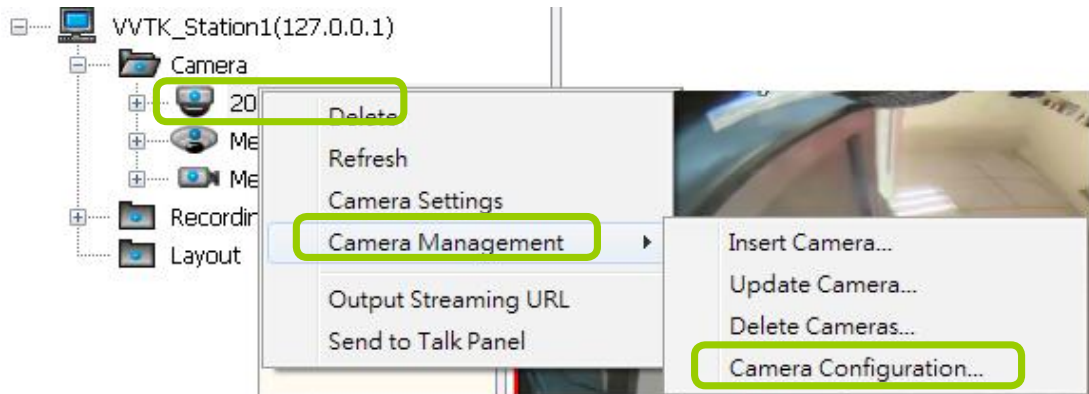

### FOV (Field of View)

The FOV configuration is available for 5 megapixel cameras (such as IP8372 and IP8172P), which allows you to crop a portion of the image captured by the sensor. The FOV setting applies in the scenario where you do not need all of the video a camera can capture. For example, when shooting a parking lot where the upper half of the image is the sky. Cropping a field of view can help save bandwidth and reduce the requirements for storage space.

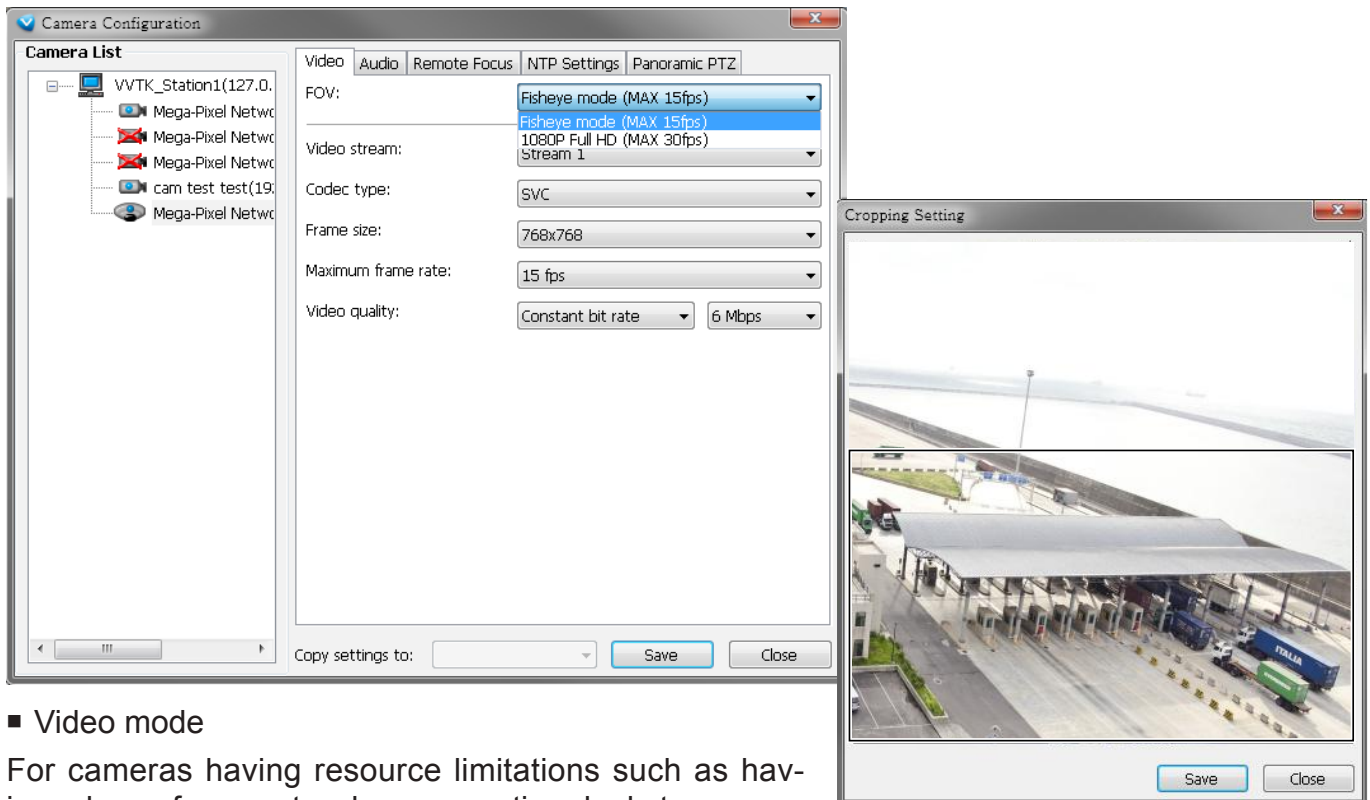

### Video mode

For cameras having resource limitations such as having a lower frame rate when supporting dual streams, or lower frame rate when using the Rotation mode, its video mode is automatically displayed in the Video window.

■ Video

This tabbed window provides access to the selection of the live view stream, its compression codec, frame size, max. frame rate, and video quality. Note that the **Constant Bit Rate** methodology can be used to ensure that the size of video stream does not exceed a preferred threshold, regardless of the complexity or the changes of pixels in the image. You should use a maximum of 1080P as **frame size** and 6Mbps as **constant bit rate** for video streams managed by this system.

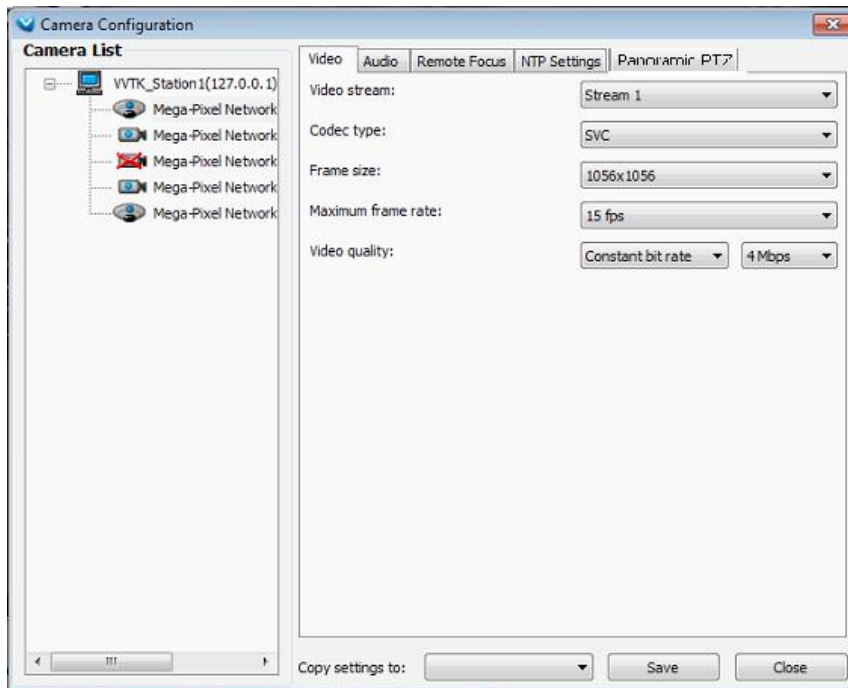

If your camera supports the **Smart Stream** function, the related options will be available with the Video quality. Note that only the **Auto mode** option will be available.

**Auto:** When set to Auto, only the moving objects and the areas around them will be displayed with the Foreground quality. The rest of the screen will be displayed with the Background (lower) quality.

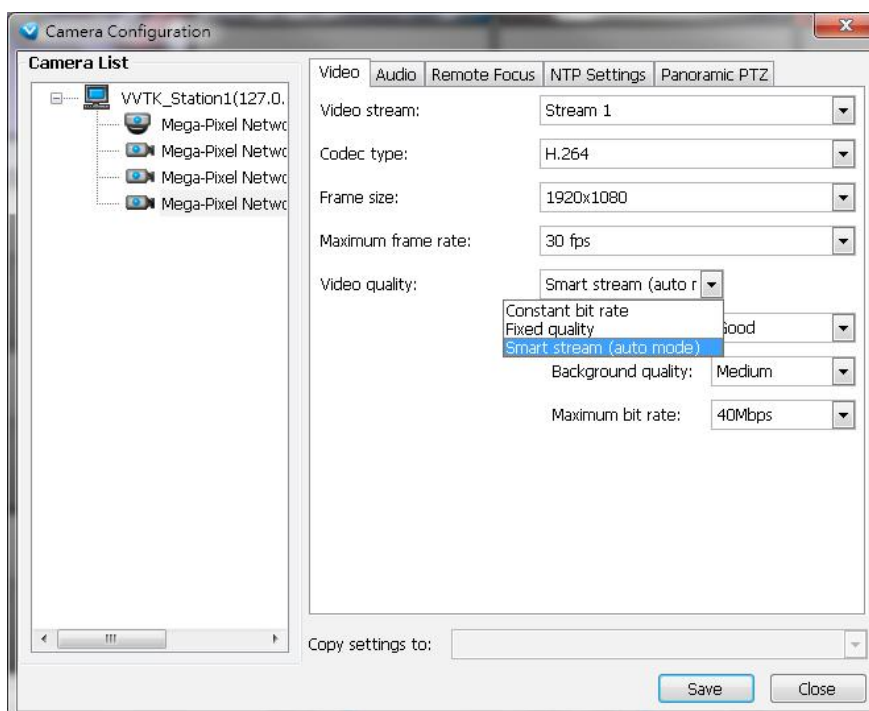

■ Audio

If audio feed is preferred, configure the audio codec type, sampling bit rate, and operating mode in here.

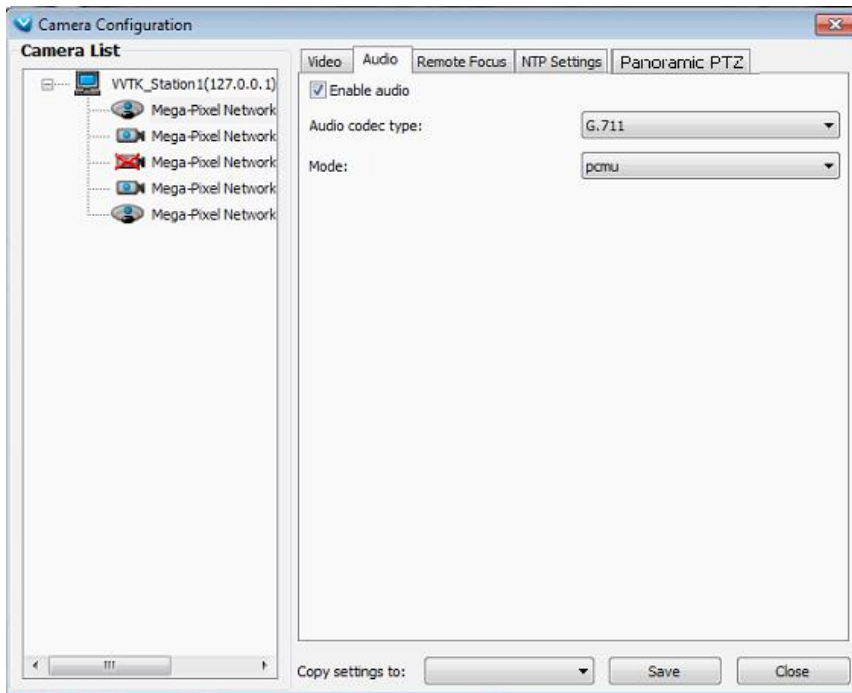

### ■ Remote Focus

For cameras supporting the remote focus feature, such as the FD8362E that comes with a motorized lens, this window provides finetune buttons and full-range scan function to help reach the best image focus.

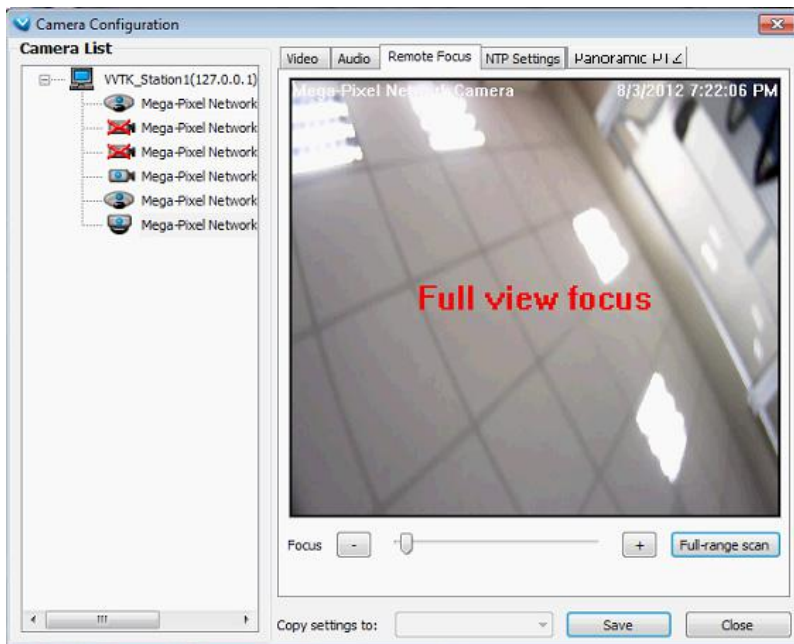

### ■ NTP Settings

If cameras' real time clocks are set to be synchronized with a time server, enter the NTP server's address or domain name and specify an Updating interval. If you select the "Synchronize camera time with system automatically" checkbox during the initial setup, the NTP server IP will be the VAST server's IP.

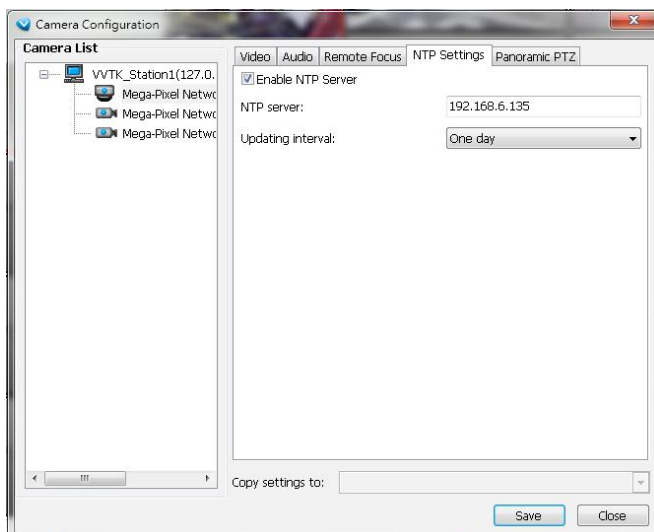

Always remember to **Save** your configuration before leaving this window. You can also use the "**Copy settings to**" button below to duplicate your current settings to adjacent cameras.

■ Panoramic PTZ

Please refer to **Appendix B** Panoramic PTZ configuration on page 288 or the Panoramic PTZ Installation Guide for more information.

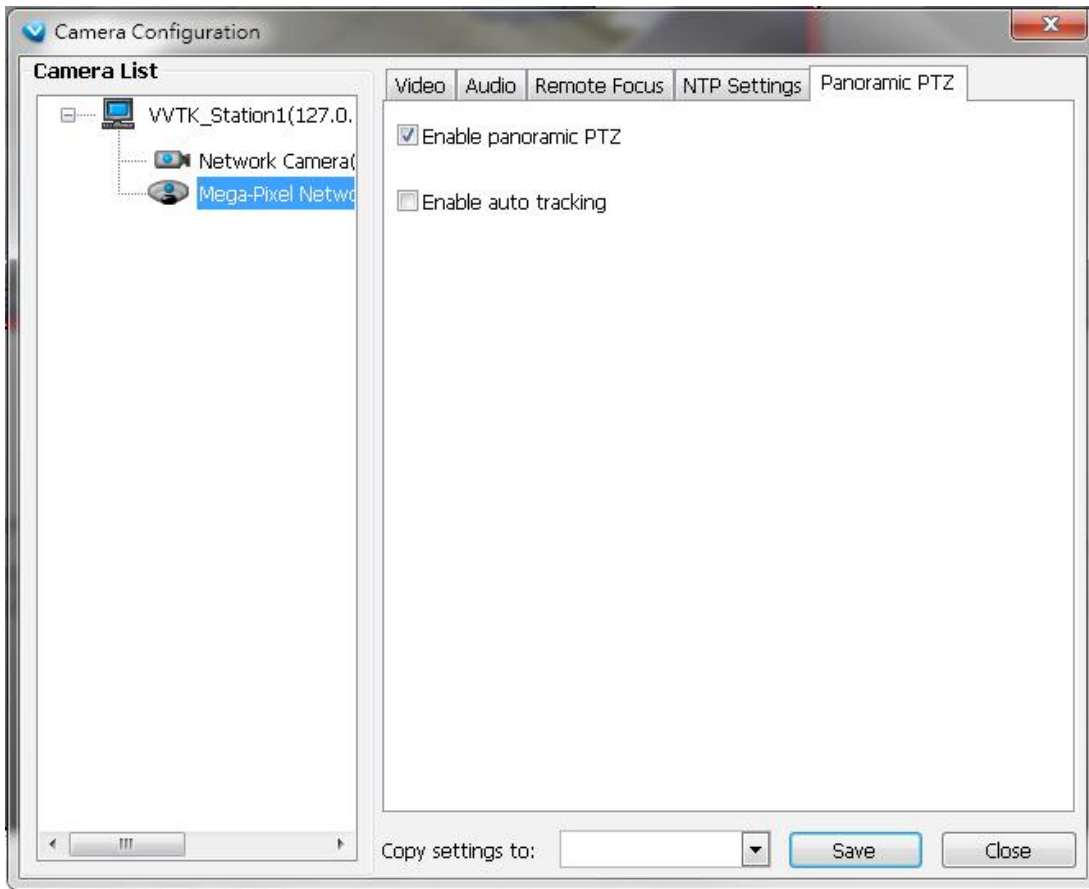



## View Live Videos

The server will automatically add a newly-inserted device to the video cell for live viewing. You also can **double-click** the target device or **drag-and-drop** the target device from the hierarchical management tree to the video cell.



## Dual / Multiple Streams

For dual-stream devices, you can **right-click** on the focused cell to select stream 1 or stream 2. For multiple-stream devices, you can select from stream 1 ~ stream 4.

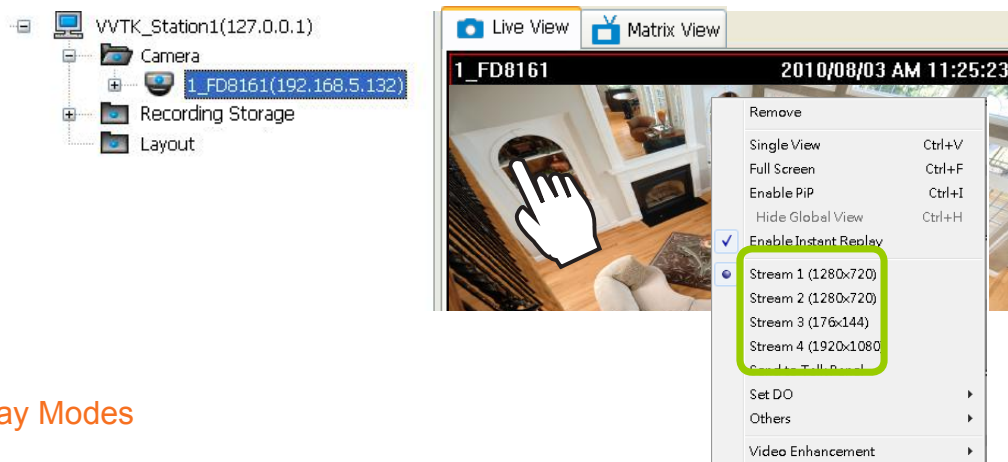

## Fisheye Display Modes

By default, a circular view is displayed when a fisheye camera is successfully connected. To display Regional, Panoramic, or the combination of different views, **right-click** on a fisheye camera's live view to display the associated commands. The display modes available are: 1O (Original), 1P (Panoramic), 1R (Regional), 2P (2 Panoramic), 1O3R (1 Original & 3 Regional), 4R (Quad Regional), 1O8R (1 Original & 8 Regional), and 4R Pro (4 Proactive) modes.

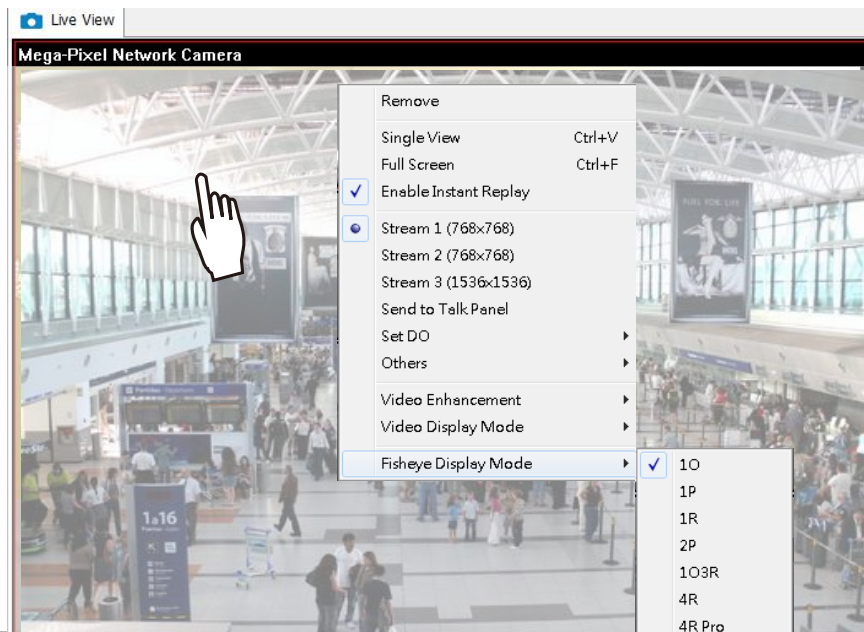

**Fisheye Display Modes:** below are conceptual drawings for different display modes.

**1O** (Single Original) Display mode:

An **Original** oval view covers the hemisphere taken by the fisheye lens.

**1O View (Original View)**

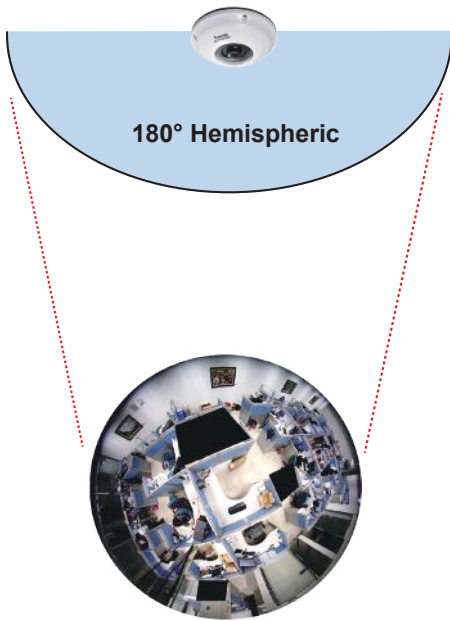

**1R** (Single Regional) Display mode:

A **Regional** view crops a portion of the hemisphere as a region of interest. You can zoom in or out or move the view area elsewhere from on the regional view.

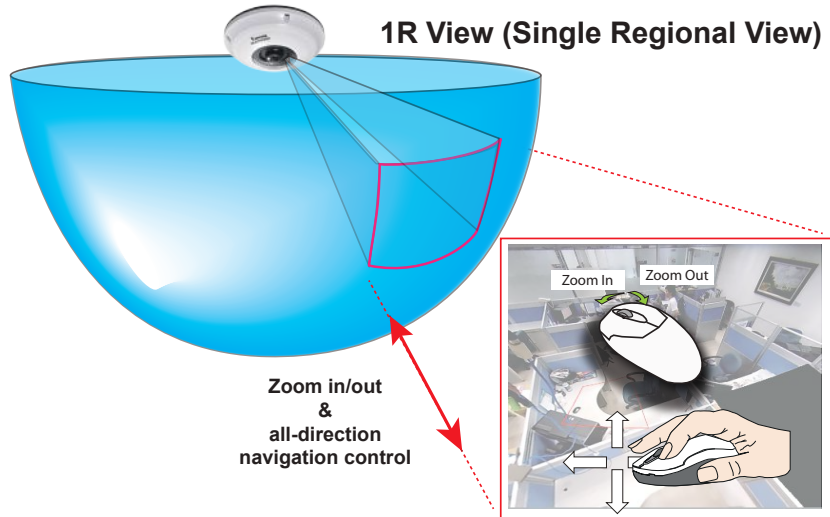

A Regional view is dewarped, by correcting images from the distorted oval view to a rectangular and visually proportional image.

**1P** (Single Panoramic) Display mode:

With image correction algorithms in firmware, the hemispheric image is transformed into a rectilinear stripe in the 1P display mode. Viewers can use the PTZ panel or simply use mouse control to quickly move through the 360° panoramic view.

Note that the 1P view is apt for an overview, the Zoom in/out function does not apply in this mode.

**1P (Panoramic) Mode Screen Control**



**2P** (2 Panoramic) Display mode:

Two dewarped rectangular views are placed one on top of another each showing 180 degree of panoramic view. The 2P view looks like the upper view shows the front of hemisphere, and the lower view the rear half of the hemisphere.

**2P (Panoramic) Mode Screen Control**

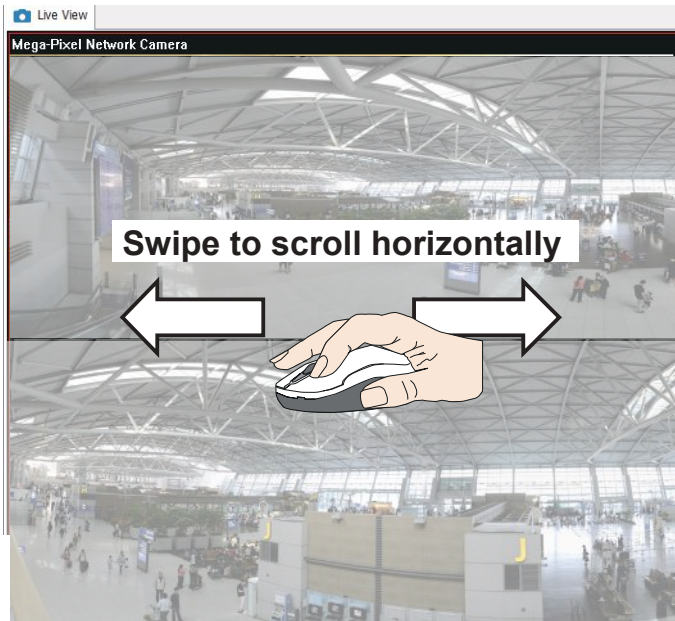

**1O3R** (One Original & 3 Regional) Display mode:

Fisheye cameras also support the display of multiple regional views taken from within the same hemisphere, and they can be displayed with or without an Original view in its view cell.

**3R View (Regional View)**

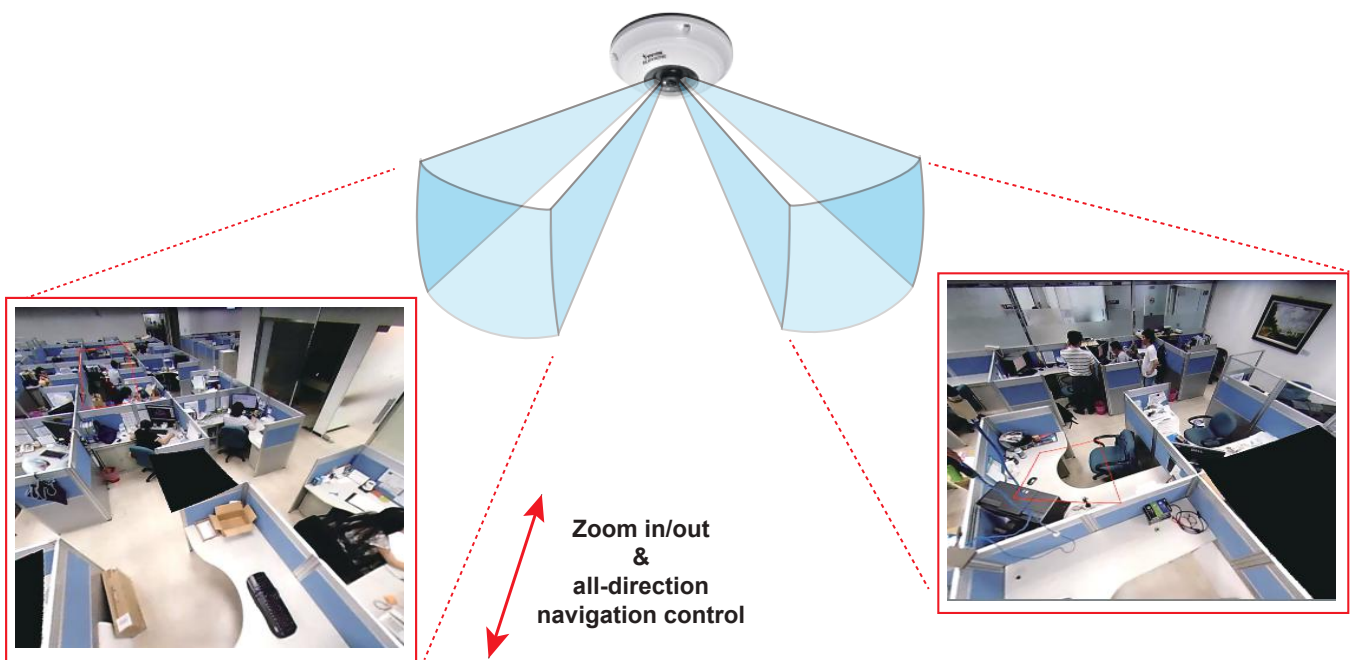

\* Only two regional views are shown for simplicity reason

## PTZ Mouse Control

The "Mount type" setting also determines the display modes available to your display modes. Please refer to fisheye camera's User Manual for more information.

A highly versatile mouse control is implemented with fisheye cameras. The same control takes effect on a browser management session, on the LiveClient utility, and even on a video playback screen. See the drawing below for how it works.

You can click and hold down the left mouse button to quickly swipe through the field of view, change the view angle, or use the mouse wheel to zoom in/out on a region of interest. However, the PTZ mouse control is only available in the **"R" (Regional) mode**. In the **Panoramic mode**, you can only scroll horizontally across the 180° or 360° panoramic view.

### 103R (Original & Regional) Mode Screen Control

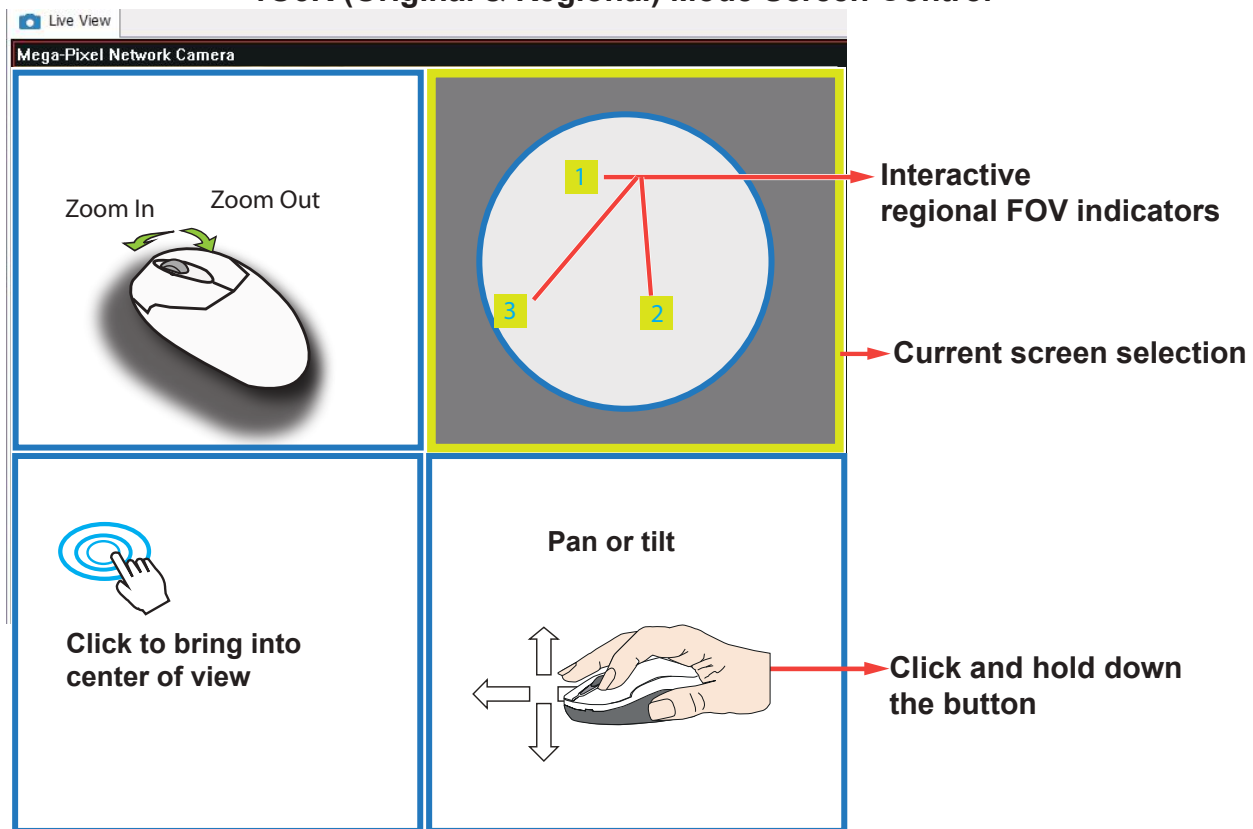

The various display modes require the support of D3D technologies by your display card on the LiveClient or Playback station. Most off-the-shelf display cards today support this feature.

The onscreen mouse control is very agile. Therefore, use the PTZ panel for more delicate moves in a field of view. **Pan** and **Patrol** moves are also supported if you have configured preset PTZ positions in the camera's firmware. Note that the Pan move takes place in the Panoramic and Regional views, while the Patrol function through preset positions applies only in the Regional views.

Below are the conceptual drawings for other display modes. The available display modes can differ with different mount types:

Regular: 1O, 1P, 1R, 1O3R, 4R.

Wall mount: 1P2R, 1P3R.

For more information, you can refer to fisheye camera's user documents.

**4R** (Quad Regional) Display mode:

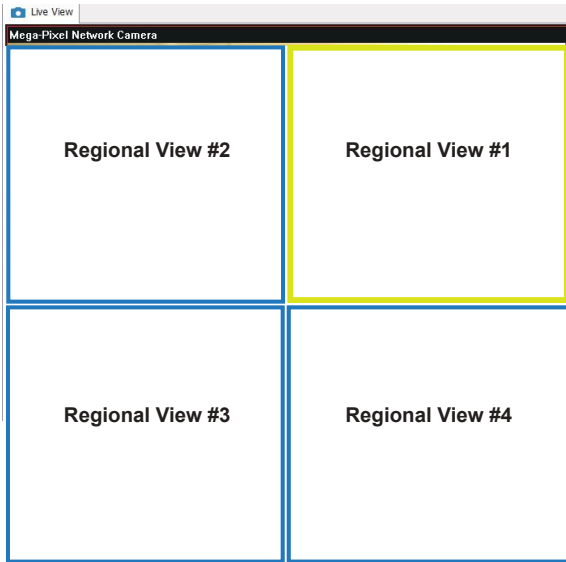

**4RPro** (4 Regional Proactive) Display mode:

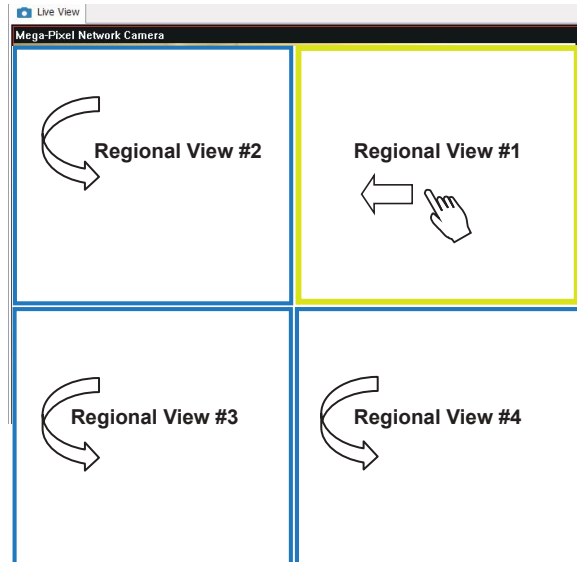

**1O8R** (One Original & 8 Regional) Display mode:

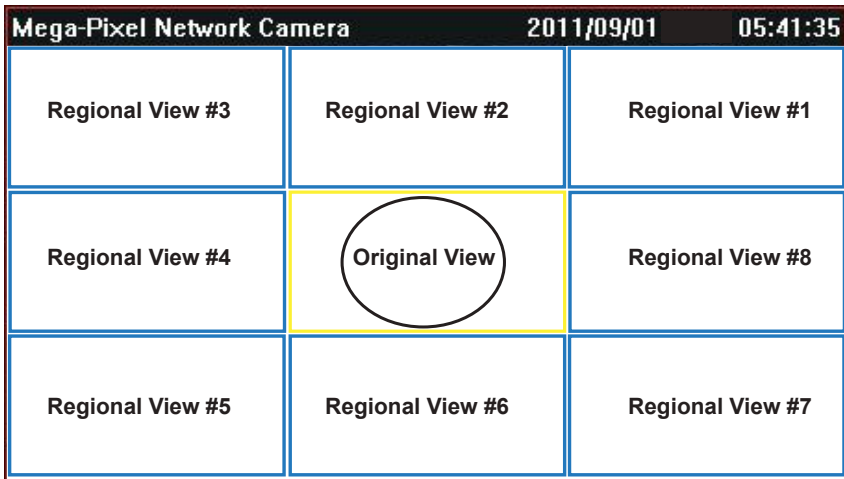

## Refresh

**Right-click** the device, then click **Refresh**, the camera information will be refreshed from the server.

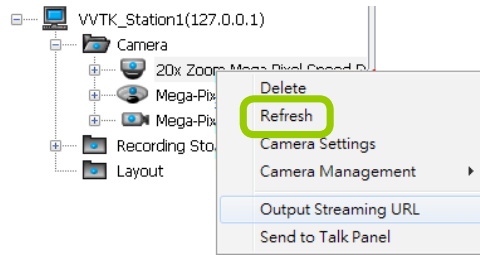

## Streaming Server

**Right-click** the station or the device and click **Output Streaming URL**. A .txt file with streaming URL will pop up. Then you can use this URL to link to the live streaming through QuickTime Player.

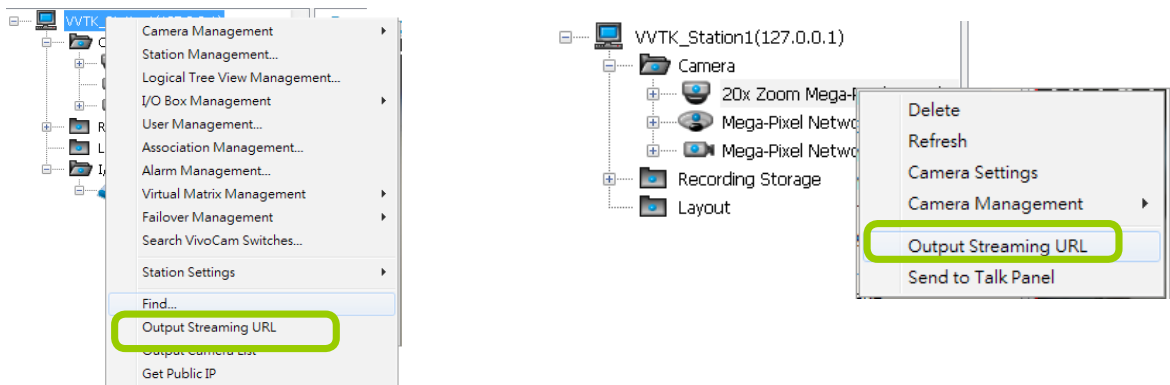

## Output Camera List

This command produces a text file containing cameras' brand name, IP address, and HTTP port information. The camera list file can later be used for Batch Insert function, Import from File.

## Get Public IP

If your access to Internet is via PPPoE, this function will display the public IP provided by your service provider. If your access to Internet is via a router, please consult your network administrator or consult your ISP for a valid public IP.

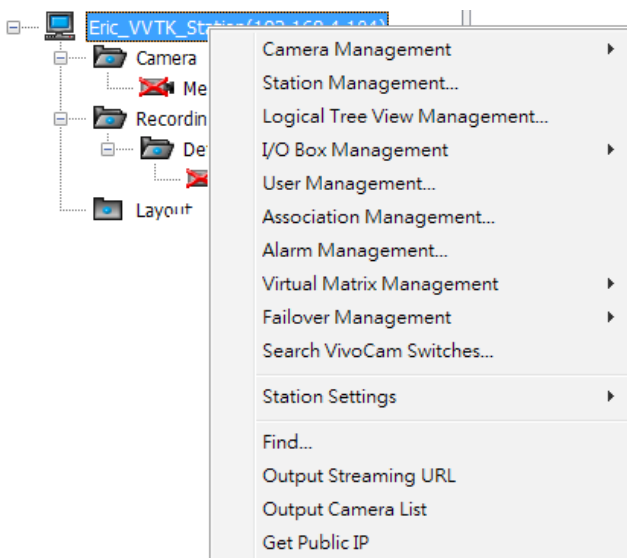

## Camera Settings

**Left-click** to select a camera, **Right-click**, and then click **Camera Settings** to open a browser's session to the camera.

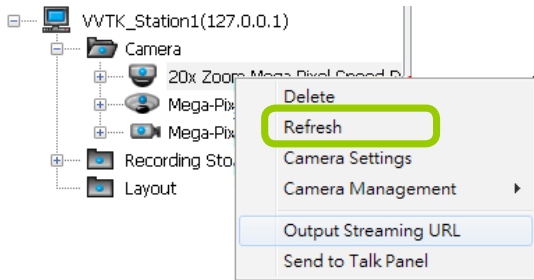

*You must have an IE browser rev. 7.0 or above for opening a management session.*

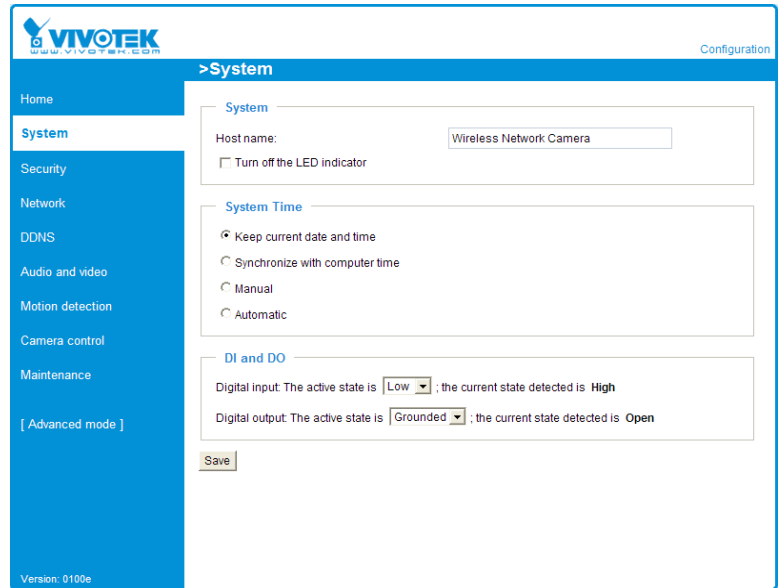

## Remove Live Video from the Video Monitoring Window

There are two ways to remove a live video from the video cell:

Method 1. **Right-click** the video cell and select **Remove**.

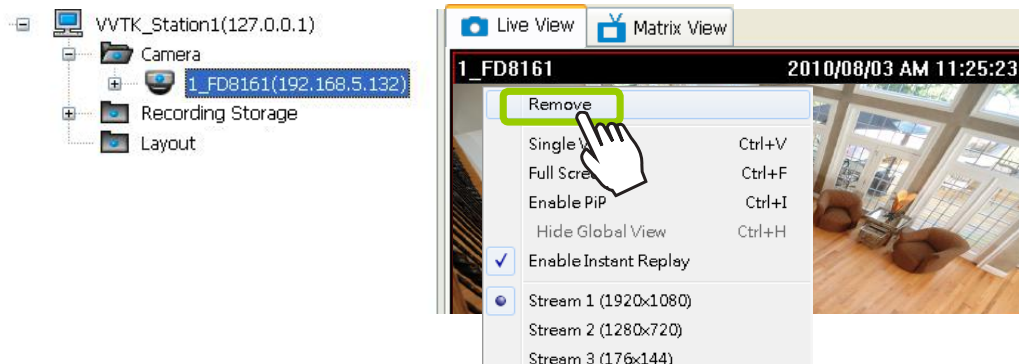

Method 2. **Drag-and-drop** the live view from the video cell to the hierarchical management tree window.



If you want to remove all live videos from the video cells, please click  on the menu bar.





## How to Change the VAST LiveClient Layout

### Changing the Layout of the Live Video Monitoring Window

VIVOTEK VAST LiveClient supports up to 32-CH simultaneous video viewing on a single monitor and allows you to change the layout of the live video monitoring window based on the number of inserted devices.

#### Switch Video Channels

To move a video channel to another empty video cell, **drag-and-drop** the view to the target video cell.





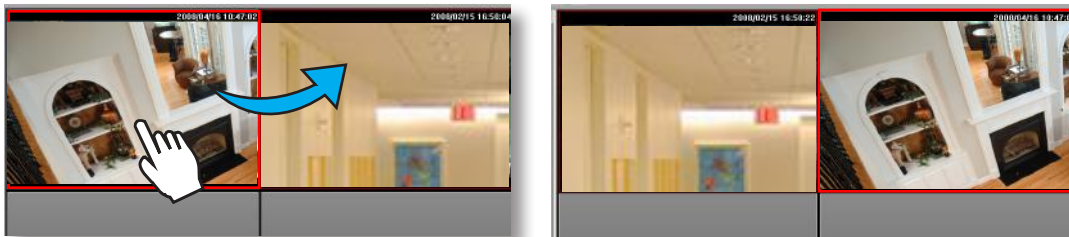











To switch two different channels, **drag-and-drop** one view to the other, then the two different channels will be switched to the opposite.



### Configure Layout Mode

Click the **Layout** button  on the quick access bar. Select a desired layout mode, and the layout window will be changed accordingly. Below we illustrate 15 types of layout modes and the corresponding page numbers:



Layout mode	Description	No. of Video page
1 x 1		32
2V		16
1P+2		20
3V		11
2 x 2		8
4V		8
2V+3		7
1 + 5		4
1P+6		8
3 x 3		3
1P+8		6
1 + 12		2
4 x 4		2
5 x 5		1
1 + 31		1

P-PTZ modes

More than 1 video page; rotation function is enabled

Only 1 video page; rotation function is disabled

### Configure Layout Mode

Click the **Layout** button  on the quick access bar. Select a desired layout mode, and the layout window will be changed accordingly. Below we illustrate 11 types of layout modes and the corresponding page numbers:

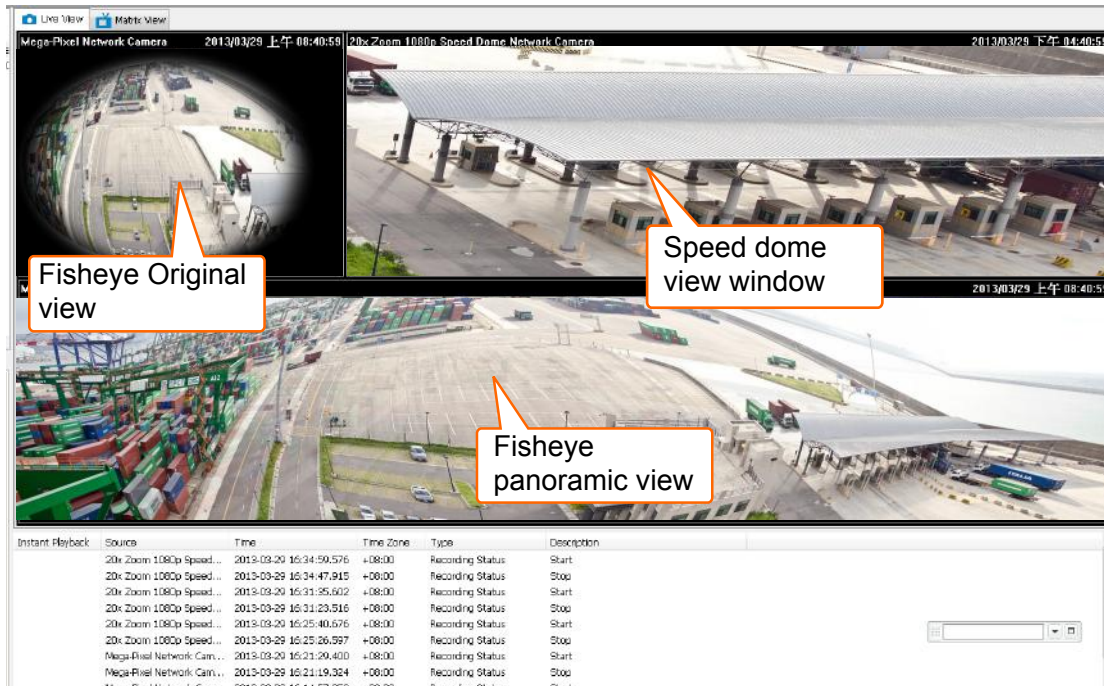

The 1P+2, 1P+6, and 1P+8 layouts apply exclusively to the Panoramic PTZ configurations. Please refer to page 274, **Appendix B Panoramic PTZ Configuration**, for details.

Normally, a Panoramic PTZ layout will consist of 1 fisheye Original view, 1 speed dome field of view, and 1 fisheye Panoramic view as shown below. Note that the interactive click-on-image control only takes place on the Original and the Panoramic views.

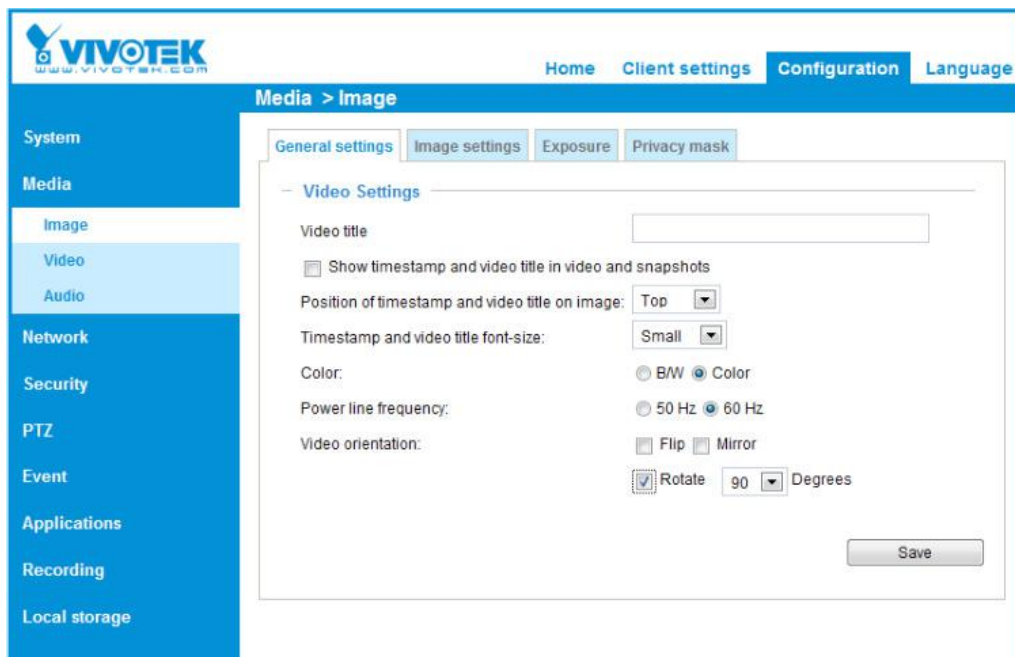

Some layout modes (1x1, 2V, 3V, 2x2, 4V, 2V+3, 1+5, 3x3, 1+12, 4x4) will spread all video channels into several pages. Some cameras support the video Rotation function for scenarios such as a tall, long corridor or the inside of a vehicle. The Rotation configuration is made through a web console with such cameras.





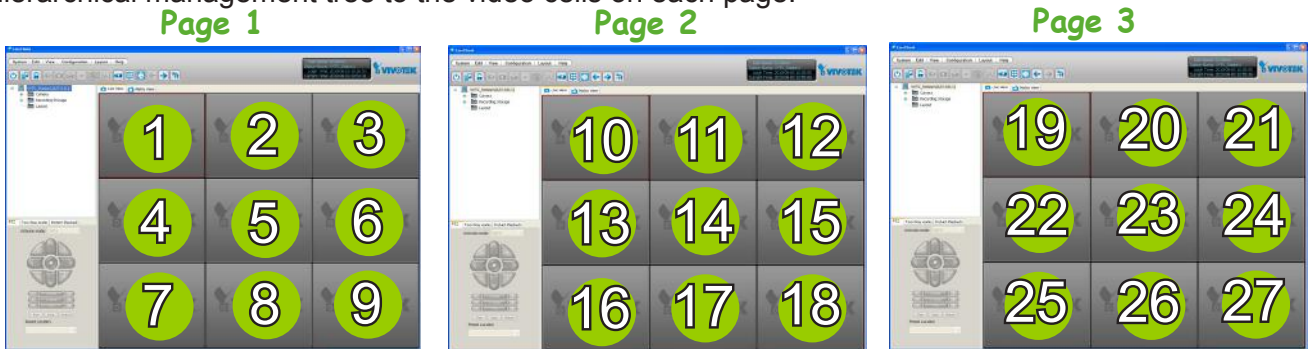

For example, under the 3x3 layout mode, you can switch among the pages by clicking  and  on the quick access bar. To arrange the content of each page, manually **drag-and-drop** cameras from the hierarchical management tree to the video cells on each page.



### Rotating Video Pages



For layout modes that contain more than one page, the LiveClient provides the rotating function for displaying all video pages in turn.

- To enable this function, click  on the Quick Access Bar, which will become  **Stop Rotating**, and the video pages will start to rotate so that the user does not have to click  to move to the next page.
- To disable this function, click  **Stop Rotating**, which will become  on the Quick Access Bar.

You can also click **Layout > Start to Rotate/Stop Rotating** to enable/disable this function.



The default rotating time interval is 6 seconds. If you want to edit rotation settings, please refer to **Rotation Settings** on page 190.

### Edit Layout

Please follow the steps below to save a layout:

- Arrange a layout mode and drag devices to their desired video cells.
- Click **Layout > Edit > Save to > New** on the menu bar. A **Layout Name** dialog box will pop up.



- Enter a name for the the layout, then click **OK** to enable the setting.

- d. Back to the monitoring window, the new layout will be displayed under the hierarchical management tree as shown below. You can save up to 10 layouts.
- e. To change to another layout, **double-click** the layout options on the hierarchical management tree, or click **Layout > Choose** on the menu bar to select a desired layout.

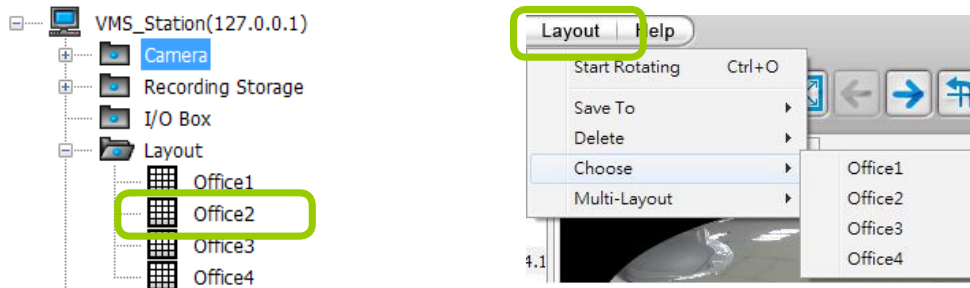

- If you want to edit an existing layout, arrange a layout mode and drag devices to the desired video cells, then click **Layout > Edit > Save to > New** to save as a new layout or an **existing layout** to replace with the new one.

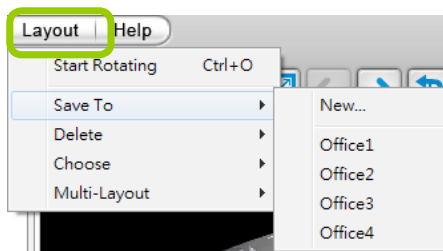

- If you want to delete an existing layout, **right-click** the layout item on the hierarchical management tree or click **Layout > Edit > Delete** on the menu bar to delete it.

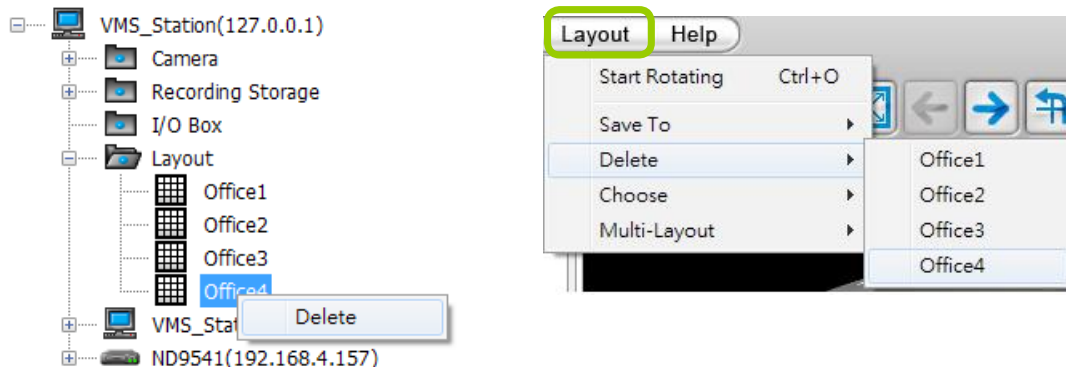

*Whenever you close the LiveClient or Playback programs and changes in screen layout have been made, you will be prompted to save your current configuration.*

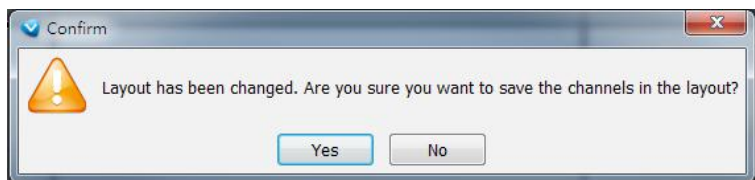

## Scheduled Layout Rotation

In a configuration consisting of a large number of cameras, you can configure different layouts containing view cells of different characteristics, e.g., a V view for a vertical, corridor scene, or a P view for panoramic glimpse of the scene. With these layouts, you can configure an automated layout rotation. Each layout will be displayed in turn, for a configurable dwell time.

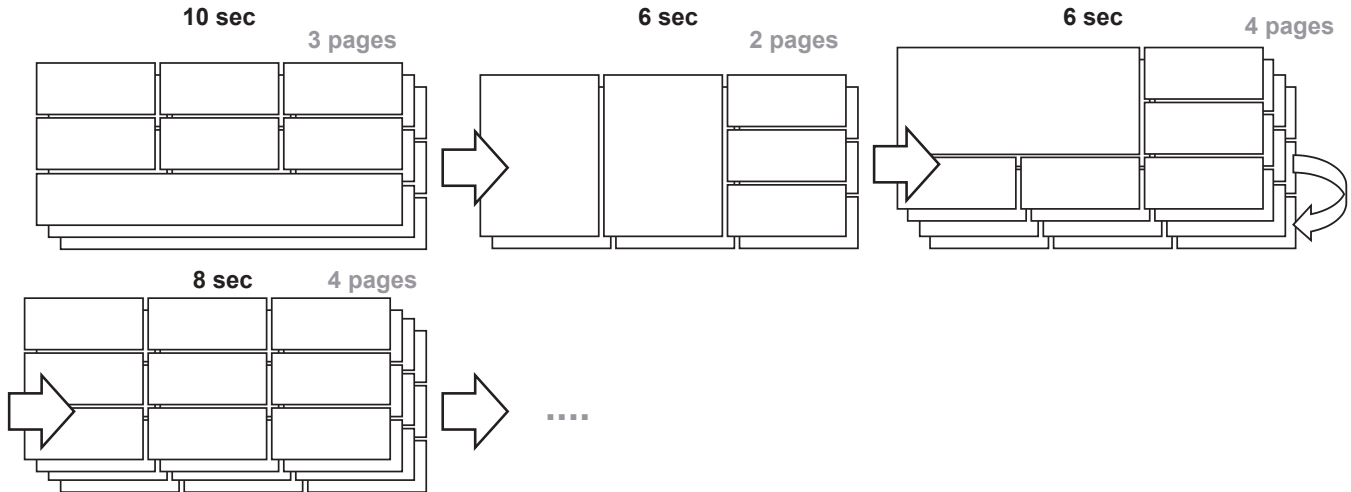

A time frame can be configured for each layout rotation. For example, one rotation may take place during the office hours, while another will take place during the off-office hours. Configuring a time frame for the layout rotation is optional. If not preferred, you can select the "Always" time frame template.

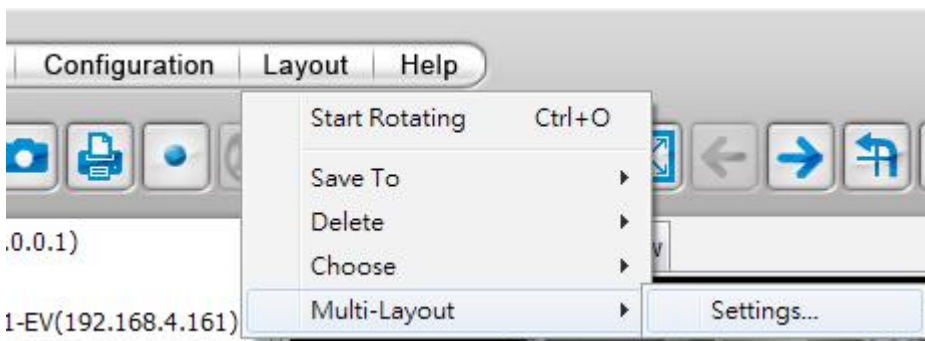

To configure a Scheduled Layout Rotation,

1. The precondition is that you should have multiple layouts created for your application needs.
2. Click on **Layout > Multi-layout > Settings**.

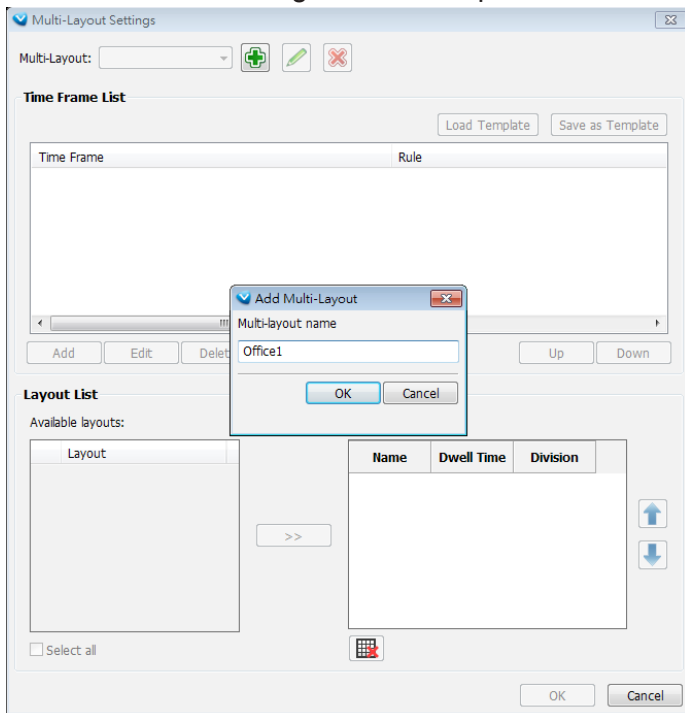

- Click on the **Add**  button to create a new scheduled layout rotation. Enter a name for the layout rotation. Avoid using these non-alphanumeric characters: (<>&"'). -.



Click on the **Edit**  button to change the name of the configuration. Click on the **Delete**  button to remove an existing configuration.

The max. number of multi-layout configurations is 128. Up to 256 individual layouts can pair with a time frame.

Note that you can not edit a multi-layout configuration while it is performing a rotation.

- Click on the **Add** button on the Time Frame pane to create a time frame. You can manually enter the Start and End time, or drag the time frame for the span of time you prefer. When done, click on the **Add** button to create the time frame.

You can use the **Load Template** button to select a pre-configured template, such as the Officehour, OffOfficehourinWorkday, Weekend, or Workday template. Make adjustments to the span of time. You can save your current time frame as a template for later use.

If necessary, select the days within a week, or the effective range for the time frame.

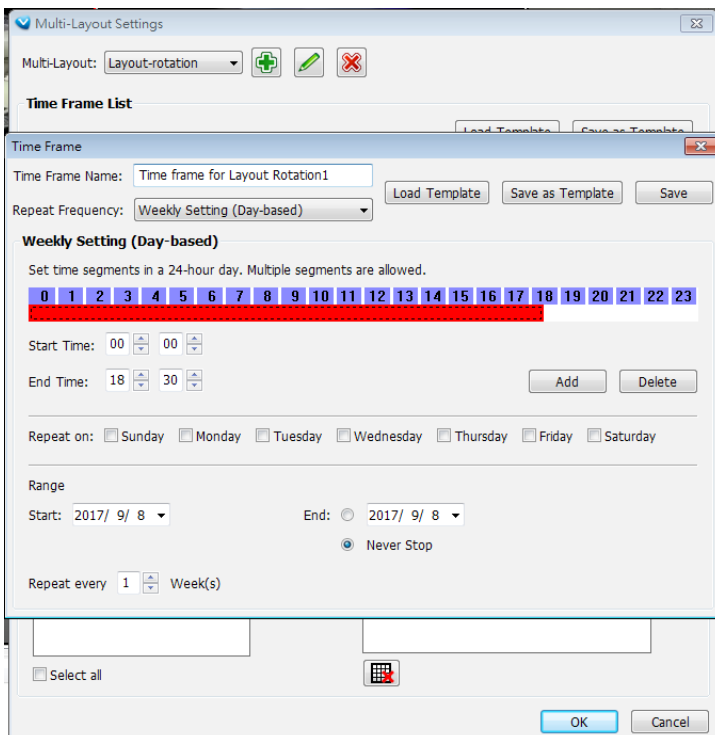



Click **Save** to complete the time frame configuration.

5. Select the layouts that will be included in the Layout Rotation.

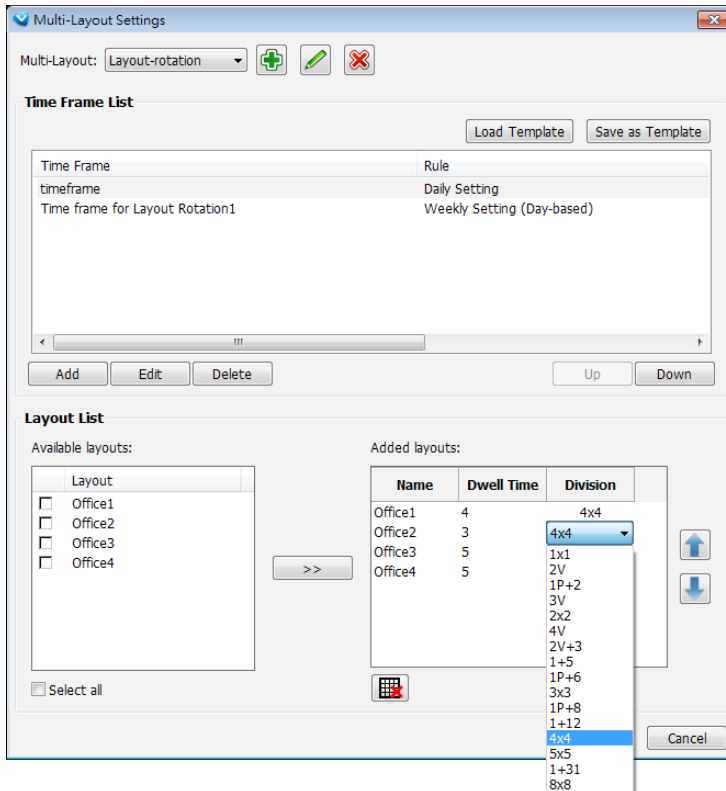
When done, click on the **Dwell Time** and **Division** field to edit their appearance and behavior on the live view.



If necessary, use the Delete  button to remove a layout. Use the move   buttons to change the display sequence of configured layouts.

6. You can start a Scheduled Rotation in many ways. Once configured, a Layout Rotation icon will appear on the device list. You can double-click on it to start the rotation.

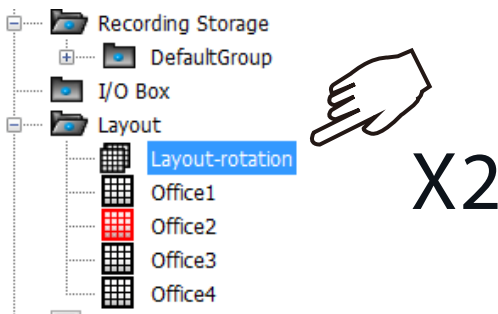

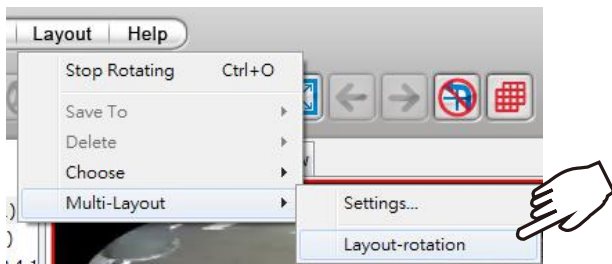

You can start a Rotation from Layout > Multi-Layout > Layout-rotation.



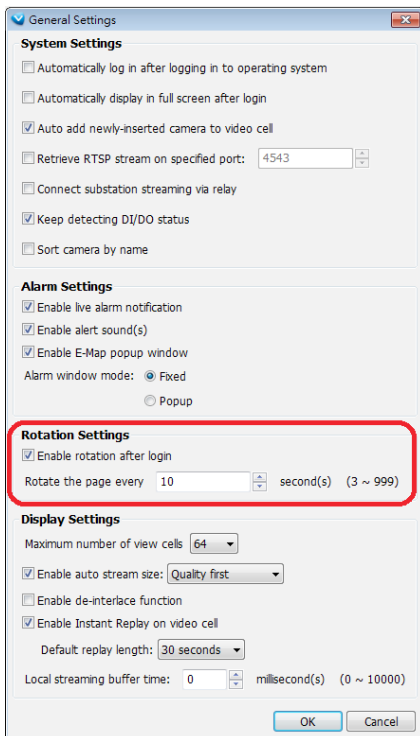

A rotation automatically starts with pre-configured layouts if you configure the option in **Configuration > Client Settings > General Settings**.



To stop a rotation, click on the Stop button  on the tool bar. This button turns red when a rotation is taking place.

You can also double-click on an existing layout to stop the rotation.

## Maximize/Minimize the Live Video Monitoring Window

- Single View: to maximize a video cell to the entire live video window

**Double-click** the video cell, or **right-click** the video cell and select **Single View**. The focused video will occupy the entire playback window as shown below.

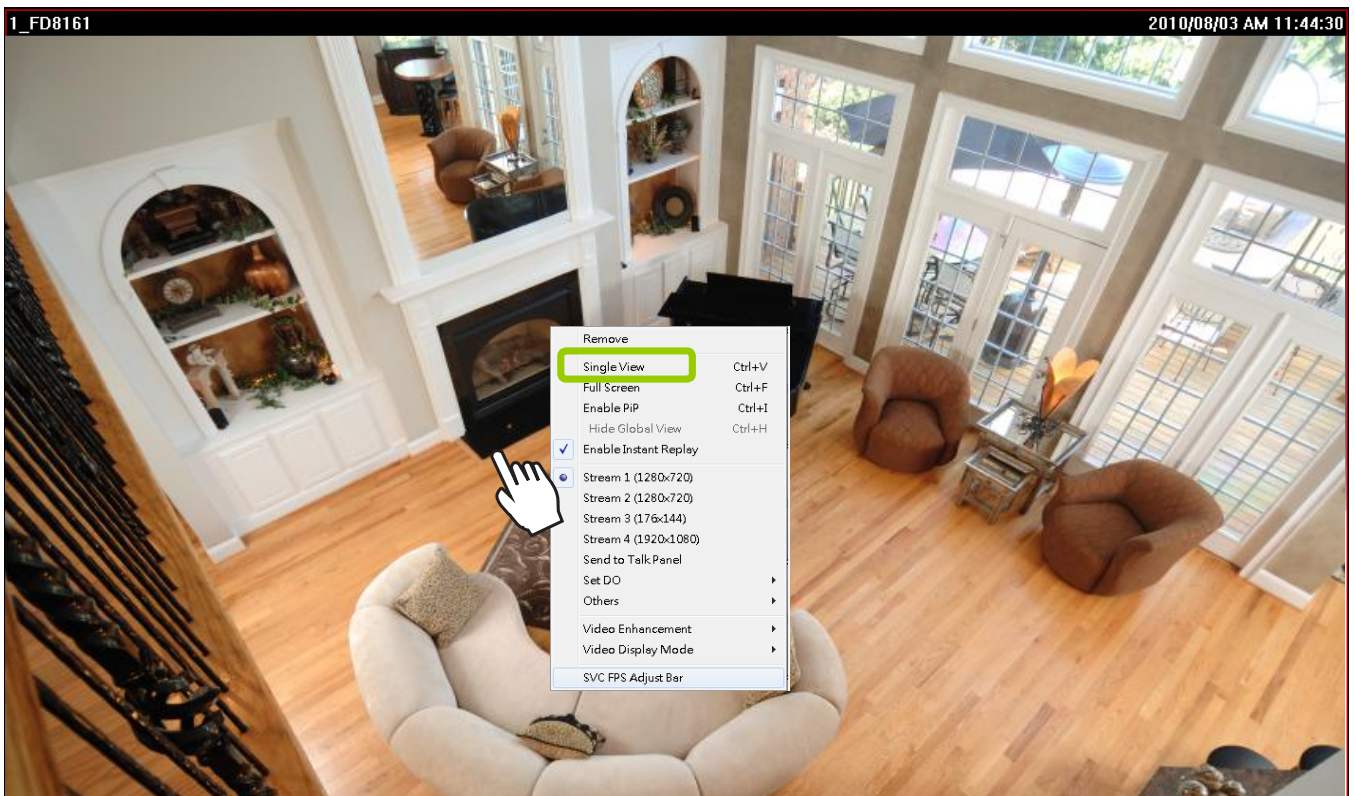
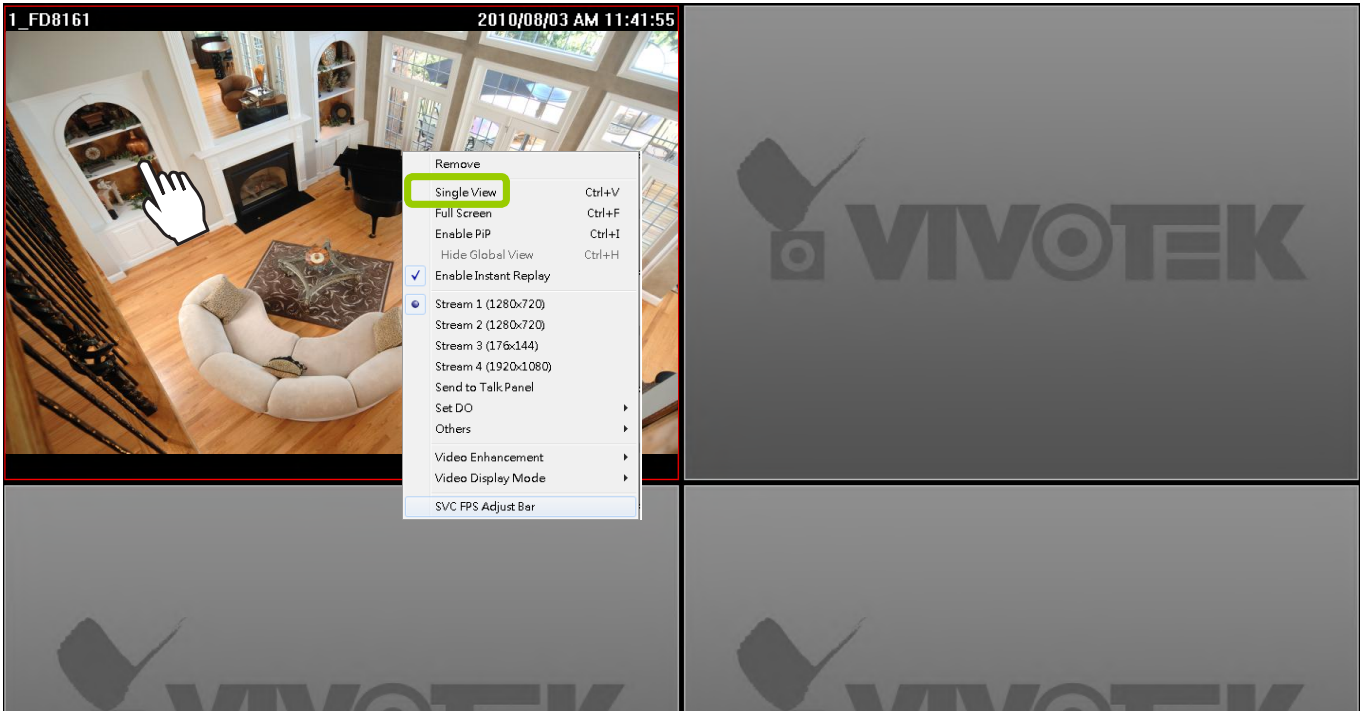

To restore to the original layout, **double-click** the video cell or **right-click** the video cell and uncheck **Single View**.

- Full Screen: Maximize the live video monitoring window to the entire screen

Click **Full Screen**  on the quick access bar or **right-click** the video cell and select **Full Screen**. In addition, you can also click **View > Full Screen** on the menu bar to maximize the live video monitoring window.

To restore to the original layout, you can **right-click** a video cell and uncheck **Full Screen** or click the **Esc** button on the keyboard to exit full screen mode.

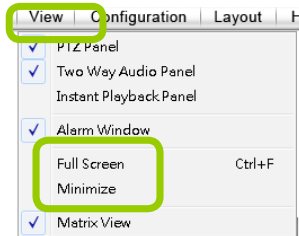

- Minimize: If you click **View > Minimize** on the menu bar, LiveClient will minimize to the Windows tool bar.

## View Live Video on Dual Monitors

VAST also supports live video viewing on dual monitors, allowing you to manage a maximum of 64 channels concurrently on two screens. Moreover, the layout of the video monitoring window on different monitors can be set up individually.

Please follow the steps below to set up dual-screen mode:

- Set up dual monitors for your local computer.
- Launch VAST LiveClient on monitor 1.
- Click **System > Second View** on monitor 1, then the live video monitoring window will be displayed in monitor 2 as shown below.

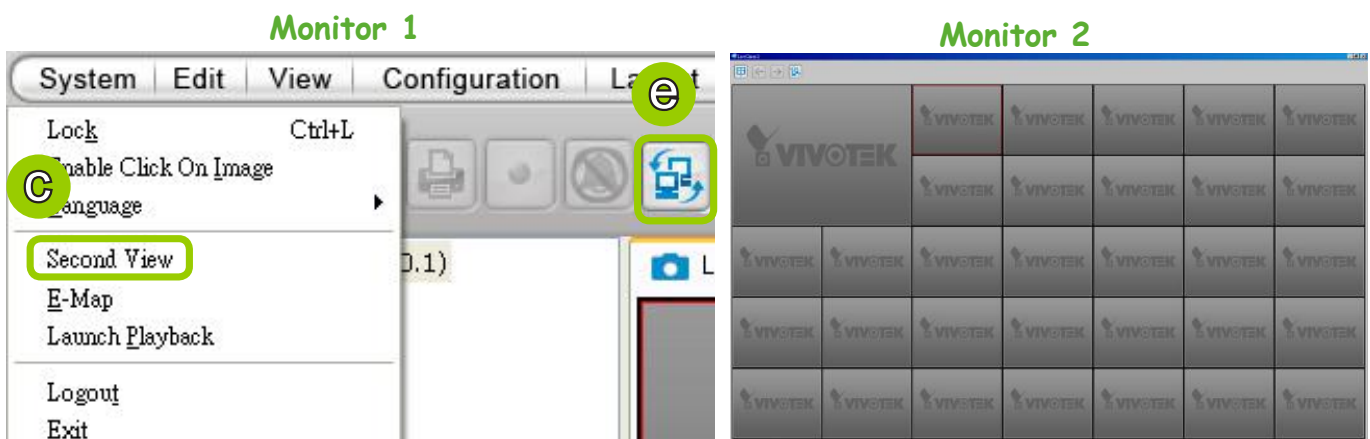

- There are two ways to view live videos. One is to **drag-and-drop** the target device from the hierarchical management tree window to the video cells. The other is to click any video cell on monitor 1 or monitor 2, then **double-click** the target device; the live video will be displayed in monitor 1 or 2 in accordance with your selection.
- If you click **Switch Screen**  on the quick access bar, the live monitoring window on monitor 1 and monitor 2 will swap.

## Simultaneously Viewing up to 128 Channels

If you select 1+31 layout on dual screens, you can view a maximum of 128 channels live video simultaneously. In this case, each layout contains 32 channels on 1 video page.

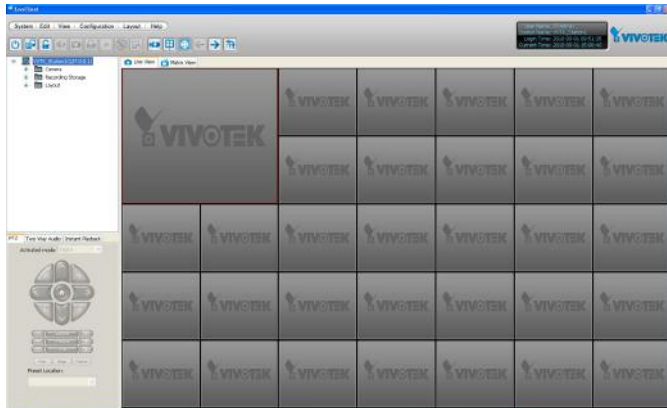

Monitor 1 - 32 channel

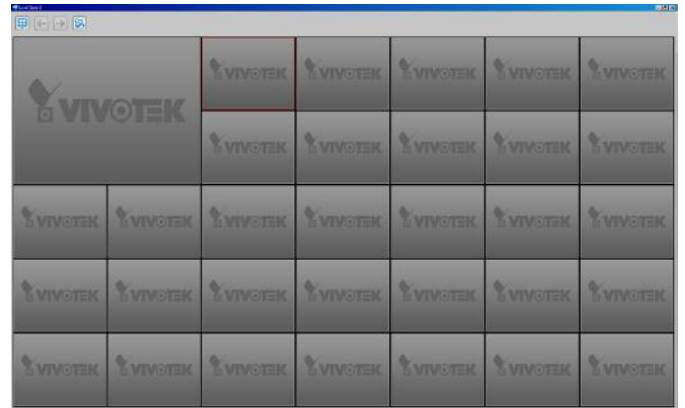

Monitor 2 - 32 channel



## Using different layouts on each monitor

You can also select different layout for two monitors, simply click the **Layout** button  on the quick access bar. Below is an example of the 2x2 layout with 8 video pages on monitor 1 and the 4x4 layout with 2 video pages on monitor 2. You can click  and  to switch among the video pages.

Monitor 1 - page 1

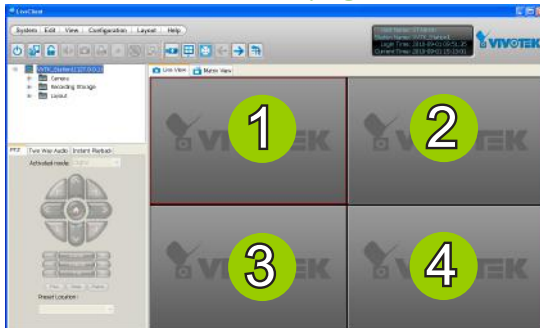

Monitor 2 - page 1



Monitor 1 - page 2

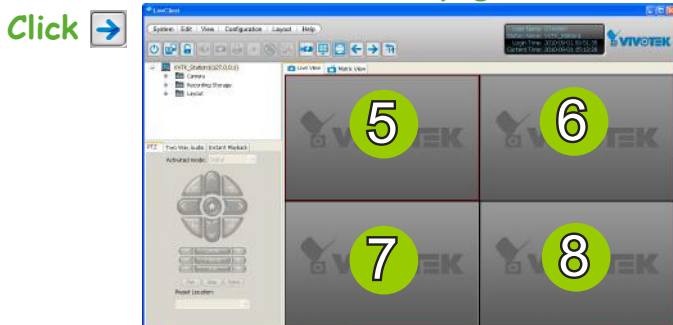

Monitor 2 - page 2



⋮

Monitor 1 - page 8

## View Live Video with Multiple Monitors

If you have multiple screens in your monitoring center, you can switch the VAST LiveClient Window among these screens.

- If you have two monitors, click **Switch Screen**  on the menu bar; the LiveClient window on monitor 1 will switch to monitor 2.

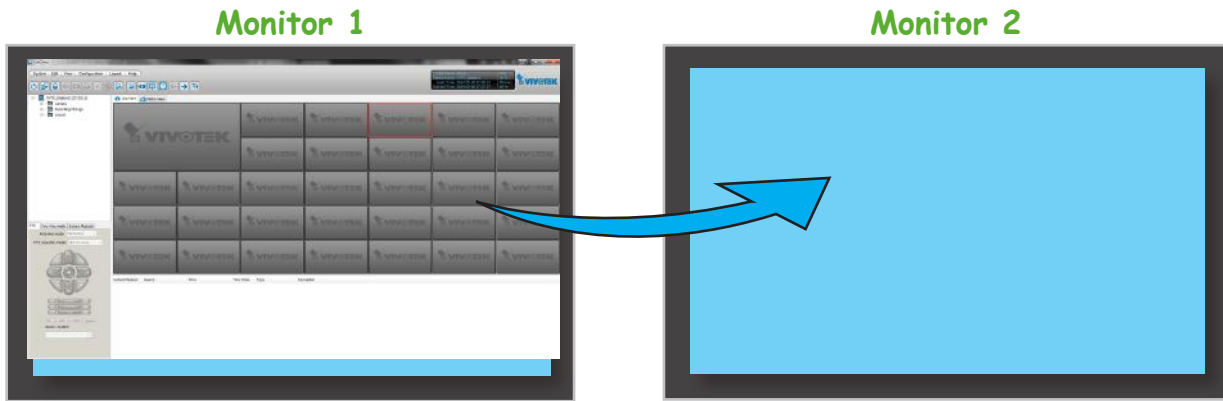

- If you have two monitors, a drop-down list will be displayed when you click **Switch Screen**  on the menu bar. The number of items on this list depends on the number of your screens. Select a desired screen on the drop-down list and the LiveClient Window will switch to the specified screen.



## How to Manage Stations

The VAST Server allows you to construct a hierarchical management system by adding more sub-stations to the root station. Under each sub-station, it can also insert sub-stations and network cameras.

### Relay Settings

Before adding a sub-station, please follow the instruction below to enable the sub-station's Relay Settings first.

- Login to the sub-station.
- Select the station from the hierarchical management tree.
- Click **Configuration > Station Settings > Relay Settings** on the menu bar (or **right-click** the station on the hierarchical management tree and select **Station Settings > Relay Settings**).

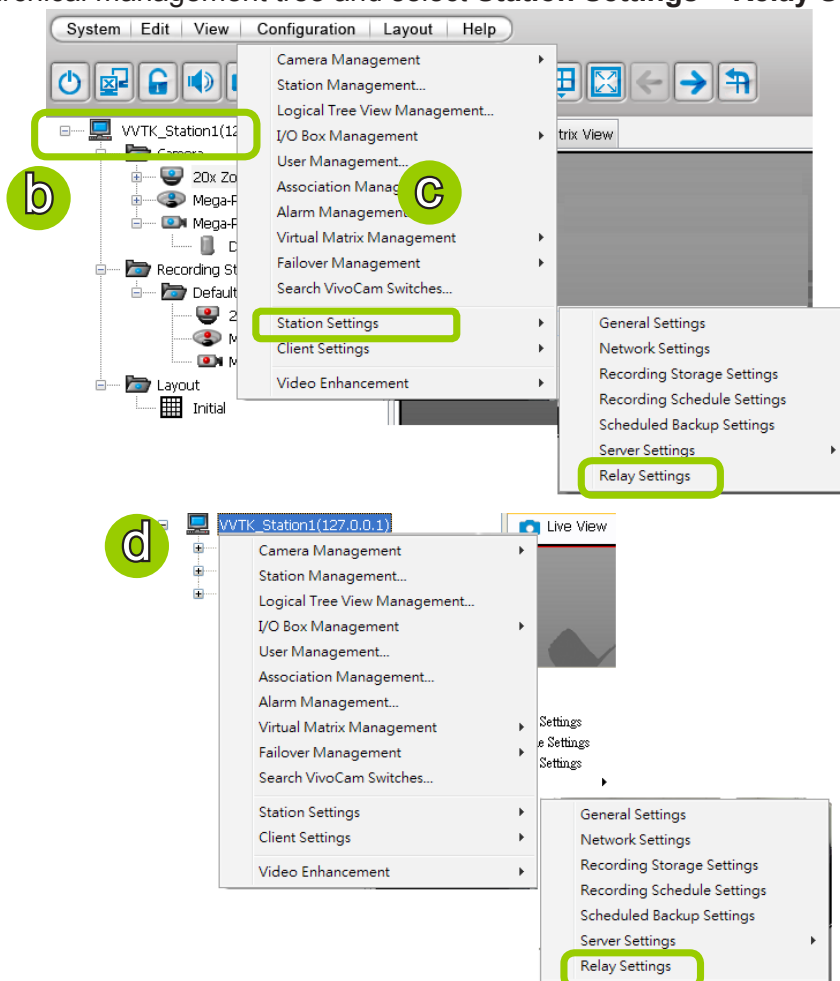

- The **Relay Settings** window will pop up. Check **Allow Relay Connection** and enter a **Password**. Then click **OK** to enable the settings.

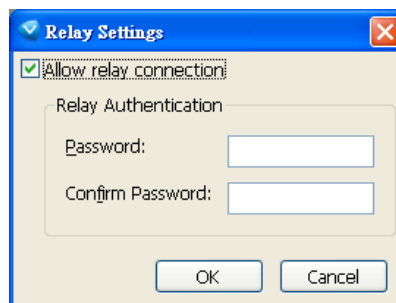

## Insert Sub-stations

Please follow the steps below to add sub-stations:

- a. Select a target station from the hierarchical management tree.
- b. Click **Configuration > Station Management** on the menu bar (or **right-click** the target station, then select **Station Management**).
- c. The **Station Management** window will pop up. The hierarchical management tree managed by the target station will be displayed on the left panel.

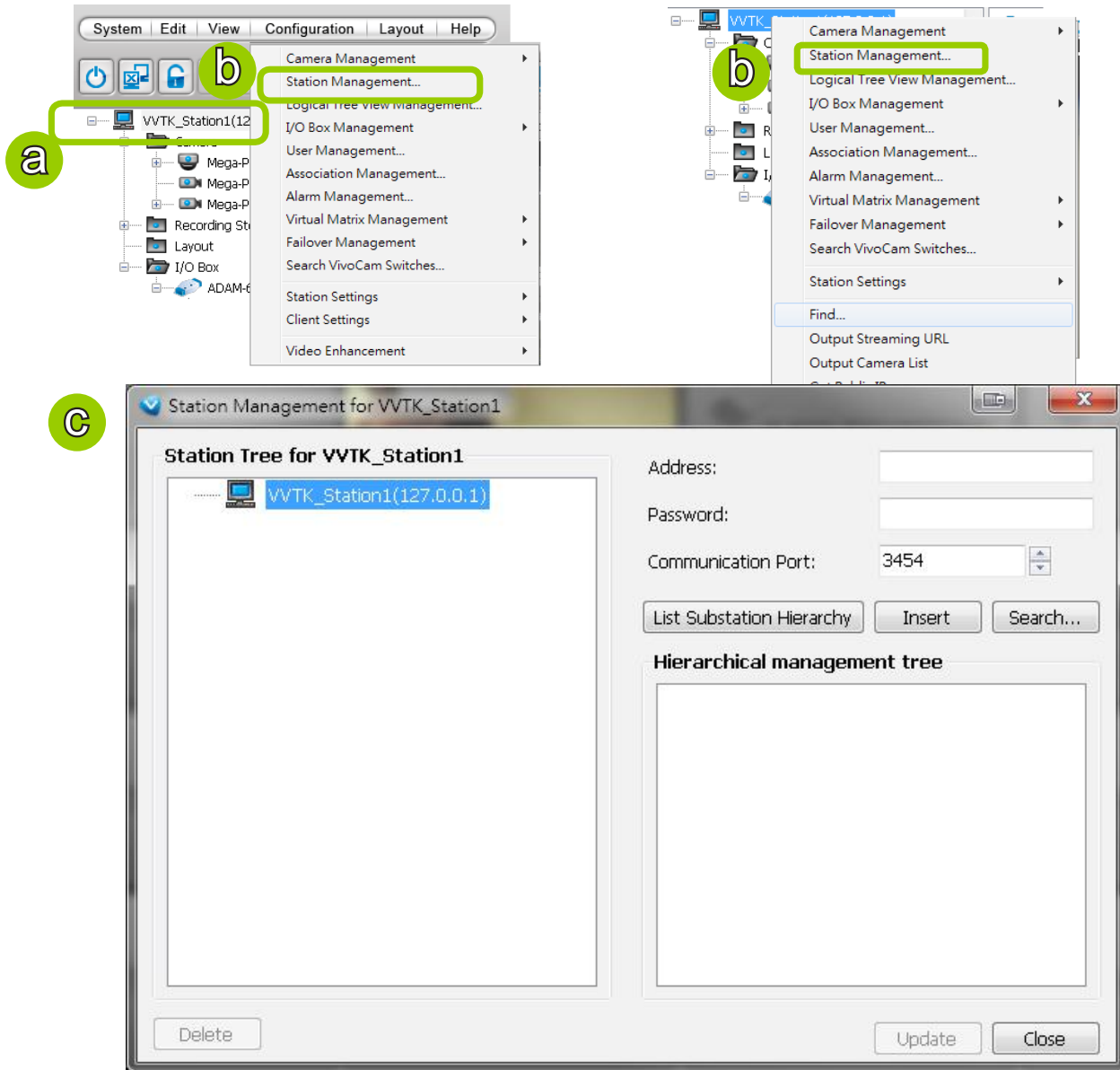

- d. Before inserting the sub-station, you can click **List Sub-station Hierarchy** button to know if there is any sub-station under it.
- e. Enter the sub-station's **IP address** and **Password (defined in Relay Settings, not login password)**. The default communication port is 3454.
  - If the sub-station is on the LAN, you can click the **Search Station** button to detect all ST7501 and VAST on the LAN. A **Station List** window will pop up and show a list of detected cameras on the LAN. On the top of **Camera List** window, you can select "**List the stations which are not inserted**" or "**List all stations**". The items listed below will then change accordingly. You can click **Name, IP Address, Model, Http port** to sort the items. Then select a device from the list to insert to the station.

- f. When all settings are done, click **Insert** to add the sub-station to the target station. The sub-station will be displayed under the left station tree.
- g. To insert additional sub-stations to the target station, repeat the above steps.
- h. When completed, click **Close** to exit the Station Management window.

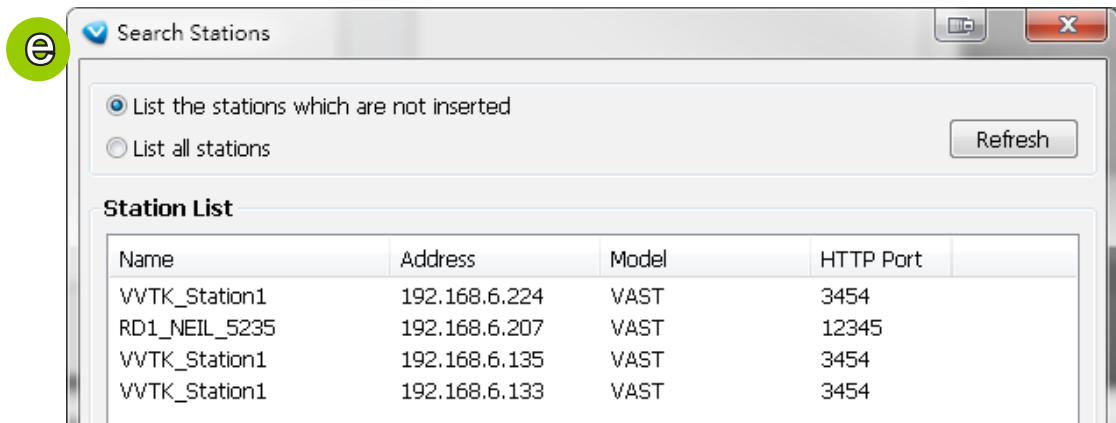
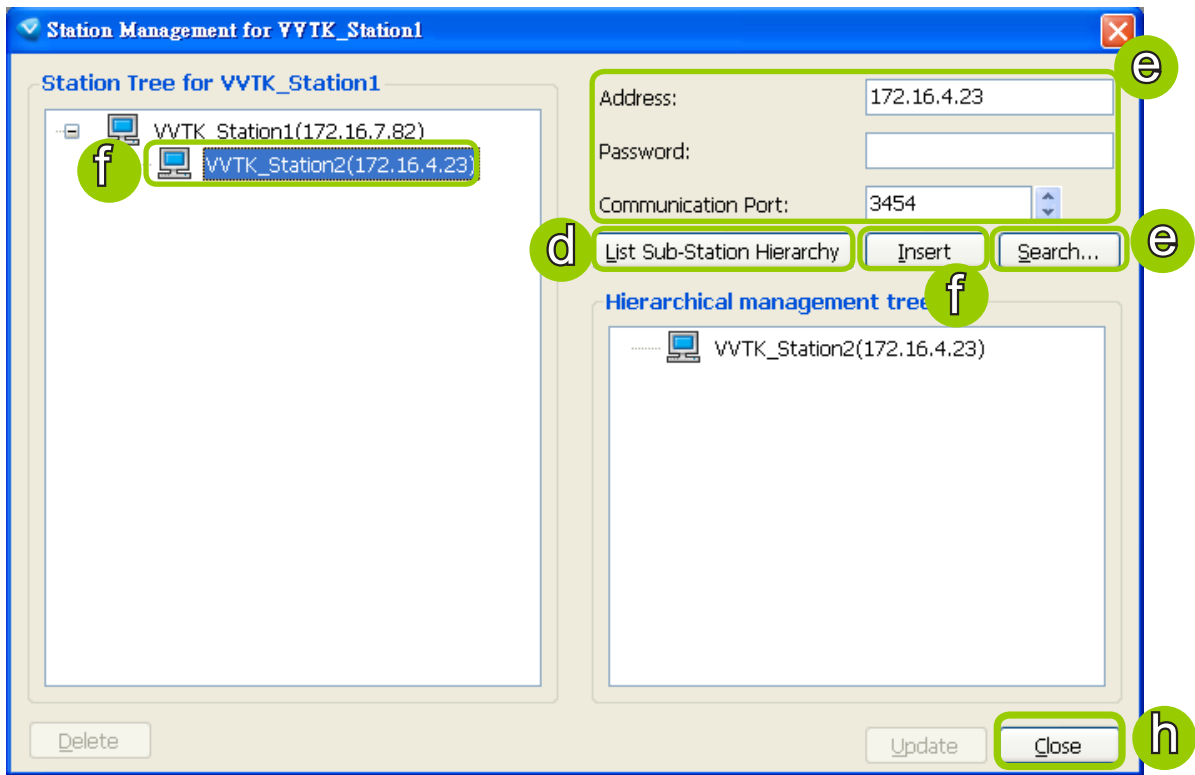

- i. Back to the main window, you will find the newly-inserted stations displayed under the hierarchical management tree.

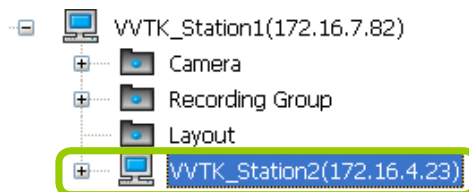





- You can add VAST or free standard ST7501 as the sub-stations. The number of sub-stations can be added to the server depends on your key dongle. The VAST server will automatically detect the USB dongle installed on your host PC. Following is an illustration for two-level hierarchical architecture:

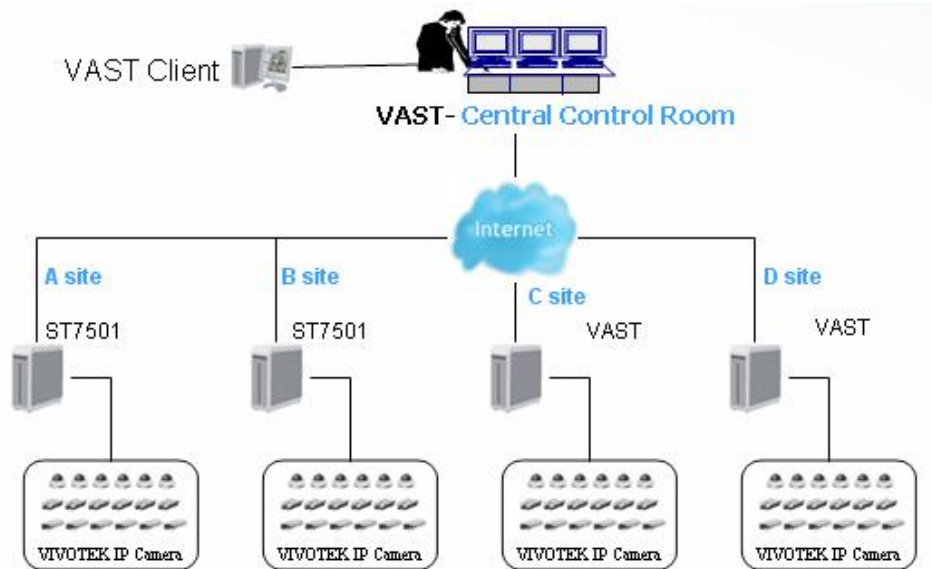

- Please note that the following cyclic relay is not allowed.

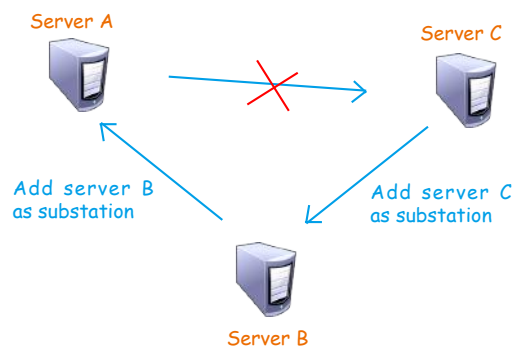

## Delete Sub-stations

There are two ways to delete a sub-station:

Method 1. Select the sub-station on the hierarchical management tree, then **right-click** to delete.

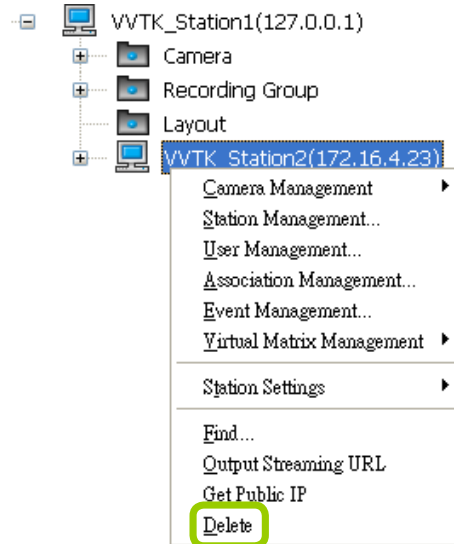

Method 2. Delete the sub-station via the Station Management window:

- Click the station on the hierarchical management tree, then click **Configuration > Station Management** on the menu bar (or **right-click** the station, then select **Station Management**).
- The **Station Management** window will pop up. The hierarchical management tree managed by the station will be displayed in the left Station List window.
- Select a station from the list you want to delete. Its related information will automatically be displayed in the corresponding blanks in the Station Management window.
- Click **Delete** to delete it.
- To delete additional devices, repeat step c. and d.
- When completed, click **Close** to exit the camera management window and return to the main window. The deleted device will disappear from the hierarchical management tree.

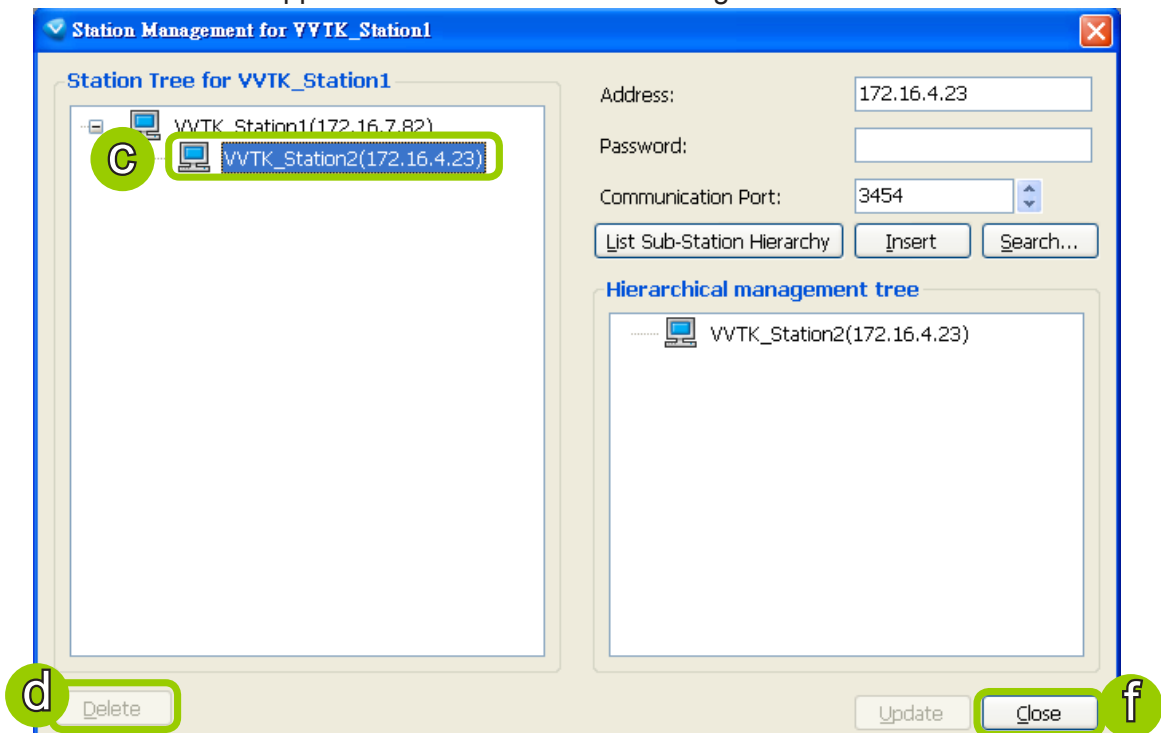

## Update Stations

Please follow the steps below to update a station via Station Management window:

- Right-click** the target device on the hierarchical management tree and click **Station Management**.
- The **Station Management** window will pop up. The hierarchical management tree managed by the station will be displayed in the Station List window on the left.
- Select a station from the list you want to delete. Its related information will automatically be displayed in the corresponding blanks in the Station Management window.
- When all settings are completed, click **Update** to enable the settings.

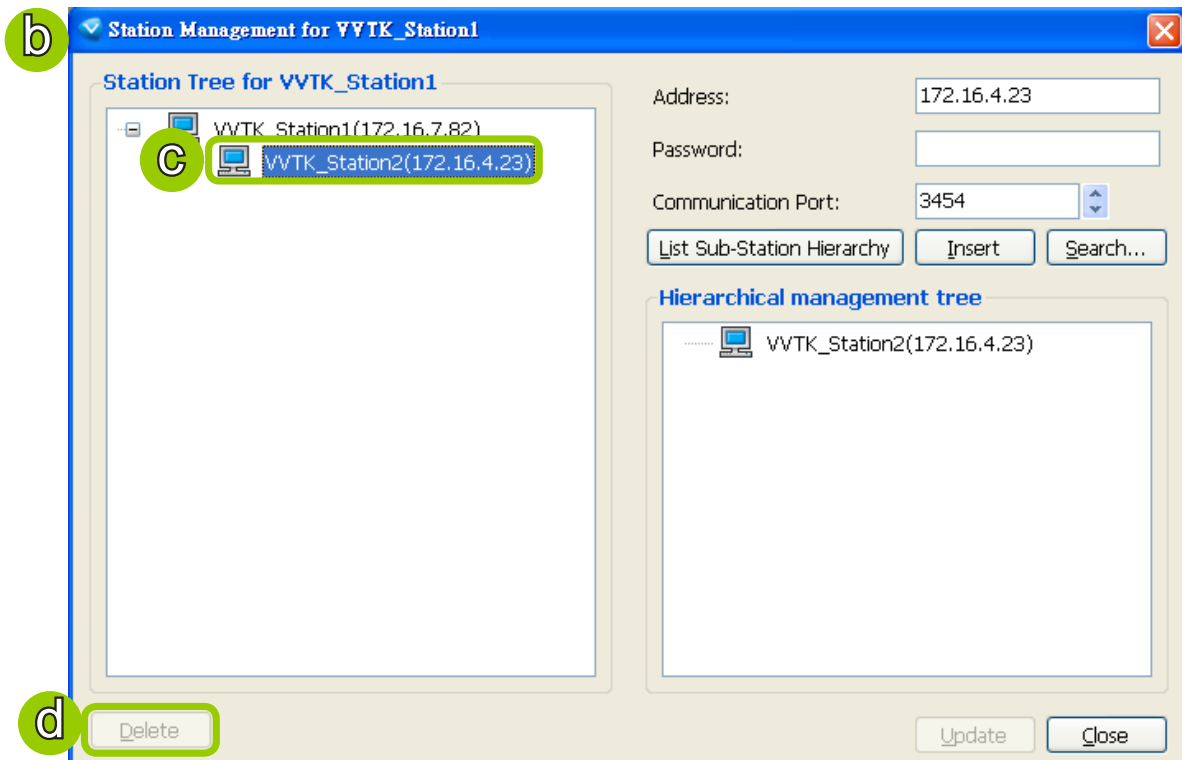
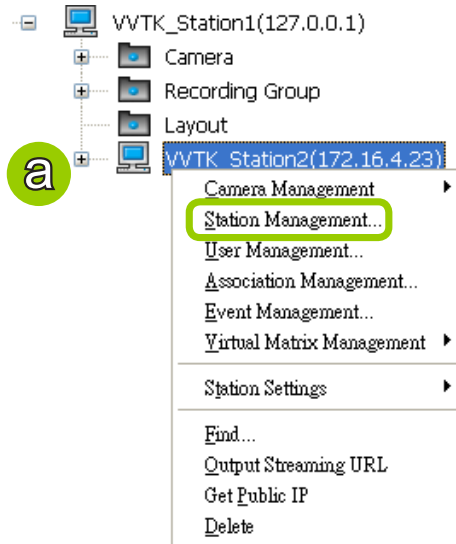

## How to Manage User Accounts

VAST allows users to apply multiple user accounts to a station with five levels of user roles: Administrator > Power User > User > Operator > Guest. Each role has different permissions listed as shown below. Moreover, Administrators have the highest privileges, while Power Users can only add/edit users as Power Users, Users, Operators, and Guests.

### The Default User Roles and Permissions of User Accounts

Functions \ User Roles	Administrator	Power User	User	Operator	Guest	Description
Station Management	✓	✓				Add sub-station under the existing station
User Management	✓	✓	✓			Manage user accounts
Camera Management	✓	✓				Insert and configure the camera settings
Association Management	✓	✓	✓			Access and modify the association settings
Access Alarm Management	✓	✓	✓			Access Alarm management
Modify Alarm Management	✓	✓	✓			Modify Alarm management
General Station Settings	✓	✓				Modify general station settings
Station Network Settings	✓	✓				Modify network settings
Access Recording Storage/ Recording Schedule Settings	✓	✓	✓	✓		Access the recording group and recording schedule
Modify Recording Storage/ Recording Schedule Settings	✓	✓	✓			Configure the recording group and recording schedule
Manually Record	✓	✓	✓	✓		Enable the recording function manually
Scheduled Backup Settings	✓	✓	✓			Configure backup schedule
Access Server Settings	✓	✓	✓			Access server settings
Modify Server Settings	✓	✓	✓			Modify server settings
License Management	✓	✓				Allow user to manage station licenses
Relay Management	✓	✓				Allow user to manage station relaying settings
Client Settings	✓	✓	✓	✓		Configure the client settings: snapshot, AVI, etc.
Video Enhancement Settings	✓	✓	✓			Allow user to edit profile for video enhancement and assign profile to camera in LiveClient

Privileges \ User Roles	Administrator	Power User	User	Operator	Guest	Description
<b>Modify Directories</b>	✓	✓	✓			Add, remove and rename directories
<b>Delete Station</b>	✓	✓				Delete sub-station from a (parent) station
<b>Delete Camera</b>	✓	✓				Delete camera from the station
<b>PTZ Control</b>	✓	✓	✓	✓		PTZ control for PTZ cameras and speed domes in LiveClient
<b>Device Control</b>	✓	✓	✓	✓		Control the digital output or white light/IR illuminators of the cameras
<b>Talk Control</b>	✓	✓	✓	✓		Two way audio function for the cameras
<b>Access Camera Configuration</b>	✓	✓	✓			Access the camera settings
<b>Modify E-map</b>	✓	✓	✓	✓		Allow user to modify the E-map
<b>Event Search</b>	✓	✓	✓	✓		Use built-in search engine to search specific events
<b>Log Viewer</b>	✓	✓	✓	✓		Use built-in search engine to search the log
<b>Backup</b>	✓	✓	✓	✓		Back up database manually
<b>Record/Export Media</b>	✓	✓	✓	✓		Record live stream or export playback stream to local files
<b>Virtual Matrix Management</b>	✓	✓				Allow user to manage virtual matrix
<b>Virtual Matrix Control</b>	✓	✓	✓	✓		Allow user to control virtual matrix
<b>Playback Authority</b>	✓	✓				Allow user to access Playback

## Manage a User Account

### Add a New User Account - Basic Account

- Select the station from the hierarchical management tree.
- Click **Configuration > User Management** on the menu bar (or **right-click** the station, then select **User Management**).

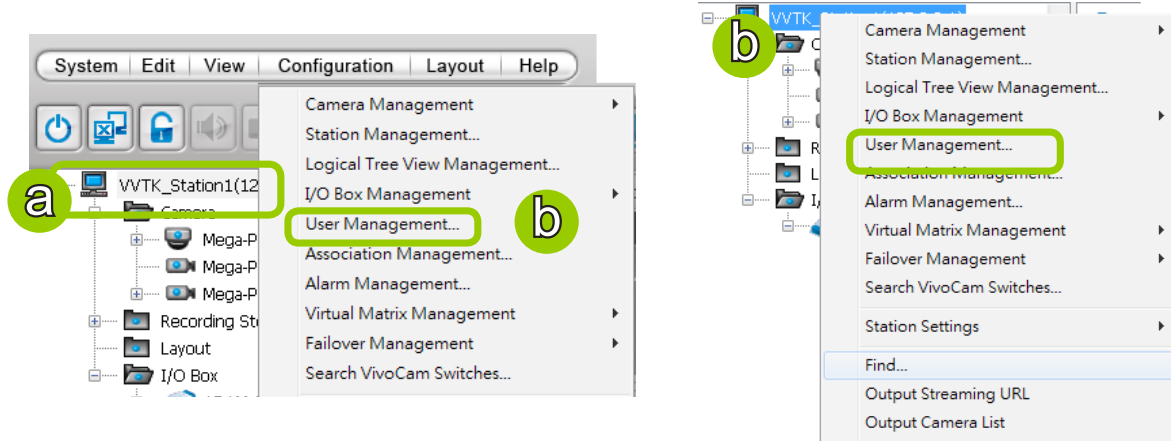

- The **User Management** window will pop up. The user accounts under the station will be displayed under the left User List tree. Up to 1,021 users can be created (not including the default Admin and two internal communication accounts).
- Enter the **User Name**, **Password**, and specify the **User Role** of this user.
- Click **Add** to add the user account to the station. It will be displayed under the User List.

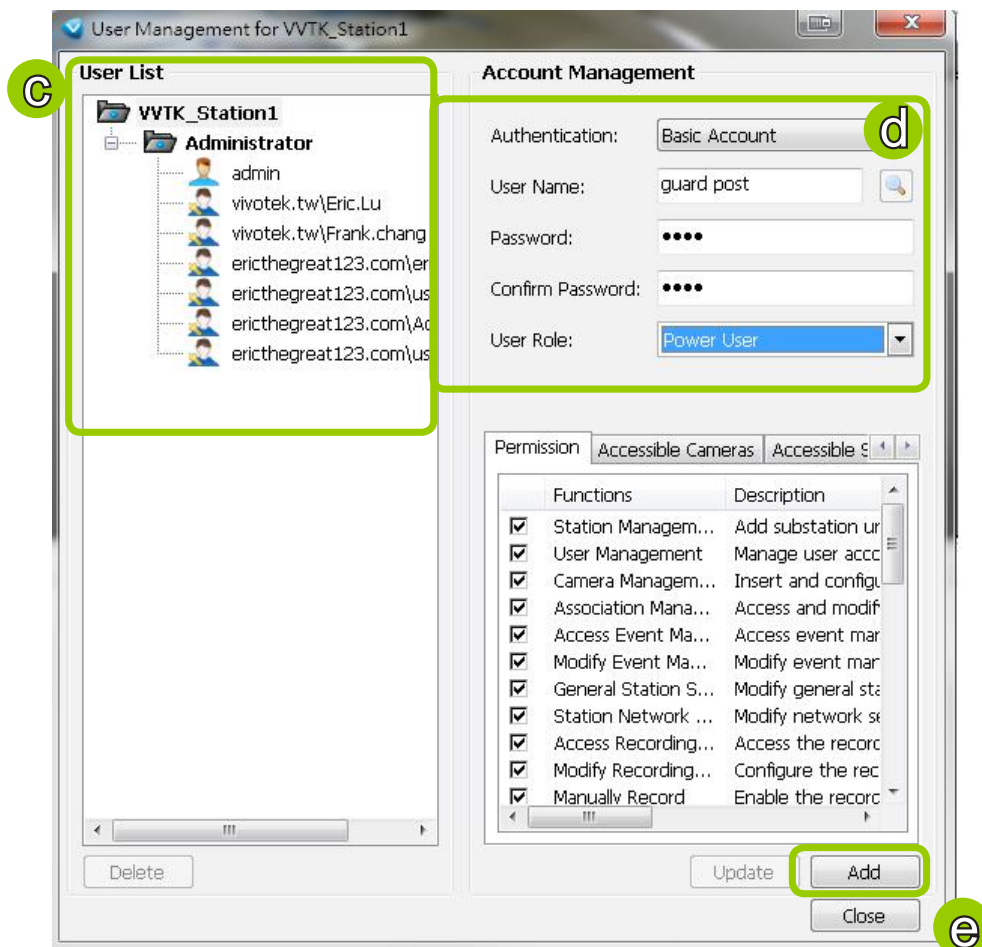

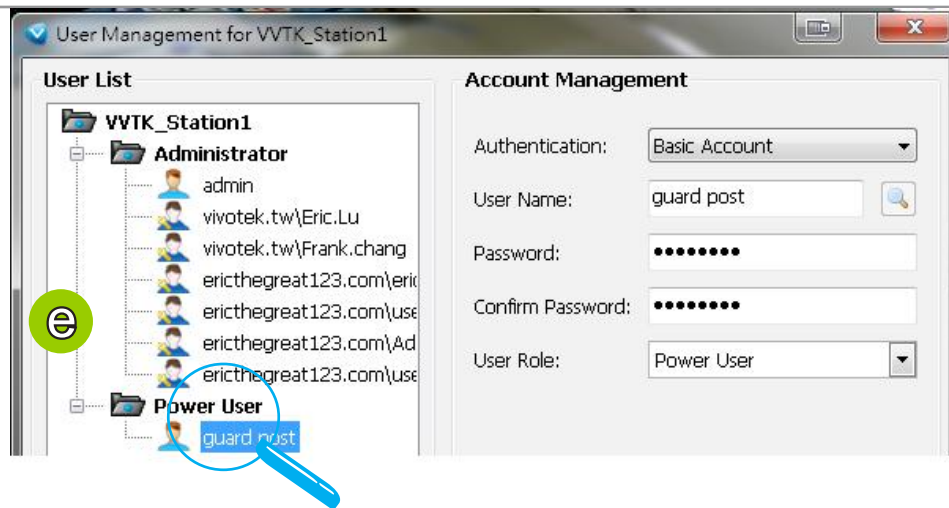

### Add a New User Account - Windows AD Account

In an established, enterprise network environment, the support for Windows AD (Active Directory) infrastructure enables ease of integration using the credentials of existing users. Using the same AD authentication methodologies, you can configure the clients or users in an established network to access the VAST server configuration.

Note the following with Windows AD support:

1. The ST7501 software does not support Windows AD accounts. However, if you log in to a VAST server which supports Windows AD accounts, the AD account will work for an ST7501 sub-station managed by VAST.
2. If you install VAST server on a Windows XP machine with Postgre SQL server, the login using a Windows AD account will not work.
3. The VAST server must reside in a domain managed by the AD server.
4. This function does not support the environment that spans across multiple AD domains.
5. A user account hosted by an AD server cannot be modified in VAST.
6. A User Group and its members configured in AD cannot be managed in VAST.
7. You cannot add an account having the same name as one you used to log in VAST.
8. There are 3 types of account for VAST: VIVOTEK account, AD single user, AD group.

a. To configure a Windows AD user as a VAST user, enter the **User Management** window. Select **Windows AD Account**, and click on the **Search** button.

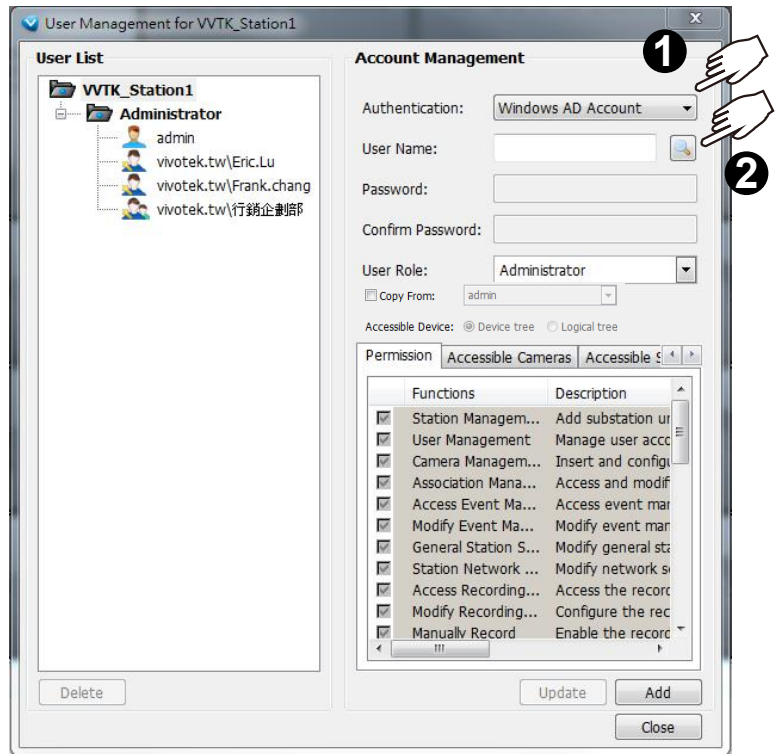

b. A Select User or Group window will prompt. Click on the **Object type** button. Select **Group** or **User**.

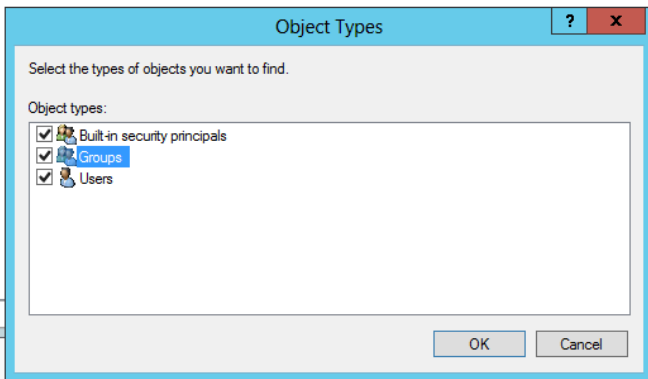
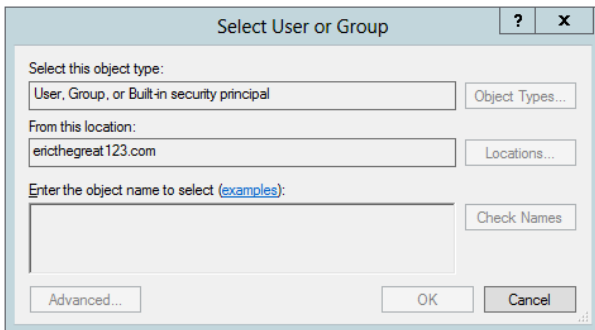

c. You can also click on the **Location** button to specify a search range on a location on the AD hierarchical tree, e.g., a department in an organization.

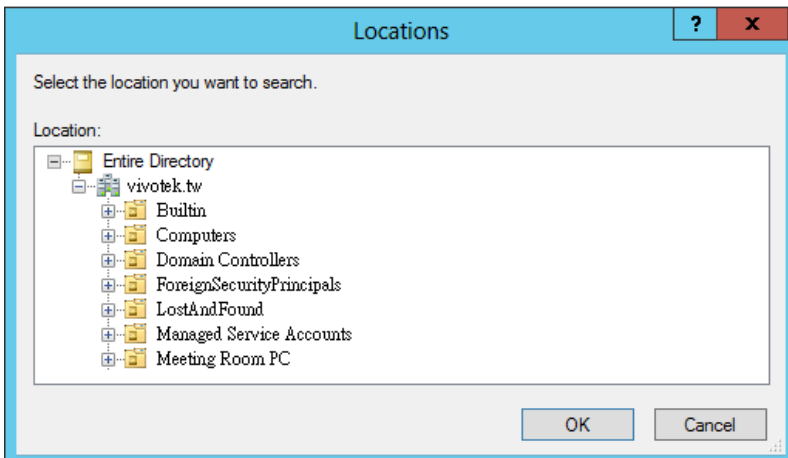



d. Enter a name for user or group that is known to the AD. Click on the **Check Name** button. The search results will be listed.

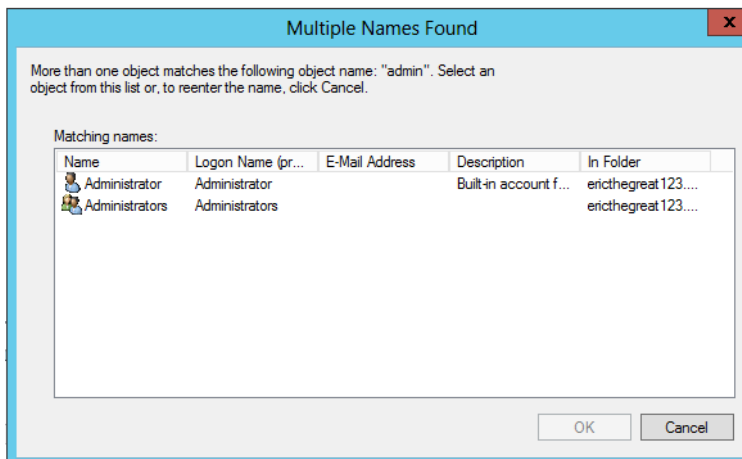
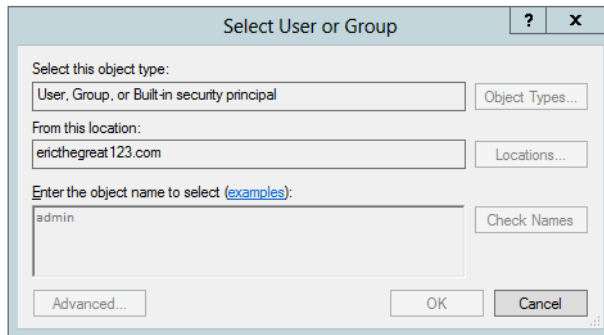

e. Click to select a user, and then click **OK** to confirm your selection.

f. Users thus added will be listed on the left in the **User List**. These users or groups will be listed with their domain name listed in front of them and indicated by different icons .

g. Select a **User Role** for the AD user as Administrator, Power user, user, operator, or guest.

h. Select user's privileges in terms of the **Permission**, **Accessible Cameras**, and **Accessible Substations** from the tabbed windows below.

i. Click the **Add** button to complete the process.

The next time you log in, you can select **Windows AD Account**, enter User Name and Password to access the VAST software.

Note that you should specify the domain name in front of the user name; "domain name\user name."

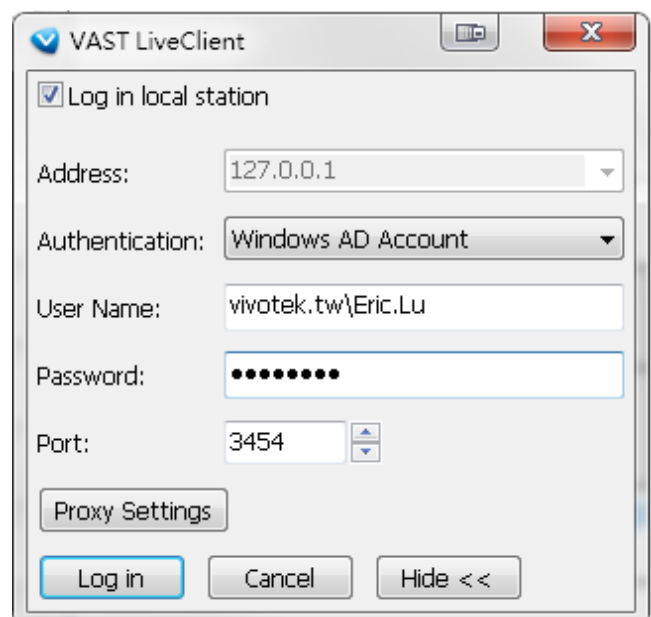

### Permission of the User Account

Administrator is granted with all access privileges, while other user roles' permission is limited. If you want to modify the permission, please login as the Administrator to configure the settings.

f. Select a User account from the User List tree.

g. If you want to set the limit of the permission of the user, click **Permission** tab to check or uncheck the items.

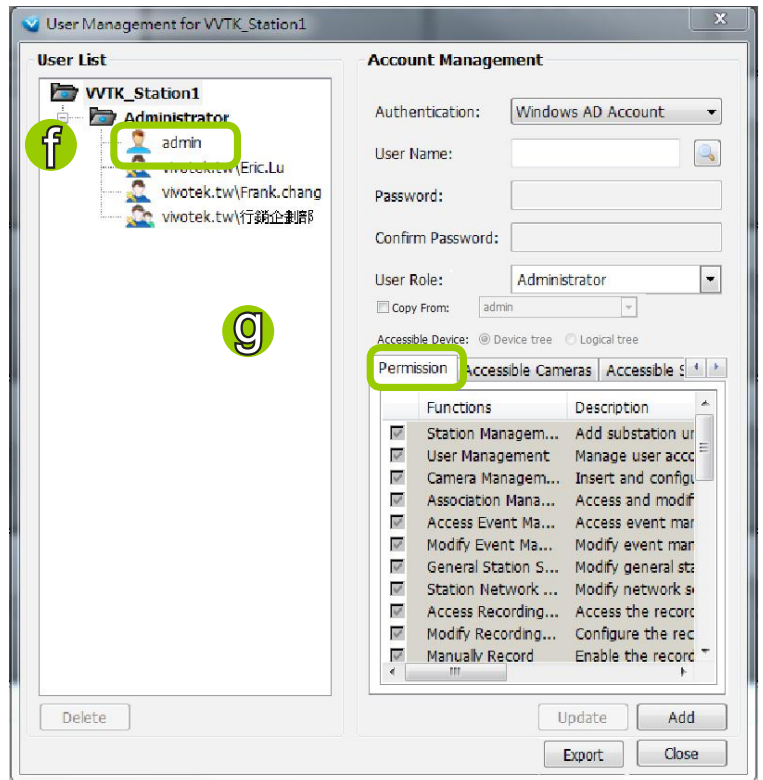

h. If you want to limit the devices accessible by the user, click **Accessible Cameras** tab to select the desired devices.

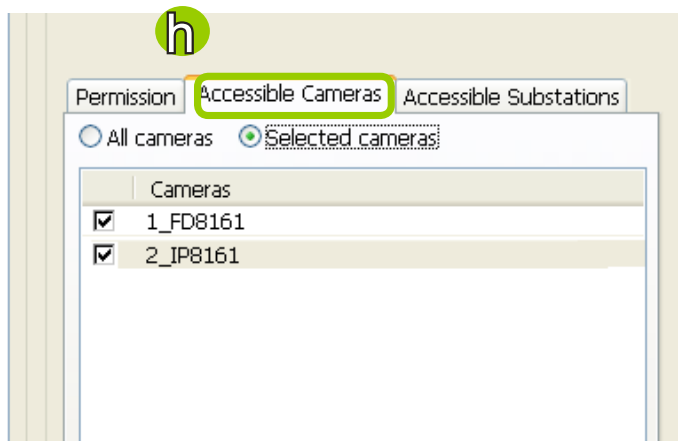

You can select either a basic user can access a device tree or a logical tree.

- i. If you want to configure the access limit of the sub-station accessible by the user, click **Accessible Substations** tab to select the desired devices.



If you want to remove access permission mentioned above from the account, the user will not able to operate some functions listed in the following warning dialog.

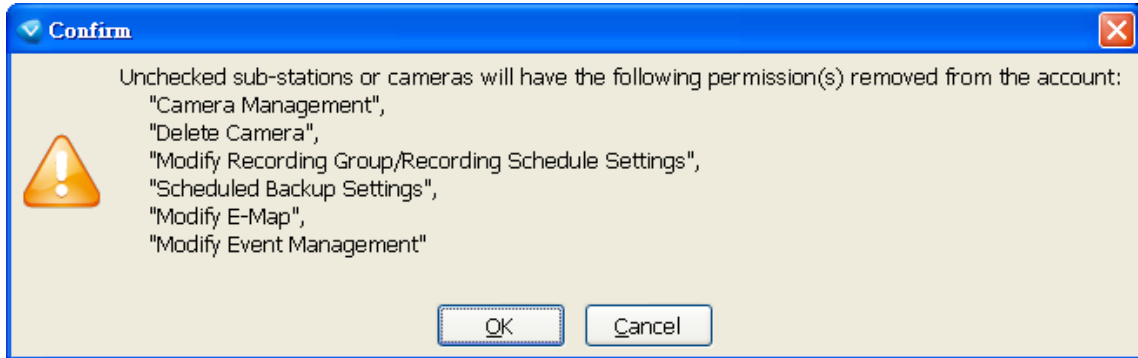

- j. When completed, click **Update** to enable the new settings.

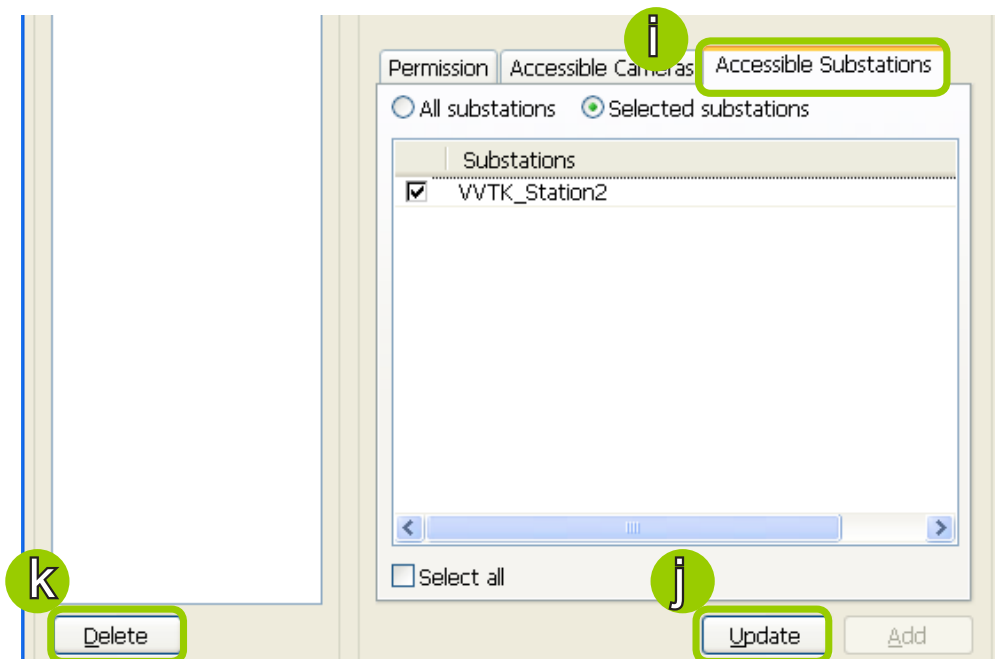

### Delete the User Account

- k. Click **Delete**, a delete user dialog will pop up. Click **OK** to delete the user account.

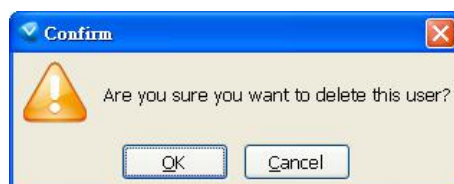

If the Administrator modifies or deletes the User Account, that modified user might be kicked off from the station.

## Expiration

Click **Expiration** to configure the extension of time allowed for a user's access. For example, an administrator may want some users to have access to the LiveClient during a specific period of time, while they are forbidden to access when they are not on the duty.

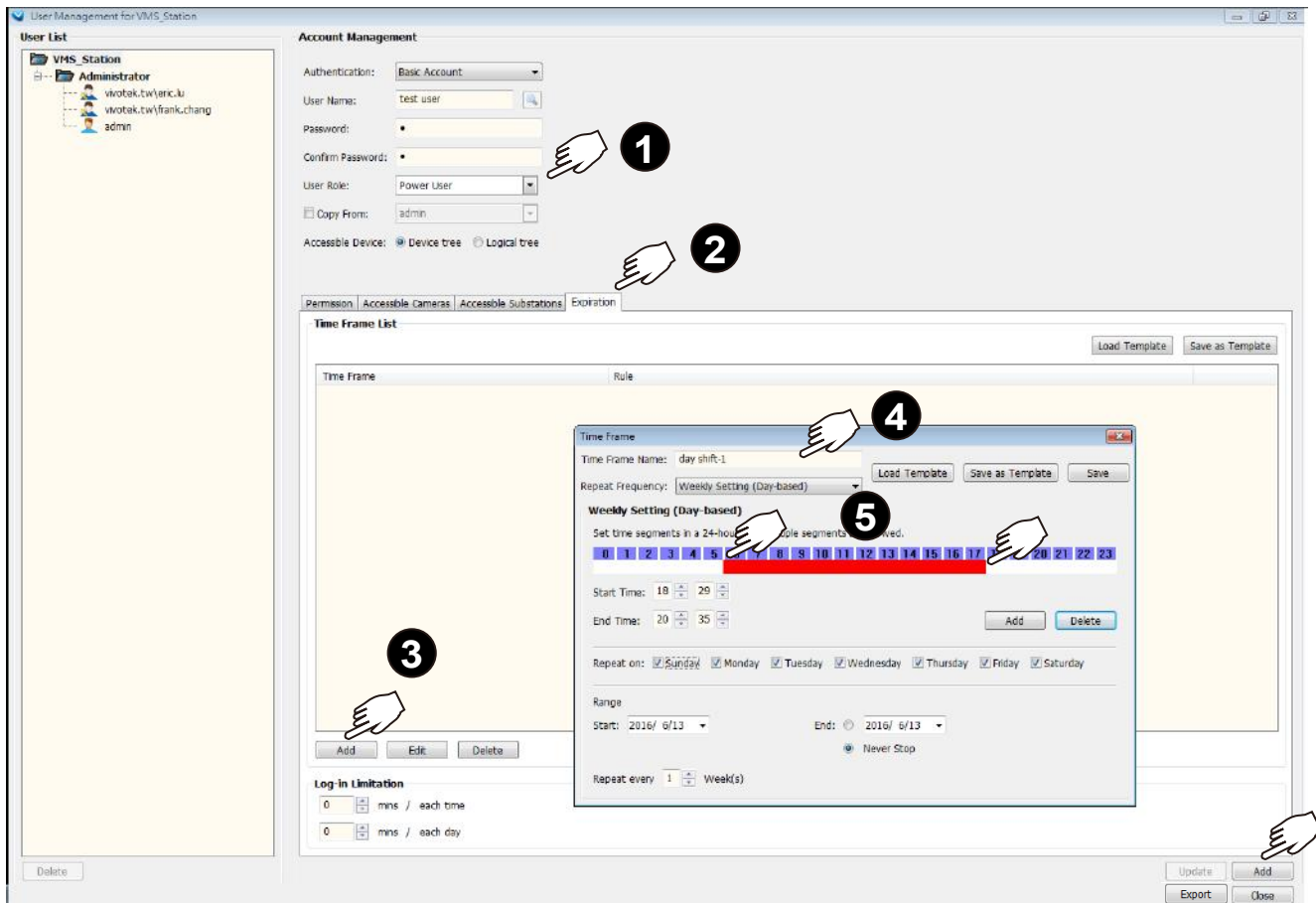

Note that if a new user has the **Administrator** privilege, no Expiration setting will apply to him. The Expiration setting applies to **Power User, User, Operator, or Guest**.

1. To start the configuration, enter a user name, password, and then select a **User Role**.
2. Click to enter the **Expiration** tab window.
3. You can either **Load a Template** or click **Add** to manually configure an Expiration setting. You may also configure a Log-in Limitation by configuring the extension of time a user can access for each day or each login.
4. If creating a new template, enter a name for the template.
5. Drag your cursor across the timeline, or manually enter the **Start** and **End** time. Click the **Add** button if you manually enter the time span. You can add multiple time spans to the timeline. The time spans will display on screen as red bars.

To delete a time span, click to select a time span and click the **Delete** button.

When done with a manual template configuration, you can click the **Save** button to save the template for later use.

**Export:** Click to export users' privilege, access list, as a CSV file. The information include Functions Permission, Accessible Cameras, and Accessible Substations. The Logical Tree access information is currently not included.

## How to Set up Association Management

VAST LiveClient supports association management which allows the user to configure relative event trigger notifications of connected network devices. (E.g., DI/DO status on the hierarchical management tree, motion detection windows appear in the video cell, the event list in the event window)

### Association Management

Please follow the steps below to configure association settings:

- Select the station from the hierarchical management tree.
- Click **Configuration > Association Management** on the menu bar (or **right-click** the station and select **Association Management**).

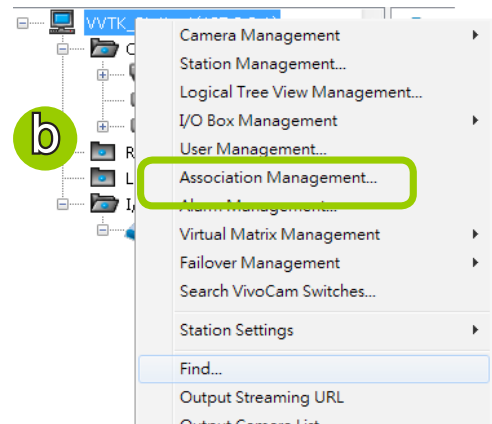
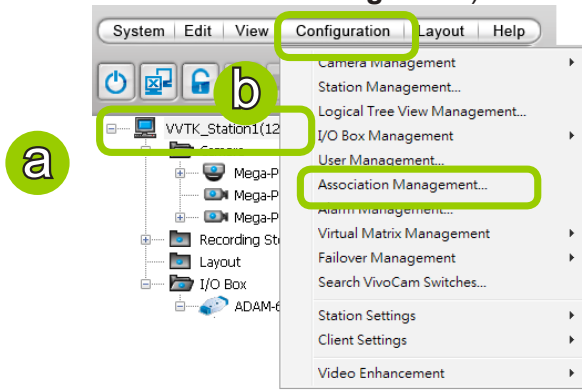

- The **Association Management** window will prompt. Select or deselect the items and click **Save** to enable the settings. The items you've selected will also be displayed under the hierarchical management tree.

For example:

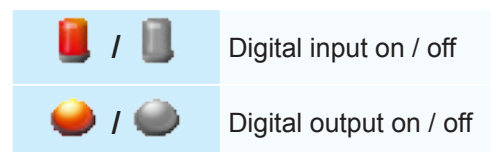
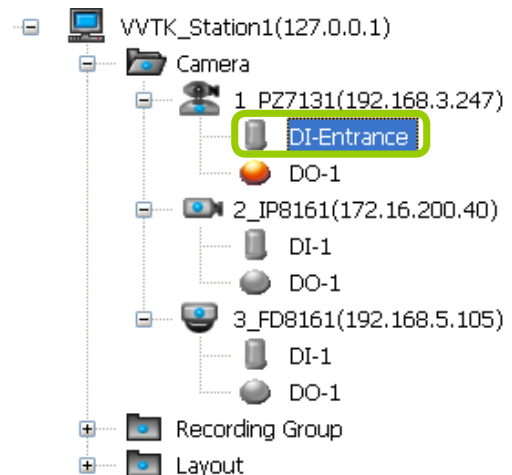
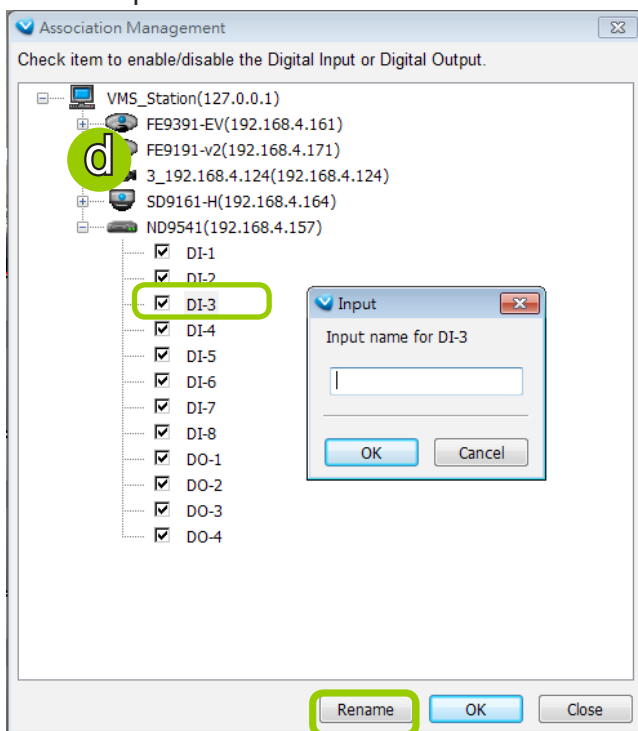

- If you want to rename the DI device, select the DI item and click the **Rename** button. It will be very convenient for you to recognize the target DI device.



- To manually enable DI/DO settings, please **right-click** the video cell and select **Set DO** to enable (**Trigger**) or disable (**Normal**) the digital output of the linked device.

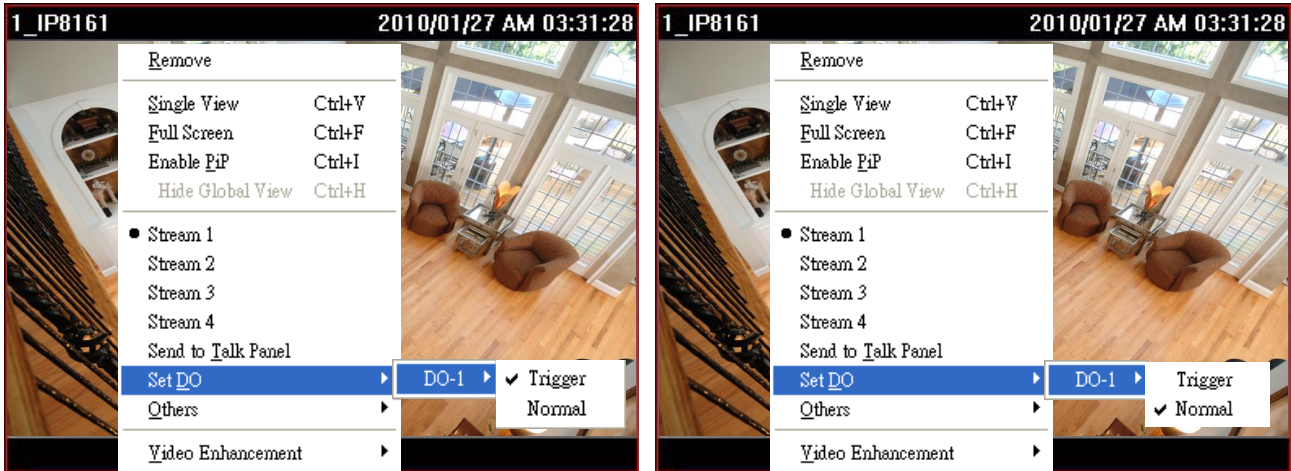

- Before you configure the DI/DO Settings for VAST, please enable DI/DO settings on your network device and set up the camera correctly on the configuration page. You can **right-click** the device and click **Camera Settings** to open the configuration page.

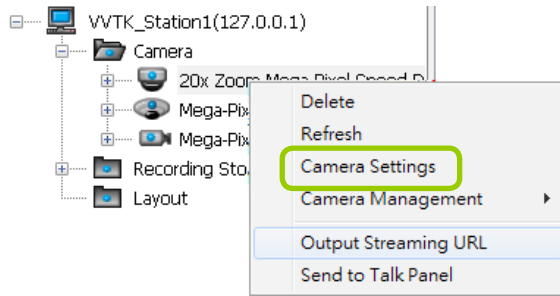

Home Client settings **Configuration** Language

Applications > DI and DO

System  
Media  
Network  
Security  
PTZ  
Event  
Applications  
Motion detection  
DI and DO  
Tampering detection  
Audio detection  
Package management  
Recording

**Digital input**

Normal status:  High  Low

Current status: **High**

**Digital output**

Normal status:  Open  Grounded

Current status: **Open**

## How to Set up Alarm Management

VAST LiveClient supports Alarm management which allows the server to display and respond to particular situations (events).

### Alarm Management

Please follow the steps below to configure Alarm management:

- Select the station from the hierarchical management tree.
- Click **Configuration > Alarm Management** on the menu bar (or **right-click** the station and select **Alarm Management**).

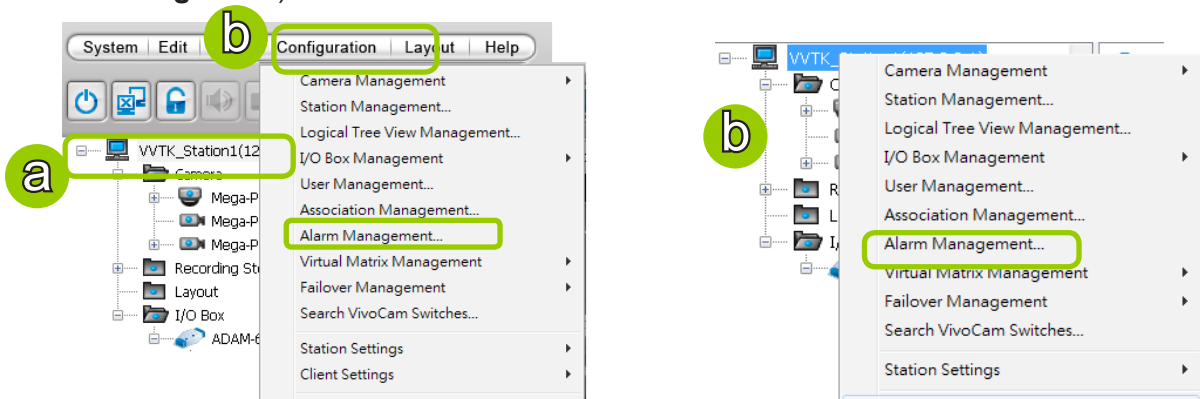

- The **Alarm Management** window will prompt. Click **New** to configure a new event. Enter a name and description for the new alarm. When you finish the general settings, click **Next** to set up trigger source settings. The Alarm name you specify here will be displayed on the Alarm panel in the Live view.

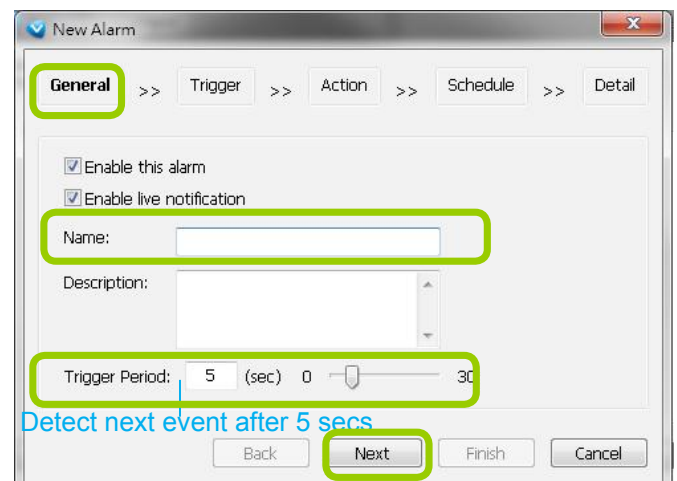
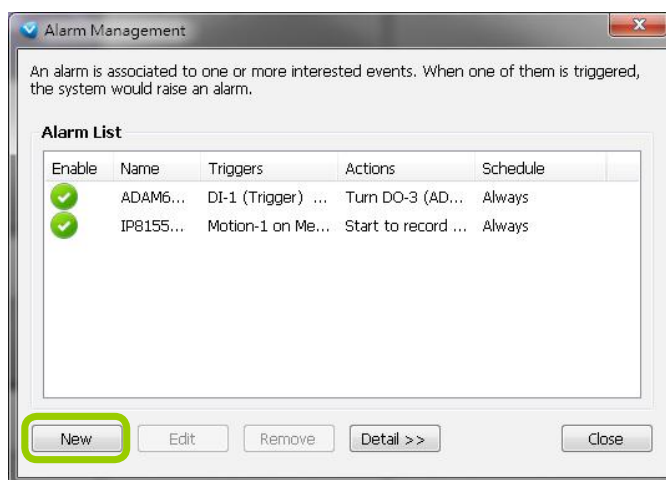

d. Click **Add** to select the trigger source by Device or Trigger Type.

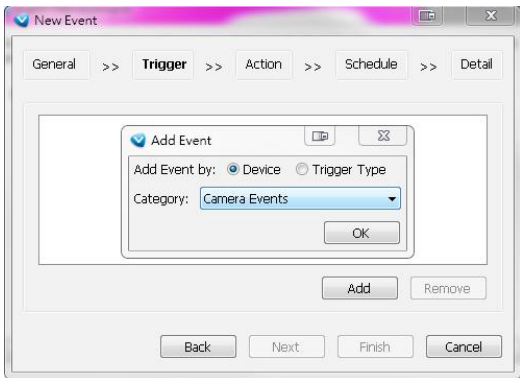

Note that the **Motion detection** windows are separately configured using web consoles with each individual cameras. Open a web console with the camera to configure Motion detection windows.

The Storage Status includes: Storage connection status and storage capacity status on NVR systems.

Each individual motion detection window can be used as a triggering condition. The Line Crossing and Field Detection packages running on cameras also apply as triggers.

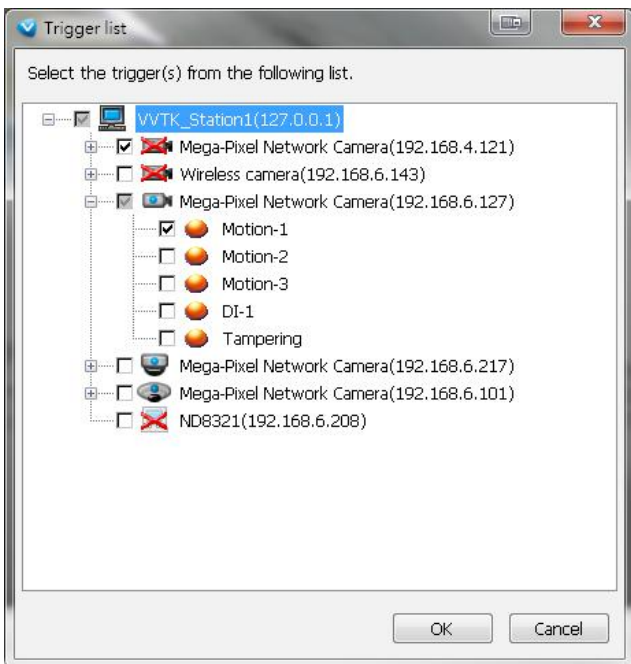

If you connect your DI/DO devices via an I/O module (I/O box), please refer to page 307, **Appendix E Support for Digital I/O Modbus TCP Modules** for details.





There is a new event trigger type, P-PTZ. The P-PTZ refers to the occurrence of Auto Tracking action in a Panoramic PTZ configuration.

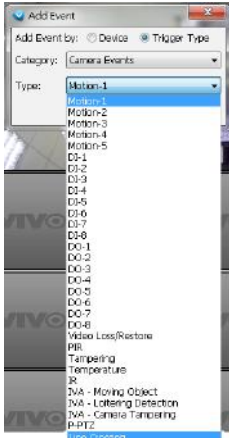

Auto Tracking is configured on the fisheye camera in a Panoramic PTZ configuration.

If you manually configure a detection area for the Auto Tracking function, the P-PTZ event will not be triggered.

e. The Device List window will prompt. Select one or more devices and set the Notification Type. Depending on the trigger source, the Notification Type will be different. Then click **OK** to close the window.

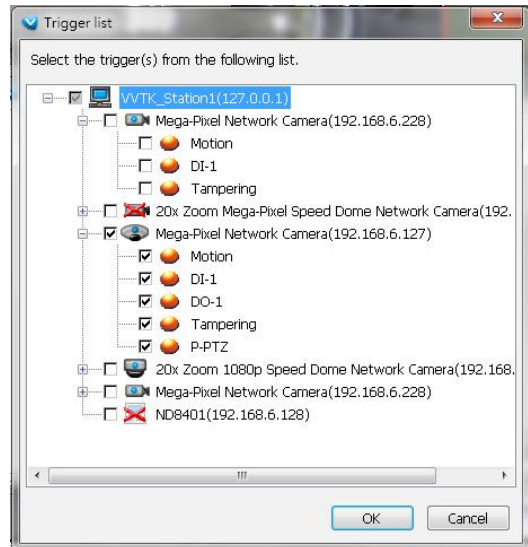
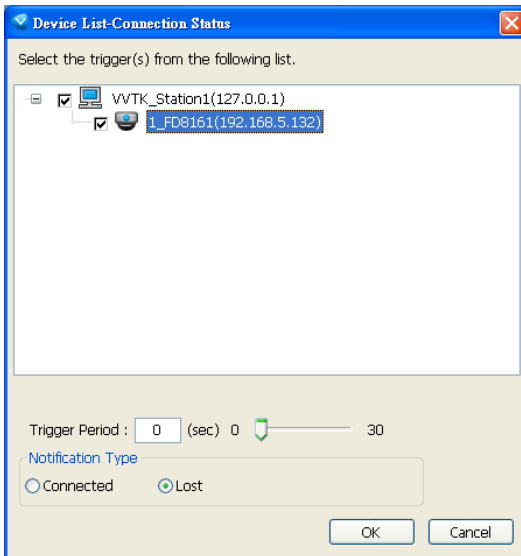

f. The trigger source(s) will be listed on the window as shown below. If you want to add more Trigger sources, click **Add** and repeat steps d. to e. Then click **Next** to assign action(s) to the trigger source(s).

g. Click **Add** to open the **Action** Settings window.

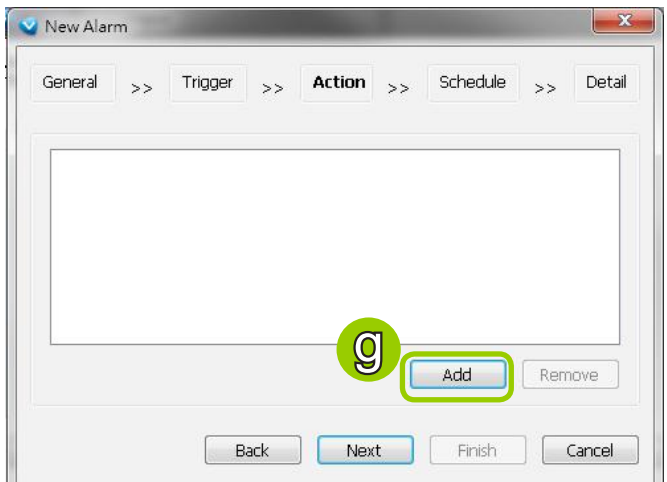
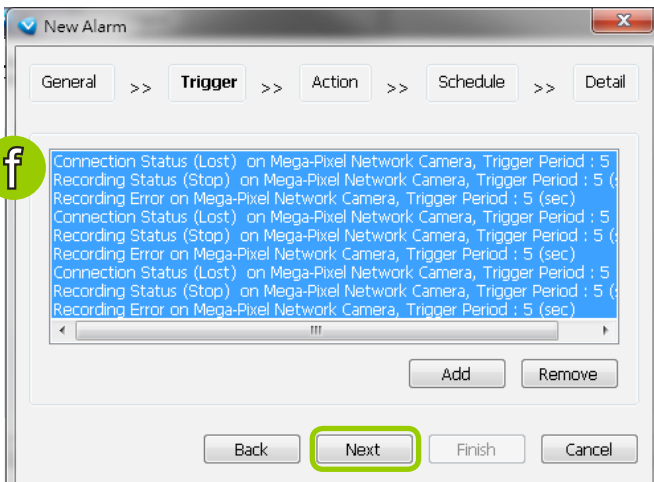

Note that if your camera is using Sony's SR-WM series cards, SD card status events can be used as a trigger.

The event messages look like the following:

Warning	Error Message Examples
Normally Functioning	The SD card is inserted and there is enough lifespan remaining.
Replacement Recommended	Has reached xx% of the SD card's lifespan.
Has Reached its Lifetime	All the spare blocks have been consumed. The card is read-only.
Card Not Inserted	No SD card is inserted.
Failed to Get Status	Unexpected error has occurred.

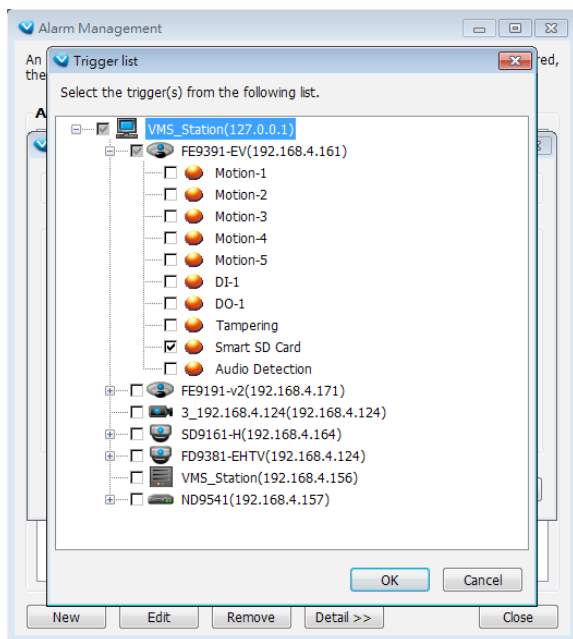

The related event messages will prompt on the event list. On seeing the Smart SD events, you should replace your SD card.

Instant Playback	Name	Description	Source	Event Type	Value	Time	State
<input checked="" type="checkbox"/>	Alarm-3		FE9391-EV	Smart SD Card	Trigger	2017-09-07 16:19:43	New
<input checked="" type="checkbox"/>	Alarm-3		FE9391-EV	Smart SD Card	Trigger	2017-09-07 16:10:19	New
<input checked="" type="checkbox"/>	Alarm-3		FE9391-EV	Smart SD Card	Trigger	2017-09-07 16:09:43	New
<input checked="" type="checkbox"/>	Alarm-3		FE9391-EV	Smart SD Card	Trigger	2017-09-07 16:06:58	New
<input checked="" type="checkbox"/>	Alarm-3		FD9381-EHTV	Recording Status	Stop	2017-09-07 16:01:04	New

The Tampering, Audio Detection, and Shock Detection are also available as a trigger source with cameras that support these features. Shock Detection is available for cameras that come with an acceleration sensor.

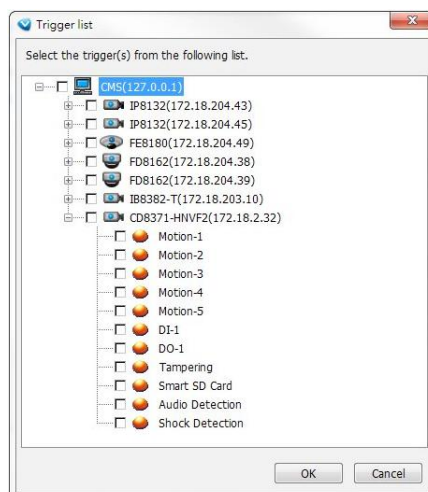

There are several types of Action Settings.

- Email: The sever will send a notification via e-mail when a trigger is activated.
  - h. To enable this function, please set up the SMTP server first. Click **SMTP Setting** to open the window and refer to page 165 for detailed information.
  - i. Enter the related informtaion. You can modify the mail content in the blank. If you want to modify the content, click **Insert Macro** to select the parameter. When completed, click **OK** on the bottom to enable the setting.

Note that you can insert a snapshot taken by the time of alarm occurence of the recorded video. The snapshot will be sent along with the notification Email. The snapshot comes from camer's stream 1.

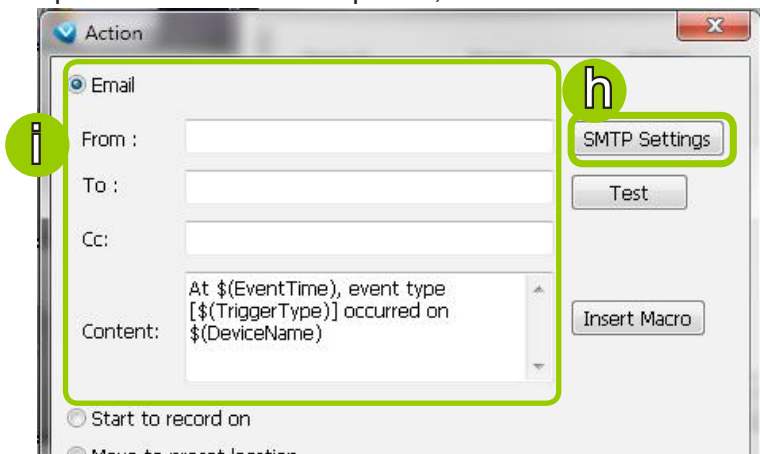

- Start to record on: The sever will start to record video from selected camera(s) when an event is triggered.
  - j. Click **Add Camera** to select the target camera(s).
  - k. The selected camera(s) will be listed on the left window below. When completed, click **OK** on the bottom to enable the setting.

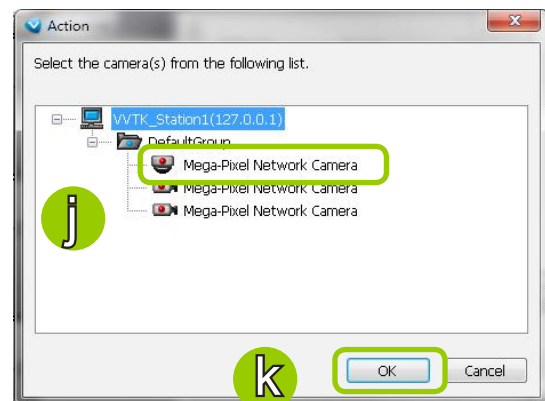
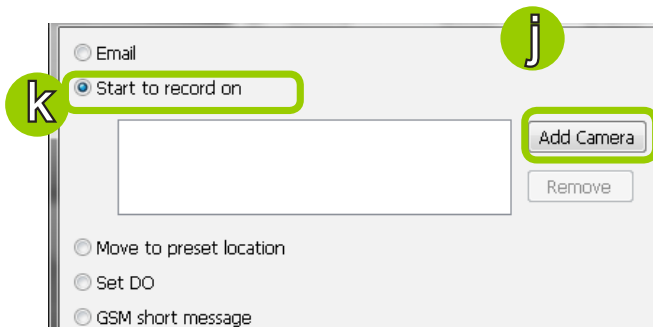

- Move to preset location: The target camera(s) will move the shooting area to the preset location(s) when an event is triggered.
  - l. To enable this function, please configure some preset locations on the camera configuration page first.
  - m. Click **Add Location** to select preset location(s).
  - n. The selected preset location(s) will be listed on the left window below. When completed, click **OK** on the bottom to enable the setting.

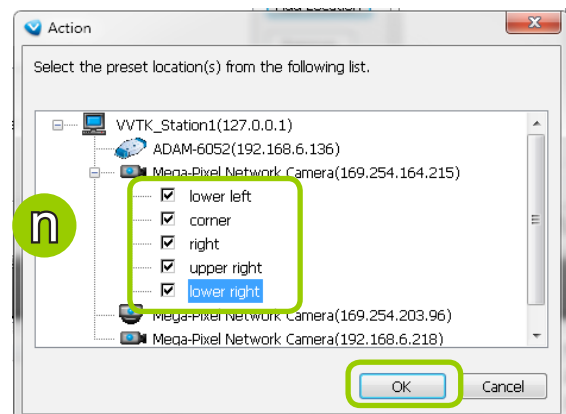
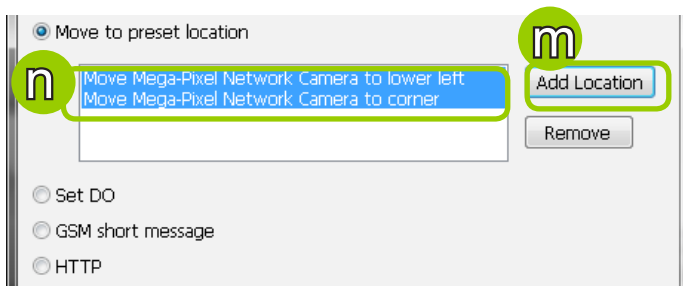

- Set DO: Select this option to turn on external digital output device(s) when an event is triggered. For more information about how to set DI/DO settings on the target camera, please refer to page109.
  - o. Click **Add DO** to select DO device(s) and select a DO status (Normal or Trigger).
  - p. The selected DO device(s) will be listed on the left window below. When completed, click **OK** to enable the setting.

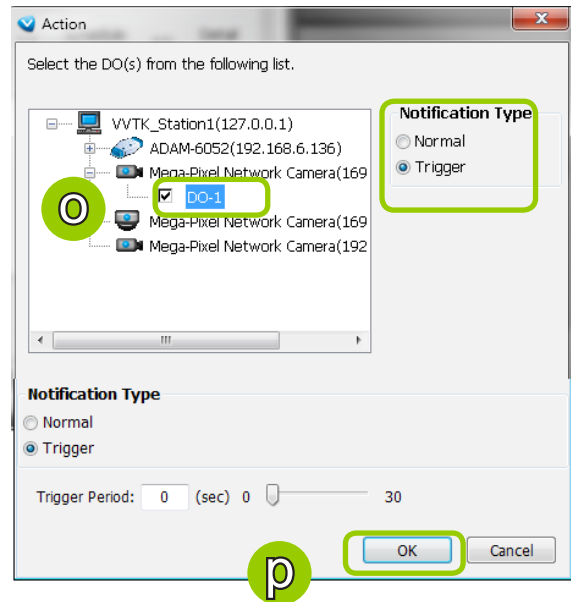
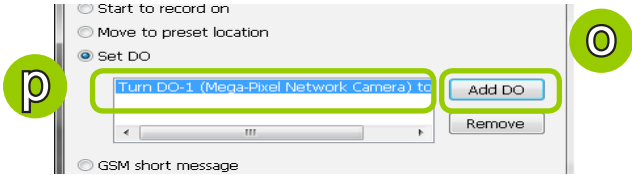

Select the Trigger Period from the slide bar below. The range is 0 to 30 seconds. The DO trigger signal will return to normal after after this period of time.

Note that the Trigger Period setting does not apply to the camera DI/DO managed by substations.

- GSM Short Message: The sever will send a short message to a GSM cell phone when an event is triggered.
  - q. Please enter the Phone Number and open **GSM Settings** window to set related information if necessary. When completed, click **OK** to enable the setting.

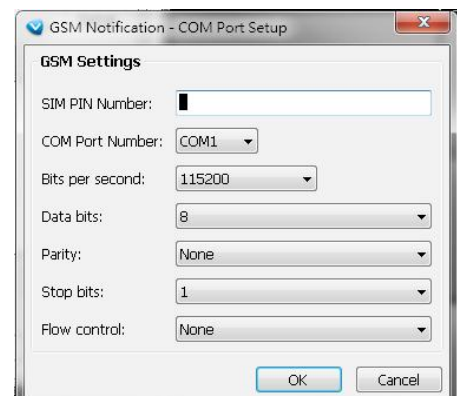
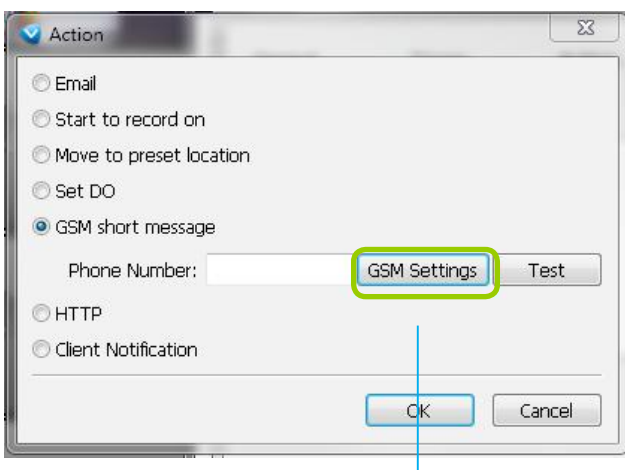

Please enter the country code if you use overseas call.

- HTTP: This function allows user to send a CGI command to the linked network camera, such as pan/tilt/zoom function or enable DO devices.
  - r. You can click **Insert Macro** to select the parameter. Please enter authentication information if necessary. For example: `http://192.168.3.66/cgi-bin/admin/setparam.cgi?system_hostname=$(EventTime) $(CameraName)`  
 If you want to use special characters such as `$_.*!*( ),#%+$,@:;/?=&`, please refer to the following table to transfer the Code (Hex).  
 For example: `http://192.168.3.66/cgi-bin/admin/setparam.cgi?system_hostname=123&456`  
 --> `http://192.168.3.66/cgi-bin/admin/setparam.cgi?system_hostname=123%26456`

Character	Code (Hex)	Character	Code (Hex)
!	21	,	2C
#	23	-	2D
\$	24	.	2E
%	25	/	2F
&	26	:	3A
'	27	;	3B
(	28	=	3D
)	29	?	3F
*	2A	@	40
+	2B	-	5F
		~	7E

- Client Notification: On the occurrence of an event, a pop-up window will display to show what is triggering the current event. Select the window size, and select the display duration of the notification window. If not selected, the notification window is manually closed.

Include the event triggering camera: You can select to display the screens of other cameras (e.g., cameras that are closely adjacent) when the notification prompts.



s. The action(s) will be listed in the window as shown below.

Then click **Next** to set up schedule(s) to the action(s).

For more information about **Schedule Settings**, please refer to Recording Schedule Settings on page 141. You can assign more than one time frame to one action.

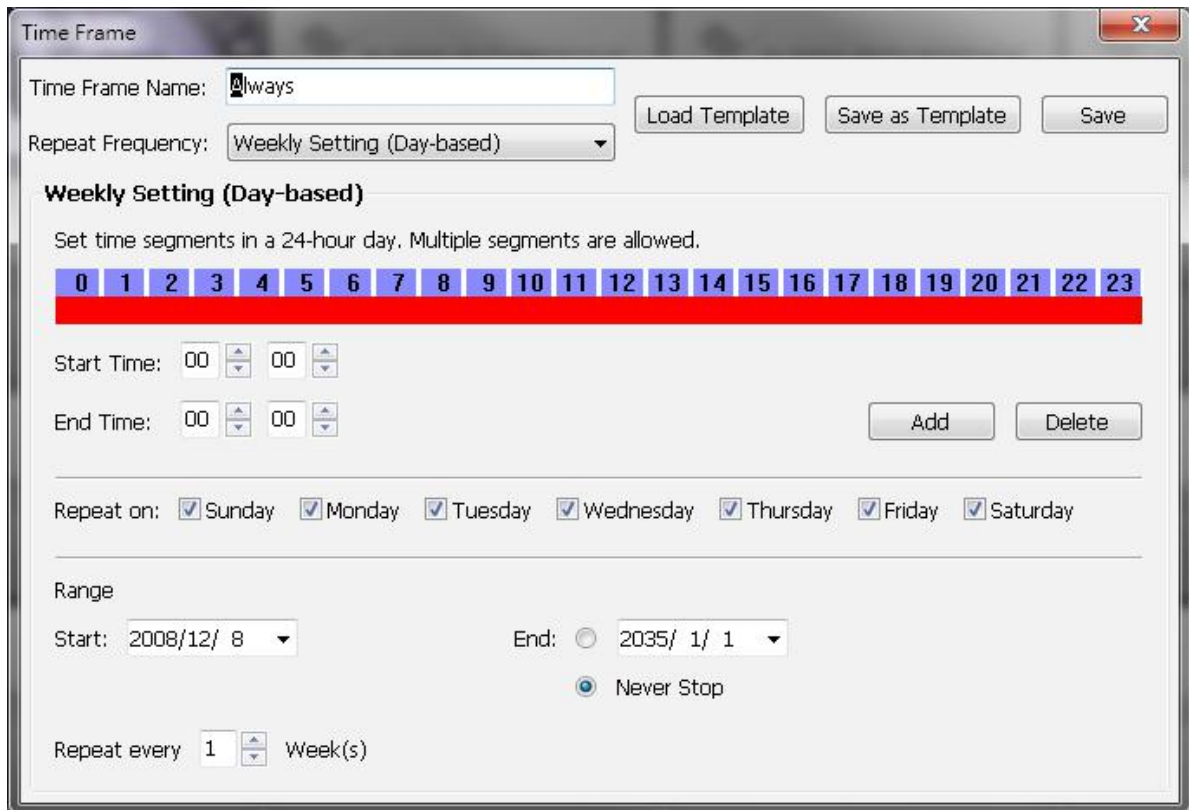
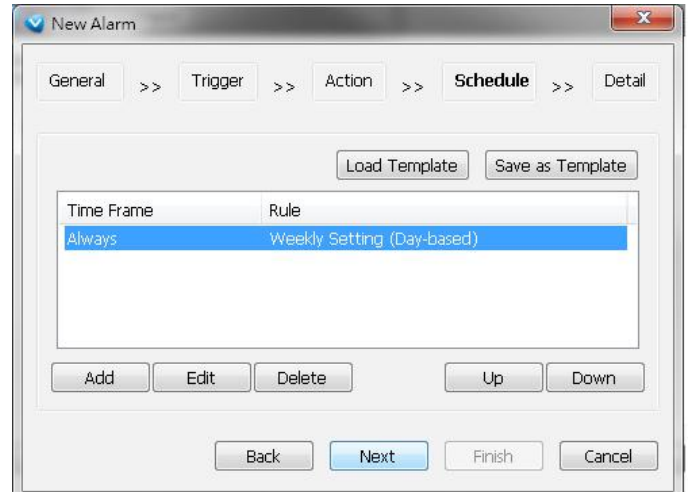
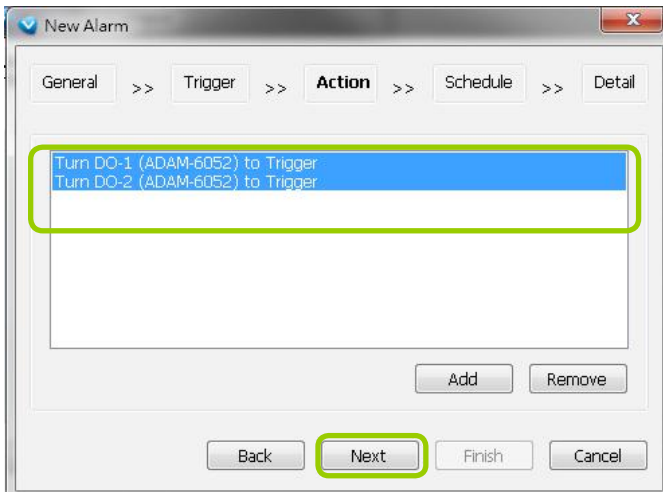

t. When you finish schedule settings, click **Next** to review the detailed information of the new event settings.

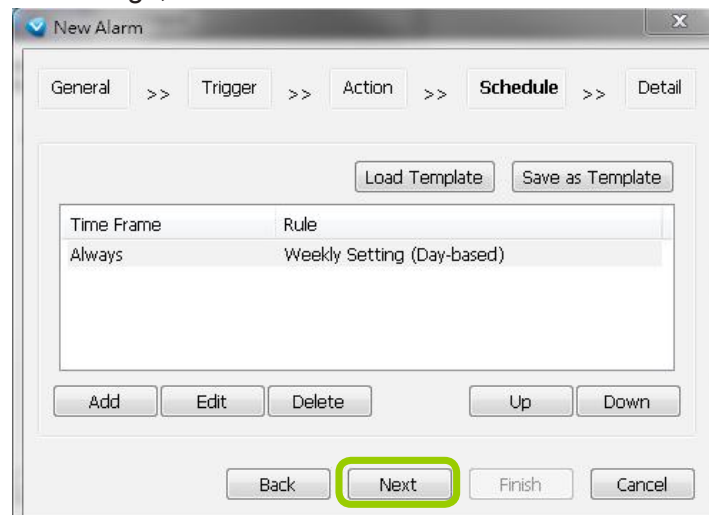

u. Following is the detailed information of the new event setting. You can click **Back** to modify the event setting or click **Finish** to close the window.

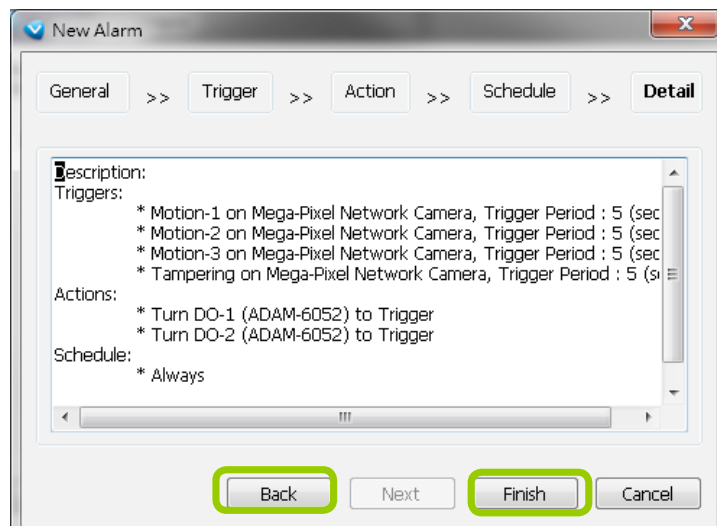

v. Following is an example of an enabled event. You can click **New** to set up more events or click **Close** to exit the window.

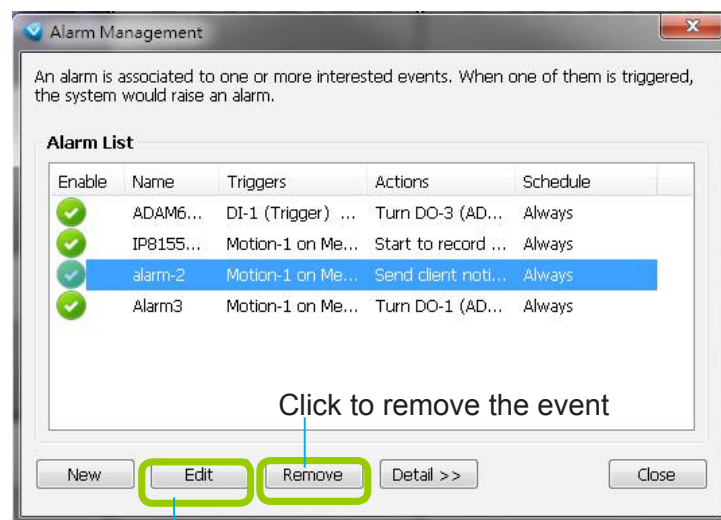

Click to disable or modify the selected event

If your target station has sub-station(s), the **trigger sources** can be selected from the device(s) under the sub-station(s); while the **actions** can only be performed on the device(s) under the target station.

### Alarm Notification Windows

With multiple alarms simultaneously triggered, the notification windows will appear consecutively at the four corners of the screen. With more than 4 alarms, the latter notifications will appear on top of the old ones at a slightly shifted position.

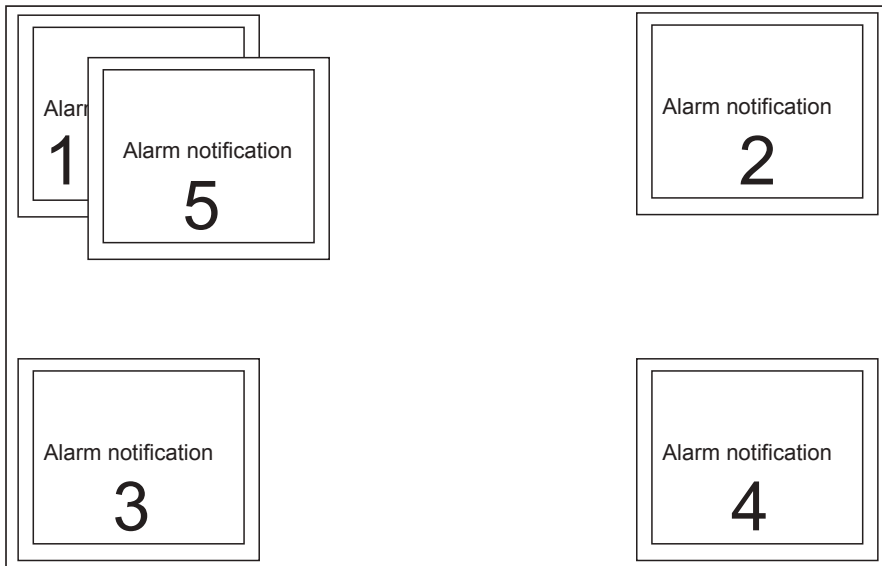

### Fisheye Motion Windows

When fisheye cameras are configured with Motion Detection windows and their motion events are triggered in the notification windows, they display in a more comprehensive dewarped, regional view.

If the Alarm triggering condition is configured as DI (digital inputs) or other inputs, you can configure the Alarm Action as displaying Client Notification as well. You can select the "Include the event-triggering camera," to display the pre-configured motion windows. The fisheye cameras' motion windows display in the dewarped mode.

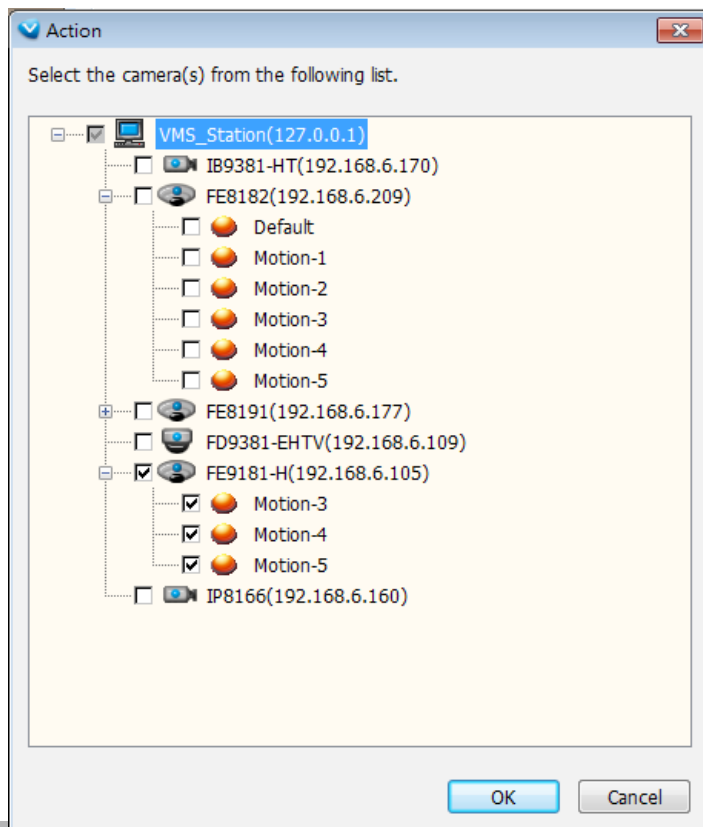



## Export All Logs

In the Playback utility, you can select the Log Viewer tab window, display the past events, and export all event logs to a CSV file.

The screenshot displays the Playback utility interface. The main window is titled 'Playback' and contains a menu bar (System, Edit, View, Configuration, Layout, Help) and a toolbar with various icons. Below the toolbar, there are three tabs: 'Bookmark Search', 'Alarm Search', and 'Log Viewer'. The 'Log Viewer' tab is active, showing a table of system events. To the left of the table is a search panel with filters for Category, User, Result, Log Type, and Log Level, along with a 'Search' button. Below the search panel are options for Time Zone, Start Time, and End Time. At the bottom of the search panel are buttons for 'Clear All Results', 'Trace Login Activities', and 'Export All Logs'. The table of events is as follows:

Index	Time	Time Zone	Category	Level	Type	Result	User	Target	Description
1	2016-06-13 14:42:45	+08:00	Operation Log	Normal	Login	Success	admin	Local	(LN
2	2016-06-13 14:55:12	+08:00	Operation Log	Normal	Update Alarm Manage...	Success	admin	Local	Sch
3	2016-06-13 14:56:53	+08:00	Operation Log	Normal	Update Alarm Manage...	Success	admin	Local	Sch
4	2016-06-13 14:57:15	+08:00	Operation Log	Normal	Update Alarm Manage...	Success	admin	Local	Sch
5	2016-06-13 14:57:30	+08:00	Event Log	High	Alarm Trigger	Success		Local	Alar
6	2016-06-13 14:57:30	+08:00	Event Log	High	Alarm Trigger	Success		Local	Alar
7	2016-06-13 14:57:30	+08:00	Event Log	High	Alarm Trigger	Success		Local	Alar
8	2016-06-13 14:57:46	+08:00	Event Log	High	Alarm Trigger	Success		Local	Alar
9	2016-06-13 14:57:46	+08:00	Event Log	High	Alarm Trigger	Success		Local	Alar
10	2016-06-13 14:57:46	+08:00	Event Log	High	Alarm Trigger	Success		Local	Alar
11	2016-06-13 14:59:06	+08:00	Operation Log	Normal	Login	Success	admin	Local	(Pla

On the right side of the interface, there are two camera feed windows. The top one is labeled 'FE9101-H' and shows a close-up of a person's hands working on a device. The bottom one is also labeled 'FE9101-H' and shows a wider view of a person working at a desk with a computer monitor.

## How to Manage the Virtual Matrix

Virtual Matrix is a very useful tool for multiple monitor display and management. Based on the whole surveillance system architecture, it efficiently helps user construct a real-time live video wall in the control center. Under a large-scale hierarchical system, through VAST LiveClient you can only simultaneously monitor up to 128-CH on dual monitors; while Virtual Matrix offers fully extension for numerous channels and screens, thus making VAST a very powerful central management system. Moreover, you can change the layout to 2x2 or 3x3 on each monitor to enlarge the video size, then display the video pages on separate monitor for close-up monitoring.



## The architecture of VAST Matrix

As shown below, the surveillance system architecture is composed of VAST LiveClient, VAST Server with two sub-stations, and VAST Matrix separately on individual hosts. Before constructing the Virtual Matrix, please install and run VAST Matrix Program on Matrix Recipient connected with the video wall. Through the Virtual Matrix connection, you can use LiveClient to log in the root server to remotely manage and display all the live view onto the video wall by easily drag-and-drop. PTZ control is also available as on the LiveClient.

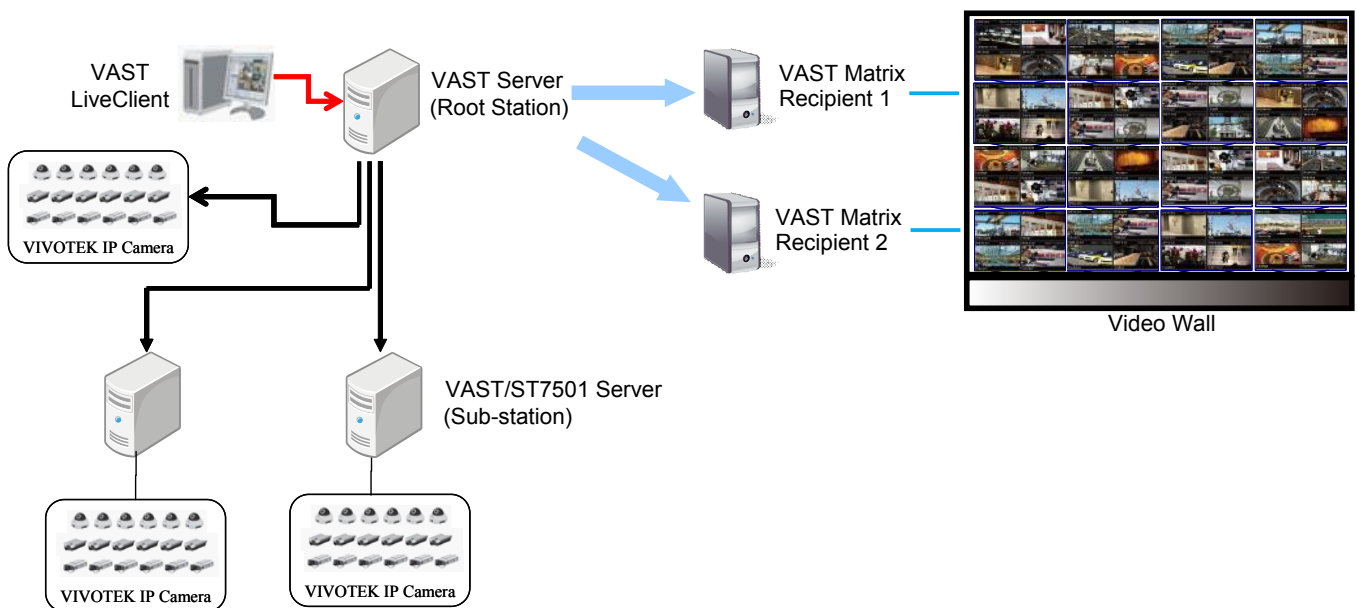

## Installing VAST Matrix Program

Please follow the steps below to install VAST Matrix Program:

- Run **VASTMatrix\_setup.exe** on another host (Matrix Recipient). Then click **Next** to start installation wizard.

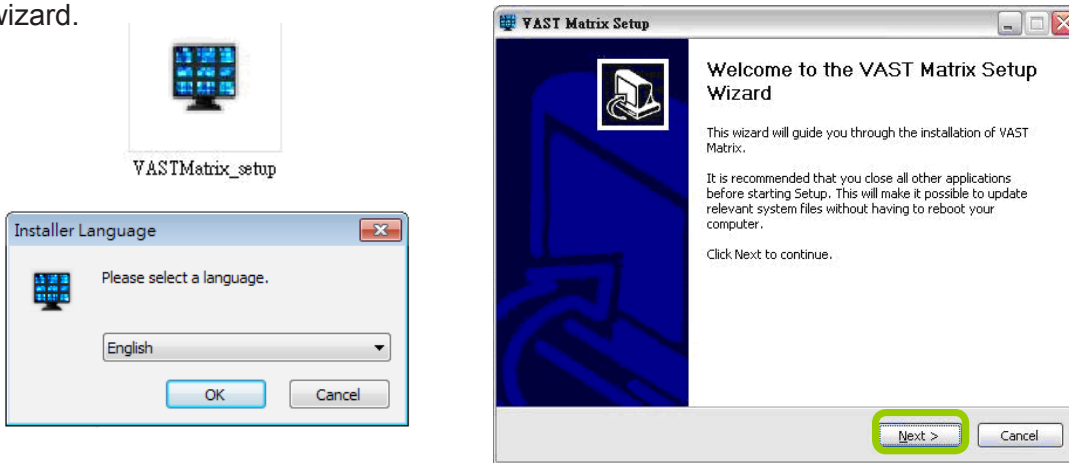

- Carefully read to accept the End-User License Agreement for use. Click **I Agree** to the next step.
- Choose the installing path as the destination folder, the required space and available space of the hard disk will be shown below for reference. Click **Next** to the next step.

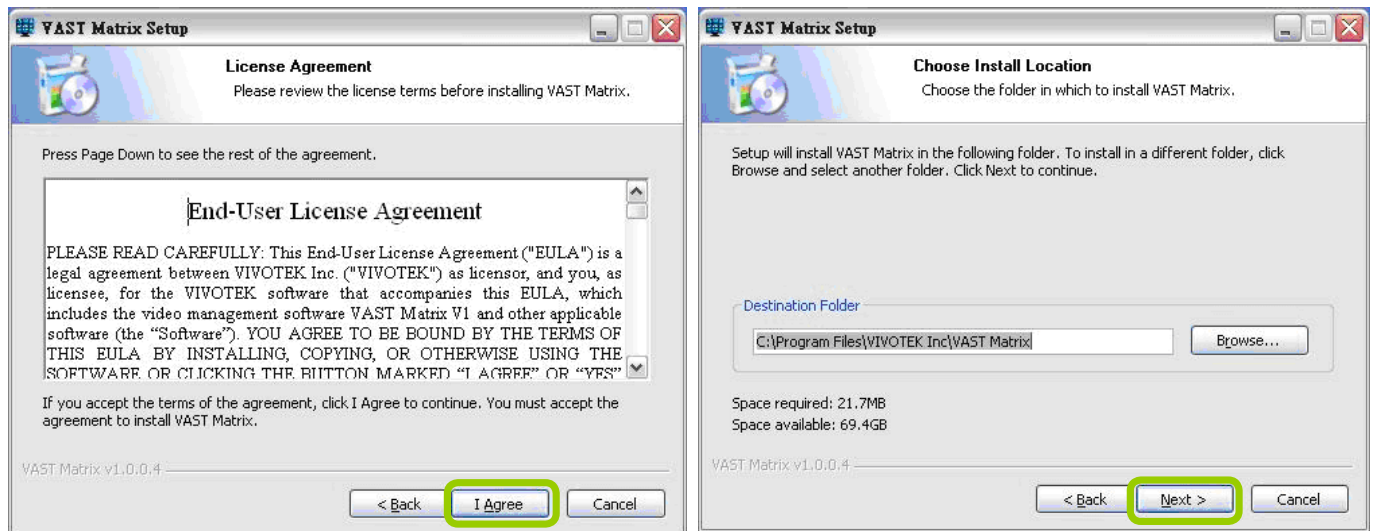

- Fill in the connection information with Port, Account & Password for VAST Server to connect to the Matrix Recipient.

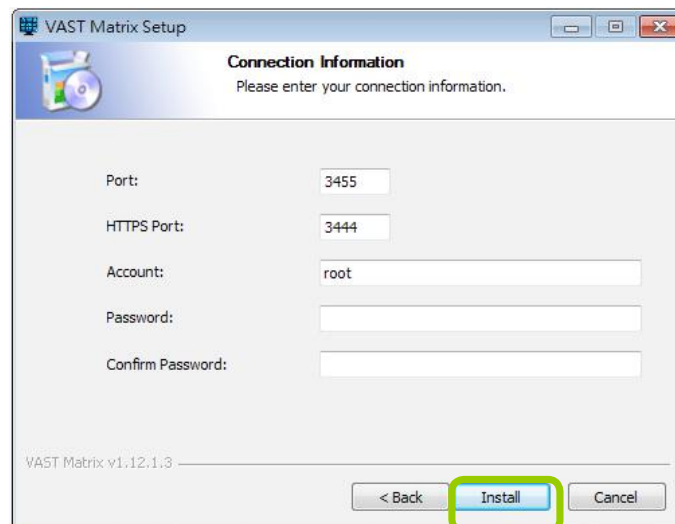

- e. Click **Finish** to close the installation wizard, and you might want to run VAST Matrix immediately after installation by selecting the option **Run VAST Matrix**.

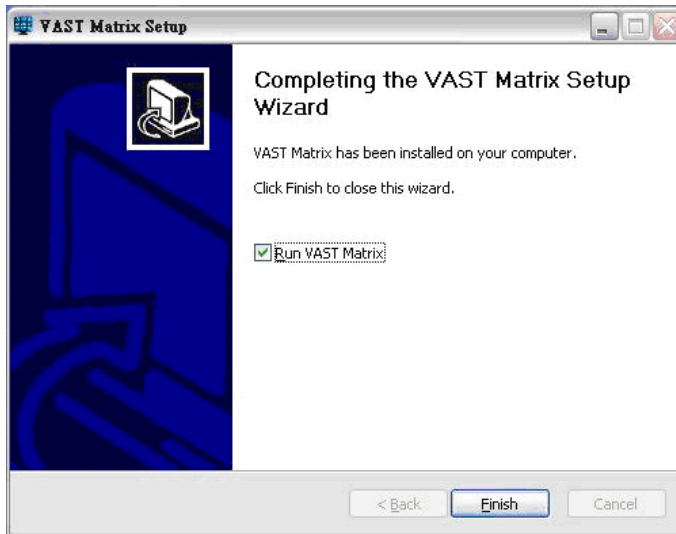

## Launching VAST Matrix

Please follow the steps below to install VAST Matrix Program:

- a. Click the desktop icon to start VAST Matrix. When it's begun running, there will be a VAST Matrix tray icon on the toolbar for the user to configure easily.



- b. The VAST Matrix live view window with multiple types of layout will be displayed. The following shows 32-channels layout.



- c. **Right-click** on the live view window, a function menu will pop up. You may also open the menu by right-click on the tray icon.



## Configuration

- **Connection:** Enter the account, password and port information for the VAST Recipient.
- **Monitor:** It shows the monitor(s) connected to your host. You can select the monitor(s) you wish to display as the video wall.
- **Others**

Auto launch at windows startup: Select this option if you want VAST Matrix to launch when windows starts up in case to avoid the computer reboots by itself and accidentally shuts down VAST Matrix.

Display key frame only: Select this option to display live video with the key frame only in order to save the bandwidth. It also lowers down the CPU loading and memory usage.

Enable de-interlace: Select this option if your linked device does not support de-interlace function. For example: VS7100.

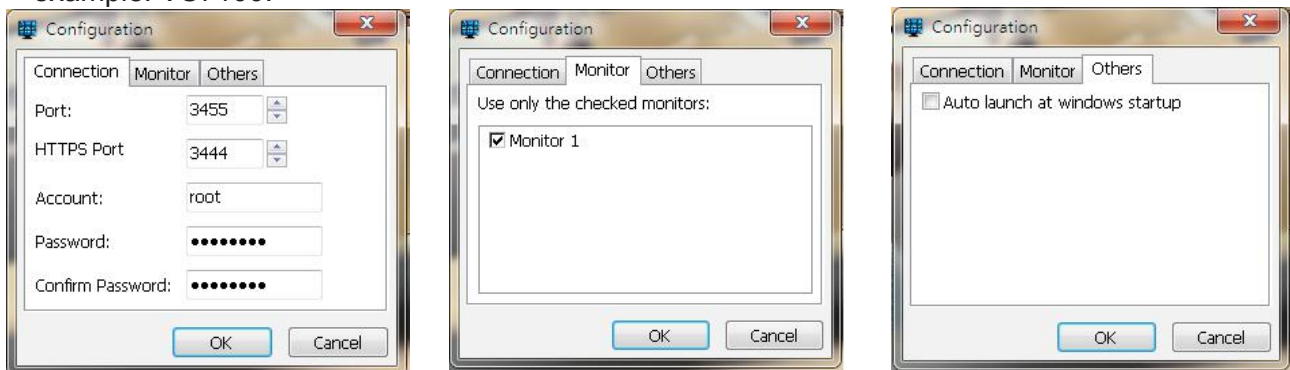

## View Settings

Please refer to page 187 for detailed illustration.

## About

This dialog that shows the version of VAST Matrix and the simple statement of the version copyright.



## Exit

Click to close the VAST Matrix.

## VAST Matrix Management

Once the VAST Matrix Program is setup completely, the next step is to connect the VAST Server with VAST Matrix Recipient(s). Use LiveClient to log in VAST Server, then click **Configuration > Virtual Matrix Management** to configure Matrix Management and Matrix View Settings.

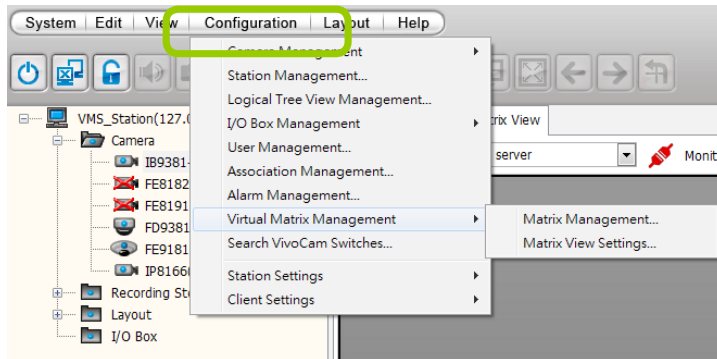



### Matrix Management Settings

Please follow the steps to set up VAST Matrix Recipient(s):

- Click **Configuration > Virtual Matrix Management > Matrix Management** to open the Matrix Management window.
- Manually enter the Matrix Recipient Info as previous settings, or you click the search button  to search for the Matrix Recipient(s) on the LAN.

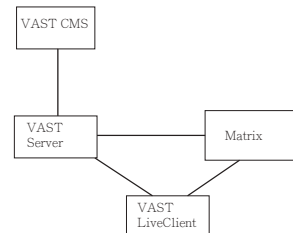
The Managed by menu allows you to let a LiveClient instance manage the Matrix configuration. In normal uses, the configuration is managed by the VAST server.



- When the information of the target recipient is filled in, you can use the detect button  to confirm if the filled information is correct.
- Click **Add**, then the recipient will be displayed on the Matrix Recipients list window.

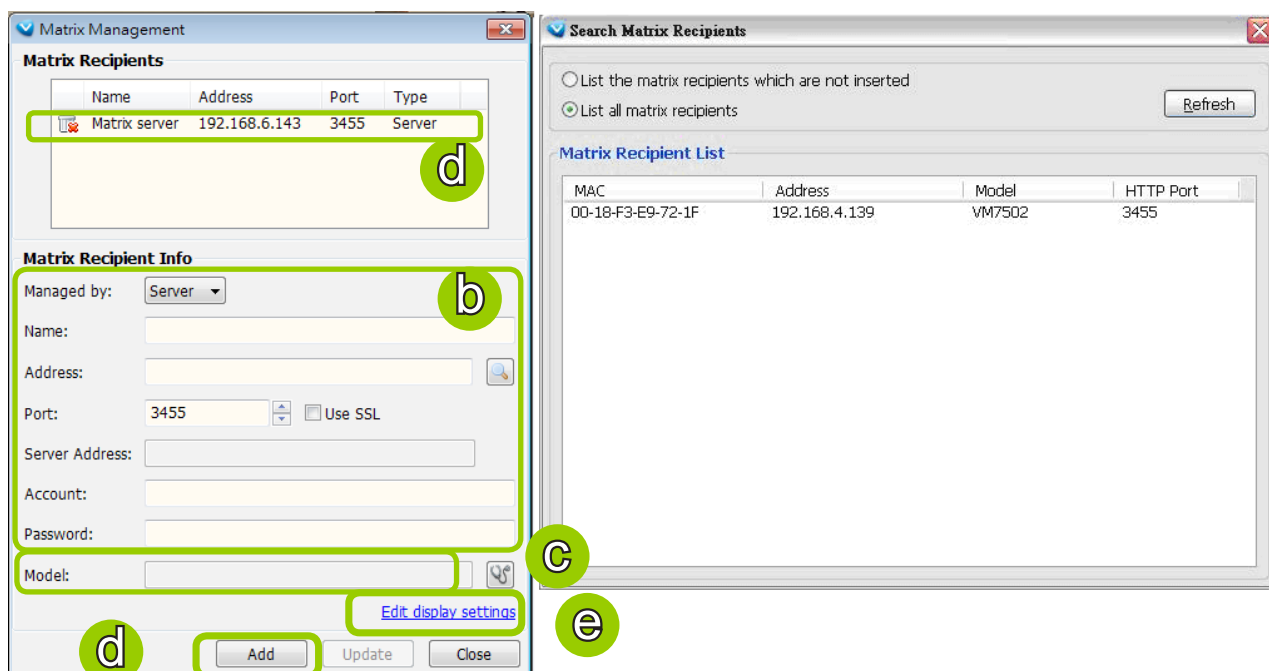



When entering a server address, please avoid entering the XML-related characters: <, >, &, ', and ".

- e. Click [Edit display settings](#) to set up the viewing interface for the monitors (video wall) connected to the Matrix Recipient host.

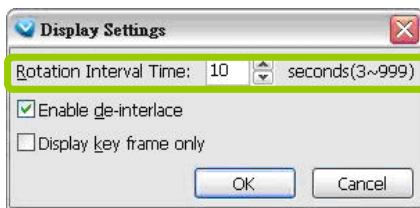

The Matrix View display is capable of executing rotation. The default interval time is set at 10 seconds.

- f. If you want to set up more Martrix Recipients, repeat the above steps.
- g. If you want to modify the Recipient Info, select it from the list to change settings, then click **Update** to enable the new settings.
- h. When all settings are done, click **Close** to exit the Matrix Management page.



Due to the limitations imposed by the Windows UAC (User Account Control), you need to right-click on the Matrix icon to display and "run as administrator," after you close and re-start the Matrix utility.

## Manage VAST Matrix through VAST LiveClient

Once the setup is complete in Virtual Matrix Management, you may go back to the main page of LiveClient, the connection between VAST Server and VAST Matrix will be working successfully. Then you can choose Matrix Recipient and the monitor from the drop-down list for the operation control. Some buttons on the quick access bar will be disabled when you switch from the Live View Panel to Matrix View Panel.

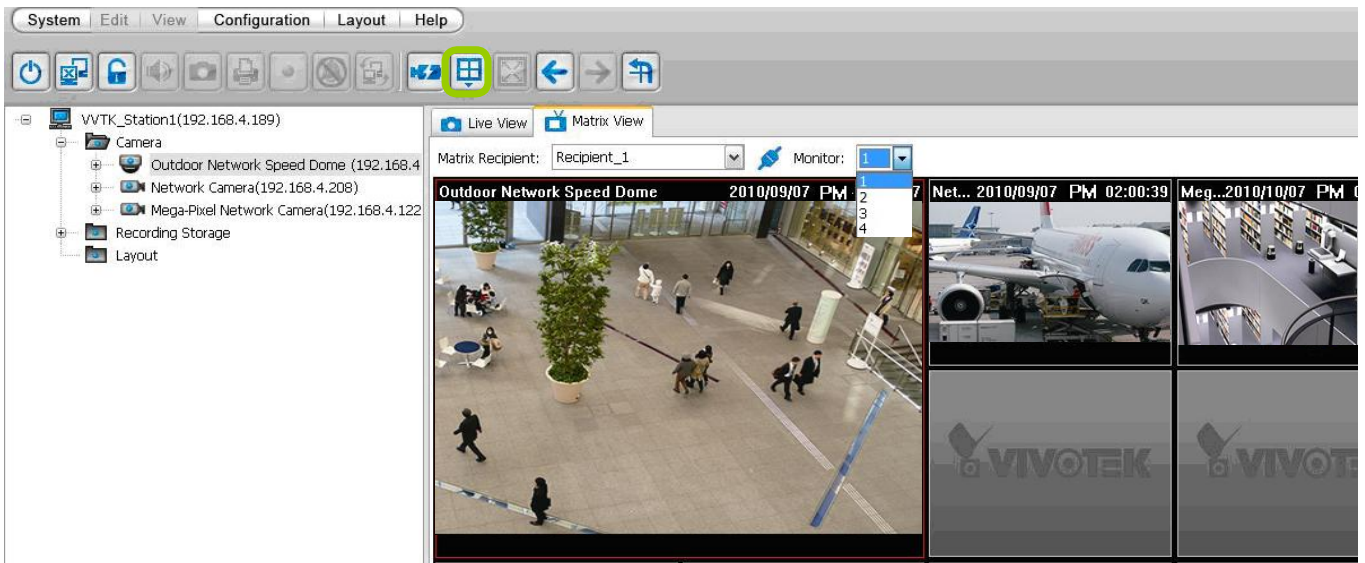

- Change the layout

As the following picture shows, you can click  to change the layout and set new layout group on the Matrix View Panel using the methods same on the use of the LiveClient. The layout on the monitor (video wall) will also change synchronizely once you change the layout on Matrix View Panel.





■ Connection status

If the VAST Server is not able to connect to the Matrix Recipient, the status icon  will become  and show the reason of disconnecting when you slide the mouse to the connection status icon. The "Connection Lost" string will be displayed on the Matrix View window as shown below.

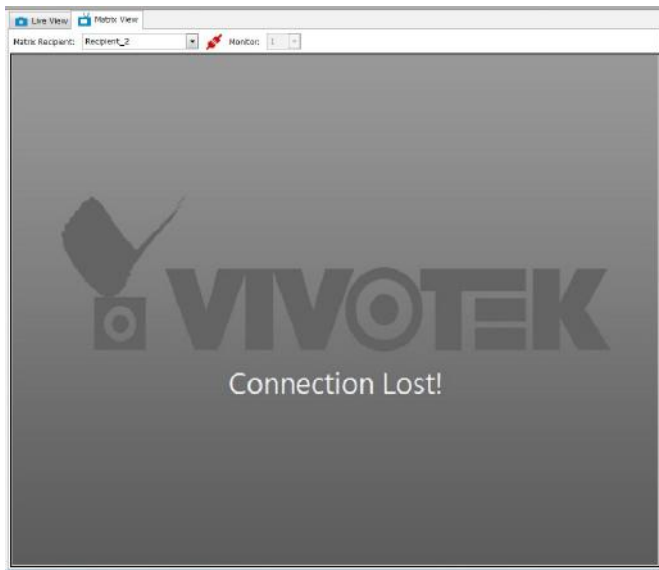

■ Rotation

VAST Matrix is capable of executing rotation by clicking . You can even select another layout group on the Matrix View window without stopping the rotation. If you want to adjust the rotation interval time, please refer to [Edit display settings](#) on page 126 for adjusting.

■ PTZ

VAST Matrix currently does not support PTZ control.

■ Matrix View Menu

Right-click on the window to open the menu.

Remove: Remove the channel from VAST Matrix.

Stream 1 ~ 4: Switch the camera stream between 1 ~ 4.

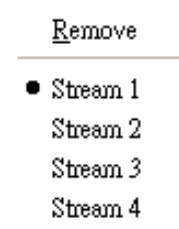

■ Remove All Connections

It's capable of removing all connections from VAST Matrix once by clicking on  button.

## Matrix View Settings

Click **Configuration > Virtual Matrix Management > Matrix View Settings** to open the window.

■ Media Source

You can choose the path of media source from camera directly or the CMS server to display on Matrix View.

■ Display Settings

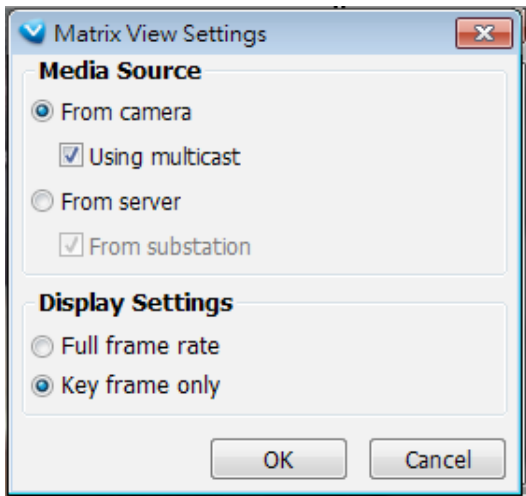

**To configure Multicast video streaming for Matrix,**

Using Multicast configuration help preserve cameras' system resources while streaming video to a Matrix machine. Before applying the Multicast settings, the related network settings should be properly configured on the individual network cameras.

1. Open the web console with the individual network cameras.
2. Enter the Configuration > Network > Streaming protocols window.
3. Change the Multicast settings for Stream 1 on each camera.

Note that it is very important to configure a **unique Multiple Group address** for each camera. Otherwise, images on the view cells will be overlapped, rendering the Matrix view useless. You can also configure the **unique Multicast video port** into a unique number.

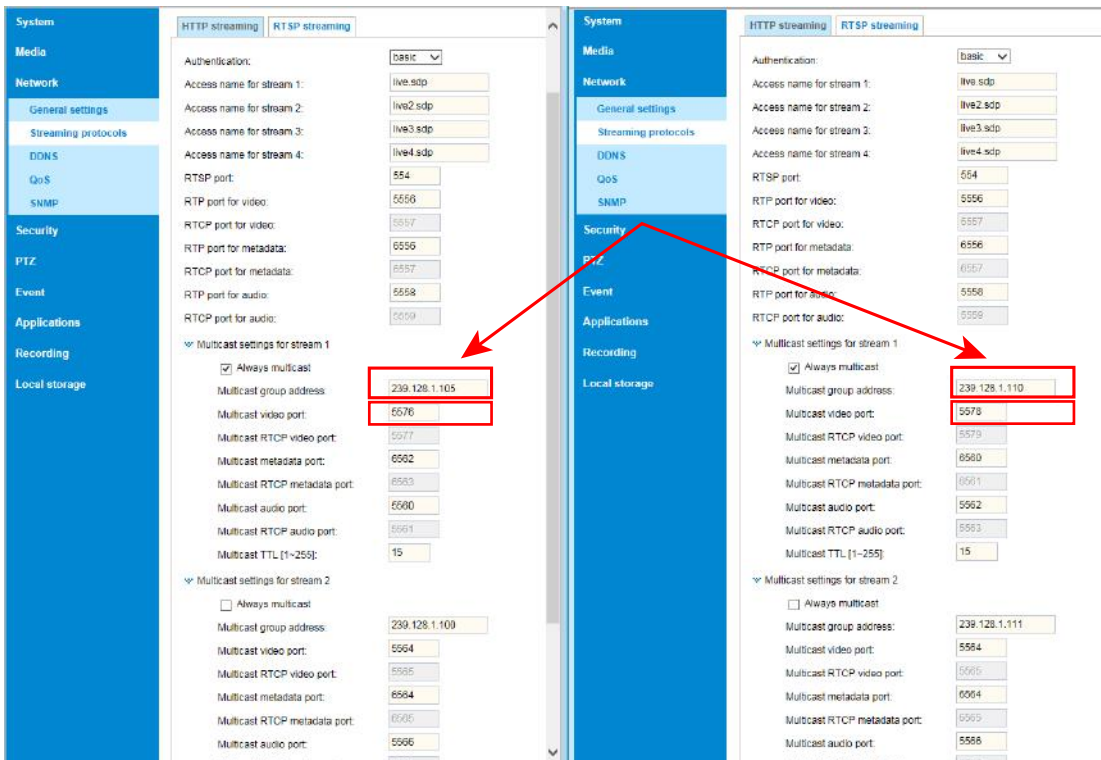

Note that if you change the address, the same address for stream #2, #3, and #4 will change accordingly.

The 239.0.0.0/8 address range is assigned by RFC 2365 for private use within an organization. From the RFC, packets destined to administratively scoped IPv4 multicast addresses do not cross administratively defined organizational boundaries, and administratively scoped IPv4 multicast addresses are locally assigned and do not have to be globally unique.

When finished with configuration, you can use the Wireshark utility to test the presence of multicast packets.

If you select the **Always Multicast** checkbox on the configuration page, multicast traffic will always be detected whether or not the Matrix settings have been synchronized or started between server and the Matrix machine.

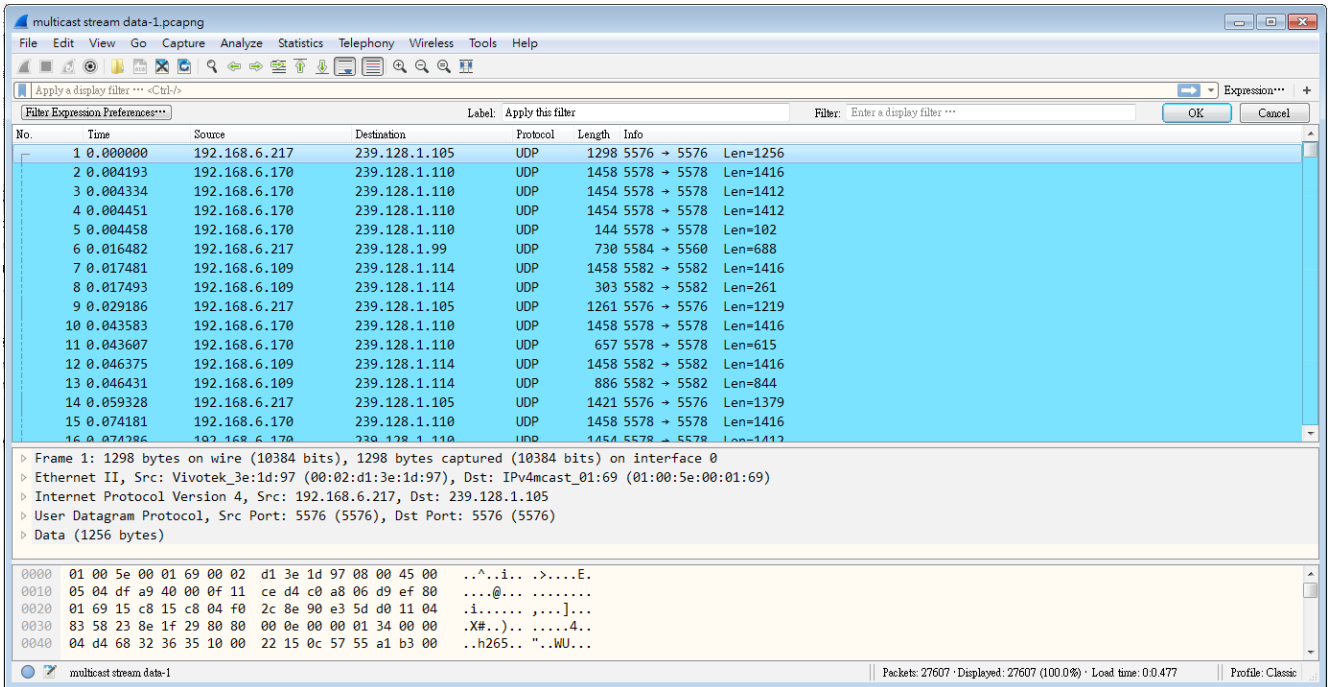

You can choose the display frame rate in the Matrix view as full frame rate or key frame only.

## Search VIVOCam Switches

Use the search managed switch function to locate and open a web console with the managed switches. Double-click on the entry found to open a web console.

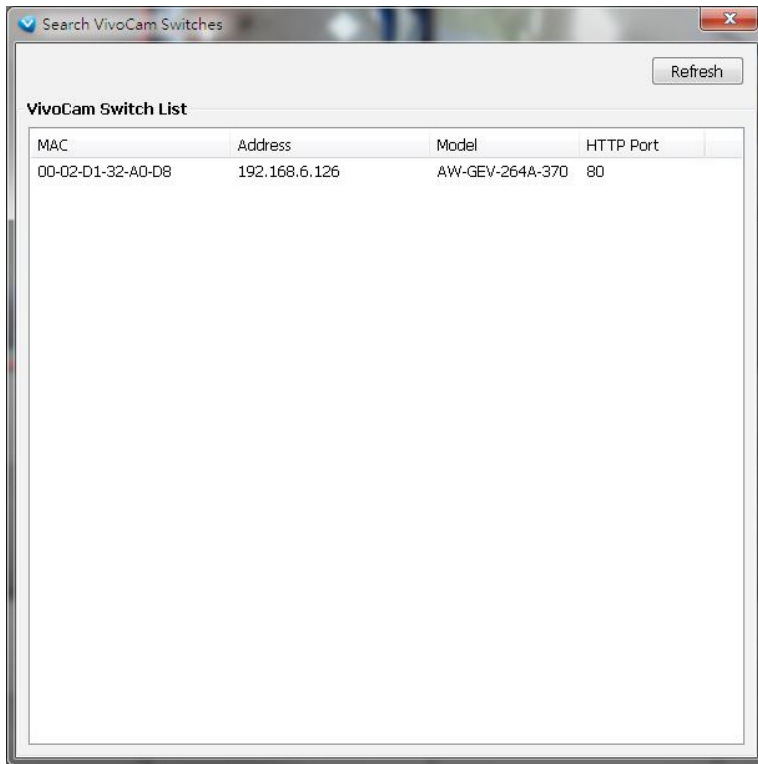
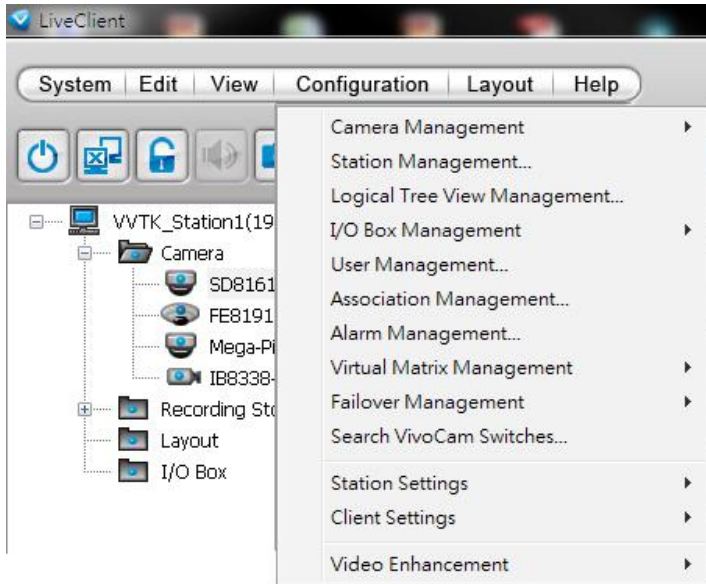

## How to Configure the Station General Settings

Select the target station from the hierarchical management tree, then click **Configuration > Station Settings > General Settings** on the menu bar (or **right-click** the station on the hierarchical management tree and select **Station Settings > General Settings**). The **Station General Settings** window will pop up.

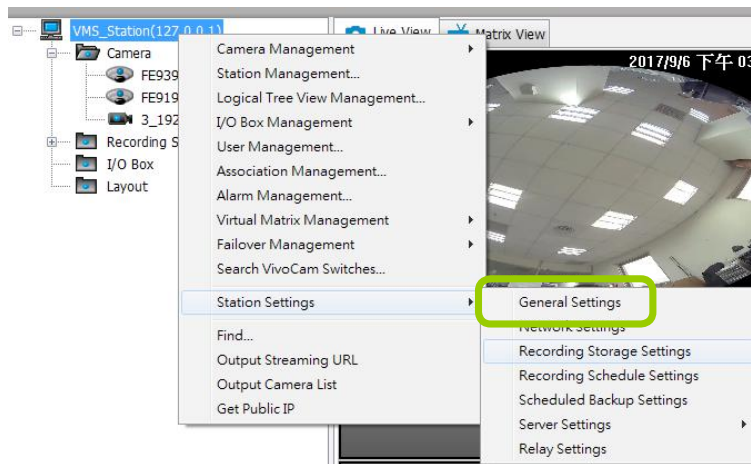
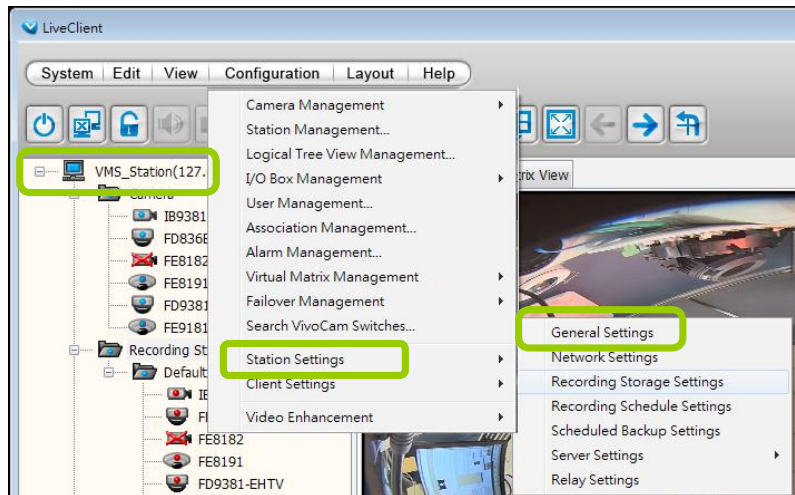

### Server Settings

In this section, you can modify the Station Name.

### Log Settings

In this section, you can set up **Log Settings** for the station.

The VAST server allows user to search for the recorded log through VAST Playback. For more information, please refer to **How to Search Logs** on page 263.

- Log level: Select **High** (only record high-level logs), **Normal** (record high-level and normal-level logs), **Low** (record all logs). For detailed information about log levels, please refer to page 264.
- Reserve Time: Enter the time interval that you want to reserve the log record. The maximum value is 365 days.

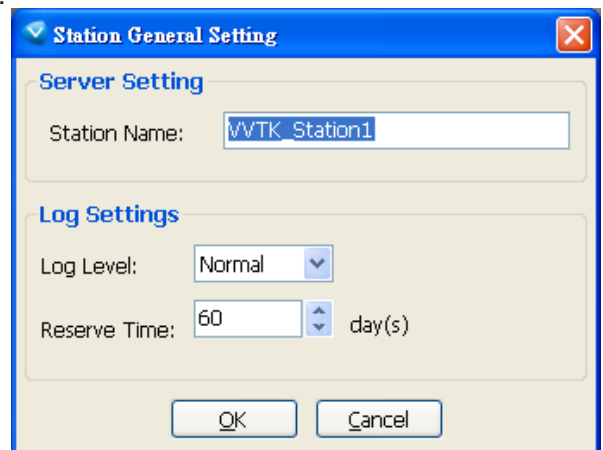

## How to Configure Station Network Settings

Select the target station from the hierarchical management tree, then click **Configuration > Station Settings > Network Settings** on the menu bar (or **right-click** the station on the hierarchical management tree and select **Station Settings > Network Settings**). The **Network Settings** window will pop up.

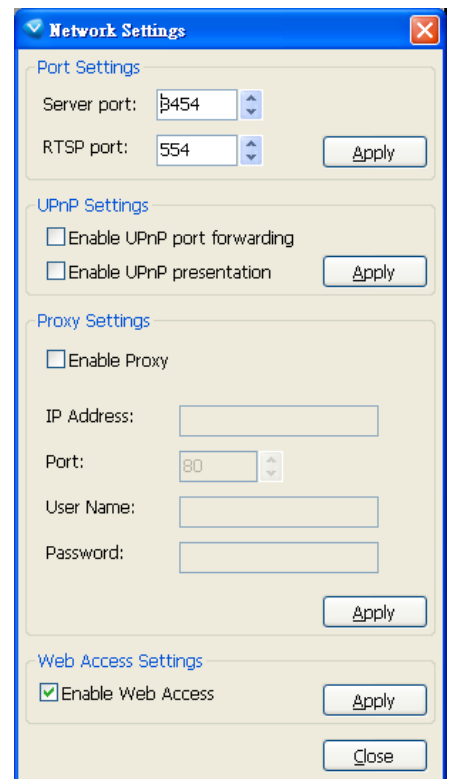
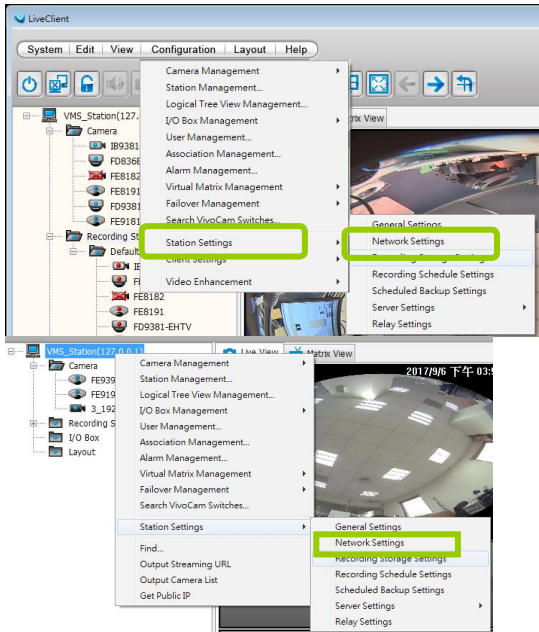

### Port Settings

- **Server port:** The default server port is set to 3454. If you change the server port, please enter the new value while logging the LiveClient next time.
- **RTSP port:** The RTSP (Real-Time Streaming Protocol) controls the delivery of streaming media. By default, the port number is set to 4543.

### UPnP Settings

- **Enable UPnP port forwarding:** For client to access the VAST Server from the Internet, select this option to allow the server to open ports on the router automatically so the video streams can be sent out from a LAN. To utilize of this feature, make sure that your router supports UPnP™ and it is activated.
- **Enable UPnP presentation:** If you select this option, shortcuts to VAST Server will be listed in My Network Places.

### Proxy Settings

In this section, you can enable, modify, or cancel **Proxy Settings** for VAST Server if your network devices are set up under a proxy.

### Web Access Settings

User can access VAST LiveClient and Playback via Internet web browser (<http://IP address:3454>). For local host --> <http://127.0.0.1:3454>. See page 103 for Windows AD account information.

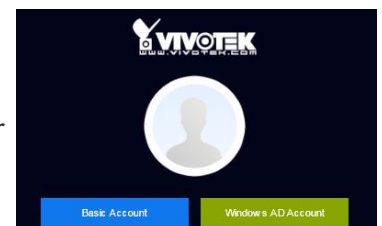

## How to Edit Recording Groups

By default, all devices are assigned to the default recording group. You can manually remove a device from the default recording group. However, only those devices which belong to a recording group can produce recorded media files.

Another purpose of setting recording group is that you can divide all the managed devices into several recording groups, and for each recording group, you can assign several hard-disks (with recording paths) to store media data. The live media data will be stored in the first assigned hard-disk initially, and when the available space of the first hard disk reaches the preset reserved space limit, the media data will be stored in the second disk and so on. If the available space of the last disk reaches the reserved space limit, the recorded files in the first disk will be overwritten with the new media data. This procedure is called "Cyclic Recording".

### Recording Storage Settings

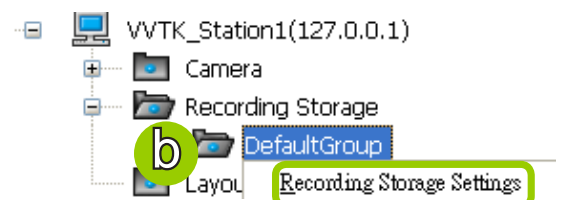
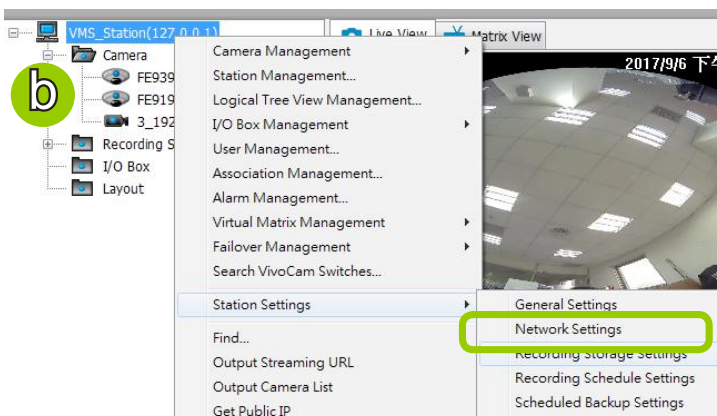
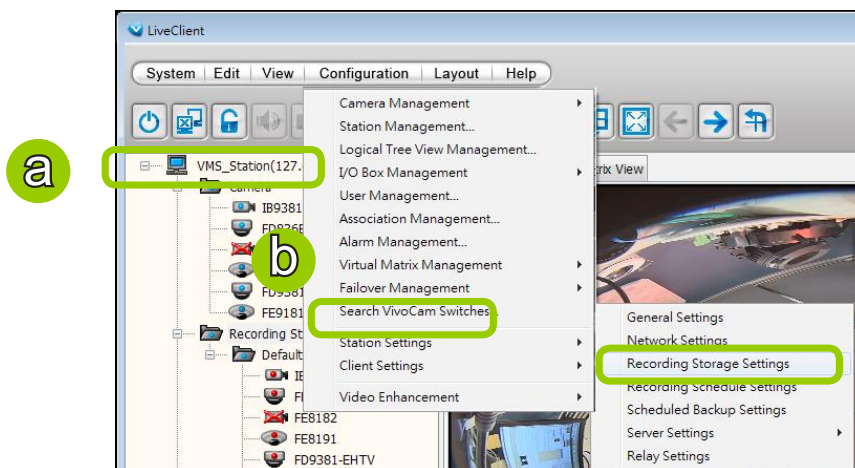

Please follow the steps below to set up recording groups for a station:

- Select the target station from the hierarchical management tree.
- Click **Configuration > Station Settings > Recording Storage Settings** on the menu bar (or **right-click** the station on the hierarchical management tree and select **Station Settings > Recording Storage Settings**). You can also **right-click DefaultGroup** under the station and click **Recording Storage Settings** since all devices are assigned to the **Default Recording Group** by default.





- The **Recording Storage Settings** window will pop up.

### Default Storage Group Settings

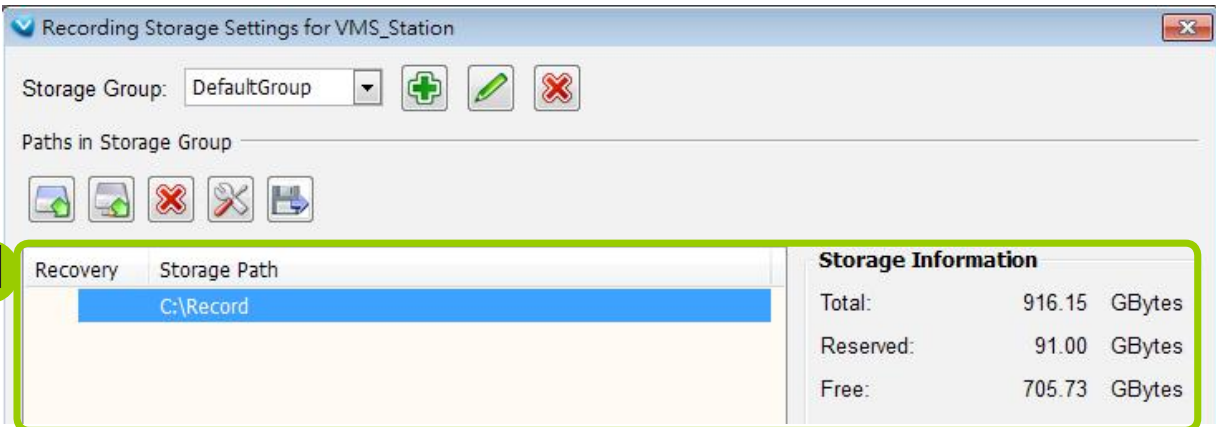
The following example shows the default storage group settings. You can click  **Rename** to modify the group name or click  **Delete** to remove the default settings.



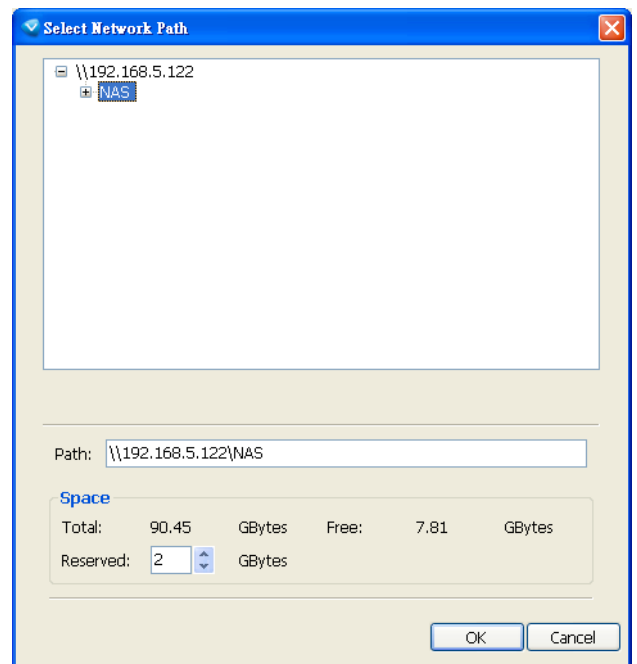
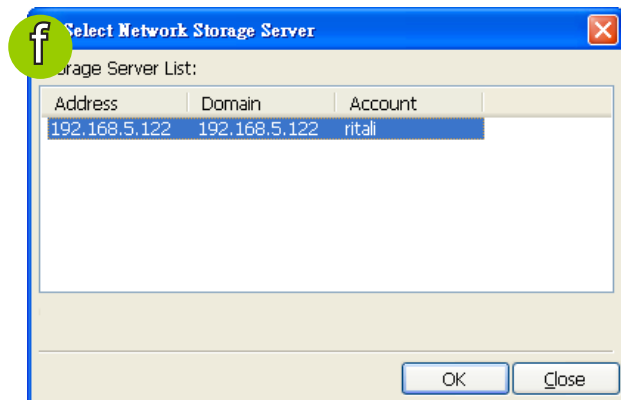
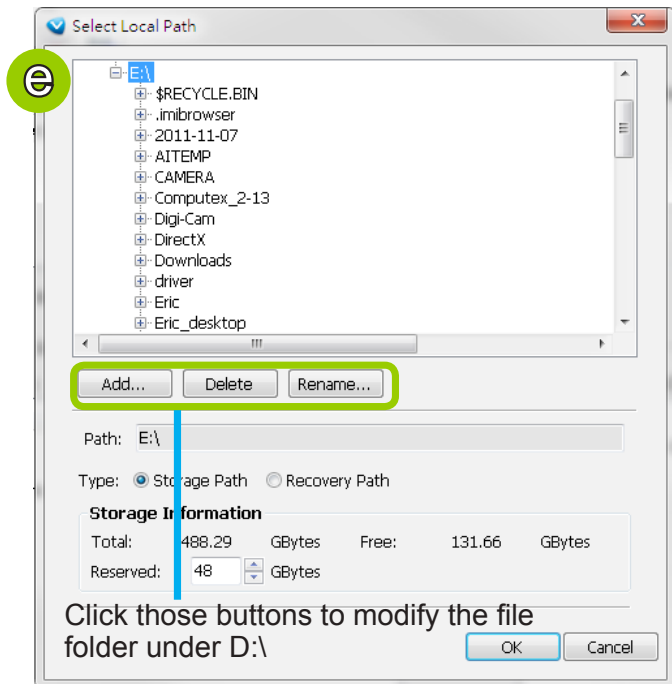

- d. The default recording path is **D:\Recording**. The total space and free space of the disk is shown on the right for reference.
- e. Add Local Path: Click  to add another recording path on your local computer. A Select Path dialog will pop up as shown below. When all settings are complete, click **OK** to enable the settings, or click **Cancel** to discard the settings. The default reserved space is 10% of the disk volume.
- f. Add Network Path: Click  to add a networked storage for recorded data. Please refer to page 164 for detailed information about how to add a new network storage server. Then double-click the **Path** to assign a specific folder as a new recording path.



Note that the reserved space is the comparatively small amount of storage space saved for data transaction during recording cycles. The reserved space is not the storage space configured for video recording.



- g. To modify the settings of a path, select the path from the list, then click  **Change settings** to modify.
- h. To delete a path, select the path from the list and click  **Delete path**. A warning dialog box will pop up as shown below.

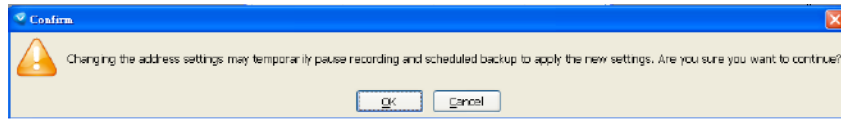

- i. By default, all devices are assigned to the **Default Recording Group** in the window on the right. You can select device(s) from the list and click **<-** to delete device(s) (or **right-click** the device under DefaultGroup tree to delete it). Note that a **Delete Camera** dialog box will pop up. Click **Yes** to delete the device along with the recorded data; click **No** to delete the device but retain the recorded data; click **Cancel** to cancel the delete action. Please note that only those designated devices can record videos.
- j. Click **->** to add devices to the **DefaultGroup**.

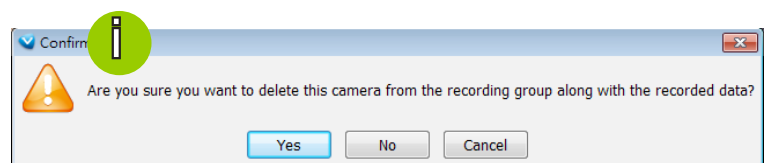
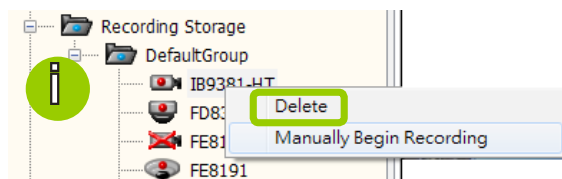
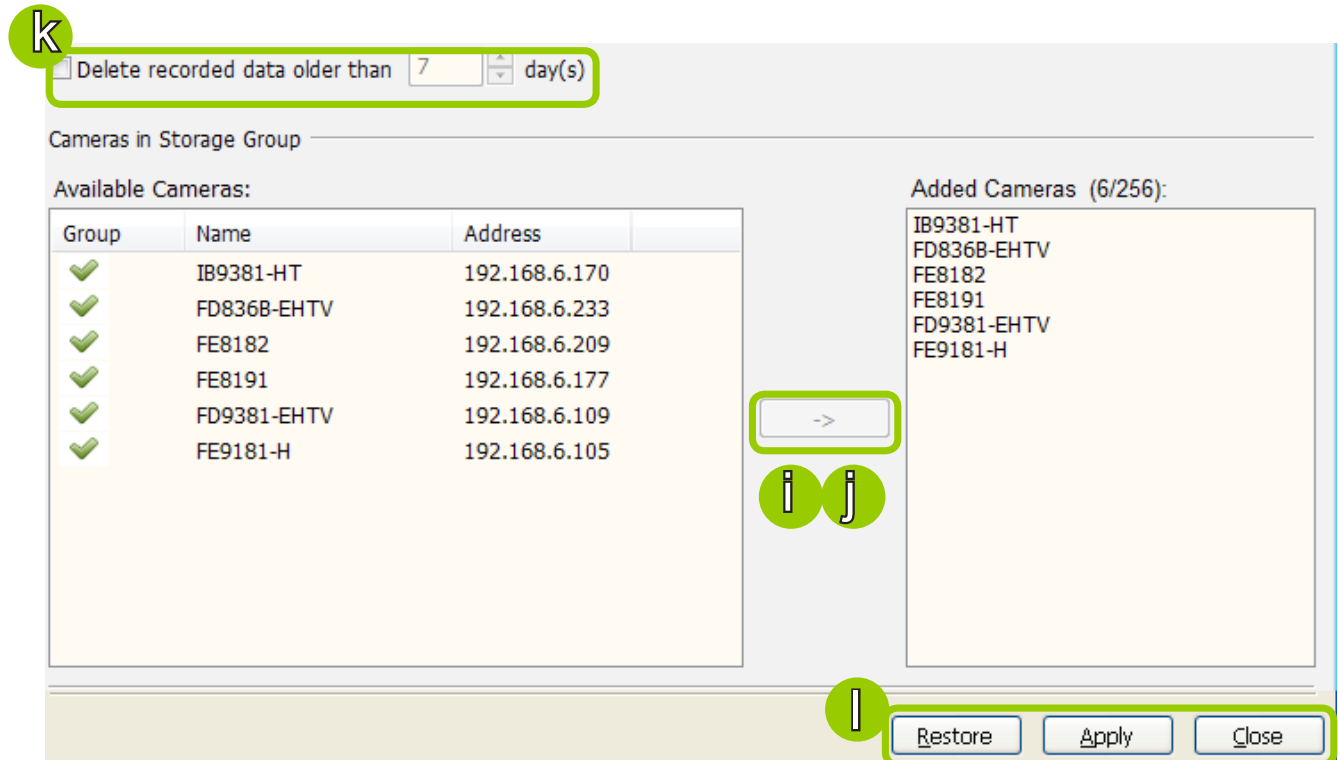

- k. Delete recorded data older than the duration: If you only want to retain recorded data for a duration, check this item and enter a number of day(s). In addition, since VAST Server will do "cyclic recording" automatically, the oldest file will be overwritten by the latest one when the maximum capacity is reached.
- l. When completed, click **Apply** to confirm and save your settings. If you want to cancel all of your editing, click **Restore** to return to the previous settings or click **close** to discard the settings.



### Add New Recording Group(s)

If you want to add a new recording group, click  **Add** to give a name to the new recording group, which will be displayed on the drop-down list.

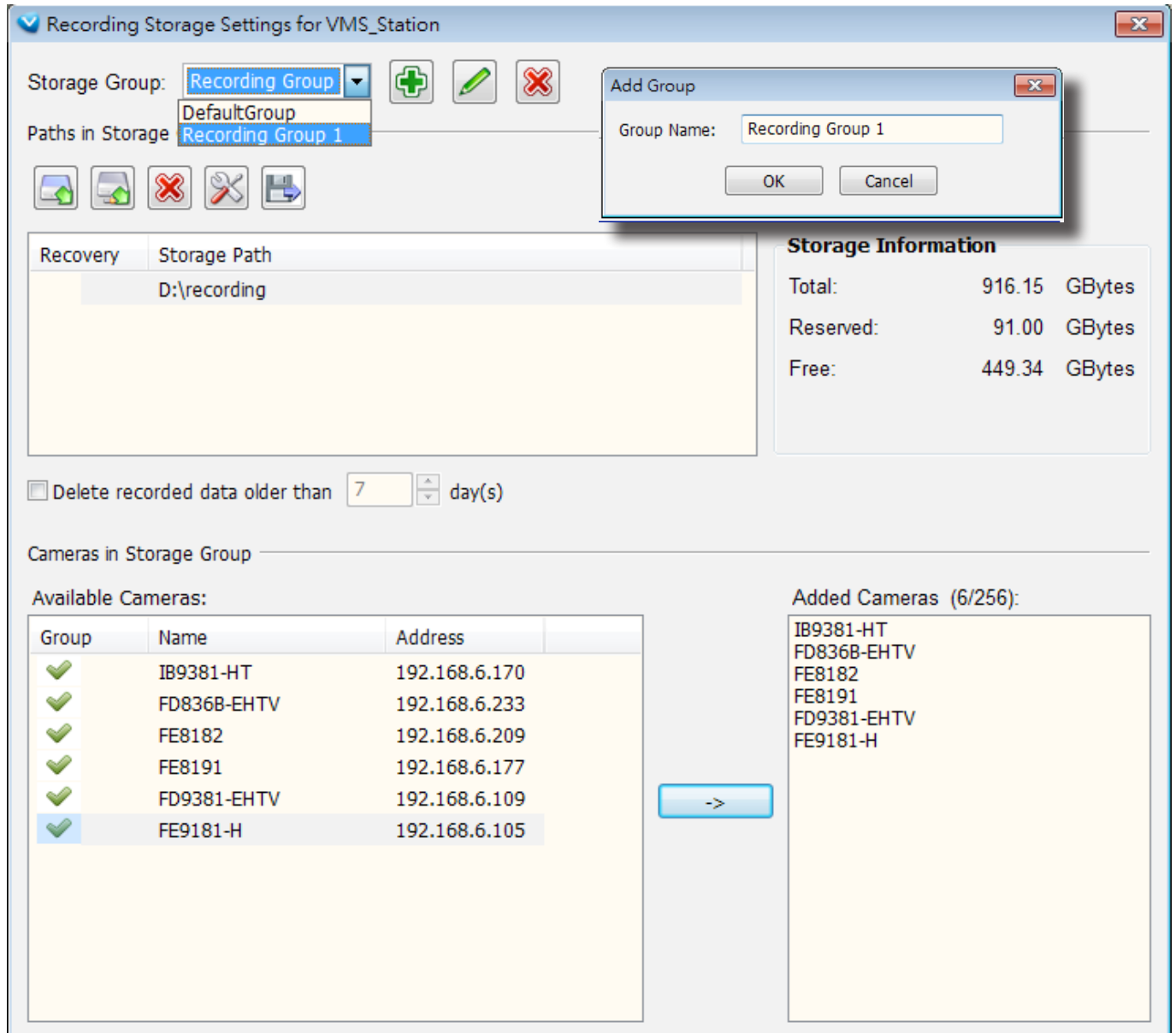
The following is an example of recording group list.



**Recording Storage Settings for VMS\_Station**

Storage Group: **Recording Group**   

Paths in Storage: **Recording Group 1**

**Add Group** dialog: Group Name: **Recording Group 1** [OK] [Cancel]

Recovery	Storage Path
	D:\recording

**Storage Information**

Total: 916.15 GBytes  
 Reserved: 91.00 GBytes  
 Free: 449.34 GBytes

Delete recorded data older than **7** day(s)

Cameras in Storage Group

Available Cameras:

Group	Name	Address
✓	IB9381-HT	192.168.6.170
✓	FD836B-EHTV	192.168.6.233
✓	FE8182	192.168.6.209
✓	FE8191	192.168.6.177
✓	FD9381-EHTV	192.168.6.109
✓	FE9181-H	192.168.6.105

Added Cameras (6/256):

- IB9381-HT
- FD836B-EHTV
- FE8182
- FE8191
- FD9381-EHTV
- FE9181-H

->



Please refer to the following limits when you set up recording group(s):

- The maximum number of devices in a recording group is 64-CH. Please refer to the system requirements of the software.
- One recording group can be assigned with several recording paths and perform cyclic recording; while one recording path should only be assigned to one recording group.

## Multiple Stream Recording

Since software revision 1.12, a camera's stream can be recorded to different storage paths, e.g., the server's internal storage and a Network Attached Storage. If hardware should fail (such as H.D.D. failure) on the VAST server, video can still be retrieved from other storage devices. This feature provides fault-tolerant redundancy for stream recording.

### Functional Requirements:

1. Each camera can be configured into multiple Recording Storage Groups, and has individual configurations in each storage group.
2. Separate recording schedules can be configured for each camera in different storage groups.
3. Schedule Backup Settings:

As shown below, when configuring a Schedule Backup, each camera in different storage groups will be listed as individual entries. You can select to back up only one of the recording streams.

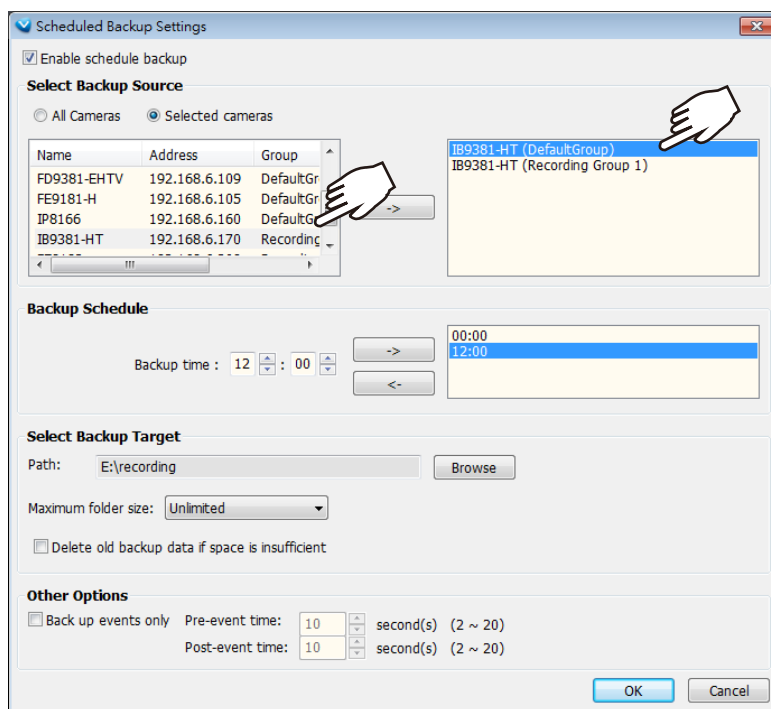

4. By default, every camera is recruited into the Default Storage Group. You can select a camera from the device tree, right-click to select **Camera Management > Update camera**.

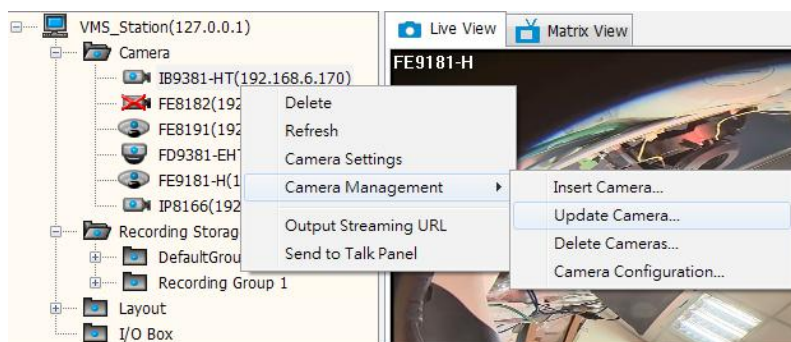

You can configure different video streams for different storage groups.

In here, you can configure the recording parameters for different storage groups. Note that you should only enable **Seamless Recording** or **Active Adaptive Stream** in one of the storage group. Applying these two functions on multiple streams can over-stress the camera.

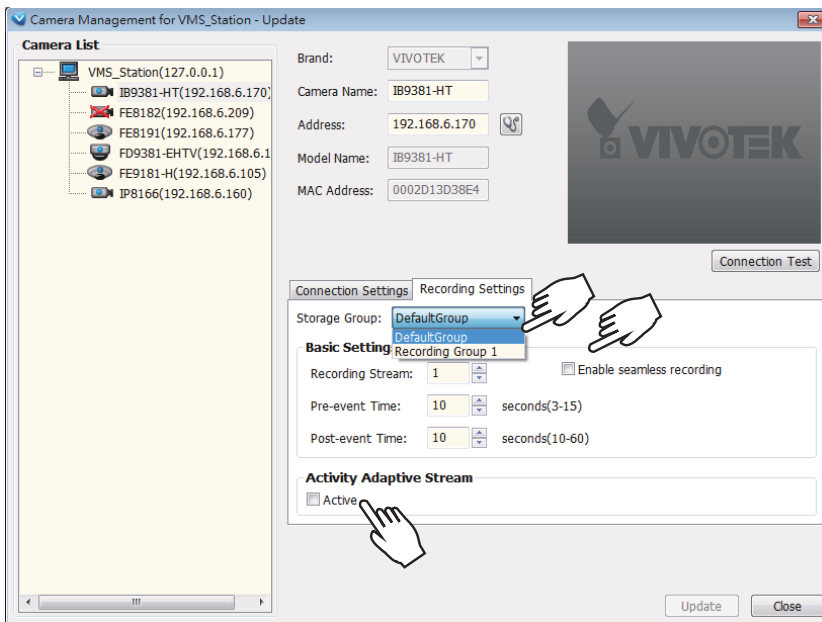

- When performing Instant Replay or Instant Playback, the system will poll the first available storage group only. If video is not available in the first storage group, playback will fail.

Note that Multiple Stream Recording is not supported when access is made via a web console. From a web console, playback displays the stream that last joined the recording storage group.

When the stream recording takes place on any of the camera's streams, the red indicator will light on on the camera's view cell.

## How to Edit Recording Schedules

After editing recording storage settings, you can begin to edit recording schedules for the devices in a recording group. By default, all devices are assigned to the default recording schedule (Please refer to the default time frame settings on page 145). Therefore, once you insert a device to the station, the VAST Server will begin to record live video according to the default recording schedule. You can also manually remove a device from the default recording schedule. Please note that **you cannot assign recording schedules to those devices which have been deleted from a recording group.**

The following is an illustration of a set of recording schedules, which are composed of several time frames. Each time frame has its own time segments, period of time, repeat interval, and recording mode. You can create different recording schedules with simple or complex time frames based on your needs.

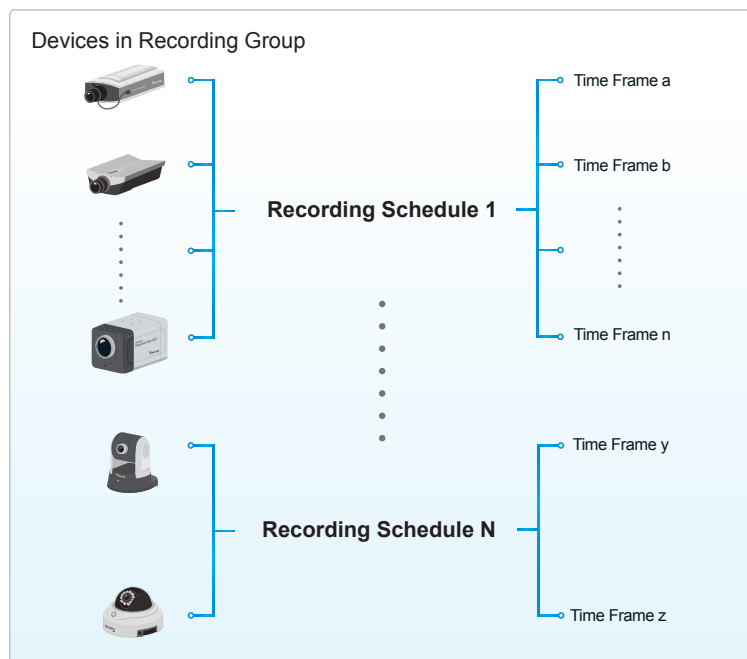

In addition, you can arrange the priority of each time frame according to its importance. The recording schedule with the highest priority will be applied first. This capability is very useful because you can specify a new time frame with the highest priority temporarily without modifying the other time frames.

Features of the recording schedules:

- Each device can be assigned to only one recording schedule.
- Each recording schedule may contain many time frames.
- Each time frame has its own repeat frequency and recording mode.

To save time editing recording schedules and time-frames, we also provide a useful **template** function to save your time on schedules/time-frames settings. That is, you can save a specified schedule and download it as a template for future use or upload a well-arranged schedule template designed by others.

Please note that after you save the recording settings in the server, the recording schedule will begin automatically according to your settings.

## Edit Schedule List

Please follow the steps below to set up the recording schedules:

- a. Select the target station from the hierarchical management tree.
- b. Click **Configuration > Station Settings > Recording Schedule Settings** on the menu bar (or **right-click** the station and select **Station Settings > Recording Schedule Settings**).

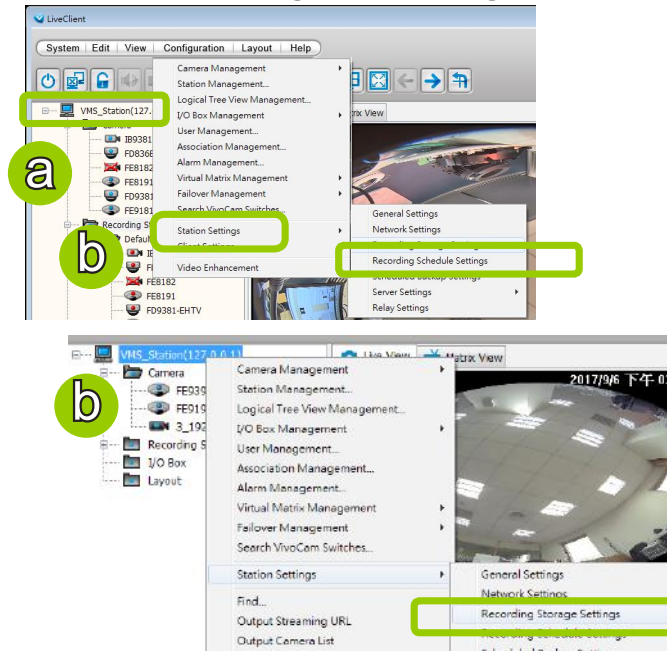

- c. The **Recording Schedule Settings** window will pop up. By default, all cameras under the station are assigned to **Default Schedule**, **Default Time Frame**, and **Default Camera List**.

### Add Schedules

- d. To add a new recording schedule, click **Add** to enter a name in the Schedule Name dialog box for the new schedule. Click **OK** to confirm the settings or **Cancel** to discard the settings. The new recording schedule will be displayed on the schedule drop-down list.

### Rename Schedules

- e. To rename an existing schedule, select the schedule from the schedule drop-down list and click **Rename**. A Schedule Name dialog will pop up for you to fill in a name for the new schedule. Click **OK** to confirm the settings or **Cancel** to discard the settings. The new recording schedule will be displayed on the schedule drop-down list.

### Delete Schedules

- f. To delete an existing schedule, select the schedule from the schedule drop-down list and click **Delete**. A Remove Schedule dialog box will pop up. Click **OK** to confirm or **Cancel** to discard the settings.

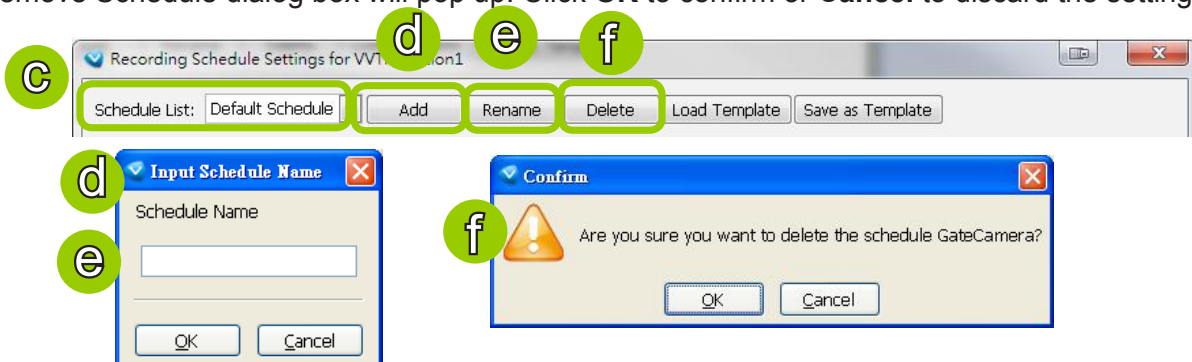

## Load/Save Schedule Templates

- g. If you have a schedule template with time frame settings, you can upload it to simplify the editing of the schedule. Click **Load Template**, and a **Load File** dialog box will pop up. Select the template file and click **Open** to load.
- h. If you want to save a schedule as a template for future use, select the schedule from the schedule drop-down list and click **Save as Template**. A **Save File** dialog box will pop up for you to save the template file.

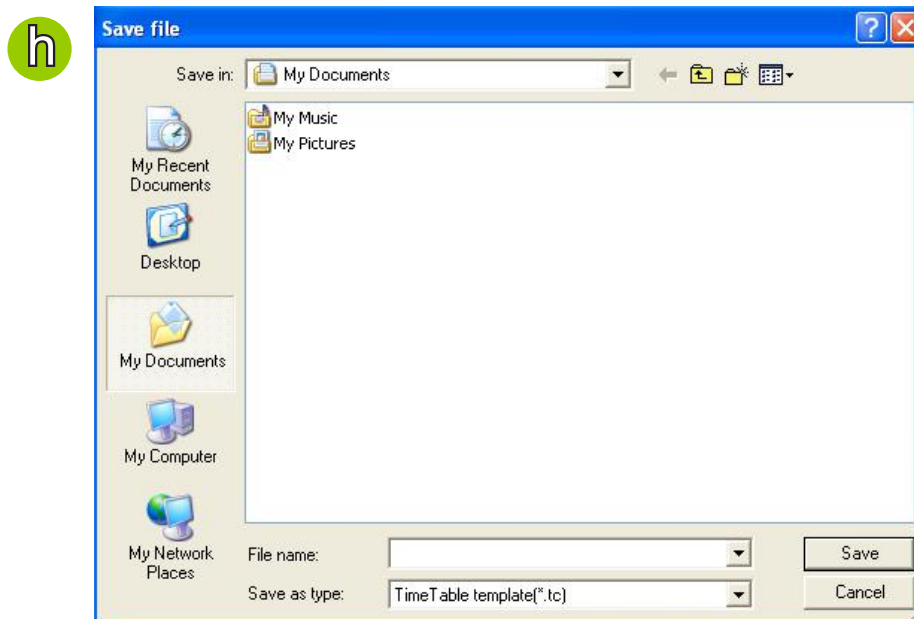
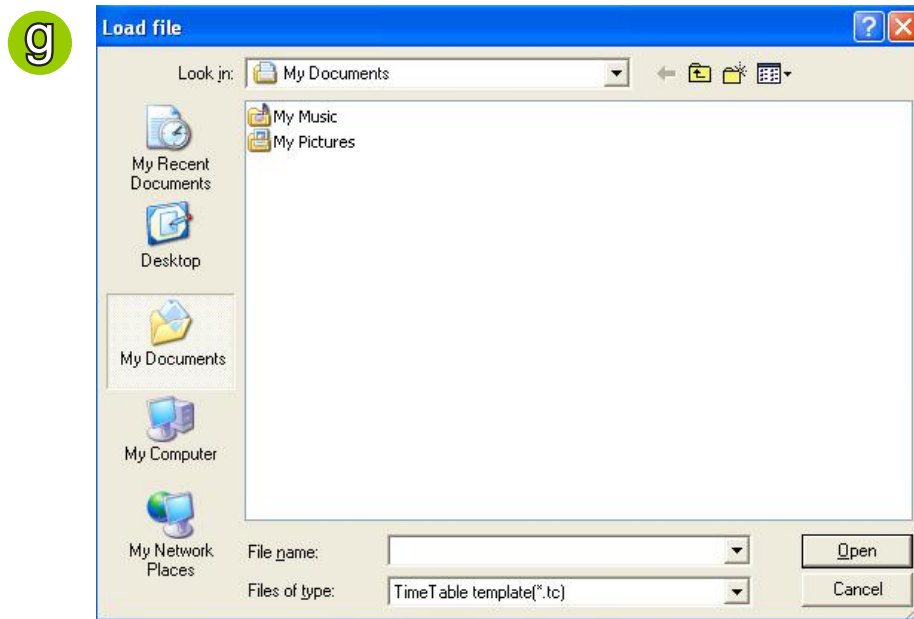
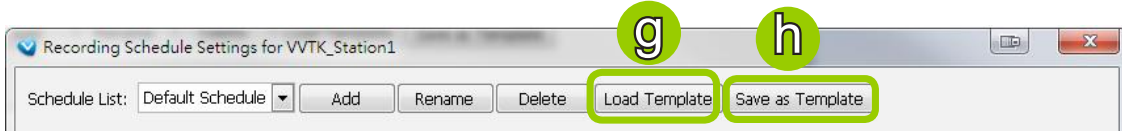

## Edit Camera List

Please follow the steps below to assign a device to a recording schedule:

- Select a recording schedule on the schedule drop-down list.
- By default, all devices under the station are assigned to the **Default Schedule**.
- Click << to remove devices from the **Default Schedule**. Click >> to add devices to the **Default Schedule**.
- Click **Apply** to confirm or **Close** to discard the settings.

**Recording Schedule Settings for VVTK\_Station1**

Schedule List: **Default Schedule** [Add] [Rename] [Delete] [Load Template] [Save as Template]

**Time Frame List**

Time Frame	Rule
Always	Weekly Setting (Day-based)

[Add] [Edit] [Delete] [Up] [Down]

**Recording Settings**

Recording Mode: **Event**

**Triggers**

Motion  PIR  Tampering  
 P-PTZ  Line Crossing  Field Detection

**Digital Input**

Traditional Recording  
 Trigger State  Normal State  
 Recording from DI activated to DI normal  
 Recording from DI normal to DI activated

**Camera List**

Name	Address	Group	Schedule
Mega-Pixel Ne...	192.168.4.121	DefaultGroup	Yes
Wireless camera	192.168.6.143	DefaultGroup	Yes
Mega-Pixel Ne...	192.168.6.127	DefaultGroup	Yes
Mega-Pixel Ne...	192.168.6.217	DefaultGroup	Yes
Mega-Pixel Ne...	192.168.6.101	DefaultGroup	Yes

[<] [ ] [>]

Mega-Pixel Network Camera  
Wireless camera  
Mega-Pixel Network Camera  
Mega-Pixel Network Camera  
Mega-Pixel Network Camera

[>>]

[Apply] [Close]



If you add a Network Device that does not belong to any Recording Group, a warning dialog will pop up as shown below. For more information about how to set up Recording Group(s), please refer to Recording Group Settings on page 135.

**Camera List**

Name	Address	Group	Scheduled
1_PZ7131	192.168.3.247	DefaultGroup	Yes
2_IP8161	172.16.200.40	DefaultGroup	No

1\_PZ7131

**Error**

The camera is not in recording group.

[OK]

[Apply] [Close]



## Edit Time Frame List

Default Time Frame: Weekly (Day-based), Mon.~Sun., 24-hour, continuous recording

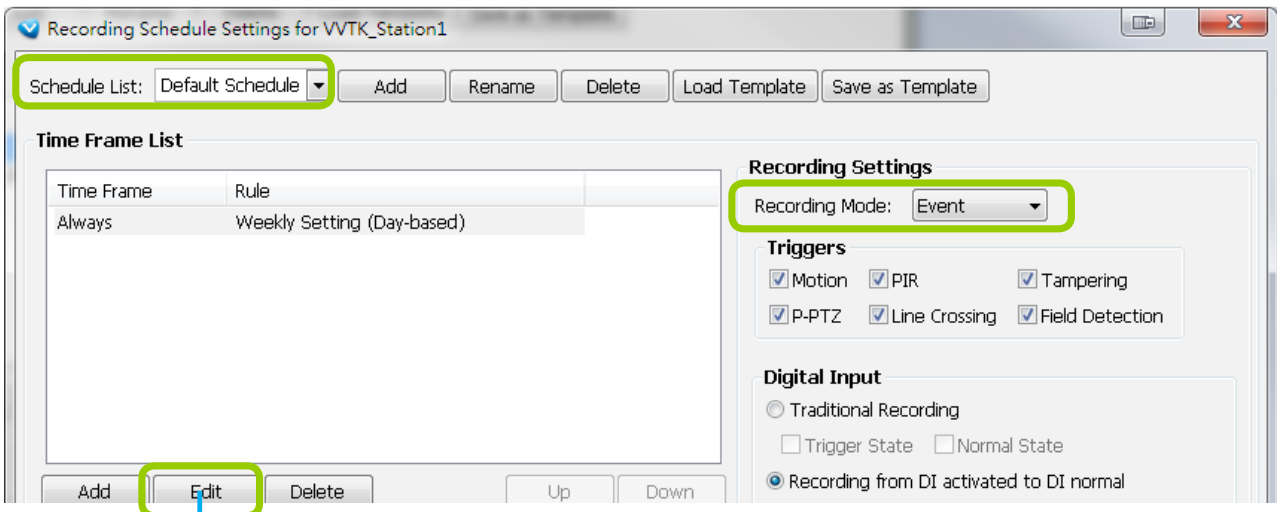

Click **Edit** to open the Default Time Frame settings page as shown below.

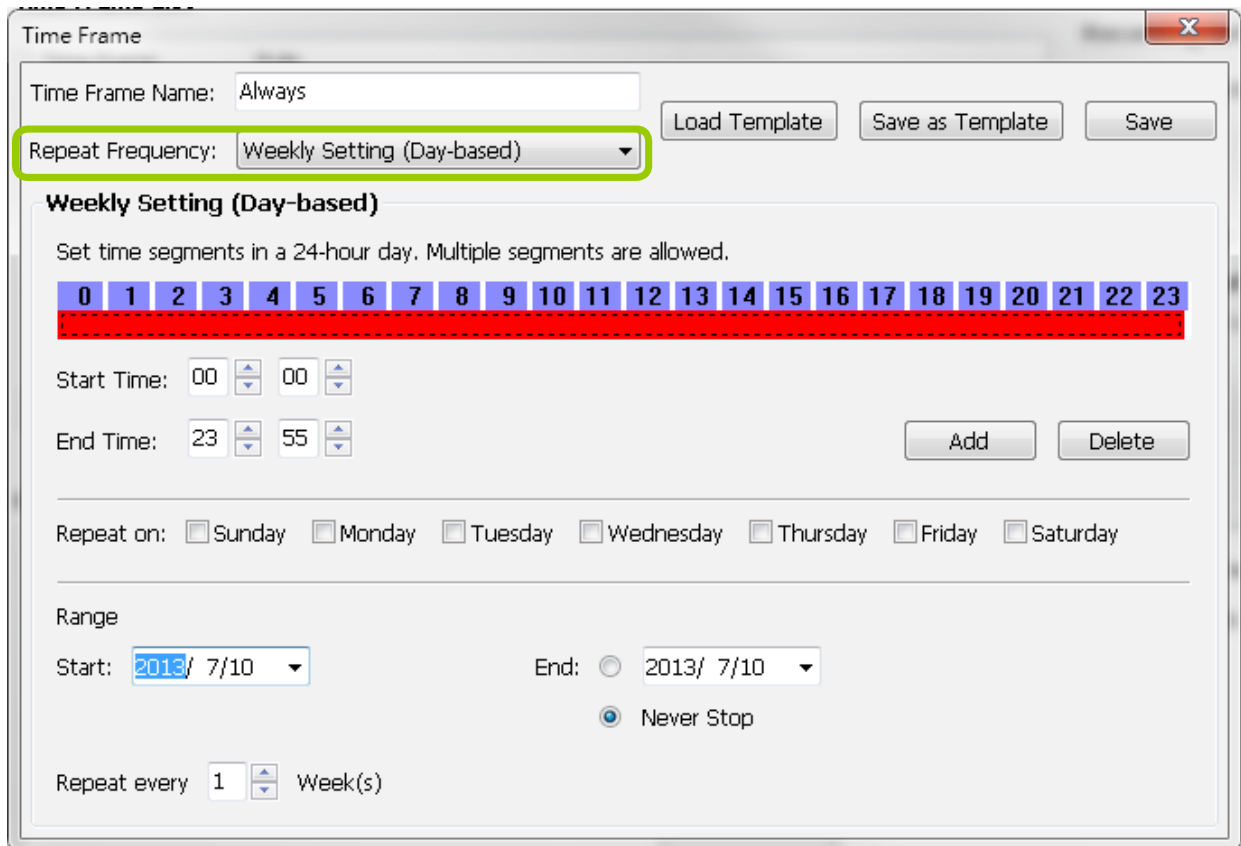

## Add New Time Frames

Please follow the steps below to add new time frames to a schedule:

- a. Select a recording schedule from the drop-down list.
- b. Click **Add** to open the **Time Frame Settings** window.

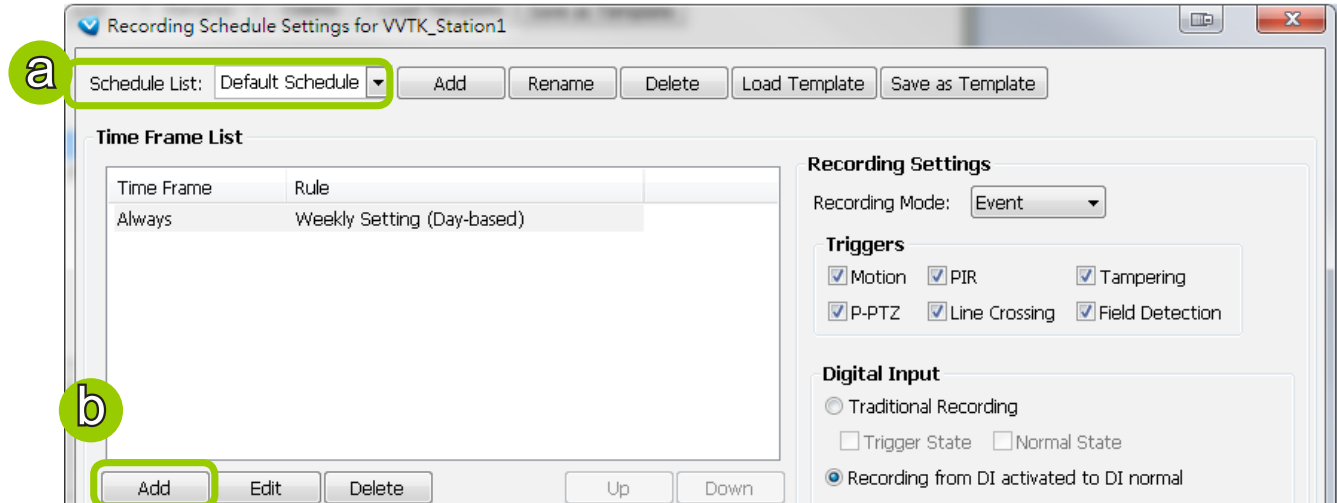

- c. Enter a name for the new time frame.
- d. If you have a time-frame template, you can upload it to simplify the editing of the schedule. Click **Load Template** and the **Load File** dialog box will pop up. Select the template file to load.
- e. To edit the new time frame, select a **Repeat Frequency** from the drop-down list and edit the time segments, applicable days, applicable period of time, and repeat time interval. For the detailed settings of each repeat frequency, please refer to **The Concept of Repeat Frequency** on page 149.
- f. When completed, click **Save** to enable the settings.
- g. If you want to save this time frame as a template for future use, click **Save as Template**. A **Save file** dialog will pop up for you to save the template.

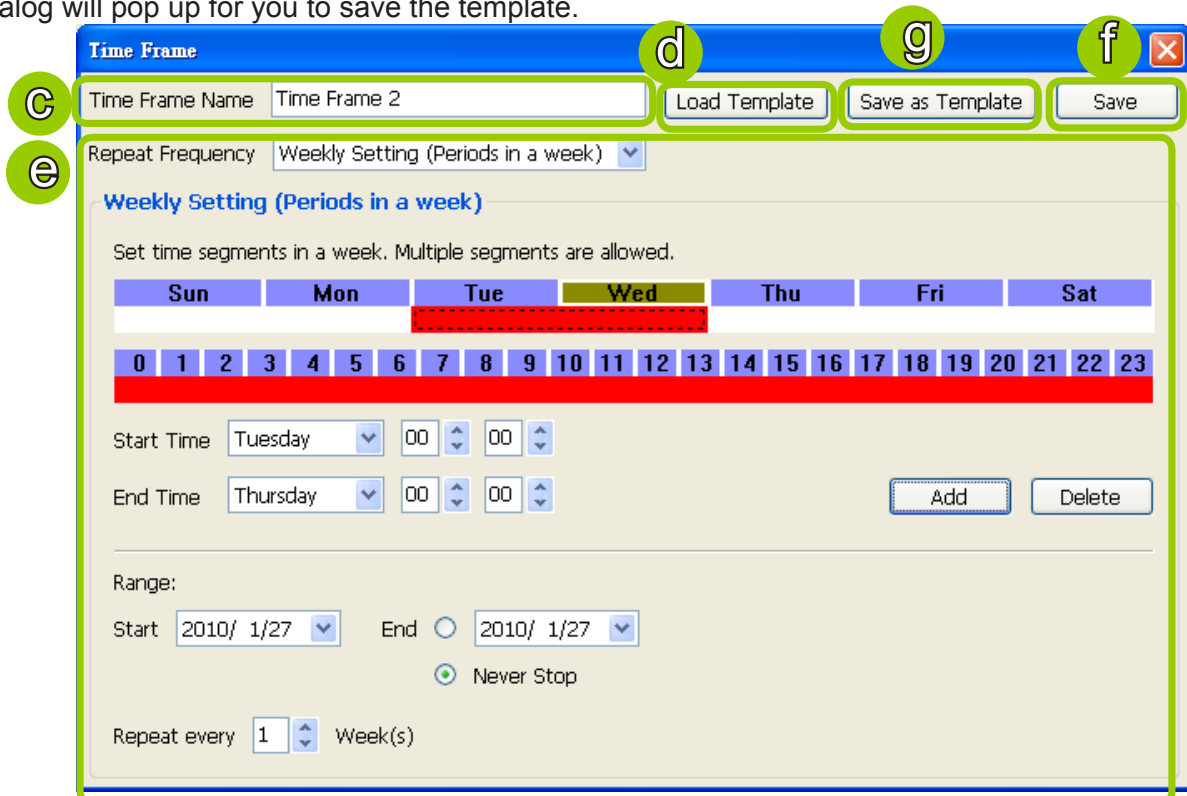

- h. If you want to add additional time frames to the schedule, repeat the steps above.
- i. Close the window when you finish the time frame settings.
- j. Back to the Recording Schedule Settings window, the new time frame will be displayed on the Time Frame List.
- k. If you want to edit an existing time frame, select it from the Time Frame List and click **Edit** to set up.
- l. If you want to delete an existing time frame, select it from the Time Frame List and click **Delete**.
- m. If you want to change the priority of a time frame, select it from the Time Frame List and click **Up** or **Down** to shift its position. The time frame on the top of the list has the highest priority.

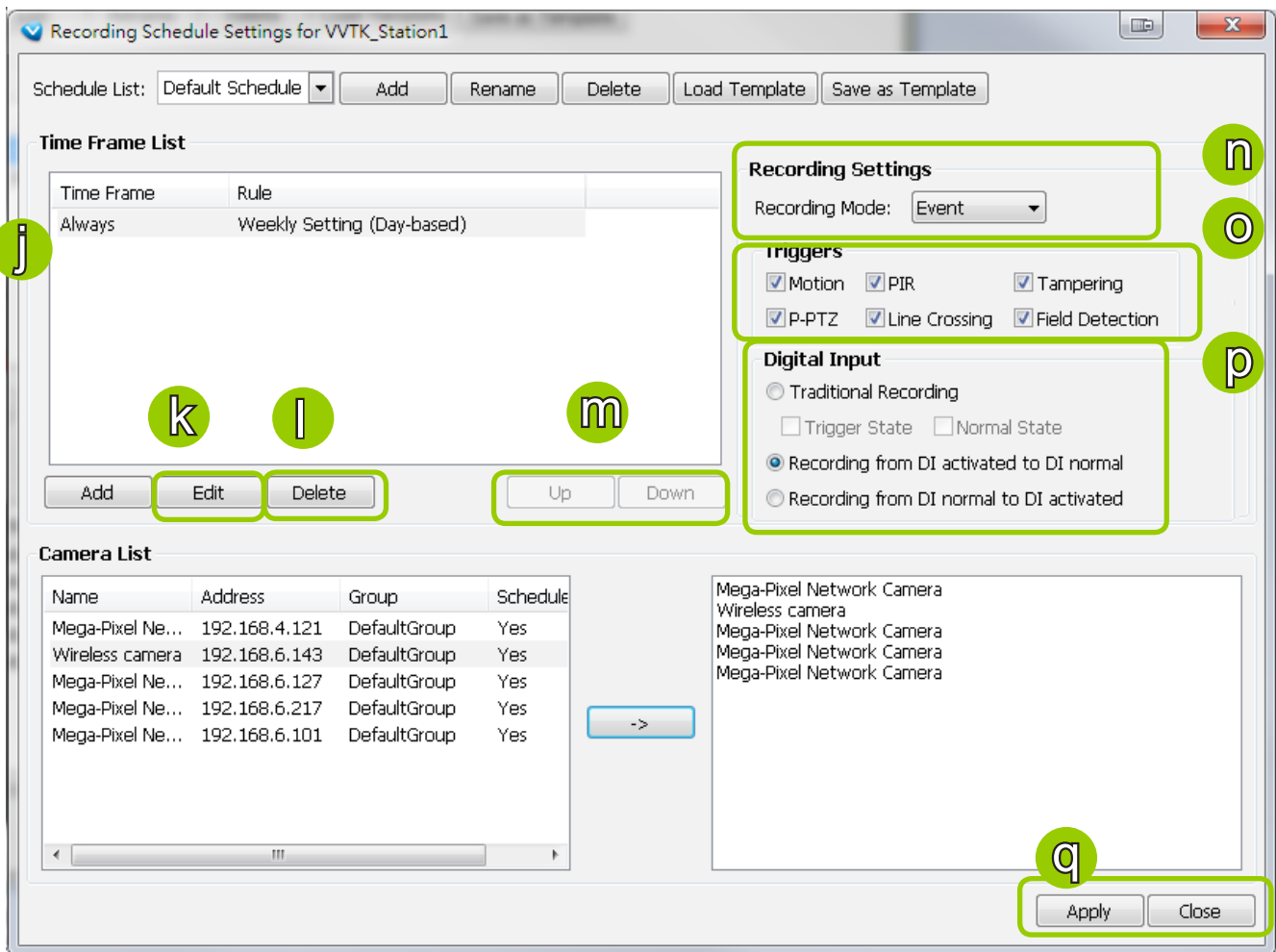

## Recording Settings

- n. Select one of the following Recording Modes for the time frame:
  - **None**: No recording action.
  - **Continuous**: 24-hours continuous recording. If you want to enable Activity Adaptive Streaming, please refer to page 138 for detailed illustration.
  - **Event**: The server will start to record only when an event is triggered. The recording time length depends on the settings in Recording Storage Settings. The default time length is 20 seconds (10s pre-event time plus 10s post-event time). Please refer to page 137 for more information. For more information about event categories, please refer to page 257 for detailed information.
- o. Select Trigger Source(s): Motion Detection, Line Crossing, Field Detection, PIR, Tampering Detection, and P-PTZ (Auto Tracking).
- p. Digital Input: See next page for more information.

The Digital Input signal triggers can be configured as follows:

1. Traditional Recording: can be triggered when the DI enters the Trigger State or the Normal State. If thus configured, the recording task will end when the post-event recording time is reached.
2. The recording starts when DI is triggered, and will end when the DI signal returns to Normal.
3. The recording starts when DI is Normal, and will end when the DI signal returns to Triggered.
4. The DI-triggered recordings also include the appended lengths of pre- and post-event recordings (default is 10 seconds). Therefore, the length of DI-triggered recording is as follows:

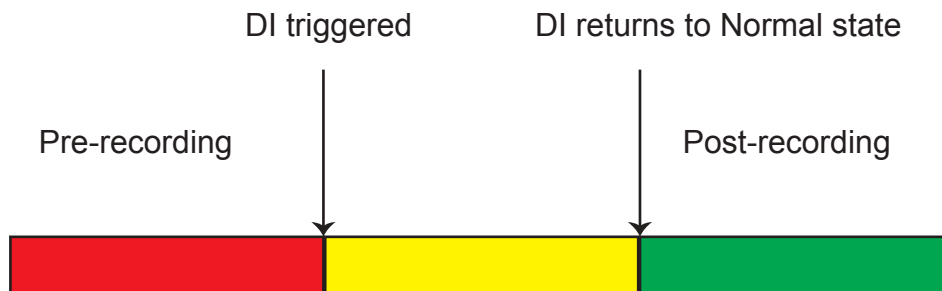

An example for the configuration can be: the recording starts when a door is opened (DI triggered), and the recording stops when the door is closed (DI returns to normal).



When connected, a camera's Digital input signal is automatically detected as pulled-high or pulled-low. Users should then designate the current state as Normal or Trigger. The configuration page is found in **Configuration > Application > Digital Input** on a web console.

#### Applications > Digital input

**Digital input**

Normal status:  High  Low

Current status: **High**

- q. Click **Apply** to confirm the settings. Then close the window when you finish the recording schedule settings.



The following diagrams show the frame rate variation of two recording modes:

1. Continuous recording + Activity adaptive recording (helps save bandwidth and storage)

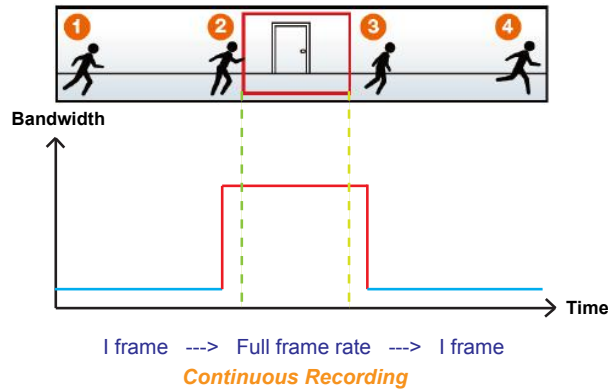

2. Event recording

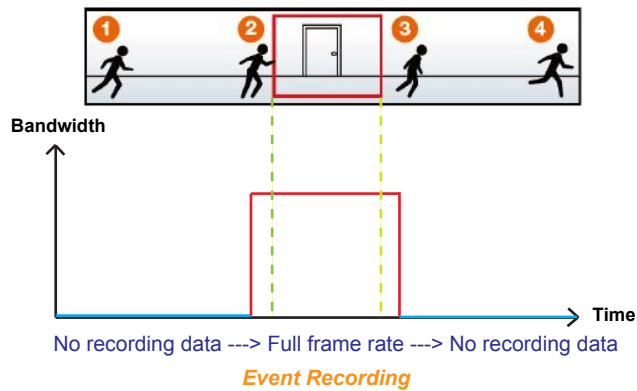

## The Concept of Repeat Frequency

VAST offers the following types of repeat frequency. The definition of each type is listed in the following table:

Repeat Frequency	Discription
<b>Daily Setting</b>	<ul style="list-style-type: none"> <li>Specify arbitrary time segments within a day,</li> <li>Repeat the segments every N days in the specified period of time.</li> </ul>
<b>Weekly Setting (Day-based) (Default Time Frame)</b>	<ul style="list-style-type: none"> <li>Specify arbitrary time segments within a day,</li> <li>Apply only on selected days of a week,</li> <li>Repeat the segments every N weeks during the specified period of time.</li> </ul>
<b>Weekly Setting (Periods in a week)</b>	<ul style="list-style-type: none"> <li>Specify arbitrary time segments within a week,</li> <li>Repeat the segments every N weeks during the specified period of time.</li> </ul>
<b>Monthly Setting (Day-based)</b>	<ul style="list-style-type: none"> <li>Specify arbitrary time segments within a day,</li> <li>Apply only on selected days of a month,</li> <li>Repeat the segments every N months during the specified period of time.</li> </ul>
<b>Yearly Setting (Day-based)</b>	<ul style="list-style-type: none"> <li>Specify arbitrary time segments within a day,</li> <li>Apply only on selected days of a year,</li> <li>Repeat the segments every N years during the specified period of time.</li> </ul>

## Repeat Frequency: Daily Setting

To set up daily repeat frequency, please configure the following items: Daily time segments, applicable period of time, and repeat time interval.

**Daily time segments**  
\*You can drag the daily timeline bar for more than one time segment per day.

**Applicable period of time**

**Repeat time interval**

### Set up daily time segments

You can specify several time segments within a day. The numbers 0~23 on the **hourly timeline control bar** (the purple rectangles) represent the 24 hours in a day.

There are two ways to define time segments: one is to use the computer mouse to manipulate the timeline control bars; the other is to fill in the precise start and end time values in the corresponding fields.

#### **Add time segments: Choose either step 1 or step 2 to set up**

1. Use the mouse to drag the timeline bars:
  - a. **Left-click** the **daily timeline control bar** (the purple rectangles) and drag the mouse.
  - b. The corresponding time segment will also appear in the Start Time and End Time fields. Click **Add**, then the red timeline bars representing new time segments will appear as shown below. You can drag multiple time segments within a day.

In the following illustration, the yellow arrows show the dragging direction of the mouse. You can drag from left to right or the opposite.

2. Fill in the precise Start Time and End Time:

- a. Directly enter the value in the Start Time and End Time fields, then click **Add**.
- b. The corresponding red timeline bar will automatically appear as shown below.

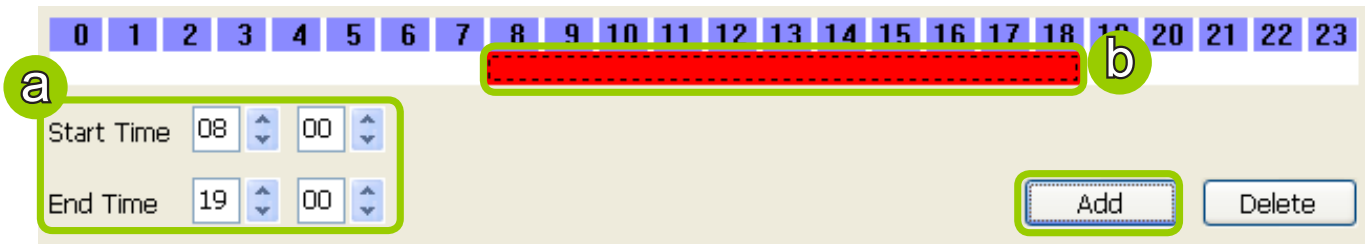

**Delete time segments:** Choose either step 1 or step 2 to set up

1. Use the mouse to erase the timeline bar: **Right-click** on an existing red timeline bar and drag the mouse. A green timeline bar representing the deleted part of the time segment will erase the red bar as shown below.

In the following illustration, the green arrows show the dragging direction of the mouse. You can drag it from left to right or the opposite.

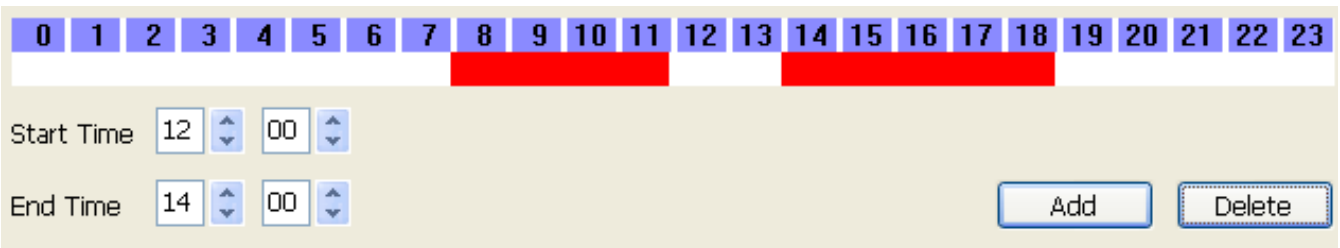
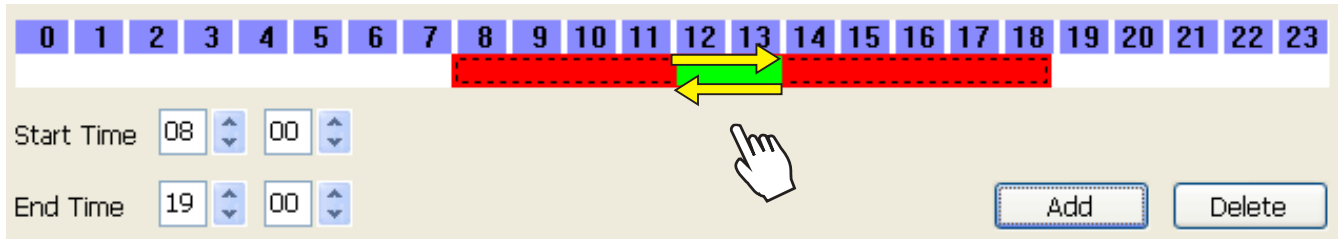

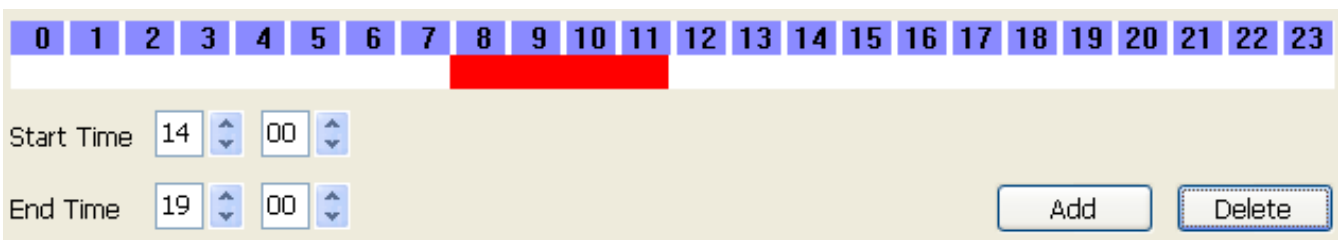
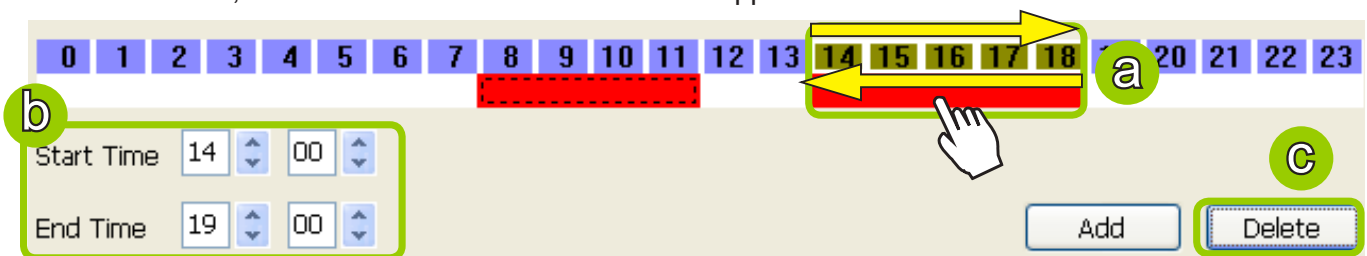

2. Use the delete button to remove the entire timeline bar:

- a. Click an existing red timeline bar or **left-click** the **daily timeline control bar** (the purple rectangles) and drag the mouse.
- b. The corresponding time segment will appear in the Start Time and End Time fields.
- c. Click **Delete**, and the selected timeline bar will disappear.



### Set up applicable period of time

For repeat frequencies, you can set up the applicable date and period of time for the time frame.

- a. Specify the start date and time in the **Start** field. A calendar date selector will appear when you click on the drop-down list of **date**. Click  or  to select the month, then pick a desired day in the calendar.
- b. Specify the end date and time in the **End** field if you have an end time for applying this time frame. If you do not have a terminating time for this time frame, select **Never Stop**.

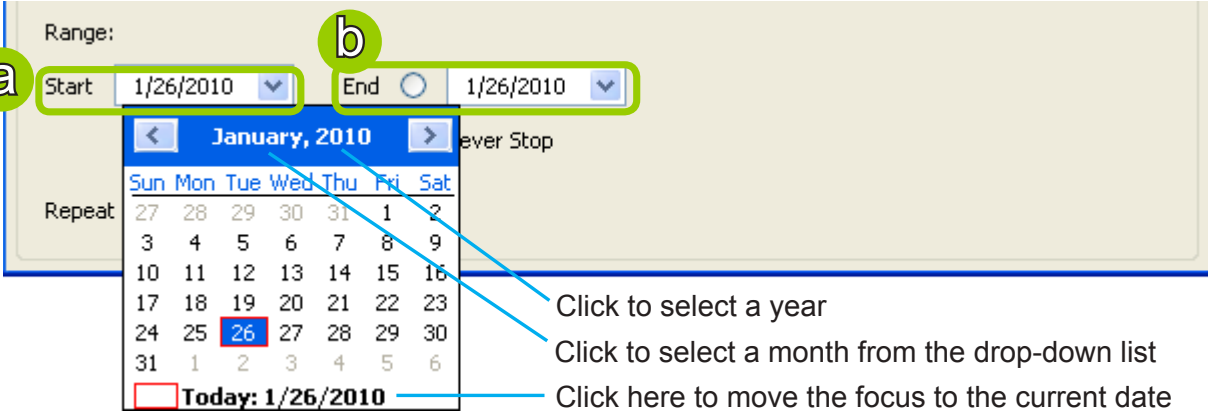

Range:

Start  End   Never Stop

Repeat

Sun	Mon	Tue	Wed	Thu	Fri	Sat
27	28	29	30	31	1	2
3	4	5	6	7	8	9
10	11	12	13	14	15	16
17	18	19	20	21	22	23
24	25	26	27	28	29	30
31	1	2	3	4	5	6

Today: 1/26/2010

Click to select a year

Click to select a month from the drop-down list

Click here to move the focus to the current date

### Set up repeat time interval

The repeat time intervals is "every N day(s)" as shown below. Repeat every 1 day means the time frame would apply for every day within the period of time.

Repeat every    Day(s)



## Repeat Frequency: Weekly Setting (Day-based)

To set up Weekly (Day-based) repeat frequency, please configure the following items: Daily time segments, applicable days within a week, applicable period of time, and repeat time interval.

**Time Frame**

Time Frame Name  Load Template Save as Template Save

Repeat Frequency Weekly Setting (Day-based)

**Weekly Setting (Day-based)**

Set time segments in a 24-hour day. Multiple segments are allowed.

**Daily timeline control bar (24h)**

0 1 2 3 4 5 6 7 8 9 10 11 12 13 14 15 16 17 18 19 20 21 22 23

Start Time 00 00

End Time 00 00 Add Delete

Repeat on  Sunday  Monday  Tuesday  Wednesday  Thursday  Friday  Saturday

Range:

Start 2010/ 1/28 End  2010/ 1/28  Never Stop

Repeat every 1 Week(s)

**Daily Time segments**  
\*You can drag more than one time segment per day.

**Applicable days within a week**

**Applicable period of time**

**Repeat time interval**

### Set up daily time segments

Please refer to page 150 for detailed instructions.

### Set up applicable days within a week

For repeat frequency--"Weekly (day based)", you can apply the time segments only on selected days of the week.

Repeat on  Sunday  Monday  Tuesday  Wednesday  Thursday  Friday  Saturday

### Set up applicable period of time

Please refer to page 152 for detailed instructions.

### Set up repeat time interval

The repeat time intervals is "every N week(s)" as shown below. Repeat every 1 week means the time frame would apply for every week within the period of time.

Repeat every  Week(s)

### Repeat Frequency: Weekly Setting (Periods in a week)

To set up Weekly (Periods in a week) repeat frequency, please configure the following items: Time segments within a week, applicable period of time, and repeat time interval.

### Set up time segments within a week

You can specify several time segments within a week. The **weekly timeline control bar** represents the 7 days of a week, and the **daily timeline control bar** represents the 24 hours in a day. The daily timeline control bar is only valid when one of the days on the weekly timeline control bar has been selected.

There are two ways to set up time segments: one is to use the computer mouse to draw the timeline control bars; the other is to fill in the precise start and end time value in the corresponding fields.

#### **Add time segments:** Choose either step 1 or step 2 to set up

1. Use the mouse to drag the timeline bars:
  - a. Click on a day on the **weekly timeline control bar**. The selected bar will turn green.
  - b. **Left-click** the **daily timeline control bar** and drag the mouse.
  - c. The corresponding time segment will also appear in the Start Time and End Time fields. Click **Add**, then the red timeline bars representing new time segments will appear as shown below. You can drag multiple time segments within a day and a week.

In the following illustration, the yellow arrows show the dragging direction of the mouse. You can drag from left to right or the opposite.

2. Fill in a precise Start Time and End Time:

- a. Directly select a day and enter the value in the Start Time and End Time fields, then click **Add**.
- b. The corresponding red timeline bars will automatically appear as shown below.

The following is an example of an extended time segment from Mon. 8:00 to Fri. 19:00.

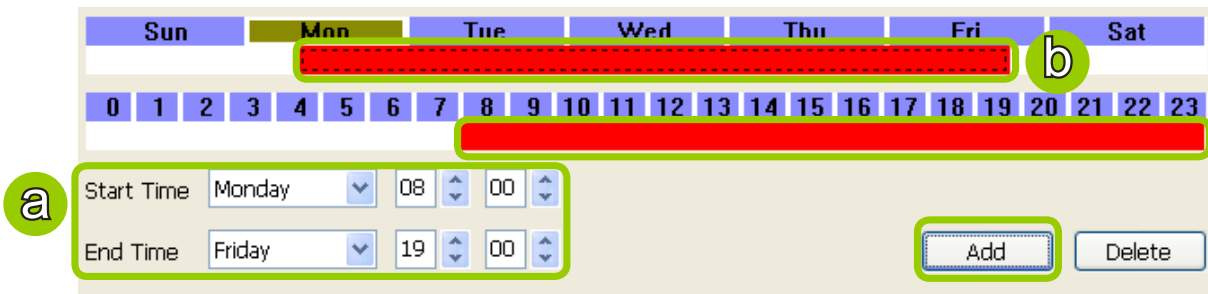

**Delete time segments:** Please refer to page 151 for detailed instructions.

**Set up applicable period of time**

Please refer to page 152 for detailed instructions.

**Set up repeat time interval**

Please refer to page 152 for detailed instructions.

### Repeat Frequency: Monthly Setting (Day-based)

To set up Monthly (Day-based) repeat frequency, please configure the following items: Daily time segments, applicable date(s) of a month/ day(s) of a week, applicable period of time, and repeat time interval.

**Time Frame**

Time Frame Name  Load Template Save as Template Save

Repeat Frequency **Monthly Setting (Day-based)**

**Monthly Setting (Day-based)**

Set time segments in a 24-hour day. Multiple segments are allowed.

**Timeline control bar (24hr)**

0 1 2 3 4 5 6 7 8 9 10 11 12 13 14 15 16 17 18 19 20 21 22 23

Start Time 00 00

End Time 00 00 Add Delete

Repeat on Date (of a month)

January 2010 Repeat on the following date(s) of a month:

Sun	Mon	Tue	Wed	Thu	Fri	Sat
					1	2
3	4	5	6	7	8	9
10	11	12	13	14	15	16
17	18	19	20	21	22	23
24	25	26	27	28	29	30
31						

Delete

Range:

Start 2010/ 1/28 End 2010/ 1/28 Never Stop

Repeat every 1 Month(s)

**Daily time segments**  
\*You can drag more than one time segment per day.

**Applicable date(s) of a month/ day(s) of a week**

**Applicable period of time**

**Repeat time interval**

### Set up daily time segments

Please refer to page 150 for detailed instructions.

### Set up applicable date(s) of a month/ day(s) of a week

For repeat frequency--"monthly (day-based)", you can apply the time segments only on selected days of a month. There are two types of repeat frequencies: Date(s) of a month and Day(s) of a week.

**Repeat by date(s) of a month:**

Select date(s) from the calendar, and it will be displayed on the right blank as shown below. The following example refers to the 1<sup>st</sup> ~ 5<sup>th</sup> day of a month.

Repeat on **Date (of a month)**

January 2010 Repeat on the following date(s) of a month:

Sun	Mon	Tue	Wed	Thu	Fri	Sat
					1	2
3	4	5	6	7	8	9
10	11	12	13	14	15	16
17	18	19	20	21	22	23
24	25	26	27	28	29	30
31						

01  
02  
03  
04  
05

Delete

**Repeat by day(s) of a week:**

Select day(s) from the calendar, and it will be displayed on the right blank as shown below. The following example refers to the 1<sup>st</sup> ~ 5<sup>th</sup> Friday of a month.

Repeat on **Day (of a week)**

January 2010 Repeat on the following day(s) of a month:

Sun	Mon	Tue	Wed	Thu	Fri	Sat
					1	2
3	4	5	6	7	8	9
10	11	12	13	14	15	16
17	18	19	20	21	22	23
24	25	26	27	28	29	30
31						

1st Friday  
2nd Friday  
3rd Friday  
4th Friday  
5th Friday

Delete

**Set up applicable period of time**

Please refer to page 152 for detailed instructions.

**Set up repeat time interval**

The repeat time intervals is "every N month(s)" as shown below. Repeat every 1 month means the time frame would apply for every month within the period of time.

Repeat every  Month(s)

### Repeat Frequency: Yearly Setting (Day-based)

To set up Yearly (Day-based) repeat frequency, please configure the following items: Daily time segments, applicable date(s) of a year/ day(s) of a week, applicable period of time, and repeat time interval.

**Time Frame**

Time Frame Name  Load Template Save as Template Save

Repeat Frequency Yearly Setting (Day-based)

**Yearly Setting (Day-based)**

Set time segments in a 24-hour day. Multiple segments are allowed.

Timeline control bar (24hr)

Start Time 00 00 End Time 00 00 Add Delete

Repeat on Date (of a year)

January 2010 Repeat on the following date(s) of a year:

Sun	Mon	Tue	Wed	Thu	Fri	Sat
					1	2
3	4	5	6	7	8	9
10	11	12	13	14	15	16
17	18	19	20	21	22	23
24	25	26	27	28	29	30
31						

Delete

Range:

Start 2010/ 1/28 End 2010/ 1/28 Never Stop

Repeat every 1 Year(s)

**Daily time segments**  
\*You can drag more than one time segment per day.

**Applicable date(s) of a year/ day(s) of a week**

**Applicable period of time**

**Repeat time interval**

### Set up daily time segments

Please refer to page 150 for detailed instructions.

### Set up applicable date(s) of a year/ day(s) of a week

For repeat frequency--"yearly (day-based)", you can apply the time segments only on selected days of a year. There are two types of repeat frequencies: Date(s) of a year and Day(s) of a week.

**Repeat by date(s) of a year:**

Select date(s) from the calendar, and it will be displayed on the right blank as shown below. The following example refers to the 1<sup>st</sup> ~ 5<sup>th</sup> day of a year.

Repeat on Date (of a year)

January 2010

Sun	Mon	Tue	Wed	Thu	Fri	Sat
					1	2
3	4	5	6	7	8	9
10	11	12	13	14	15	16
17	18	19	20	21	22	23
24	25	26	27	28	29	30
31						

Repeat on the following date(s) of a year:

01/01  
01/02  
01/03  
01/04  
01/05

Delete

**Repeat by day(s) of a week:**

Select day(s) from the calendar, and it will be displayed on the right blank as shown below. The following example refers to the January 1<sup>st</sup> ~ 5<sup>th</sup> Friday of a year.

Repeat on Day (of a week)

January 2010

Sun	Mon	Tue	Wed	Thu	Fri	Sat
					1	2
3	4	5	6	7	8	9
10	11	12	13	14	15	16
17	18	19	20	21	22	23
24	25	26	27	28	29	30
31						

Repeat on the following day(s) of a year:

January 1st Friday  
January 2nd Friday  
January 3rd Friday  
January 4th Friday  
January 5th Friday

Delete

**Set up applicable period of time**

Please refer to page 152 for detailed instructions.

**Set up repeat time interval**

The repeat time intervals is "every N year(s)" as shown below. Repeat every 1 year means the time frame would apply for every year within the period of time.

Repeat every  Year(s)

## How to Manually Begin /Stop Recording

By default, all devices are assigned to the default recording storage and default recording schedule. Therefore, once you insert a device onto the station, the VAST Server will begin to record live video according to the default recording schedule. Please refer to **How to Edit Recording Schedules** on page 141.

However, if you have changed the default schedule, you can manually click **Manually Begin Recording** to enable a device without setting up a recording schedule. Please follow the instructions below to manually begin recording.

Select the device from the hierarchical management tree under Default Group, then click **Edit > Manually Begin Recording** on the menu bar (or **right-click** the device and select **Manually Begin Recording**). The string on the menu bar will turn into **Manually Stop Recording** as shown below and the VAST Server will start to record video from the target camera. Please note that its priority will be higher than the recording schedule, so it will continue unless you click **Manually Stop Recording**. After you click **Manually Stop Recording**, the device will then follow the preset recording schedule.

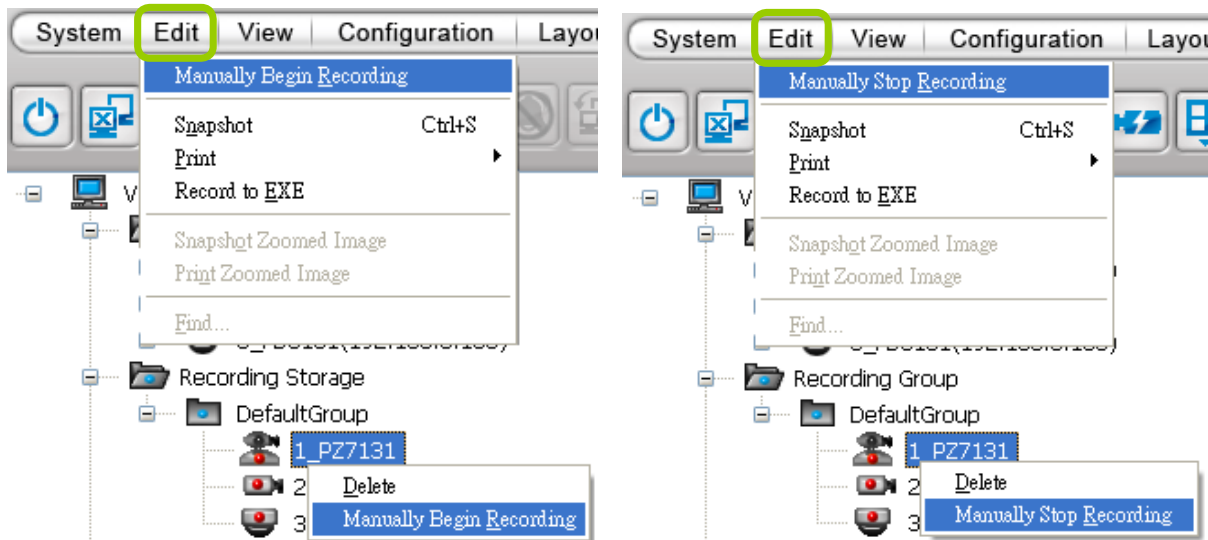



## How to Edit Scheduled Backup Settings

VAST LiveClient supports scheduled backup which allows the user to back up the recorded data to another disk.

Please follow the steps below to enable scheduled backup settings:

- Select the target station from the hierarchical management tree.
- Click **Configuration > Station Settings > Scheduled Backup Settings** on the menu bar (or **right-click** the station and select **Station Settings > Scheduled Backup Settings**).

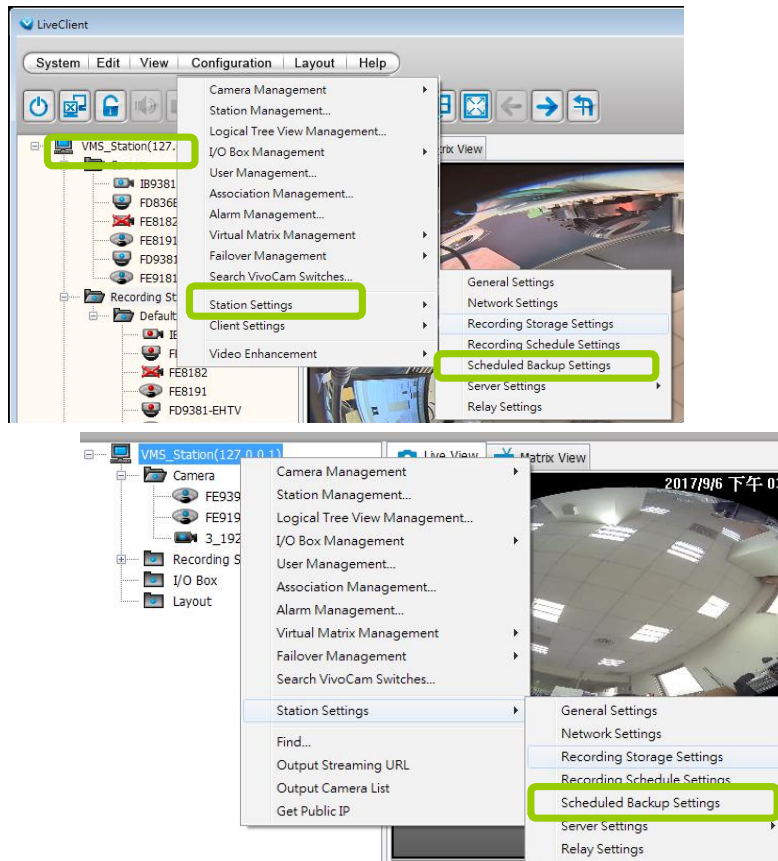

- The **Scheduled backup settings** window displays.

### Select Backup Source

- Select the Enable scheduled backup checkbox.
- Select the data source you want to backup. If you check **Selected cameras**, you can click >> or << to choose the data source that you want to backup.

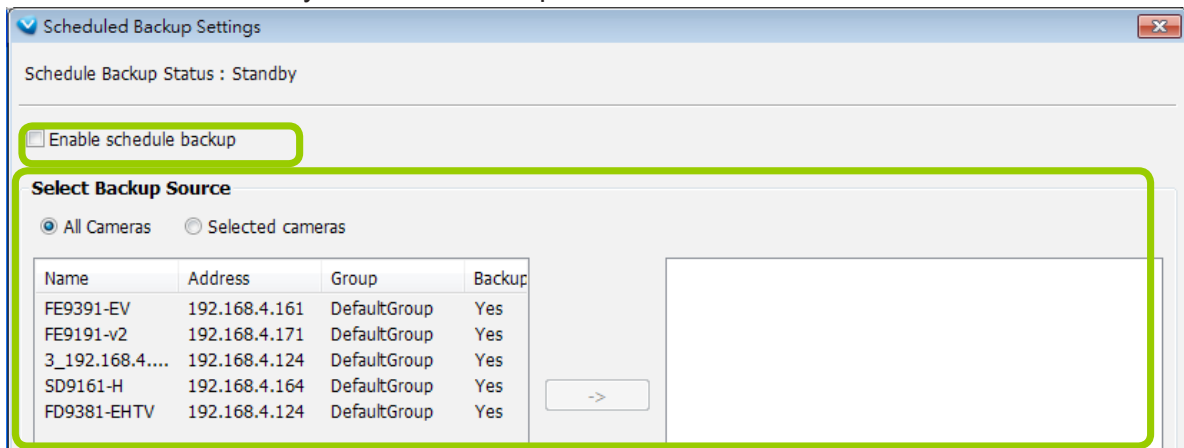

## Setup Backup Schedule

f. Click the Edit button to enter the configuration screen. Please note that the backup time interval must not be shorter than 1 hour. For example, 23:40 and 00:15 are not allowed to exist simultaneously.

In the following example, the server will backup the recorded data at 12:00 PM and 23:00 PM everyday once you save the settings.

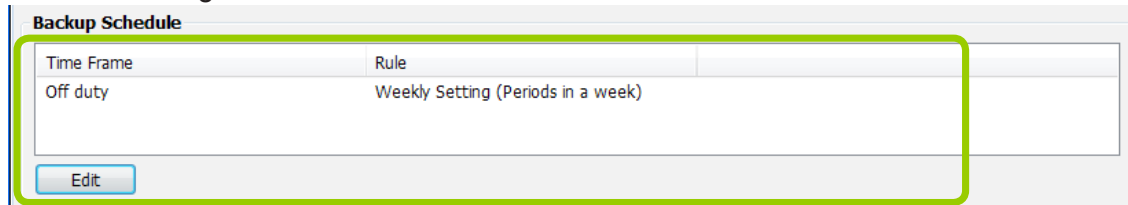

The following diagram shows the backup schedule and backup data:

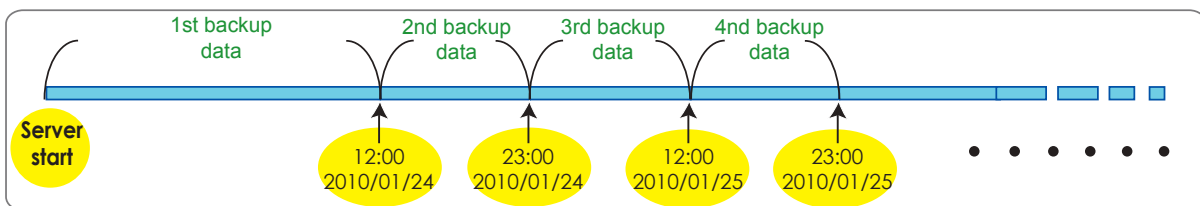

## Select Backup Target

g. Click **Browse...** to select a path (local path or network storage) to store the backup data. Please note that the disk for backup data should be different from the original recording path, or a warning message will pop up as shown below. For more information about how to set up recording path, please refer to page 136.

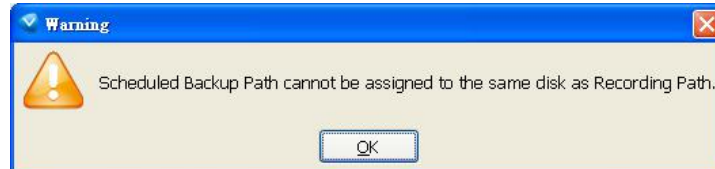

h. Select **Delete old backups if space is insufficient** if you want to do cyclic backup due to the limited size of the hard disk.

i. Select the backup speed. The speed range start from 0 to 100MB/s. "0" stands for no limitation. If bandwidth or system resource is of the concern, you can tune down the backup speed.

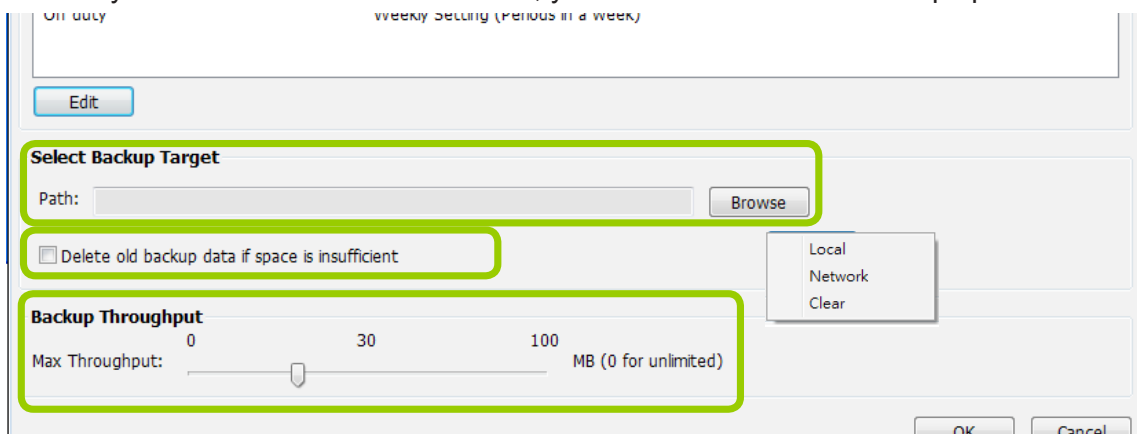

The backup destination folder should look like this "2016-07-06\_164500 > DISC\_001." A scheduled backup error log will be available for users to examine the backup history.

Since the scheduled backup is a file-based process, if the backup involves an unfinished video file (currently being recorded), the backup process will skip the file.

## How to Configure Station Server Settings

VAST LiveClient supports Server Settings including DDNS Settings, Network Storage Settings, and SMTP Settings.

Select the station from the hierarchical management tree and click **Configuration > Station Settings > Server Settings** to open the page (or **right-click** the station and select **Station Settings > Server Settings**).

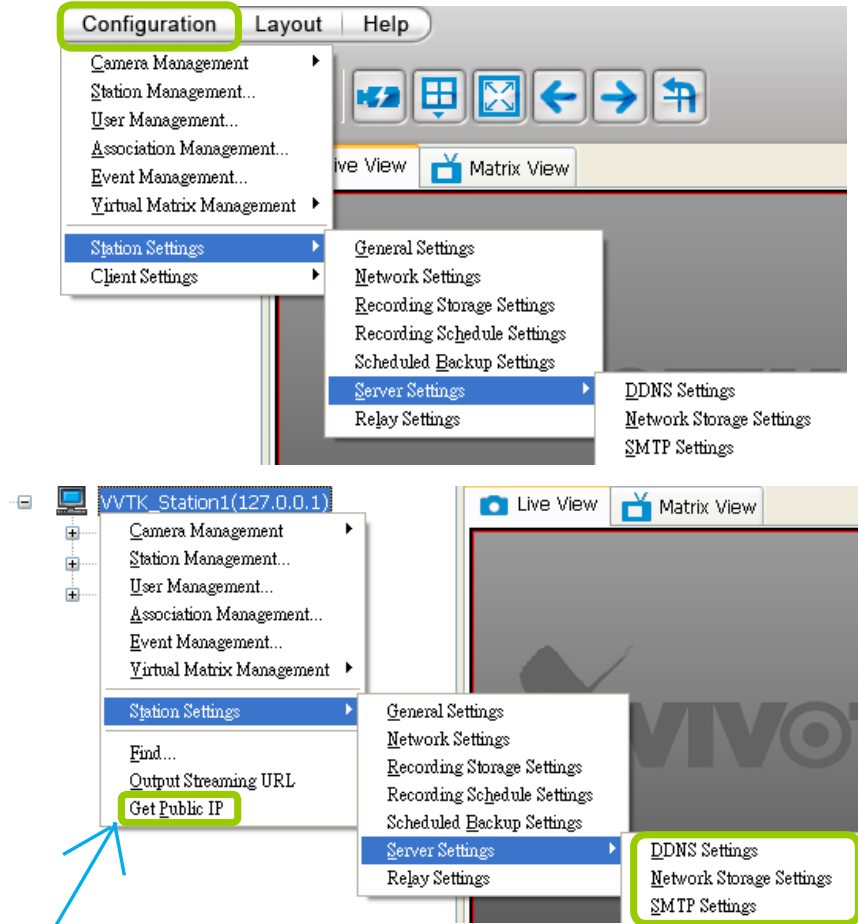

### DDNS Settings

Since the public IP of VAST Server may be a dynamic IP address, DDNS service will give it a fixed domain name.

Select a DDNS provider from the provider drop-down list. VIVOTEK offers [2bthere.net](http://2bthere.net) (Safe100.net), a free dynamic domain name service, to VIVOTEK customers. Please refer to the user's manual of VIVOTEK's network camera for detailed DDNS settings.

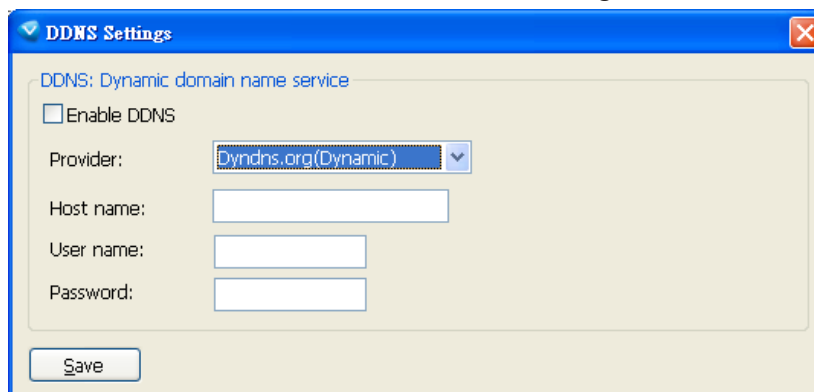

## Network Storage Server Settings

The VAST Server allows user to set up network storage path(s) for recorded files. Please follow the steps below to add a new network storage path.

- a. Click **Add** to open the Network Host Window.
- b. Fill in the related information for the network host. Then click **OK** to save the new settings.

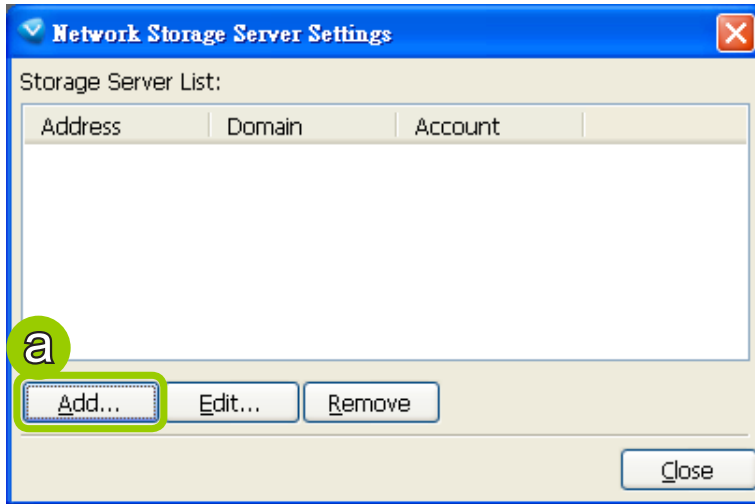

- c. If you want to add more network host(s), please repeat step a. b.

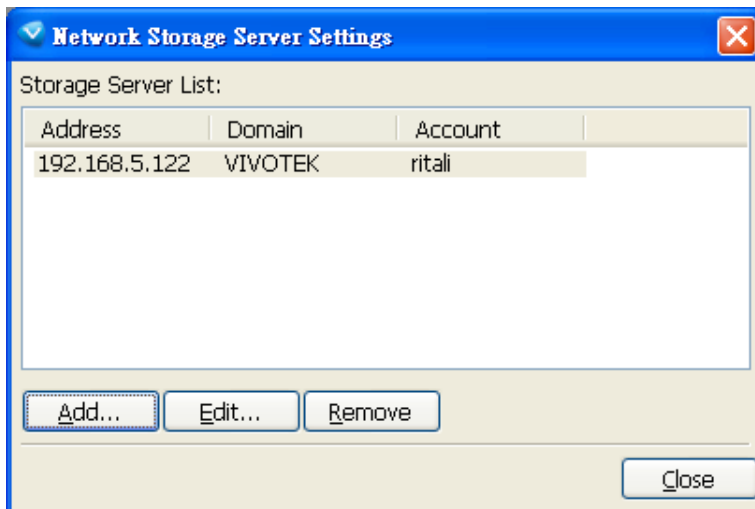

## SMTP Settings

VAST Server allows user to set up SMTP Server to send mail alert when event triggers. For more information about how to set up event management, please refer to page 111.

Please follow the steps below to configure the SMTP Server:

- Click **Add** to open the SMTP Settings page.
- Enter the related information of your mail server. If your SMTP server requires a secure connection (SSL), check **Use SSL**.
- Click **OK** to enable the settings.
- Then the new information will appear on the SMTP Settings window as shown below.

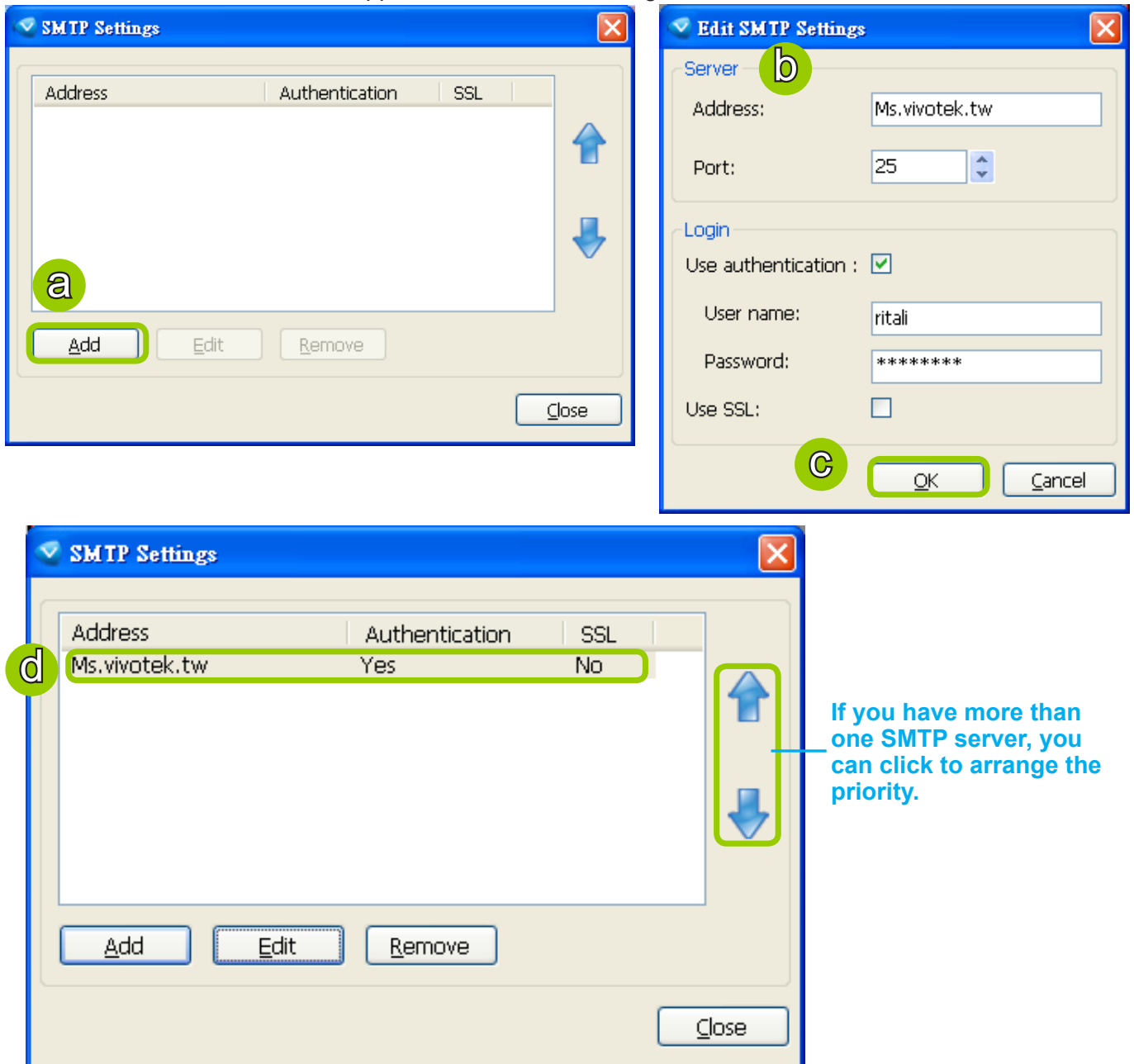

## How to Use the Talk Panel

VAST LiveClient supports the two way audio function which allows the user to communicate with people around the network camera. Please enable the two way audio function on the camera side.

The following is an illustration of the two way audio function:

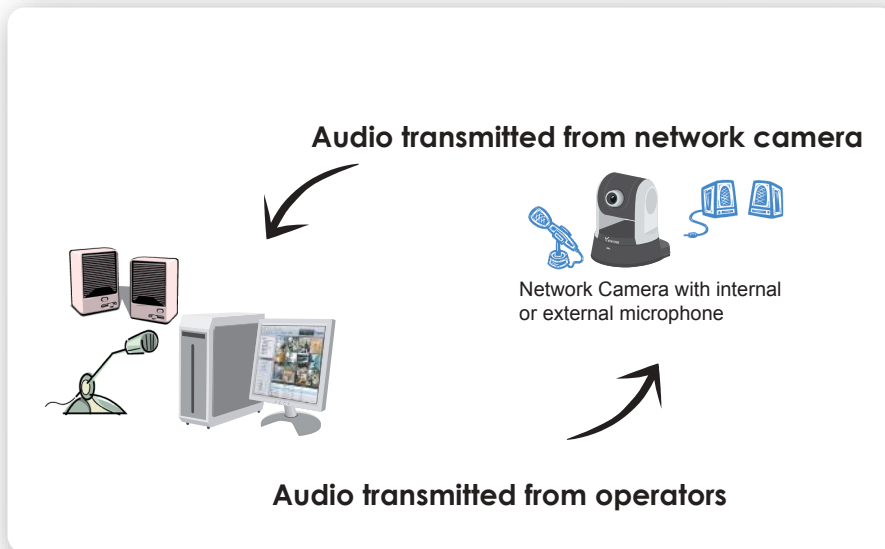

## Add a Camera to the Talk Panel

- There are several ways to add a Network Camera to the Talk Panel:

Drag-and-drop a camera from the video cell or from the hierarchical management tree to the talk panel as shown below. You can also **right-click** the target camera or the video cell, then click **Send to Talk Panel** on the pop-up menu.

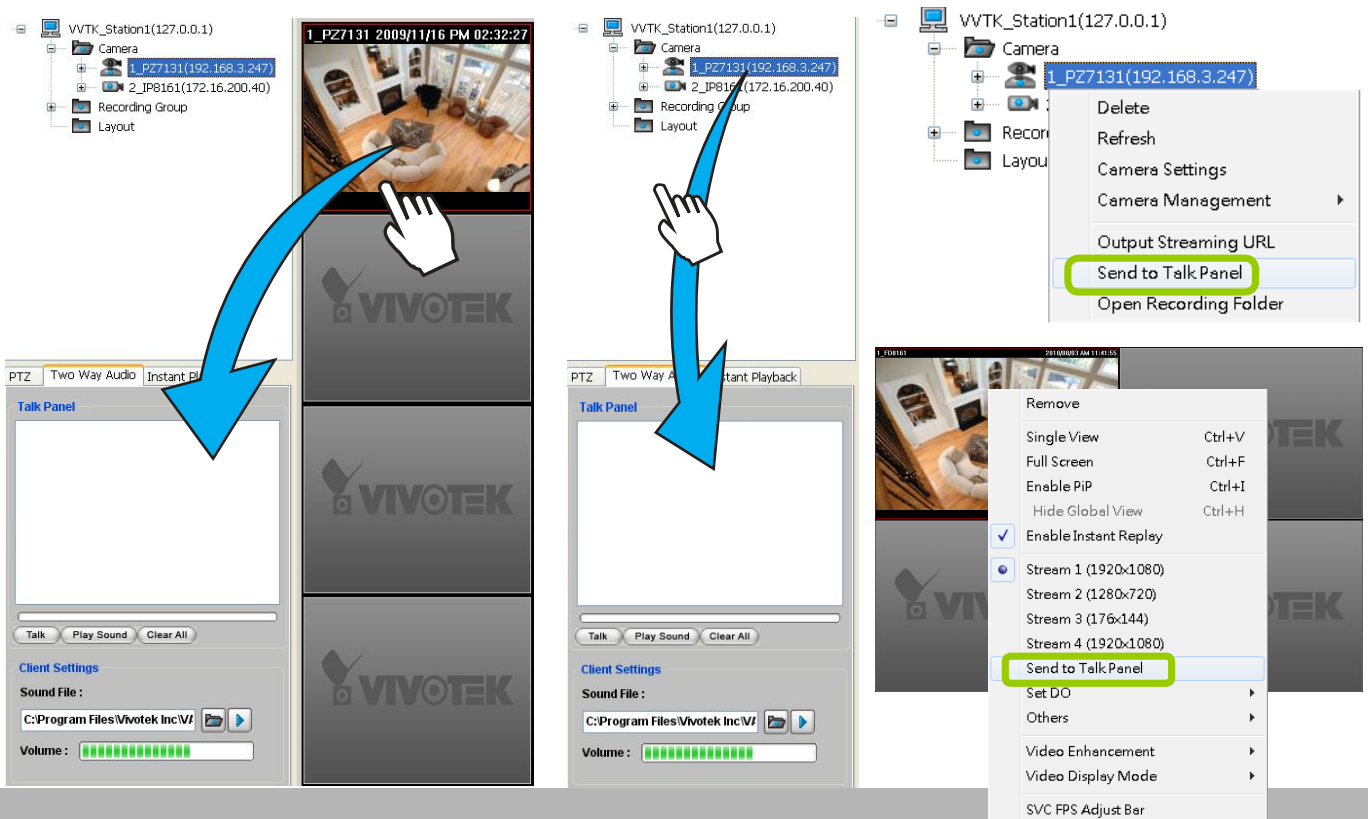

- An icon with the camera name will be displayed in the Talk Panel.

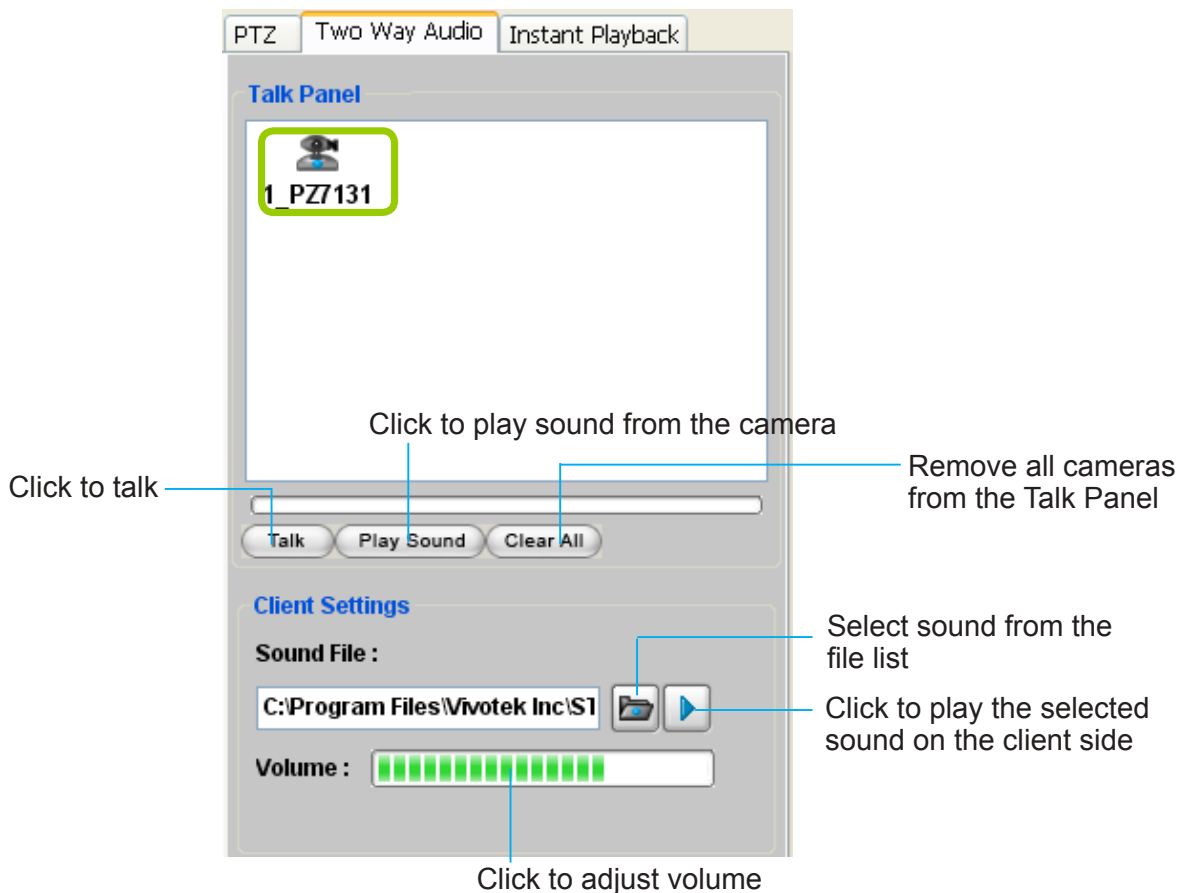

- Please note that you cannot **Talk** and **Play Sound** at the same time.
- When you are talking or playing sound, you cannot add other cameras to the Talk Panel. If you want to add more cameras to the Talk Panel, please **Stop Talking** and **Stop Playing** first.

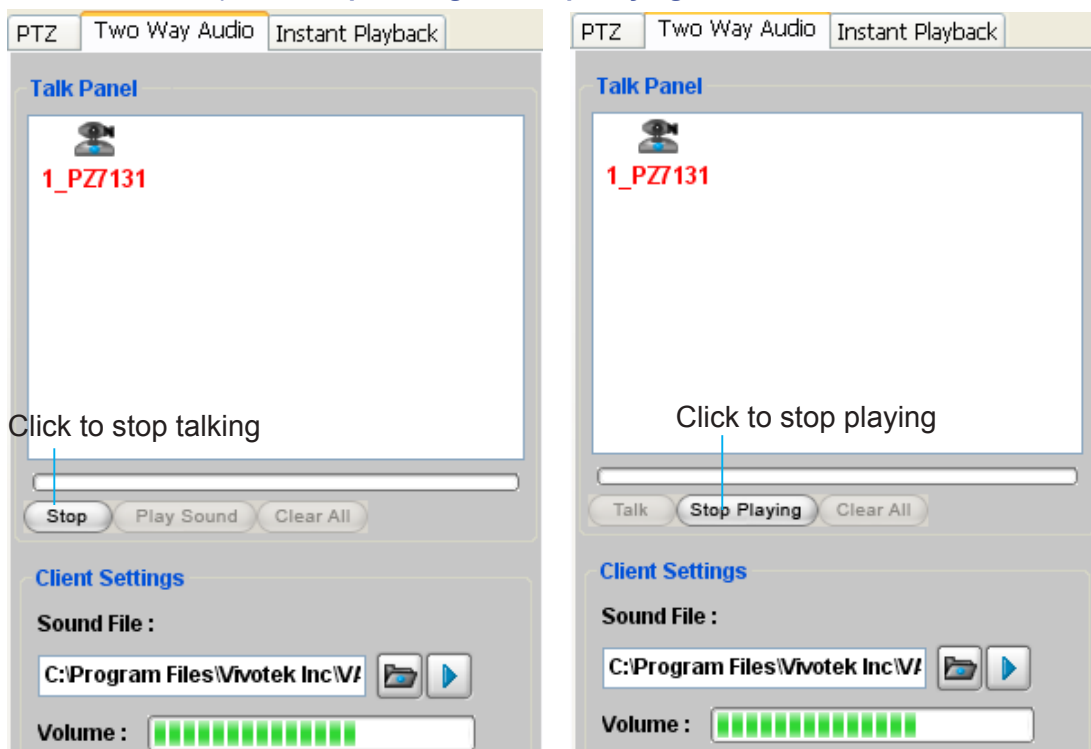

## Remove a Camera from the Talk Panel

### ■ Remove a camera

Drag a camera from the Talk Panel and drop to the hierarchical management tree window as shown below. The camera icon will disappear.

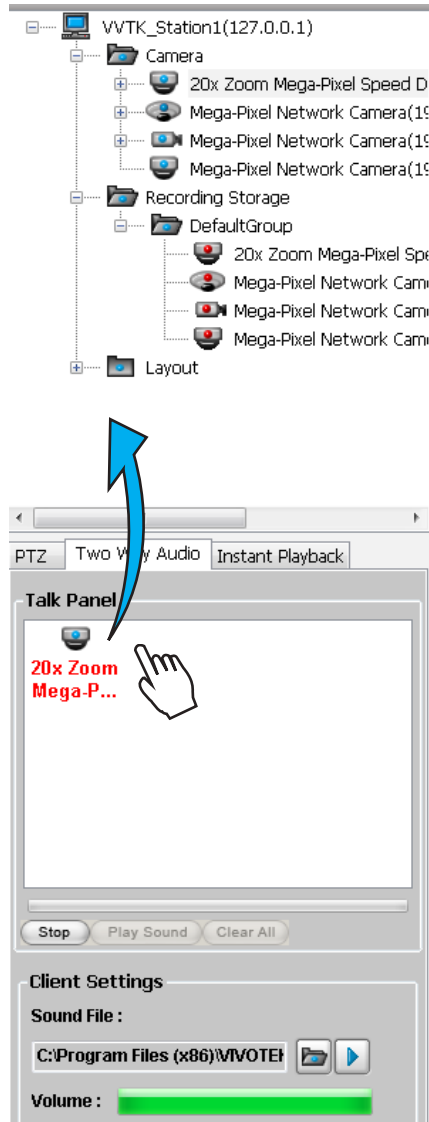

### ■ Remove all cameras

Click **Clear All** , all cameras in the Talk Panel will be removed.



## How to Configure E-map Settings

VAST LiveClient supports intuitive E-map function which allows users to upload E-maps for overall devices management.

Click **System > E-map** to open E-map Settings Page:

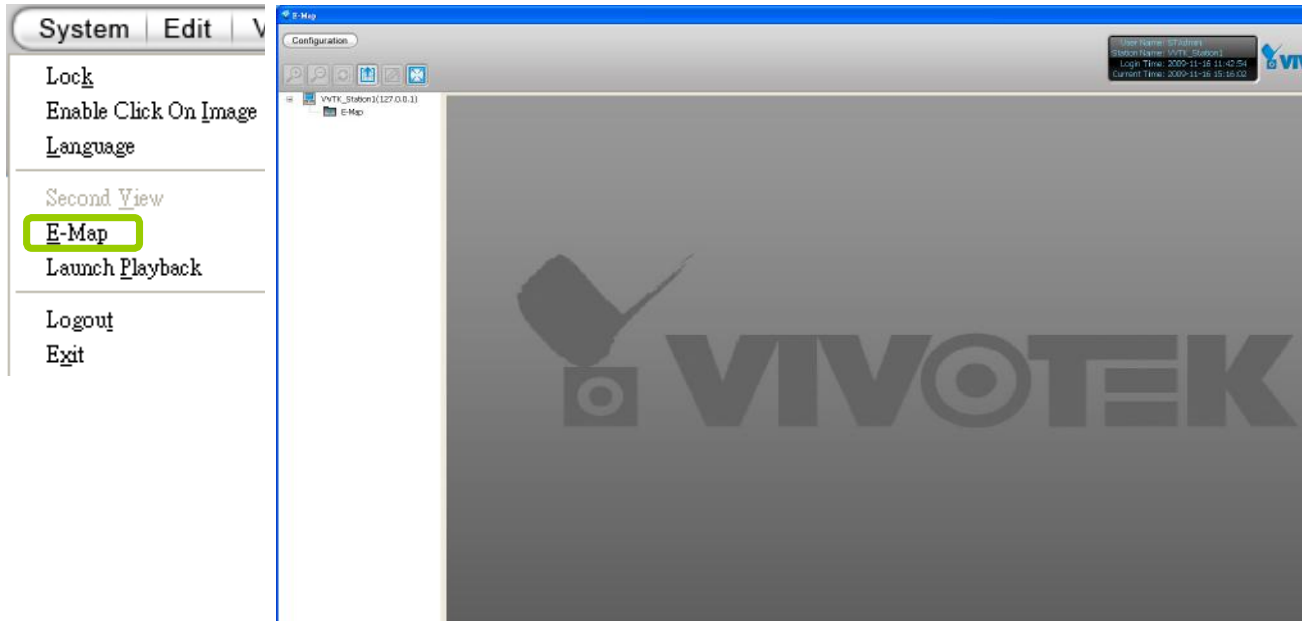

### Upload an E-map

Click  to search for E-map(s) to upload.

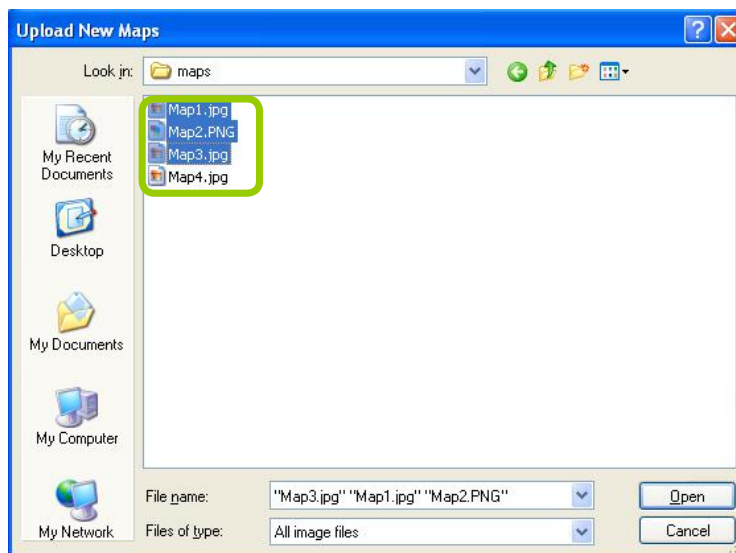

The uploaded E-maps will be listed under the E-map list tree.



*If the uploading procedure fails, please compress the image size of your map (equal or smaller than 2MB) and try again.*

## User Interface of E-map Settings Page (View Mode)

- Double-click** an E-map on the tree, it will be displayed on the E-map window as shown below. There are two operation modes of E-map settings page: "View Mode" and "Edit Mode". The following is the "View Mode" illustration.

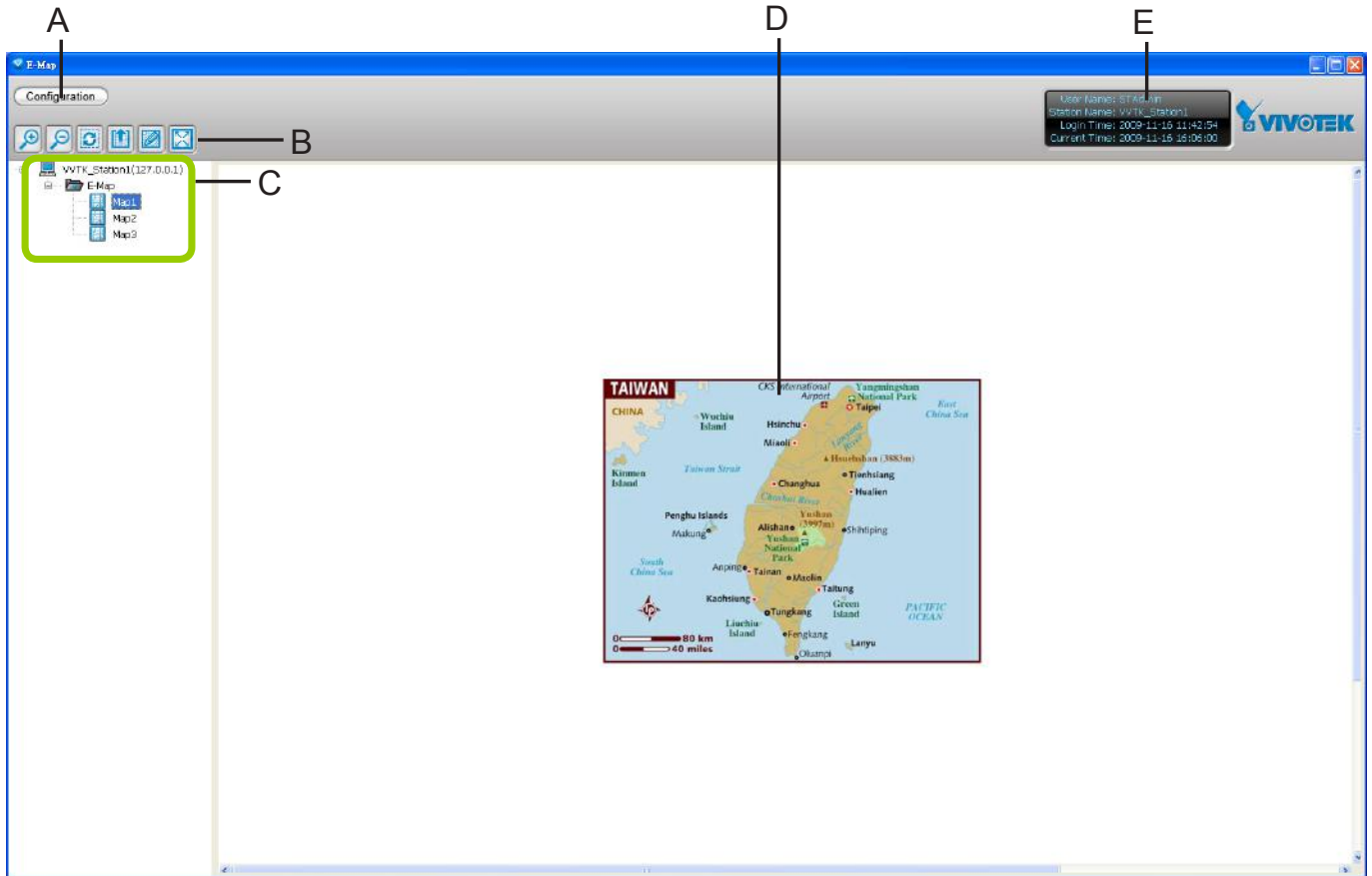

A. Menu bar    B. Quick access bar    C. E-map list tree    D. E-map window    E. Status panel

- Right-click** the E-map, then you can **Edit**, **Rename**, or **Delete** the E-map.

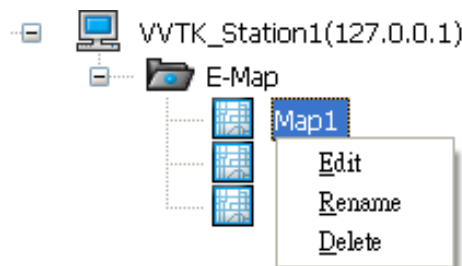



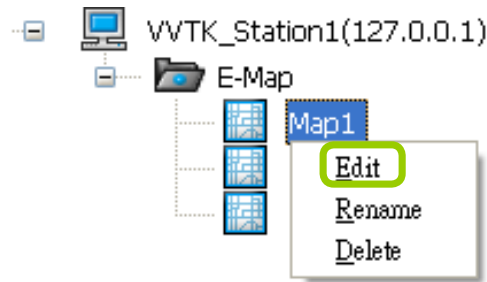



- **Right-click** an E-map on the tree and click **Edit** or click  on the Quick Access Bar, it will switch to edit mode.



### Quick Access Bar



Icon	Function	Description
	<b>Zoom in</b>	Zoom in the E-map
	<b>Zoom out</b>	Zoom out the E-map
	<b>Default size</b>	Adjust the E-map to default size
	<b>Upload</b>	Upload E-map to the login station
	<b>View Mode</b>	Click to switch to view mode
	<b>Full Screen</b>	Extend the E-map settings page to full screen
	<b>Save</b>	Save E-map settings

### Status Panel

User Name: admin	CPU
Station Name: VWTK_Station1	35 %
Login Time: 2014-04-22 10:23:09	Memory
Current Time: 2014-04-22 11:14:54	61 %

User Name
Station Name (IP Address)
Login Time (yyyy-mm-dd hh:mm:ss)
Current Time (yyyy-mm-dd hh:mm:ss)

## User Interface of E-map Settings Page (Edit Mode)

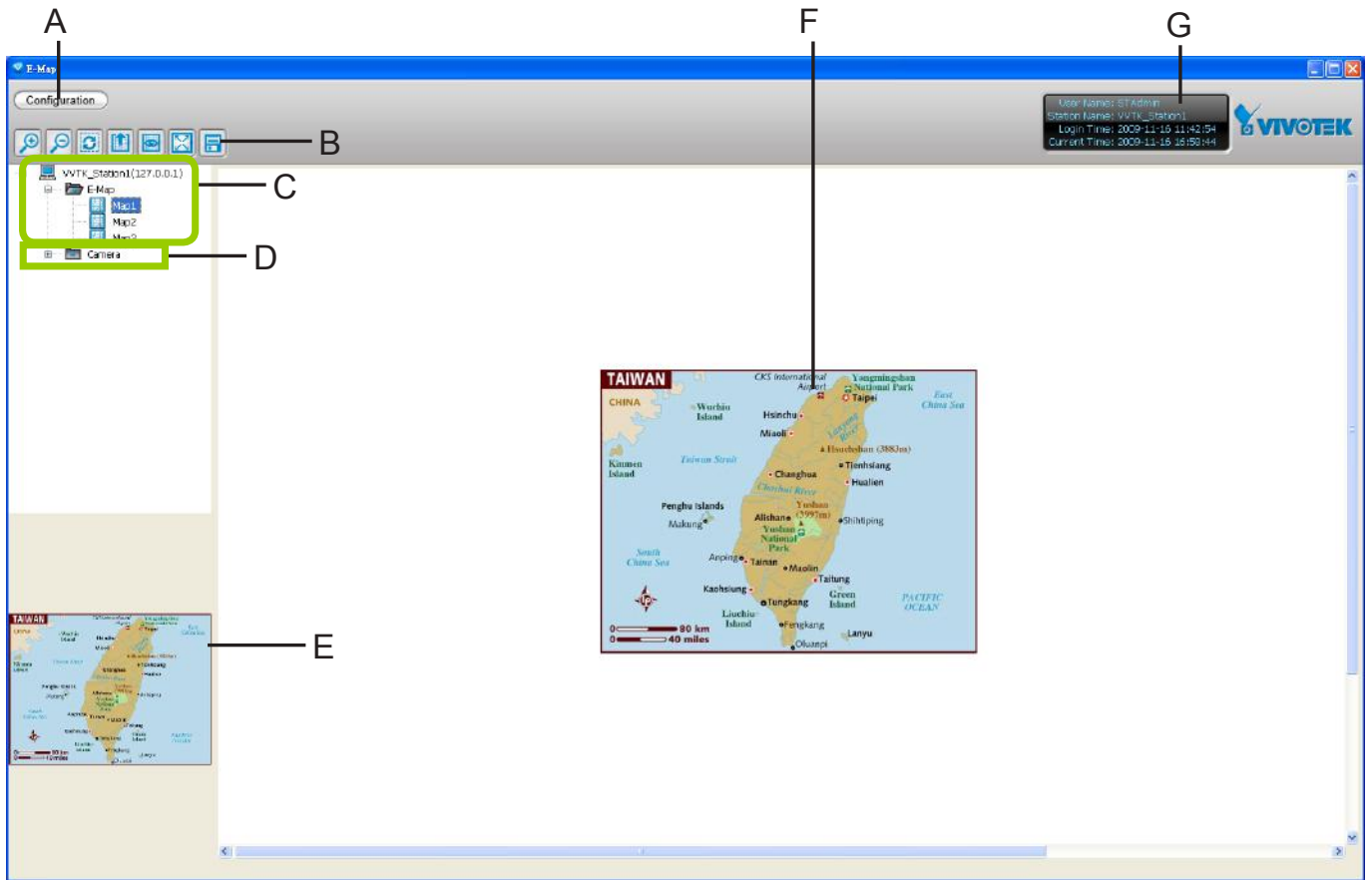

- A. Menu bar
- B. Quick access bar
- C. E-map list tree
- D. Device tree
- E. Map preview
- F. E-map window
- G. Status panel

■ Right-click the E-map, you can **Edit**, **Rename**, or **Delete** the E-map.

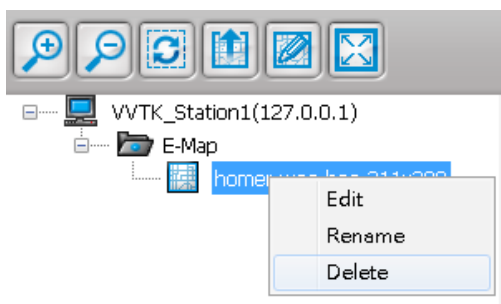

## Device Management

Please follow the steps below to edit an uploaded E-map.

- Double-click** the E-map you want to edit, it will be displayed on the E-map window.
- Use Quick Access Bar to adjust the size of the E-map. In edit mode, you can also use your mouse to drag the position of the E-map and zoom in or zoom out the E-map.
- Drag-and-drop** the connected devices to the E-map according to your deployment.

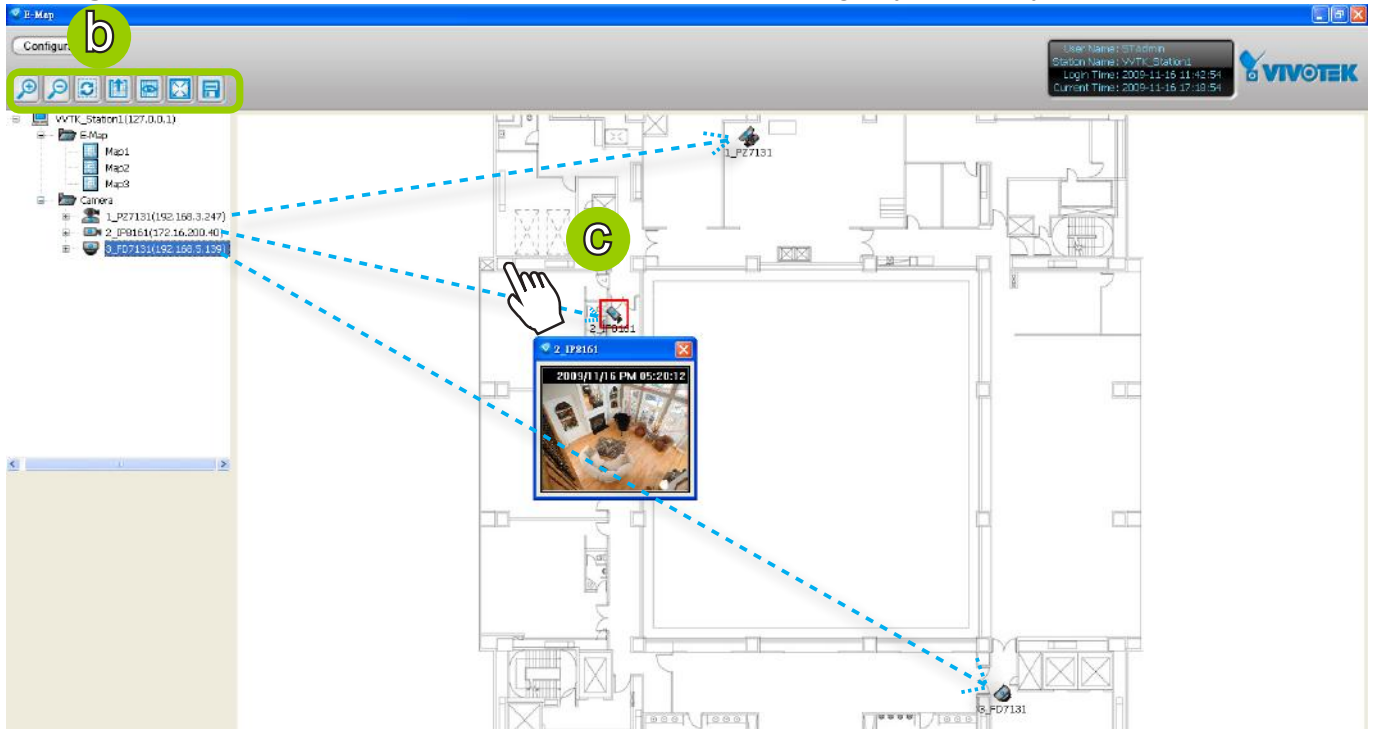

- Right-click** the device icon on E-map, you can **rotate** the direction or **delete** the device. The device can be rotated in 8 directions as shown below.



- You can also drag the DI/DO device under the connected device onto the E-map. If you want to change the status of the **DO** device, **double click** the DO icon on E-map.

For more information about DI/DO settings, please refer to Association Management on page 109.

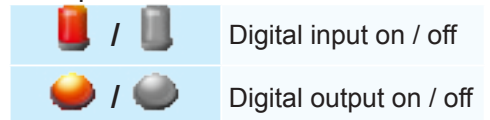

- Click  on the Quick Access Bar to save the new settings.



*The red frame twinkling around the device means there is event trigger(s) going on. Meanwhile, a live view dialog will pop up beside the model.*



## Live View Dialog Settings

Click **Configuration > E-map Settings** to open the E-map Settings dialog, then you can choose to **Open Live View Dialog** or to **Send to Single View** when you double-click the device deployed on the E-map.

### Open Live View Dialog

Select **Open Live View Dialog**: When you **double-click** the device icon on the E-map or when an event triggers, a live view dialog will pop up beside it. It is the default setting in E-map Settings window.

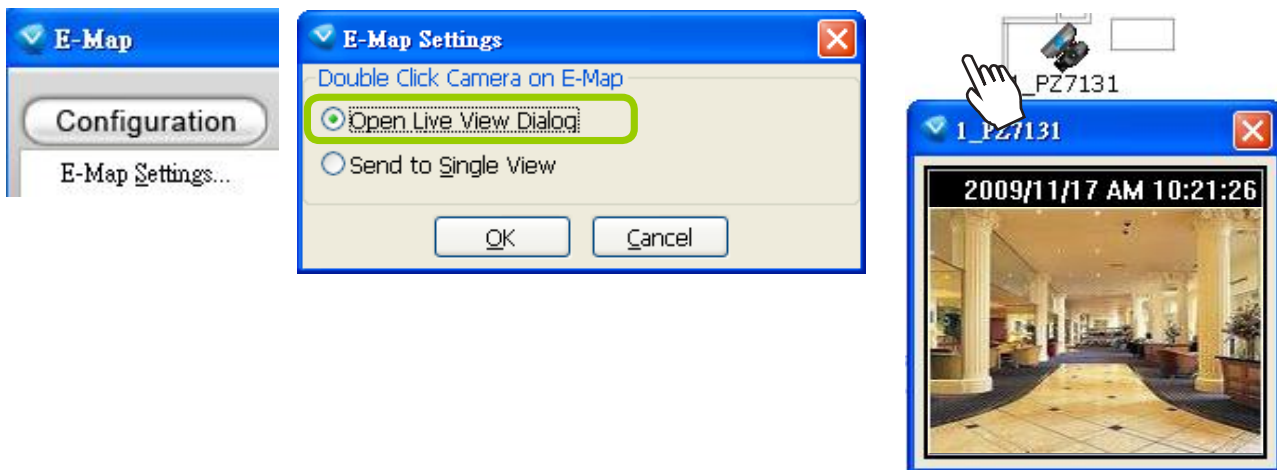

### Send to Single View

Select **Send to Single View**: When you **double-click** the device icon on the E-map, it will open a single view on the VAST LiveClient.

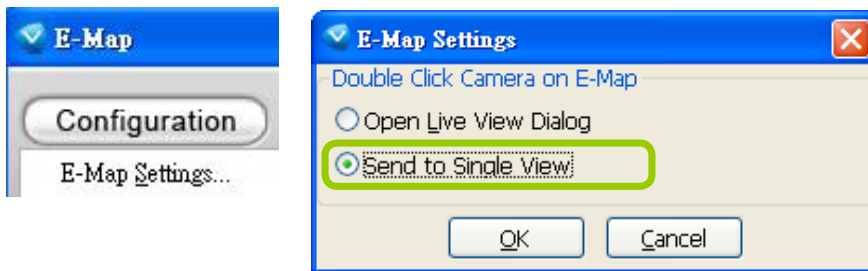

If you have set up dual monitor, it will be automatically sent a single view to the second monitor.

Monitor 1

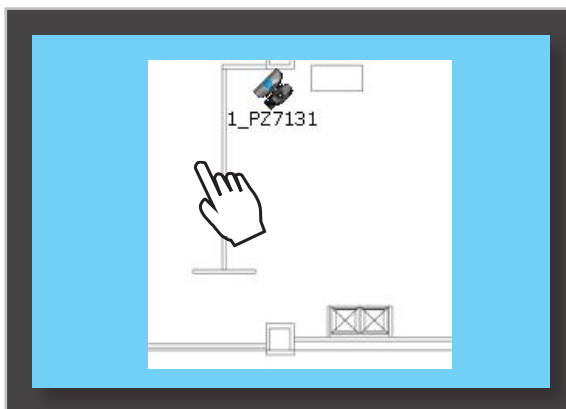

Monitor 2

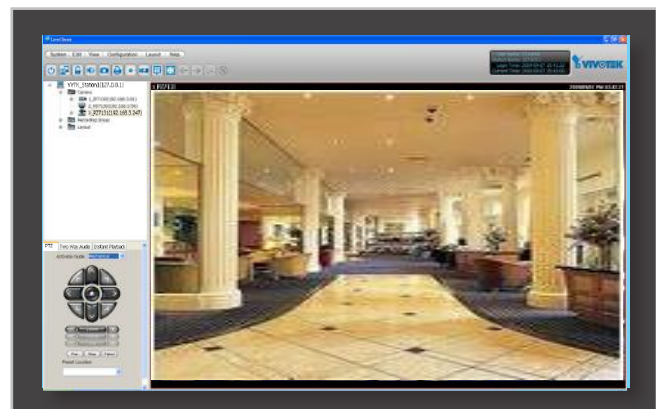



The live view dialog also supports **click on image**, **PTZ**, and **e-PTZ** as long as the linked device supports and enables those functions. To enable those function on E-map, please check the item "Enable click on image" on the menu bar of LiveClient as shown below. Then an icon  will appear in the live view dialog for you to control the cameras.



## E-map Link

After completing device deployment on your E-map, you can link an E-map to another E-map. Please follow the steps below to configure E-map link:

a. Select a map you want to edit and enter **Edit Mode**.

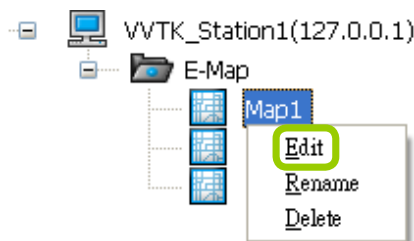

b. **Drag-and-drop** another E-map onto current E-map. A blue frame will appear as shown below. For example: Link Map1 to Map2 by dargging Map2 onto Map1

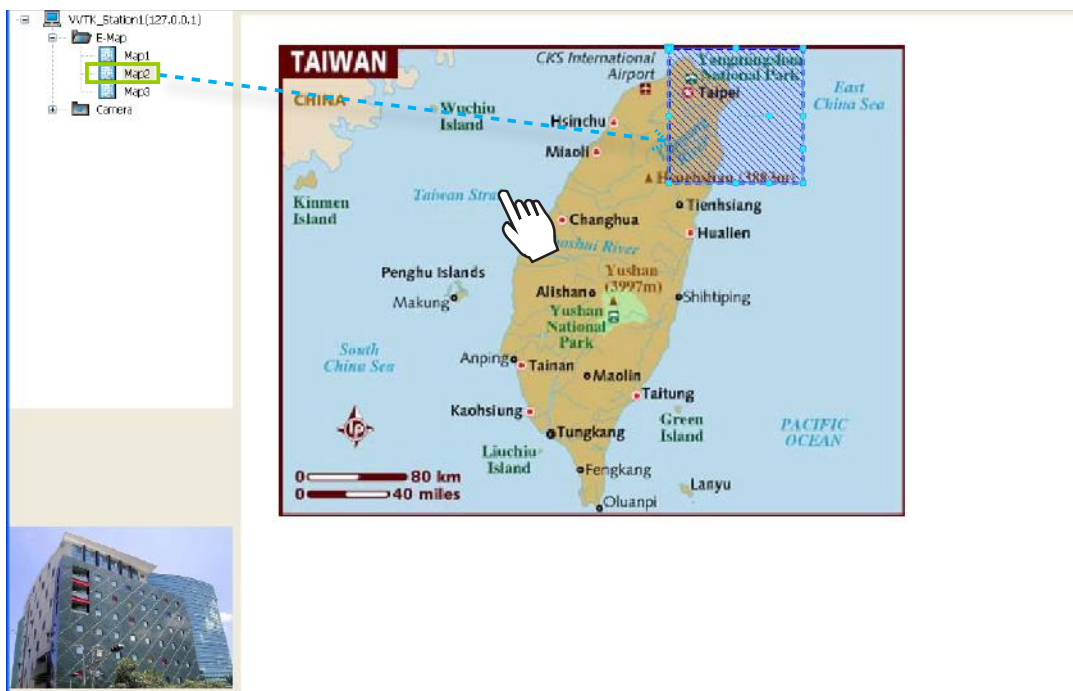

c. Use  to move the position of the blue frame.

d. Right-click the blue frame to **Resize** or **Delete** it.



Click **Resize**, some nodes will appear around the blue frame. Then You can drag the nodes to move the position, rotate the direction, adjust the size, and change the shape.

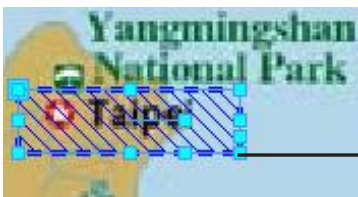

resize

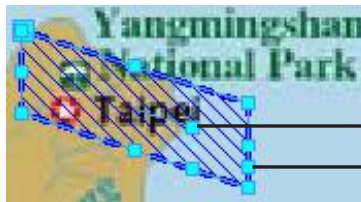

rotate the direction  
change the shape



move the position

e. Click  on the Quick Access Bar to save the new settings.

f. If you want to set additional map links, please repeat steps a. ~ e.  
For example: Link Map2 to Map3 by dargging Map3 onto Map2

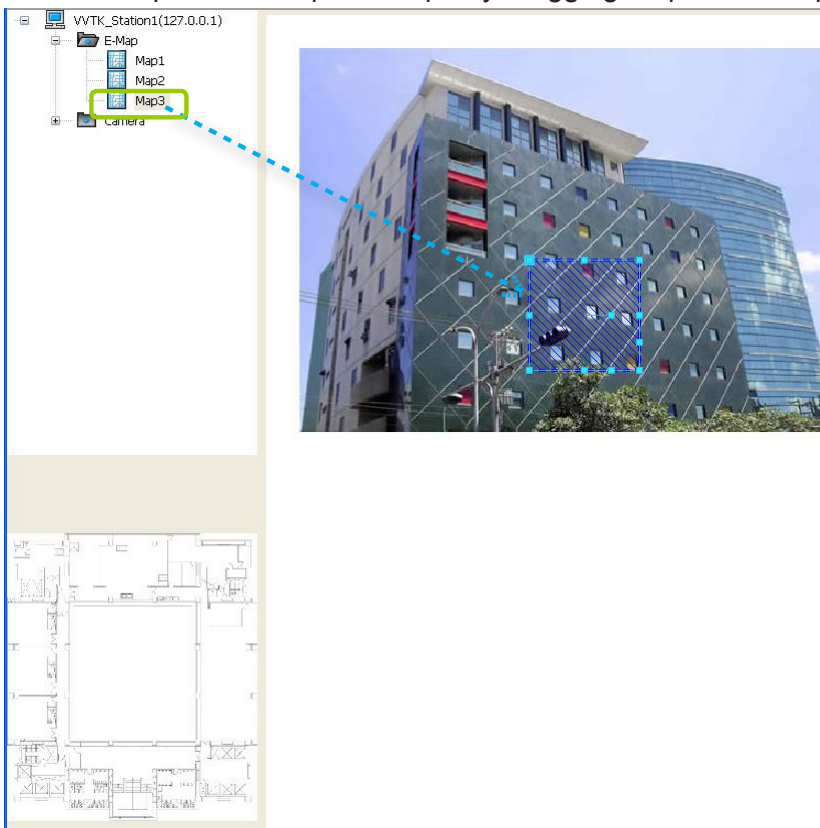

g. Click  on the Quick Access Bar to save the new settings.



h. Test the web links. Click  on the Quick Access Bar to switch to view mode. **Double-click** the blue frame on Map1, it will automatically switch to map2. Then **double-click** the blue frame on Map2, it will automatically switch to map3.



Map 1

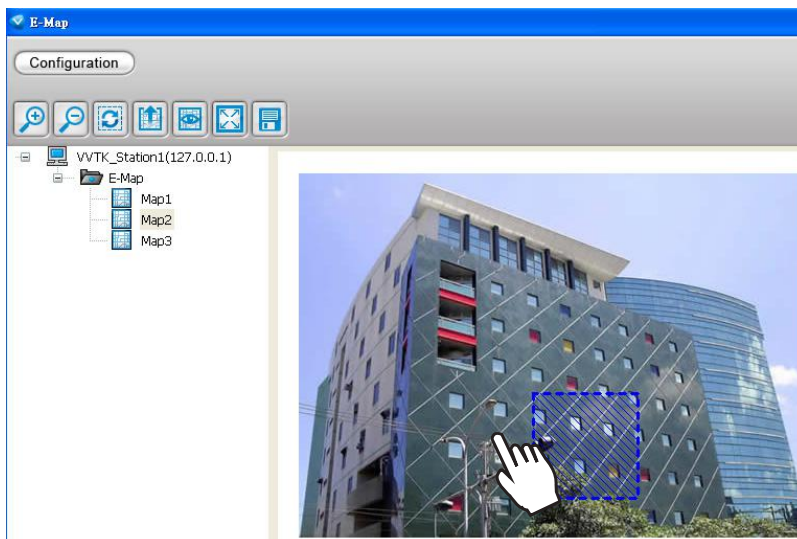

Map 2

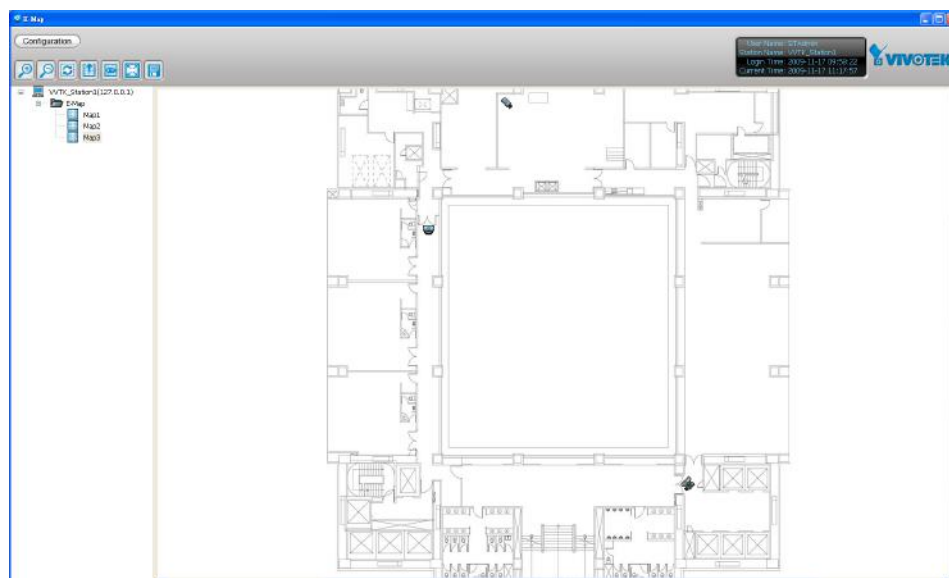

Map 3

Since VAST revision 1.13, you can also click and drag camera or NVR's DI/DO devices to an E-map. See page 57 for how to enable NVR DI/DO options.

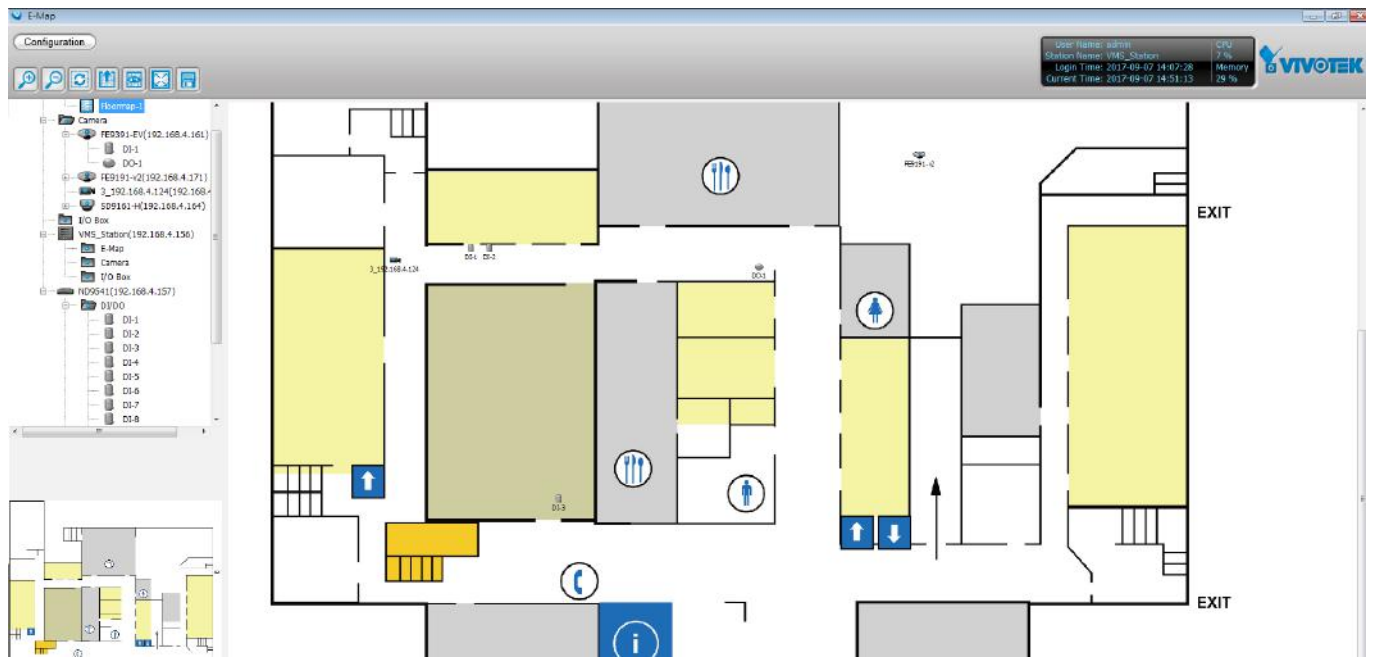

See page 191 for how to enable popup video windows on E-Map. y

## How to Configure Client Settings

In Client Settings, you can configure Snapshot Settings, Recording Settings, View Settings, General Settings, Joystick Settings, Proxy Settings, and PiP Settings.

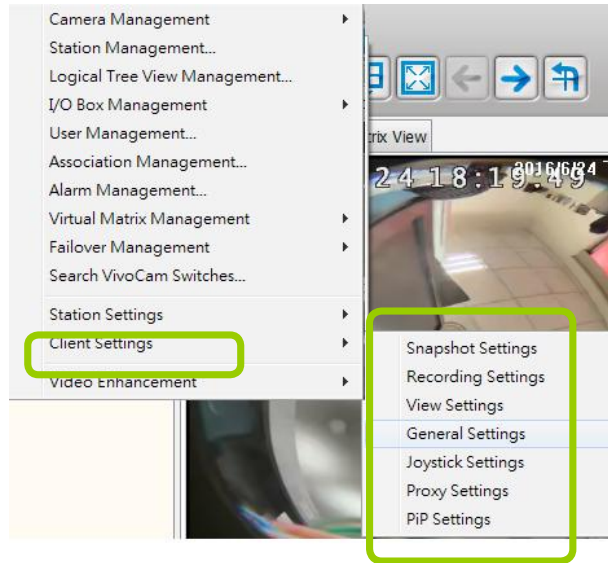

### Snapshot Settings

Please follow the steps below to configure snapshot settings:

- Click **Configuration > Client Settings > Snapshot Settings** on the menu bar to open the **Snapshot Settings** window.
- By default, camera name and current time will be printed on the snapshots taken.
- Select a picture format for snapshots (**BMP** or **JPEG**). If you select **JPEG** format, you can adjust the recompression quality (from 1 to 100). Note that a higher value would generate higher picture quality but lower compression rate.
- Fill in a filename prefix for the snapshots.
- The default storage path for snapshots is C:\Users\Public\Documents\VIVOTEK Inc\VAST\Client\LiveClient. If you want to change the storage path, click **Browse ...** to select another folder.

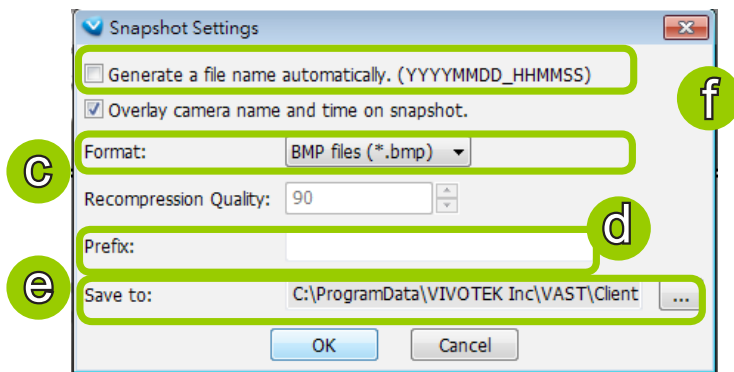

*The recompression quality is only enabled in MPEG-4 streaming. If your stream source is MJPEG, the system will directly save the JPEG image without recompression.*

- If you check **Generate a file name automatically**, VAST will directly save snapshots with the following filename format to the storage folder.

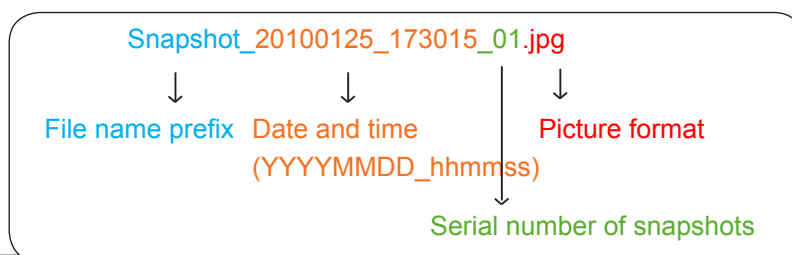

If you uncheck **Generate a file name automatically**, the **Save file** dialog box will pop up when you take a snapshot. The file name prefix will automatically be displayed in the Save File dialog box.

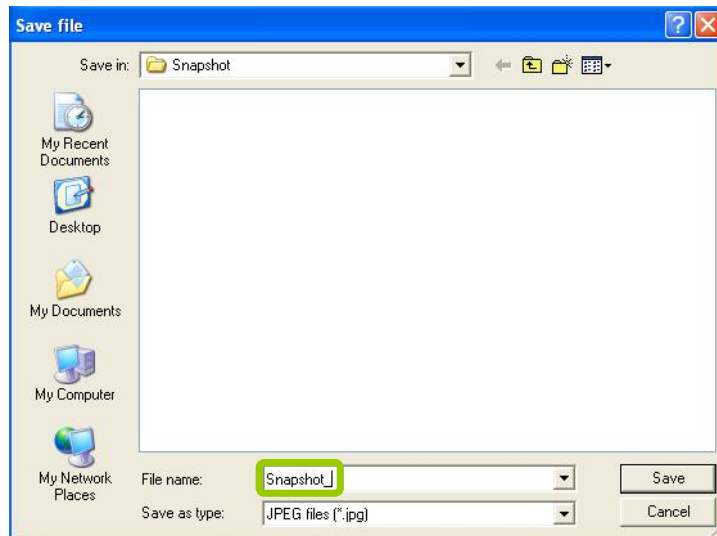

### Take a Snapshot

Please follow the steps below to take a snapshot of the live video stream:

- a. Select the video cell of which you want to take a snapshot.
- b. Click **Snapshot**  on the quick access bar, or **right-click** the video cell and select **Others > Snapshot** from the popup menu. You also can click **Edit > Snapshot** to take a snapshot.

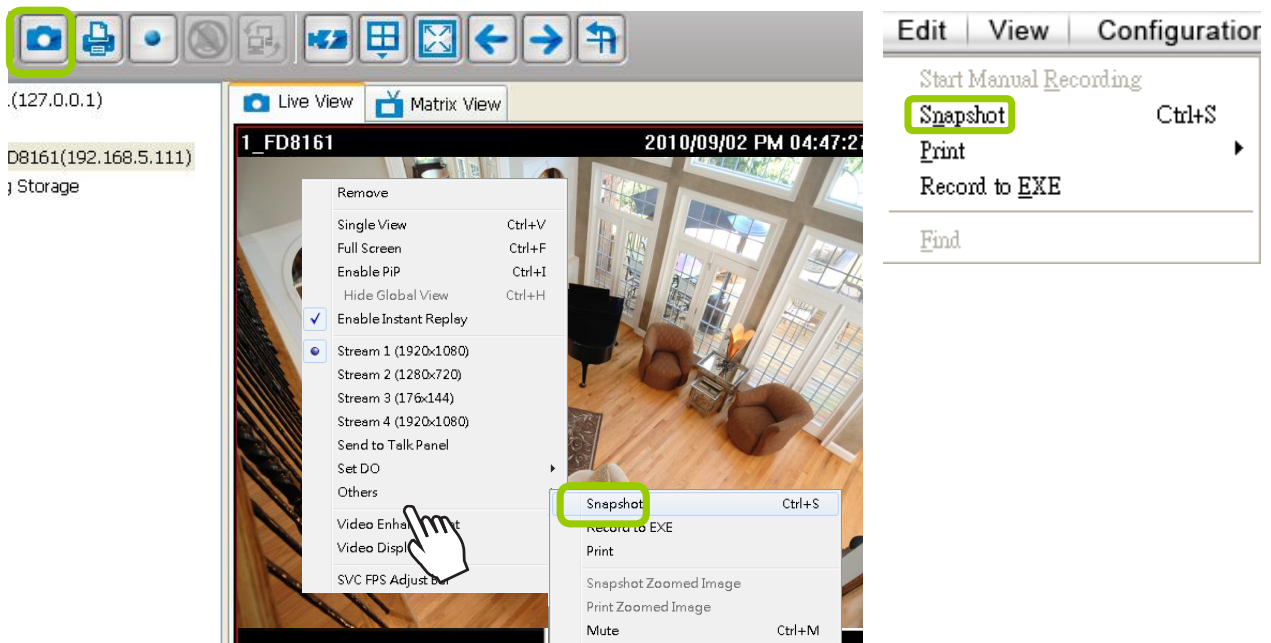

- c. The snapshots will be found in the preset storage folder on your local computer.

## Recording Settings

The VAST Server allows you to record the live video in EXE, 3GP, or AVI format to your storage folder.

### Type 1: Record to EXE

Record video as an EXE file. The EXE is not only a media file but also a built-in media player. When user execute the EXE, the media file will be played automatically. There is no need to install any other program. For more information about how to use the EXE player, please refer to page 185.

Please follow the steps below to configure EXE record settings:

- Click **Configuration > Client Settings > Recording Settings** on the menu bar to open the **Recording Settings** window.
- Select **EXE** as the Record Type.
- The default storage path is C:\Users\Public\Documents\VIVOTEK Inc\VAST\Client\LiveClient\Record. If you want to change the storage path, click **Browse ...** to select another folder.
- Select the Length of each file-- **Maximum Size** (11~2000MB) or **Maximum Time Interval** (1~150 min).

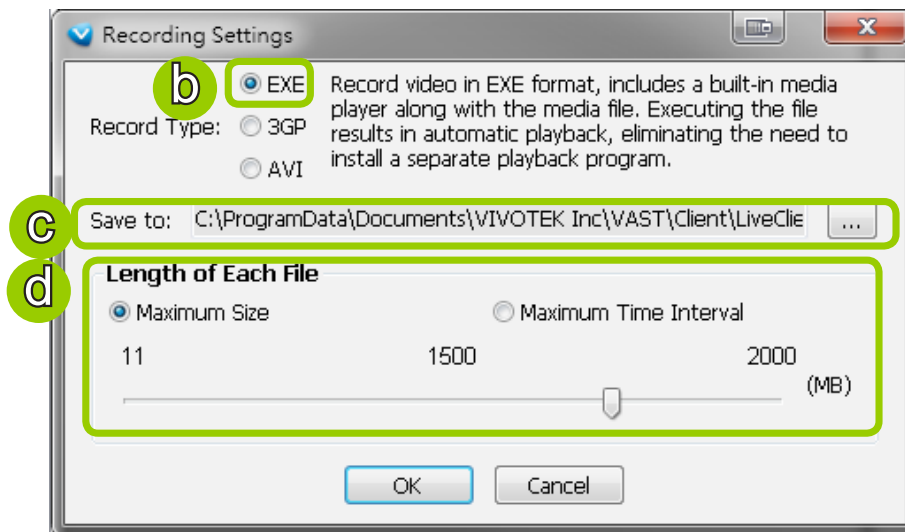

- Click **OK** to enable the settings.

### Type 2: Record to 3GP

Record video as a 3GP file. 3GP file is a standard MP4 format compatible with players such as VLC player. Choose this type if you has already installed one of these players.

Please follow the steps below to configure 3GP record settings:

- Click **Configuration > Client Settings > Recording Settings** on the menu bar to open the **Recording Settings** window.
- Select **3GP** as the Record Type.
- The default storage path is C:\Users\Public\Documents\VIVOTEK Inc\VAST\Client\LiveClient\Record. If you want to change the storage path, click **Browse ...** to select another folder.
- Select the Length of each file-- **Maximum Size** (1~2000MB) or **Maximum Time Interval** (1~150 min).

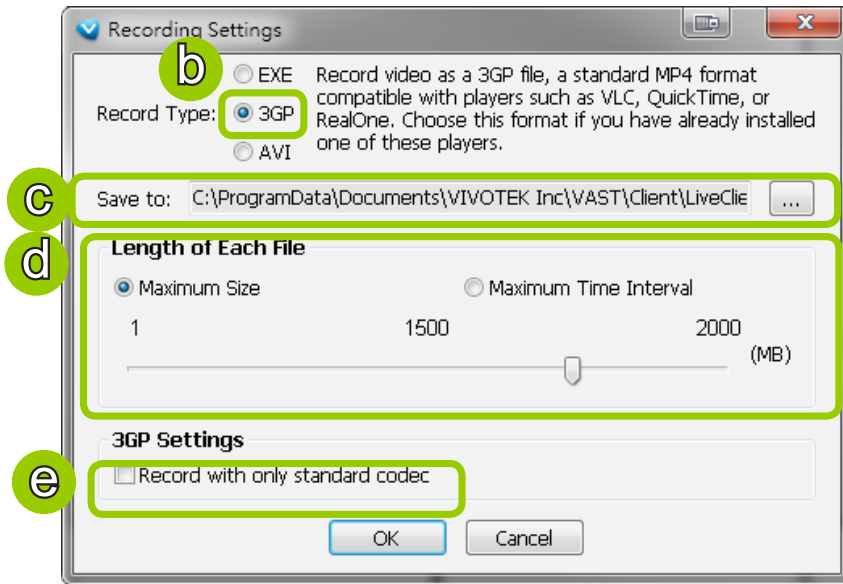

- e. If you check "Record with only standard codec", the video from old models (VIVOTEK 6000-series products) using H.263 codec will not be recorded.
- f. Click **OK** to enable the settings.

### Type 3: Record to AVI

Record video as an AVI file, which uses the popular codecs pre-installed in the Windows OS. Please note that the speed may be slower due to the need of decoding the video/audio and re-encoding both into a compatible codec.

Please follow the steps below to configure AVI record settings:

- a. Click **Configuration > Client Settings > Recording Settings** on the menu bar to open the **Recording Settings** window.
- b. Select **AVI** as the Record Type.
- c. The default storage path is C:\Users\Public\Documents\VIVOTEK Inc\VAST\Client\LiveClient\Record. If you want to change the storage path, click **Browse ...** to select another folder.
- d. Select the Length of each file-- **Maximum Size** (1~2000MB) or **Maximum Time Interval** (1~150 min).

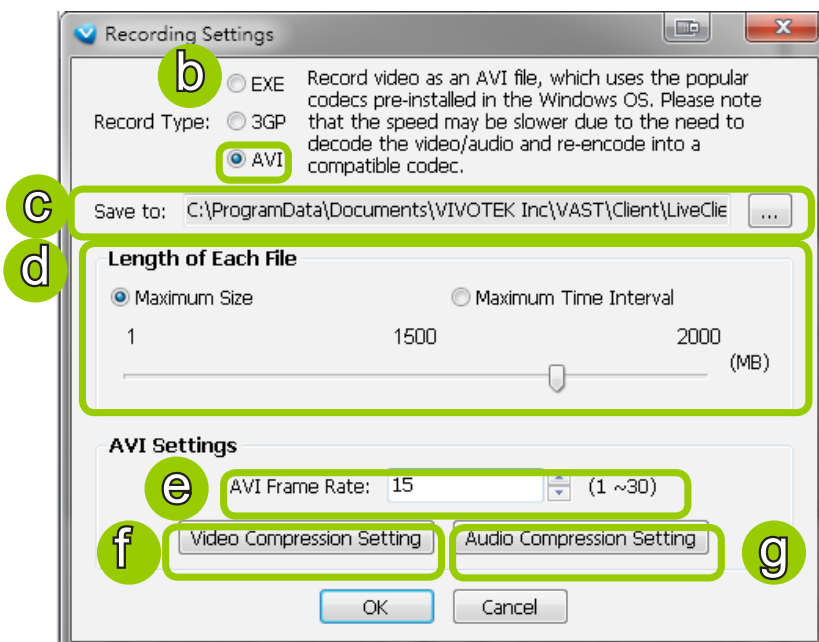

*Due to the AVI file has a limitation on the maximum file size of 2G bytes, if the setting "time length" generates data larger than 2G bytes, several files will be created.*

- e. Select the frame rate/ per second.
- f. To modify the video compression settings, click **Video Compression Setting** to open the AVI Video Compression Setting window. Select the desired **video compression algorithm, compression quality, key frame intervals, and data rate** in the corresponding fields.

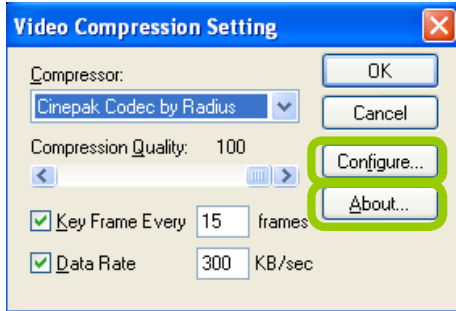

*If you do not choose to compress the video, the generated AVI will be very large in file size.*

- To modify the settings of the compression algorithm: Click **Configure**, then a dialog box will pop up for you to modify the settings. The dialog box will be different according to the compressor you select.



- To read the information of a compression algorithm (its version for instance): Click **About**, and a dialog box will pop up showing the related information. The dialog box will be different according to the compressor you select.

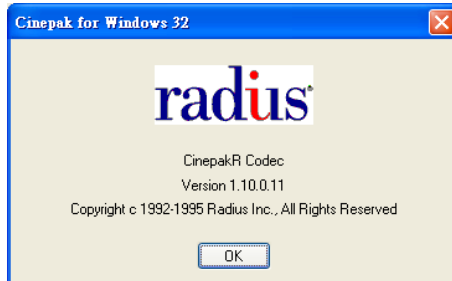

- g. To modify the audio compression settings, click **Audio Compression Setting** to open the AVI Audio Compression Setting window. Select the desired **audio quality, format, and attributes** in the corresponding fields.

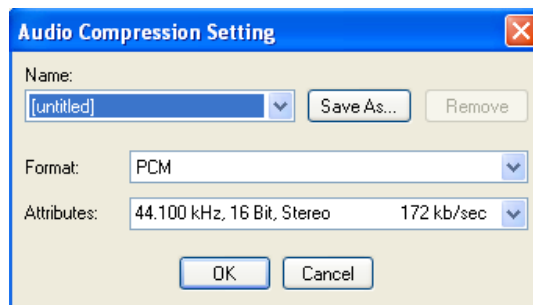

## Record an EXE/3GP/AVI File

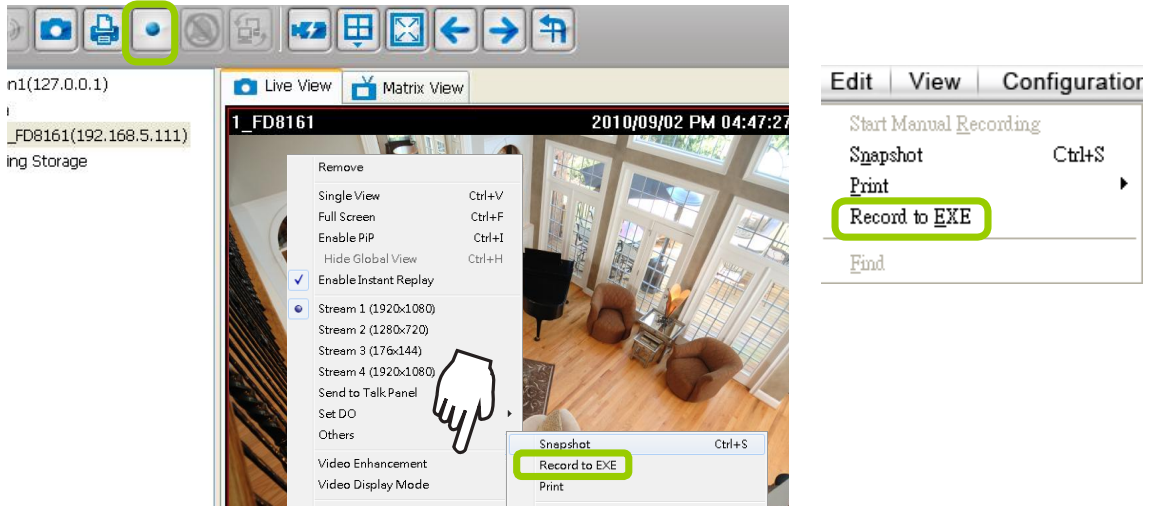

Please follow the steps below to record an EXE/3GP/AVI file of a live video stream:

- Select a video cell or a device from the hierarchical management tree which you want to record to media file.
- Click **Record to EXE/3GP/AVI**  on the quick access bar, or **right-click** the video cell and click **Record to EXE/3GP/AVI**. You can also click **Edit > Record to EXE/3GP/AVI** on the menu bar. (The UI string will change according to your Recording Settings.)



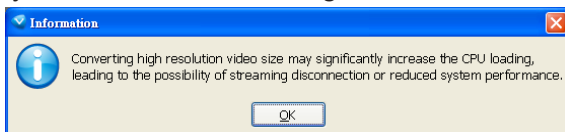

- For recording a high-resolution video (1600 x 1200) in AVI type, a dialog box will pop up as shown below to remind you that the CPU loading will increase. Click **OK** to continue the process.

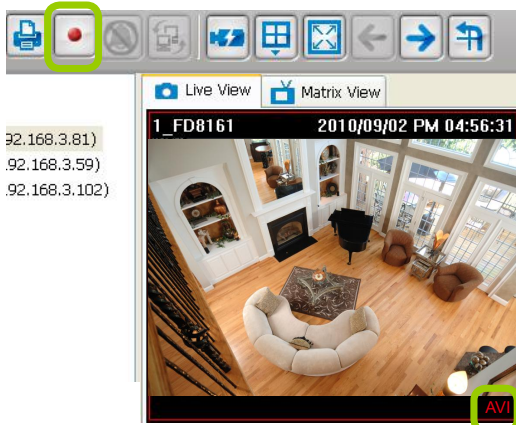

- The icon  will then change to **Recording EXE/3GP/AVI** , and a red text string (**EXE/3GP/AVI**) will appear at the bottom right of the video cell. Note that only one video channel can be recorded at a time.



*If you save your video via a LiveClient installed on another computer, the videos will be placed in where you installed the LiveClient utility: e.g., C:\I VAST\Client\LiveClient\Record. On Windows XP: C:\Documents and Settings\All Users\Documents\ VIVOTEK Inc\ VAST\Client\LiveClient\Record*

- When you want to terminate the AVI Recording, click the icon  on the Quick Access Bar. The export process will then terminate and the button will change from  to . The recorded media files will be found in the preset storage folder on your local computer as shown below.

Below is the file name format for AVI files:

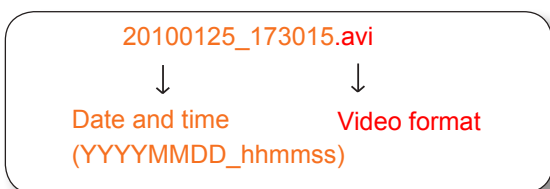



## Built-in Media Player--EXE

Below is the icon of footages saved as EXE files. Double-click on it, the recorded video will be played automatically as shown below. You may also open the built-in Media Player in the default location: C:\Program Files\VIVOTEK Inc\VAST\Client\LiveClient. On Windows XP: C:\Documents and Settings\All Users\Documents\VIVOTEK Inc\VAST\Client\LiveClient\Record.

Video Title

20091118\_112743.exe  
MediaPlayer Application

IP8172

Timeline Slider

2013-04-01 08:49:13

2013-04-01 08:49:45

Status Panel

2013/04/01 08:49:15 32 secs 1X Playing

Control Buttons

Total length of the histogram

The playing rate can be 1/8, 1/4, 1/2, 1X, 2X, 4X.

Current time of the video clip

Icon	Function	Description
	Pause	Pause playback of the focused video clip
	Play	Start playback of the focused video clip
	Next Frame	Go to the next video frame of the focused video clip
	Slow Down	Slow down the playback rate
	Speed Up	Speed up the playback rate

The function menu of the built-in media player are displayed as shown below:

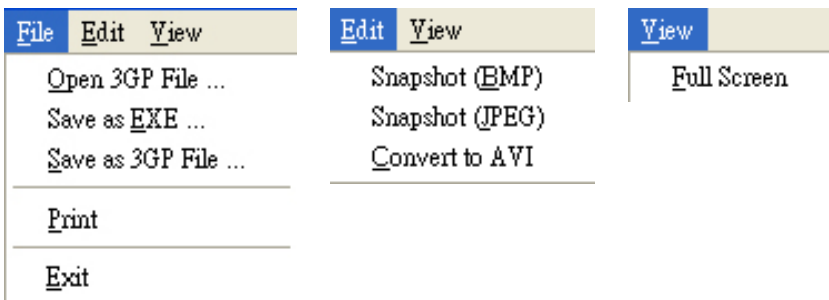

- The built-in player is able to playback 3GP and EXE files.
- The built-in player is able to save 3GP files as EXE files.
- The built-in player is able to save EXE files as 3GP files.
- The built-in player is able to convert EXE and 3GP files into AVI files.
- The built-in player also supports snapshot and print functions.



Below are special notices related to video recording with the fisheye cameras:

- For recorded videos from the fisheye cameras, only the built-in Media Player can playback the **Regional** or **Panoramic** views. If you access the recorded videos using other playback software, you will end up seeing the circular-shape Original view.
- When recording videos from fisheye cameras, Regional and Panoramic views can only be preserved in the EXE and 3GP format. If you save the dewarped views, i.e., Regional and Panoramic, as AVIs, only the circular Original view will be preserved.
- Currently the video playback on the Emap window displays the Original view only.
- To display a Regional or Panoramic view, right-click on the Media Player window.

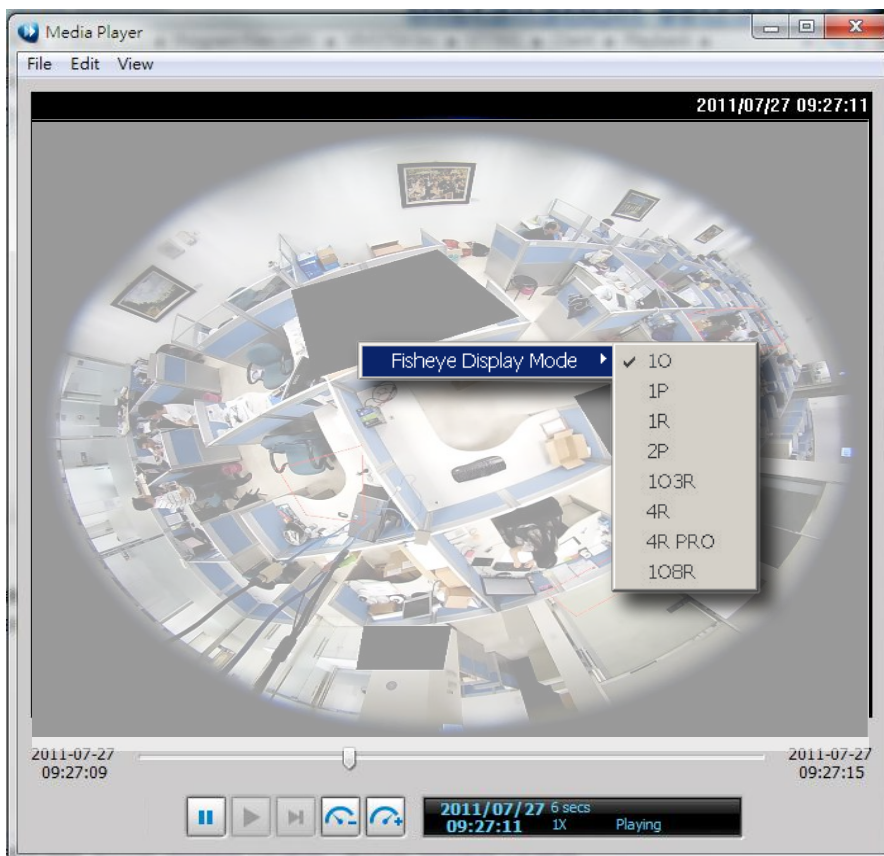

## View Settings

This section allows you to set the display mode of a video cell, including **Display Location**, **Date and time Format**, **Video Display Mode**, and **Font Settings**. When you change the settings, the sample window will change accordingly for you to preview the settings.

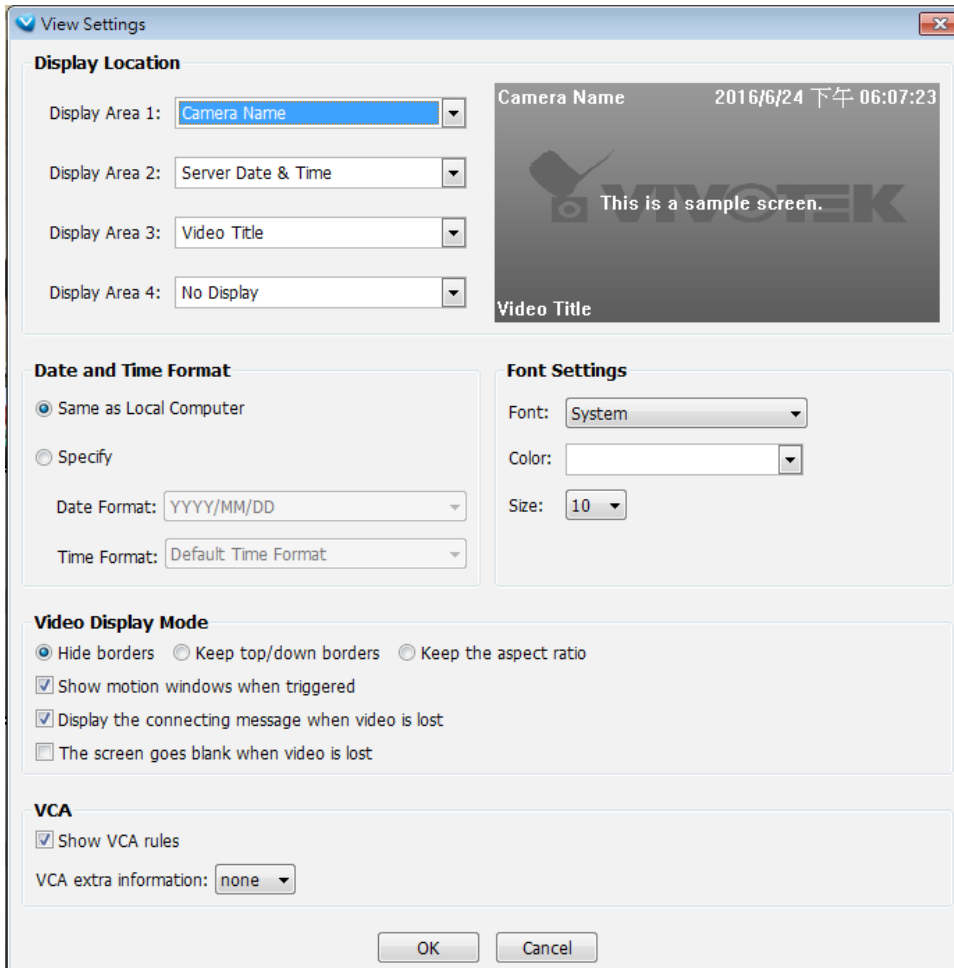

### Display Location

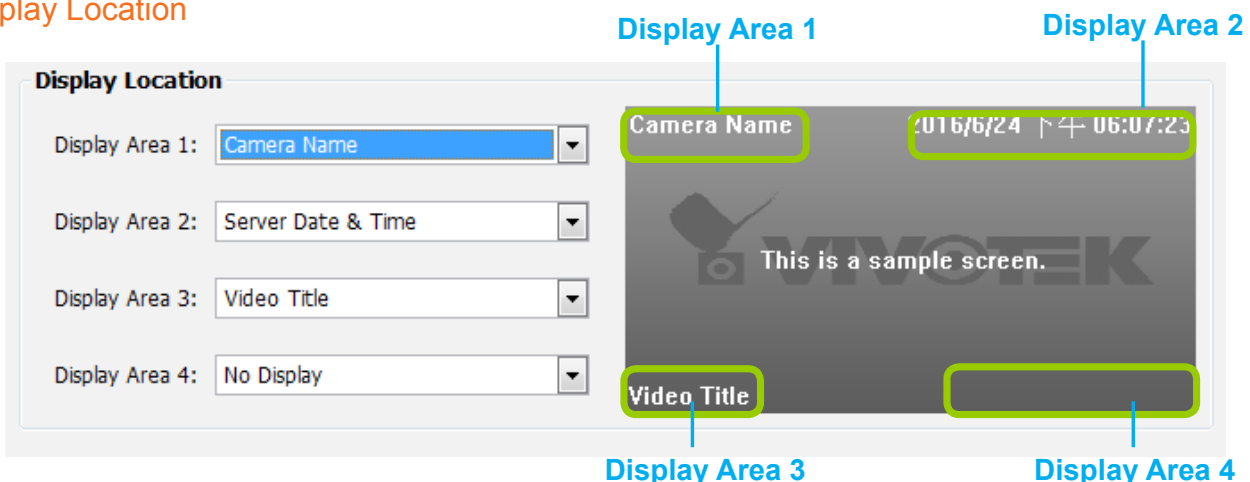

As the illustration shows, there are 4 display areas for you to input information about the live video. Each drop-down list includes many options for you to select: **No display**, **Camera Name**, **Video Title**, **Camera Date & Time**, **Camera DateTime**, **Server Date & Time**, **Codec & Resolution**, **Address**, and **Network throughput & FPS**.

## Date and Time Format

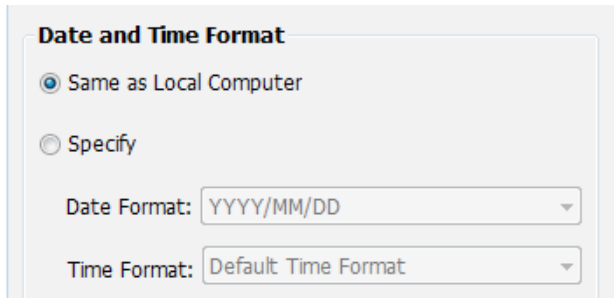

- Same as local computer: Select this option and then the date and time format will synchronize with the local computer.

- Specify: Select a desired format for the date and time from the drop-down list.

**Date format:** Select YYYY/MM/DD or MM/DD/YY.

**Time format:** Select the default time format (synchronize with the local computer), 12h AM/PM, or 24h.

## Video Display Mode

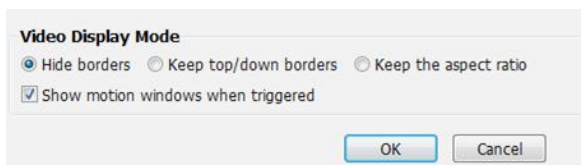

- Keep the aspect ratio: In the default settings, the size of the video window will change according to the layout of the live view window you choose. However, the frame size may be distorted.

- Keep top/down borders: the camera name, video title, and time will be displayed on the black borders instead of displaying floating text on the screen.

- Keep the aspect ratio: If you select **Keep the aspect ratio**, the video window will be adjusted to the same frame size as the preview window. This function is disabled as default.

- Show motion window when triggered: If you select this option, the red frame of the motion detection window will appear in the video window when motion is triggered. This function is enabled as default.

- Display the connecting message when video is lost:indow will appear in the video window when motion is triggered. This function is enabled as default.

- Show VCA rules: VCA rules refer to the Line Crossing and Field Detection lines drawn on individual video screens. These VCA functions are configured on the web consoles with cameras, not on the VAST LiveClient.



The Display options can also be accessed by a right-click on the view cell.

For detailed information about how to set up the layout of the live view window, please refer to **How to Change Video Viewing Mode** on page 81.

## Font Settings

This function allows you to change the font on the video cell.

- **Font:** Automatically lists all fonts installed on your operating system. Select the desired type.
- **Color:** Select a desired font color (white, red, green, blue).
- **Size:** Select a desired font size (8, 10, 12, 14).

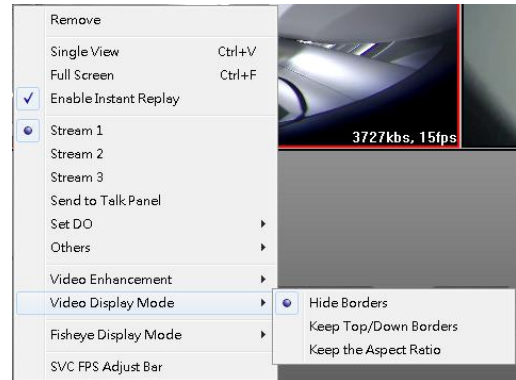
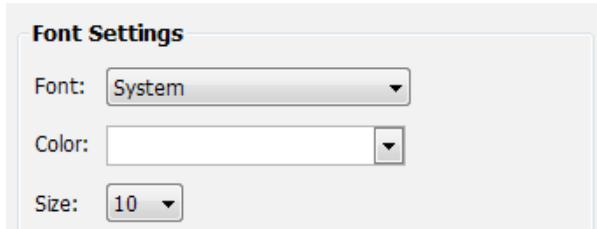

## General Settings

This section allows you to configure the **System Settings** and **Rotation Settings**.

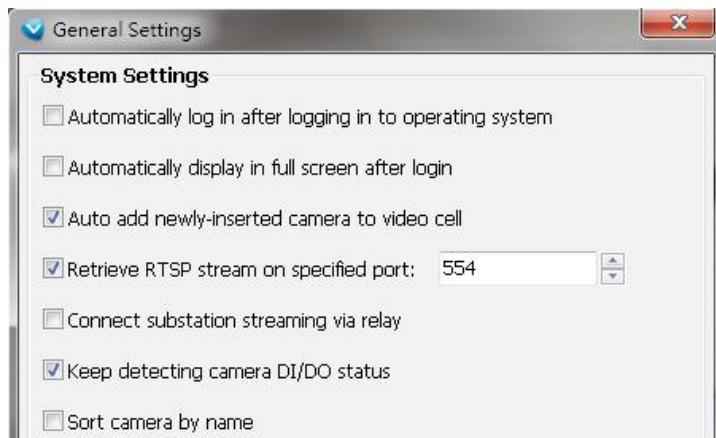

### System Settings

- Auto login after logging in to operating system: If you check this option, VAST LiveClient will automatically login after you login to Windows without filling in the user name and password. This function is disabled as default.
- Automatically display in full screen after login: If you check this option, the video cells will be displayed in full screen without showing the menu bar or the control panels.
- Auto add newly-inserted camera to video cell: If you check this option, VAST LiveClient will automatically add the newly-inserted device to a video cell. This function is enabled as default.
- Retrieve RTSP streaming on specific port: The default port for RTSP streaming is 4543. If you want to change this port, please check this item and fill in a desired port number.
- Setup substation streaming via relay: This option is not checked by default. As the following diagram shows, VAST Client might directly connect to the streaming under VAST Server 3-2 without requesting the connection via VAST Server 1 and Server 2-1. If you want to get streaming through relaying, please check this option.

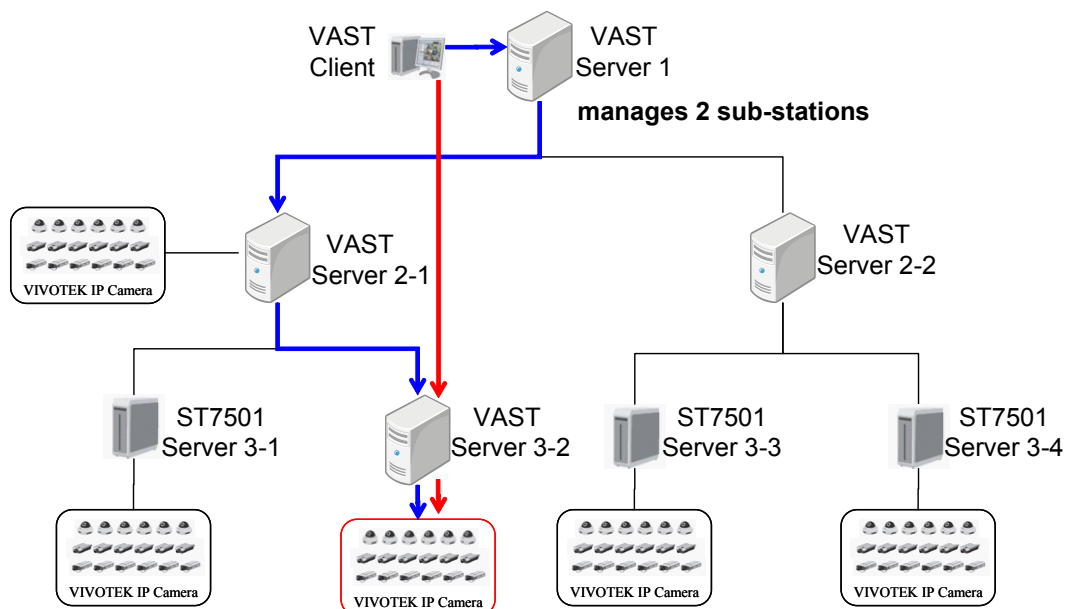

- *If the VAST Server 3-2 is set up behind a firewall, the VAST Client will not be able to access the VAST Server 3-2 directly. You have to get the connection by relaying.*

- Keep detecting camera DI/DO status: The default for this option is enabled. This option enables the VAST server to monitor the DI/DO status from the configured cameras. You may also disable this option.
- Sort camera by name: The positions of cameras on the device tree will be sorted by their camera names.

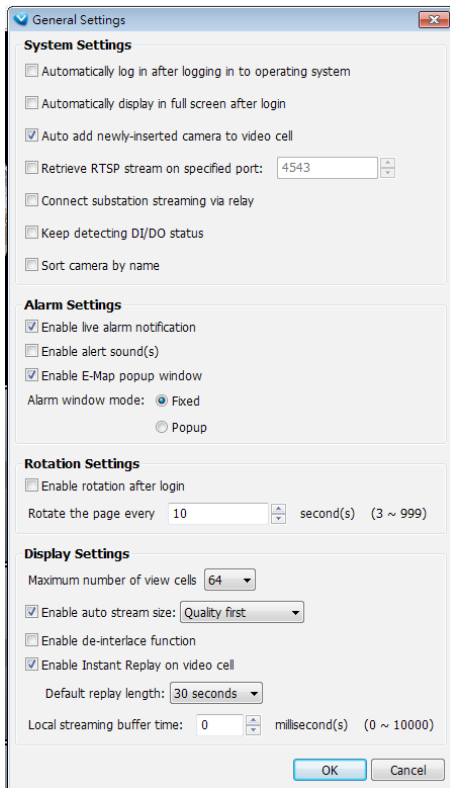

## Alarm Settings

- Enable live alarm notification: Select this option to activate real-time event notification. For example: the event notification of DI/O status on the hierarchical management tree, the event list in the event window, motion detection windows in video window, or the event notification on E-map settings page, etc. This function is enabled as default.
- Enable alert sound(s): If you enable this option, you will hear alert sound on the client side when the event is triggered.
- Enable E-Map popup window: When enabled, a popup window appears on an E-map displaying the current video when a camera-related event occurs.

Note the following with the E-Map popup window:

- The camera that triggers an alarm must be placed on the E-map to have its live video displayed in the popup window.
- When an event occurs, and the related camera is configured into multiple E-maps, the popup window appears on the first available E-map.
- When many popup windows appear, many map views will consecutively appear until all popup windows properly display.
- This feature supports popup windows for cameras under VAST substations or NVR.
- Popup windows only appear when the E-Map is opened; however, the windows will still appear on a live view.
- If a DI/DO trigger is not associated with a specific camera, no popup video window will appear when triggered.
- Fisheye dewarp is also available on the E-map popup windows.

- Please also configure the Client Notification options in the Alarm Management window.

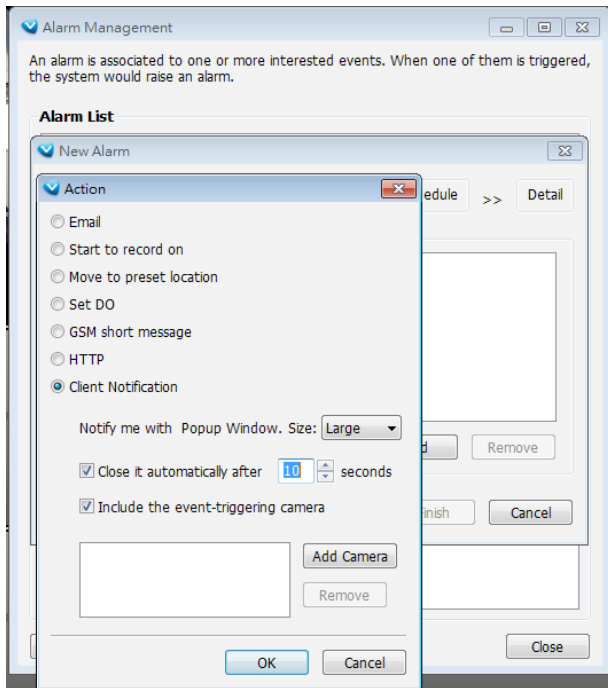

- Alarm window mode: Select **Fixed** or **Popup** mode for the event window. For more information about event window, please refer to page 39.

### Rotation Settings

- Enable rotation after login: If you check this option, the video cells will start to rotate after you login to the VAST LiveClient. The default setting of this function is disabled.
- Rotate the page every  second(s): Fill in a desired interval time for video page rotation. The maximum value is 99 seconds. The default value is set at 6 seconds.

For detailed information about how to set up the layout of the monitoring window and rotation functions, please refer to **How to Change Video Viewing Mode** on page 81.



## Display Settings

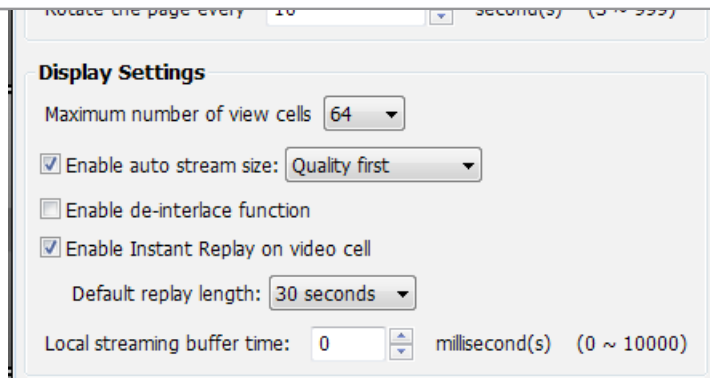

- Maximum number of view cells:** This determines the number of view cell on window, and also takes effect with the number of layout pages. For example, if there are 320 channels using the 1+31 layout, there will be 10 layout pages in the LiveClient window. The configuration changes take effect after the LiveClient is re-started.
- Enable auto stream size:** The Auto Stream Size feature dynamically adjusts the stream sizes of video feeds from network cameras in order to reduce CPU load and bandwidth consumption.

It is often the case that in surveillance deployments the physical dimensions of monitors, the effectiveness of visual stimulus, and the operators' regions of interest can all be very limited. Streaming large-size videos at all times will be a waste of bandwidth and system computing power. CIF and VGA size videos are usually sufficient for the operators watching surveillance screens.

When enabled, your LiveClient station automatically requests smaller-size streams as video feeds (any from streams #1 ~ #4) from the network cameras. For example, the frame size of video stream #4 will be reduced to 320x240 (CIF). Depending on the actual size of view cells on the LiveClient monitoring screen, the VAST server automatically requests different video streams.

When the size of view cells is manually expanded, a VAST server requests a different stream. This is called **Stream Jump**. Shown below are the details of the corresponding stream jumps.

View cell size	Stream jump to...
<b>4:3 resolutions</b>	
<= 320x240	stream #4 (CIF)
> 320x240 or 640x480	stream #1
<b>16:9 resolutions</b>	
<= 384x216	stream #4 (CIF)
> 384x216 or 640x360	stream #1
<b>1:1 (fisheye cameras)</b>	
<= 384x384	stream #4 (CIF)
> 384x384 or 640x640	stream #1

### Facts about Auto Stream Size:

- The Auto Stream Size takes effect when,
  - The size of view cell is changed.
  - Inserting a new camera, or when the "Auto add newly-inserted camera" feature is applied.
  - Double-click or click-and-drag cameras into view cells.
  - When Auto Stream Size feature is enabled (the configuration on this window).
  - Through the layout change.
- The LiveClient utility automatically adjusts stream selection according to the size of view cells, no user's configuration is required.

- The frame size of stream #1 is user-configurable. The VAST server only resizes stream #4.
- If a user disables the Auto Stream Size function later, the frame size of stream #4 will not be restored to the previous configuration. Stream jump takes place on the display of all connected cameras once the function is enabled.
- The Auto Stream Size function does not apply to the Matrix view.
- If users configured a region of interest before the Auto Stream Size function is applied, e.g., via the ePTZ control, the view cell might display a different live view.
- Below is the general rule for stream selection:

	stream # configured into VGA	stream # configured into CIF
4 streams cameras	Stream 2	Stream 4
3 streams cameras	Stream 2	Stream 3
2 streams cameras	none	Stream 2

- When a smaller stream is selected, the video quality is set to fixed quality as Good.
- The Maximum frame rate is not configured.
- The VAST server automatically selects a video resolution of a specific aspect ratio that best fits the current view cell, and places the video into the view cell.

**Limitations:**

- For older, single-stream cameras, the Auto Stream Size feature does not take effect.
- When the Auto Stream Size feature is enabled, the NR and ND series NVR configured under the VAST server will be considered as substations. The stream configuration of cameras managed by these NVR substations will not be changed. Only the video codec, bit rate, and frame rate of the video feeds directed through these NVR substations will be changed into a more economic setting.
- For the NR8401 NVR, the Auto Stream Size function may not fully apply. For cameras managed by the NR8401, the following will apply:
  - Large view cell: default viewing stream.
  - Medium view cell: stream #2.
  - Small view cell: the last stream.
- a user disables the Auto Stream Size function later, the frame size of stream #4 will not be restored to the previous configuration.

- Enable de-interlace function: Select this option if your connected device does not support de-interlace function. For example: VS7100.
- Enable Instant Replay on video cell: Here you can change the duration of a playback that happened immediately before a user utilizes the instant playback function.
- Local streaming buffer time: Video frames can be temporarily stored on the cache memory of the VAST server for a short, configurable period of time before they are displayed on the Liveview. If the networking condition is less than ideal, this can help delivering a smooth video stream. Note that this feature is not available on a Matrix view and the web console.

## Joystick Settings

This section explains how to remote control connected network devices with a USB joystick. It's easy to install and configure via the USB interface.

### Enable Joystick

Connect to the USB plug of the joystick to a USB port on your computer. Supported by the plug-in in the main page (Microsoft's DirectX), once the plug-in in the main page is loaded, it will automatically detect if there is any joystick on the computer. The joystick should work properly without installing any other driver or software.

Then you can begin to configure the joystick settings of connected devices. Please follow the instruction below to enable joystick settings.

- Select the target device from the hierarchical management tree.
- Click **Configuration > Client Settings > Joystick Settings** on the menu bar to open the **Joystick Settings** window. If your joystick is working properly, it will be displayed on the drop-down list.
- Select the joystick you want to configure. Check **Enable Joystick**, then click **Configure Buttons** to open Buttons configuration window.

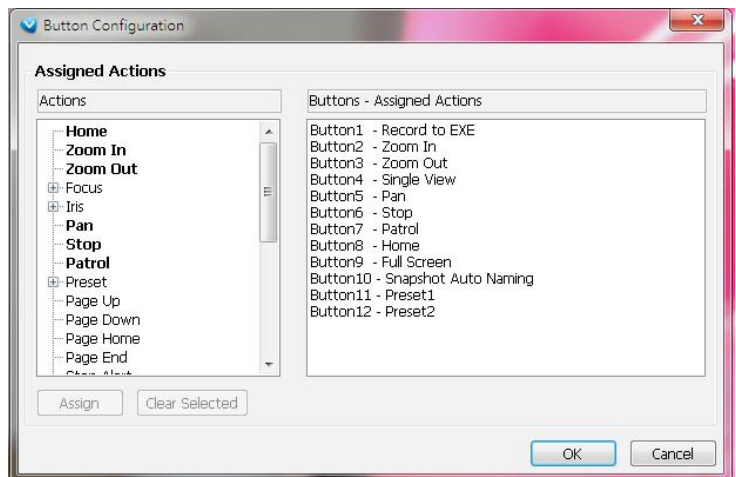
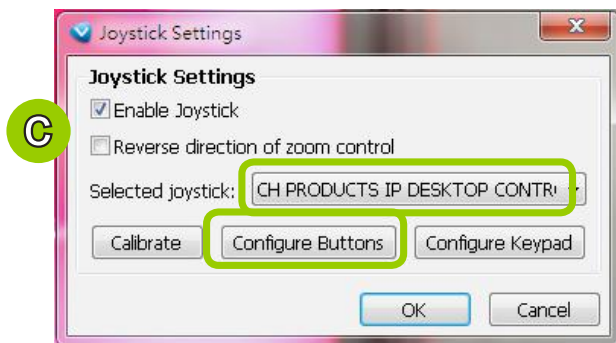
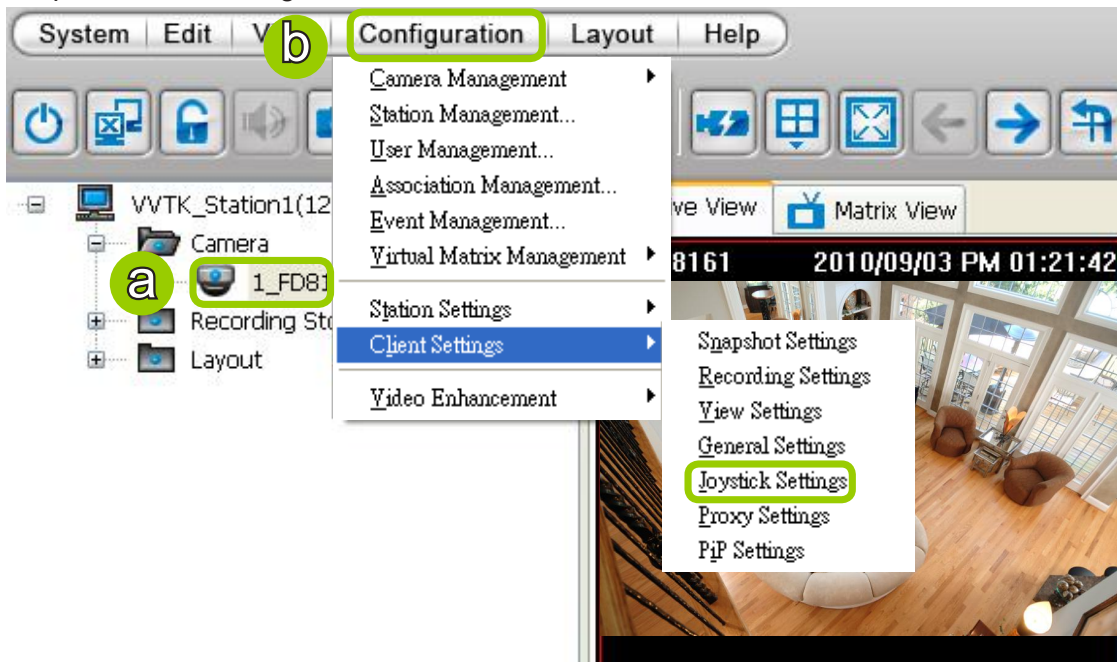

### Reverse direction of zoom control

Due to different designs in joystick zoom wheel, you can select this checkbox to reverse the zoom in/out directions.



### Buttons Configuration

In Button Configuration window, the left column shows the actions you can assign, and the right column shows the functional buttons and assigned actions. The number of buttons may differ from different joysticks.

Please follow the steps below to configure your joystick buttons:

- a. Choosing one of the actions and click **Assign** will pop up a dialog. Then you can assign this action to a button by pressing the joystick button or select it from the drop-down list.

For example: Assign **Home** (move to home position) to Button 1.

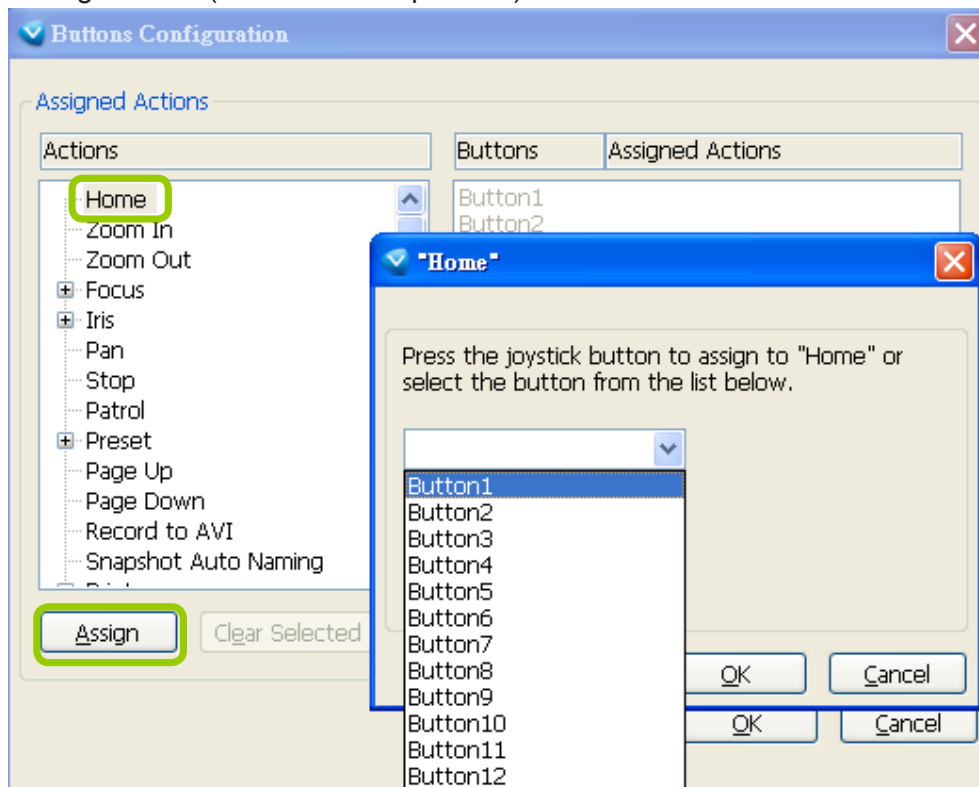

b. Click **OK** to confirm the configuration.

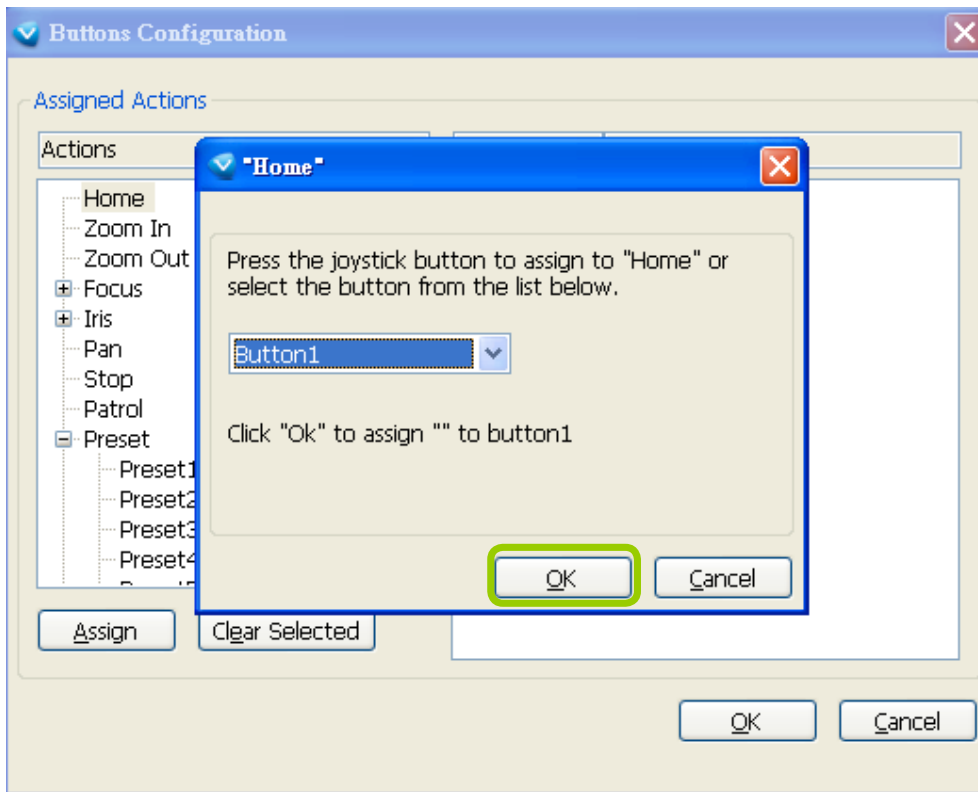

c. The Assigned Action will appear beside Button 1 in the right column as shown in the following diagram. Note that a button can only be assigned with an action. If you want to modify the settings, select the action on the list and click **Clear Selected**.

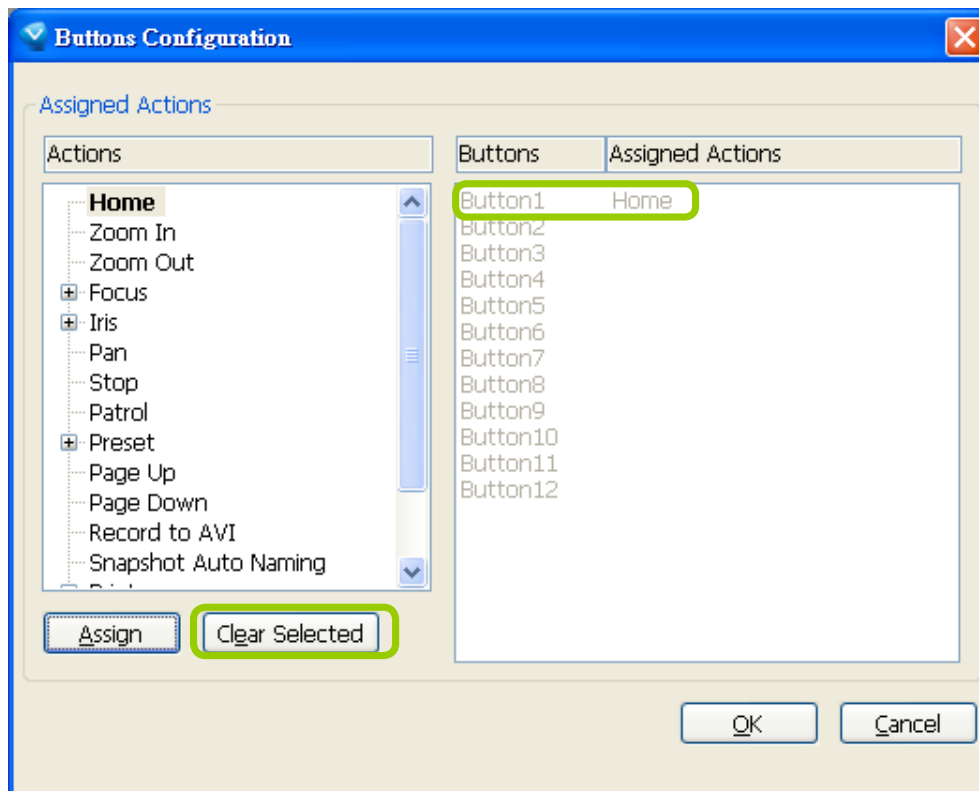

d. If you want to assign additional actions, repeat step a.~c. When all settings are complete, click **OK** to save the settings or click **Cancel** to discard the settings. You may also assign buttons to jump around matrix screens.

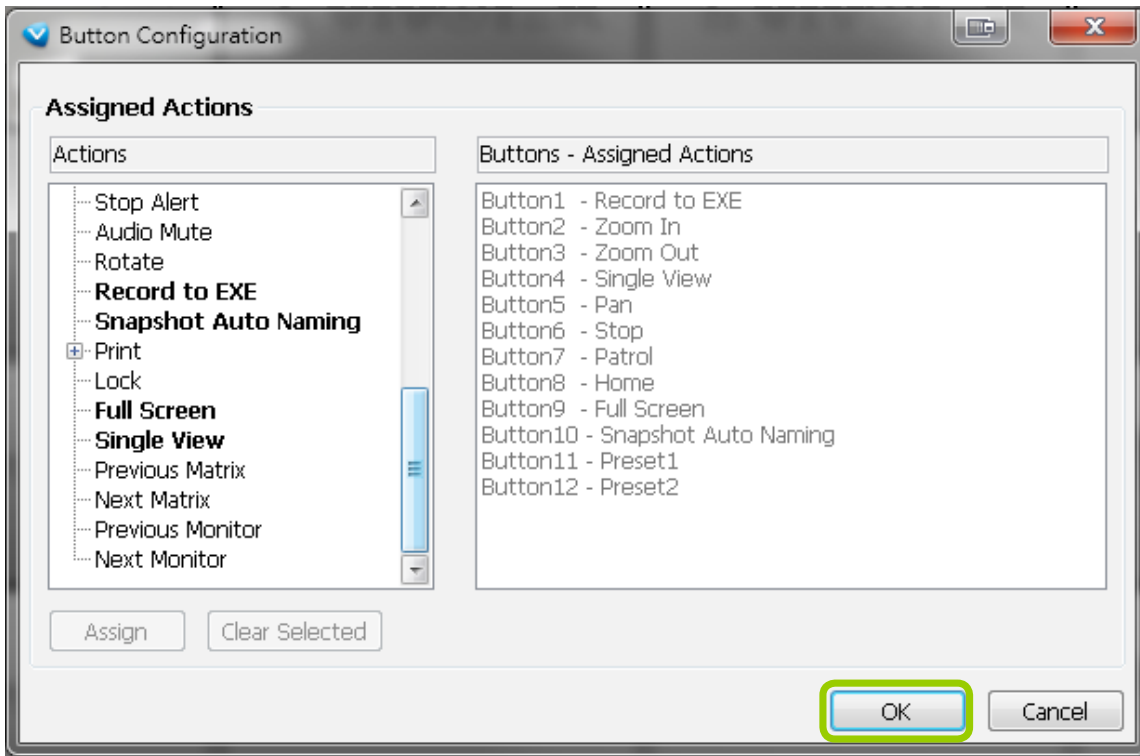

e. Click **OK** to save the settings or click **Cancel** to discard the settings.

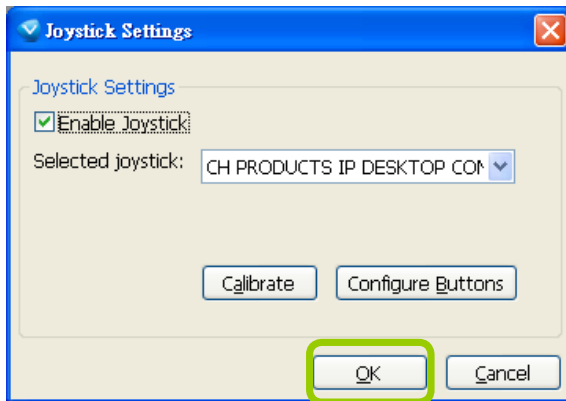



- If you want to assign Preset actions to your joystick, the preset locations should be set up in advance.
- If your joystick is not working properly, it may need to be calibrated. Click **Calibrate** to open the Game Controllers window located in the MS Windows control panel and follow the instructions for trouble shooting. For more information, please refer to the MS Windows help files for details.

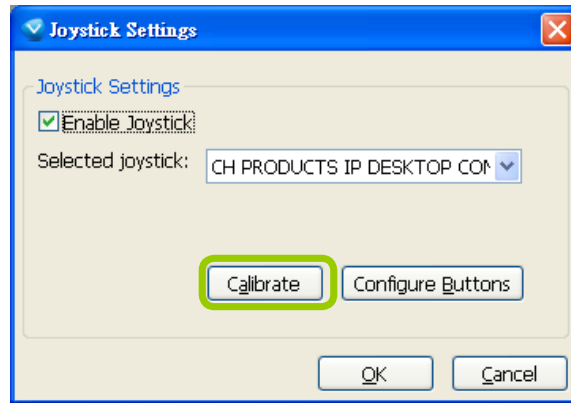

- The joystick will appear in the Game Controllers list in the Windows Control Panel on your computer. If you want to check out your device, go to the following page: Open Start > Control Panel > Game Controllers.



### Configure keypad

For joysticks that come with a keypad, you can use the combination of a number assigned to a camera and the Enter key on keypad to quickly move to the camera's current view. The current view will be displayed in a single view. To configure the number representative of each camera, double-click to open a configuration window. The number used for quick switch must be mapped to an existing channel.

Also note the following:

1. The keypad key representative can be a 4-digit numeric combination.
2. If a number key is pressed without pressing the Enter key within 3 seconds, the command is cancelled.
3. You should have at least ONE EMPTY view cell.
4. A Rotation operation will be halted when using the keypad quick switch function.
5. This quick switch function does not take effect on the cameras managed by VAST substations.

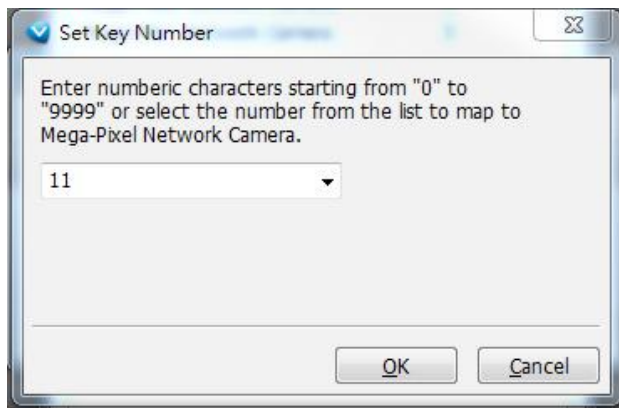
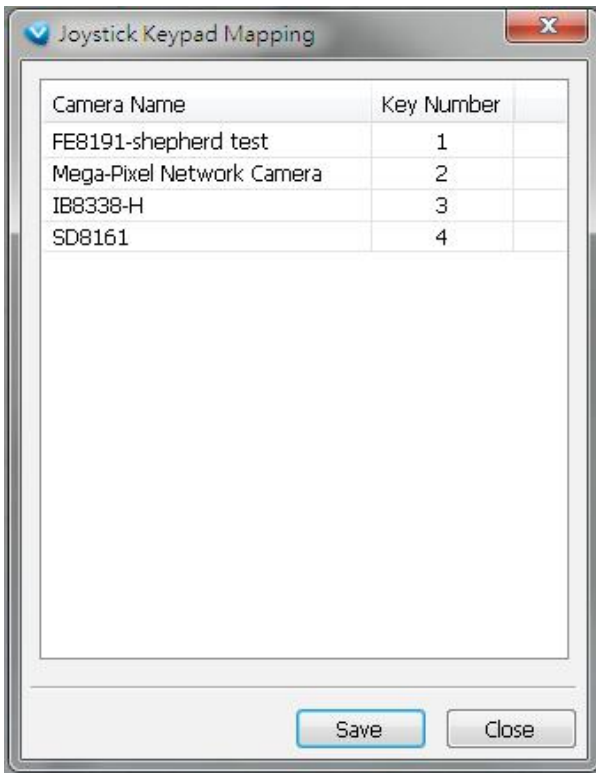



## Joystick Settings - Using VIVOTEK's AJ-001 & AJ-002

The AJ-001 and AJ-002 joysticks come with some defaults working with a VAST server.

- **Channel quick switch:** Enter 1 to 4 numbers and press “Enter” on the keypad to bring the channel into a full view. For example, enter 0010 and press Enter, CH 10 camera view will prompt on screen. Note that the number keys and Enter must be pressed within 3 seconds.
- Currently, this function does not apply to cameras managed by sub-stations.

Following are the conditions for making the connection:

1. The joystick can either be powered by a DC 12V adaptor or via the USB. If powered by USB, plug the USB cable twice to the USB port to enable USB power.
2. Connect the included USB cable between the USB ports on the joystick and a VAST server.

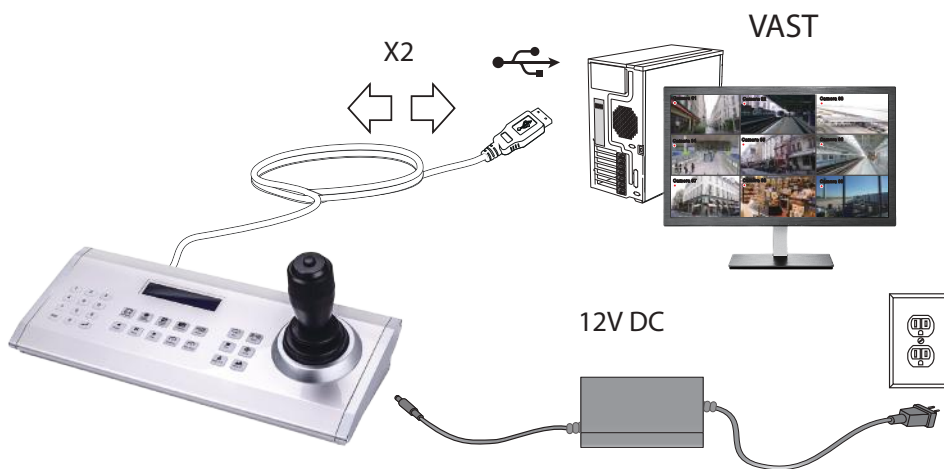

### KEYPAD DEFINITION

Below is the keypad numbering sequence:

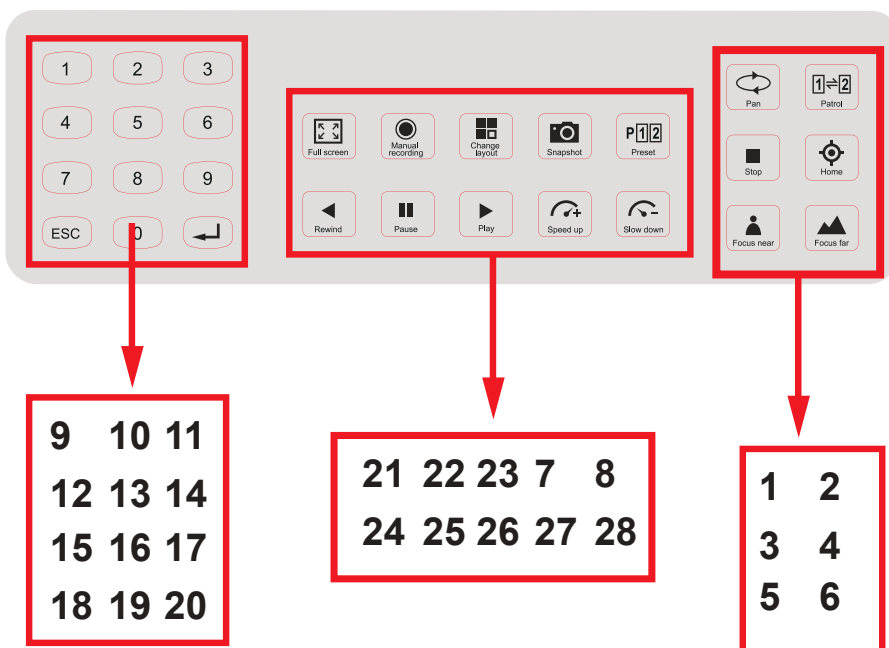

Since VAST rev. 1.13, the following keypad functions will be available as the defaults for the joystick.

1	Pan	9	#1	17	#9	25	Pause
2	Patrol	10	#2	18	Cancel/Clear/Esc	26	Play
3	Stop	11	#3	19	#0	27	Speed Up
4	Home	12	#4	20	Enter	28	Speed Down
5	Zoom in	13	#5	21	Full Screen		
6	Zoom out	14	#6	22	Manual recording		
7	Snapshot	15	#7	23	Change Layout		
8	Preset	16	#8	24	Rewind		

Use the combination of "Preset Move Combo" (button 8) + number keys + Enter. For example button 8 + 1 + 0 + Enter -> Preset #10.

- 1x1
- 2V
- 1P+2
- 3V
- 2x2
- 4V
- 2V+3
- 1+5
- 1P+6
- 3x3
- 1P+8
- 1+12
- 4x4
- 5x5
- 1+31
- 8x8

Pressing the layout button changes the current view cell layout. Press to change the layout from top to bottom as shown on the left.

You can see the default definitions for the keypad in the Joystick configuration windows.

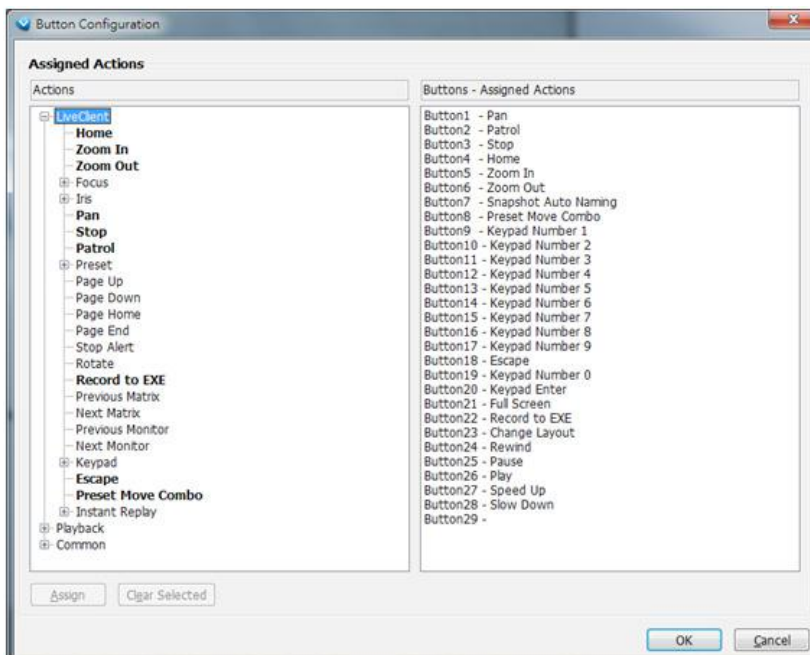

If you should need to change the mapping table, use the Keypad Mapping function.

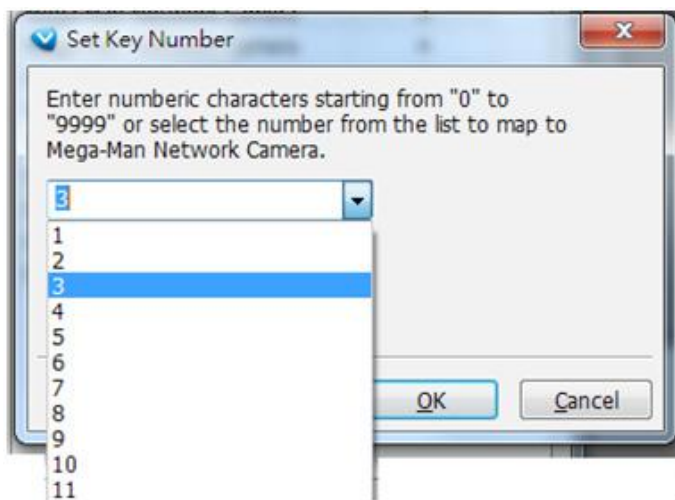
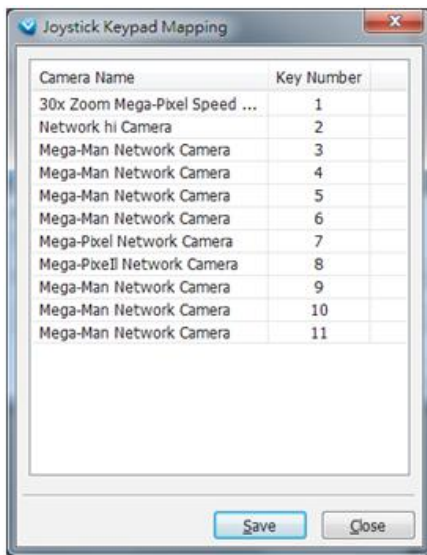

The below message shows a mapping table ID conflict.

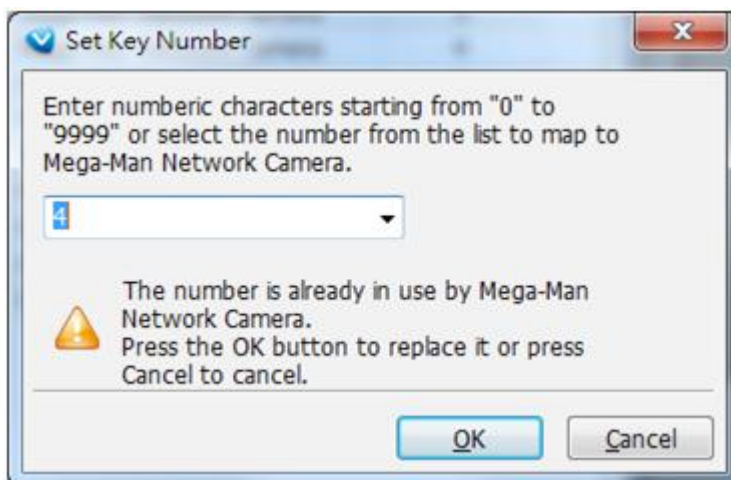

Below is the normal server status information.

User Name: 1	CPU
Station Name: VVTK_Station1	6 %
Login Time: 2015-01-19 17:21:19	Memory
Current Time: 2015-01-19 17:21:26	44 %

The capture below shows the status when using a keypad to quickly switch to a camera's live view.

Key Number: 1	CPU
Camera: IP7161	22 %
	Memory
	43 %

### PTZ/ E-PTZ Function

In addition to using the PTZ control panel, you may also control the rotation handle of the joystick to remote control a PTZ/ E-PTZ network camera with ease.

**Pan/Tilt:** Move the rotation handle of the joystick; you can pan the camera to the desire position. There will be blue line displaying the moving direction in the center of the video image as the diagram 1 below.

**Zoom in/Zoom out:** Shift the rotation handle clockwise to zoom in the camera on an image or go counterclockwise to zoom out the camera on an image. There will be a circle and four vectors in the center of the video image as the diagram 2, 3 below.



Pan/Tilt  
(Move the rotating handle back and forth)

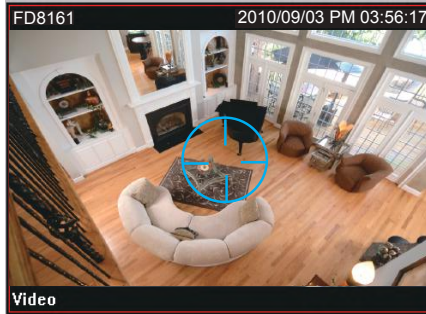

Zoom in  
(Turn the rotating handle clockwise)

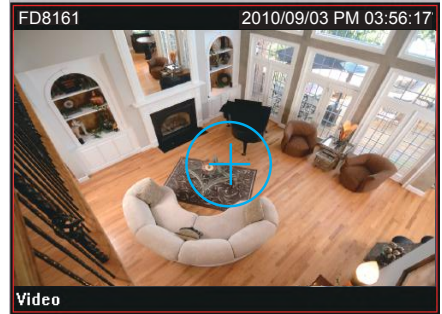

Zoom out  
(Turn the rotating handle counter-clockwise)

### Proxy Settings

In this section, you can enable, modify, or cancel **Proxy Settings** for client if your VAST Server is under a proxy. If you change the proxy settings, please fill in the new value next time you login the LiveClient next time.

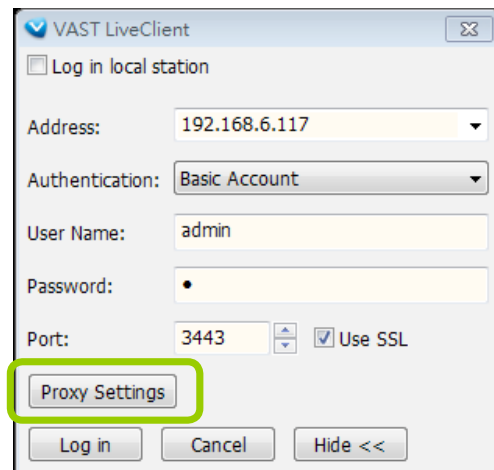
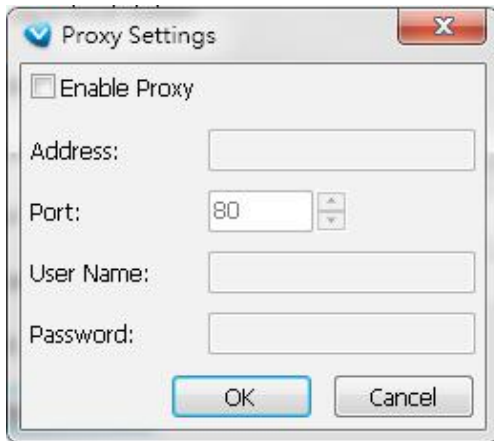

## How to Use PiP (Picture-in-Picture)

PiP (Picture-in-Picture) is an intuitive function for user to simultaneously view a Global View and ROI (Region of Interest) for live monitoring. The digital zoom in function can only focus on the interested area and represent the details of megapixel video. Moreover, the multi-touch mode is a very user-friendly interface for digital zoom in.

### Enable PiP

**Right-click** the video cell and select **Enable PiP**. If you want to disable PiP, click the option again to uncheck it. After you enable the PiP function, a movable global view window and a ROI frame will be displayed as shown below.

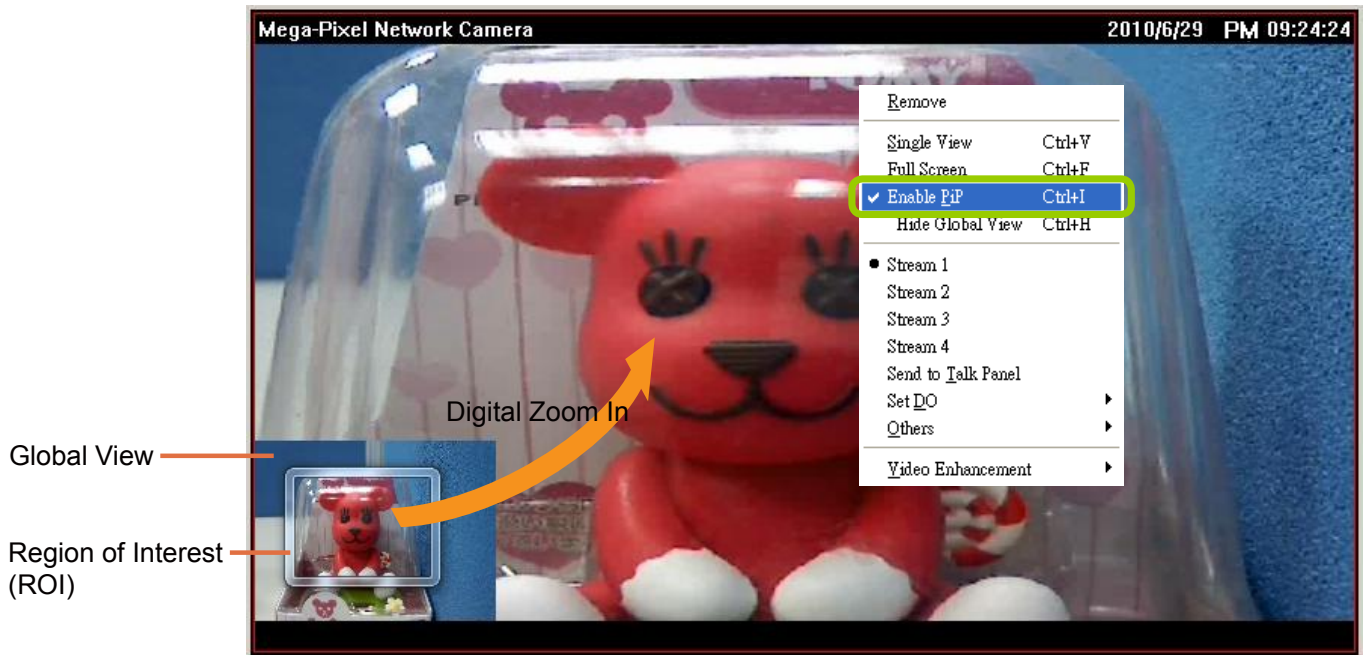

### Global View

The global view is the original view with the size scaled down to 160x120. It is movable and you can drag it anywhere in the live view window. If you want to hide the global view, **right-click** the video cell and select **Hide Global View** from the menu. An icon  will appear on top of the live view window.

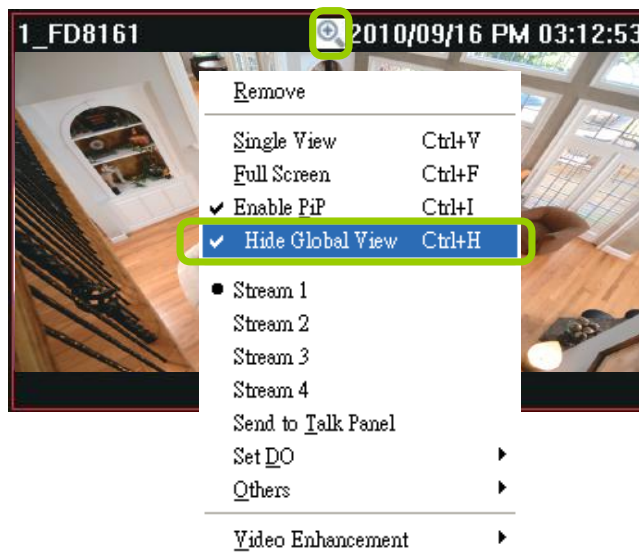

## ROI (Region of Interest)

The ROI frame is capable of being resized and dragged in any direction upon the global view window as e-PTZ function.

## Digital Zoom In

Through digital zoom in, the live view window will be filled with the zoomed in ROI image. The maximum magnification of the ROI frame is 16x zooming. The zoomed in area will change as the ROI frame is dragged and resized. You can also easily zoom in and zoom out the ROI frame by rolling the mouse back and force.

## Snapshot & Print Zoomed In Image

You can snapshot and print the zoomed in image.

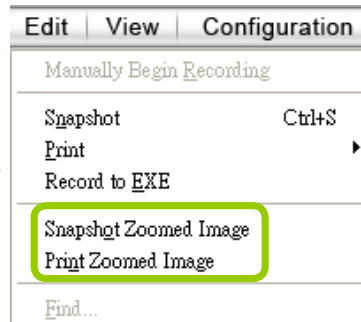

## PiP Settings

The PiP Settings is for you to adjust the initial position of the global view window.

Click **Configuration > Client Settings > PiP Settings** to open the window. On top of it, you may choose the horizontal position with left / middle / right side of the live view window, or you can customize the percentage of space distance from the border of the live view window as an option. It is also fully applied for vertical position with top / middle / bottom side of the live view window. When it's done, you may click on **Apply to existing windows** to enable the settings.

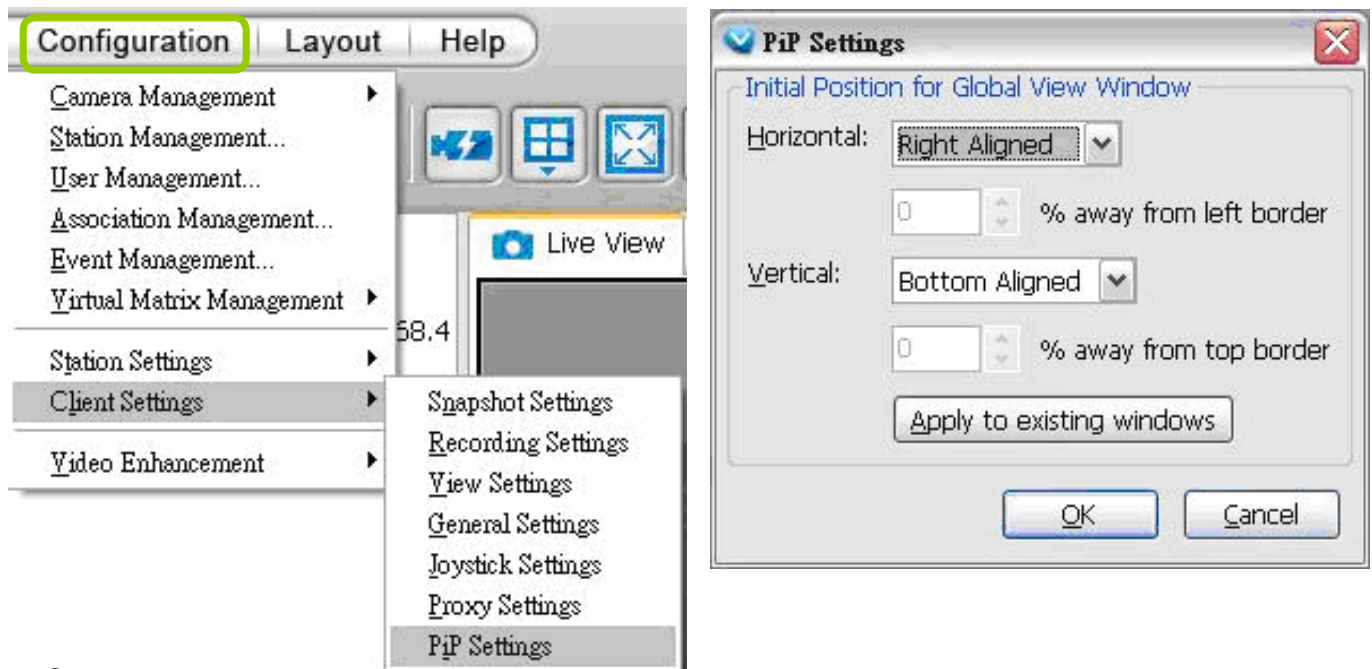

- If the position of ROI and global view will be saved and applied for the next open. It will be removed when the live view cell is removed.
- The PiP function is also applied in VAST Playback.

### Multi-touch Mode

VAST also supports advanced multi-touch mode for PiP. You can easily zoom in or zoom out the image by touching the multi-touch monitor with two fingers.

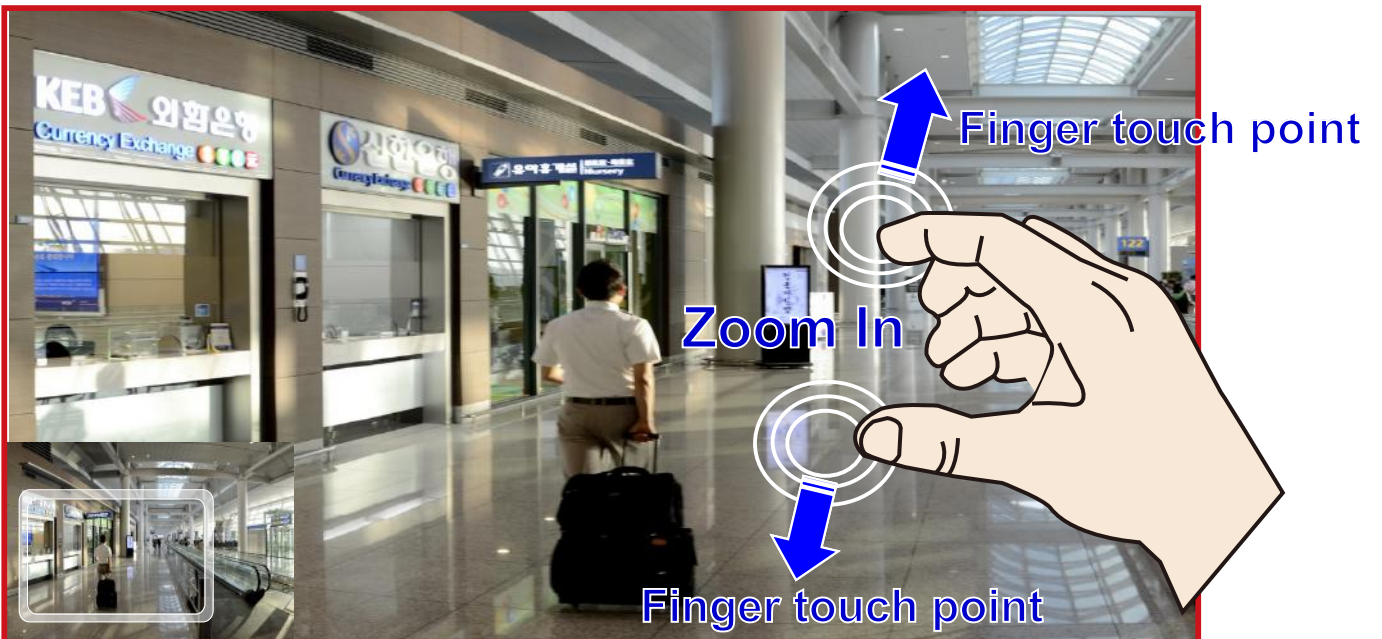
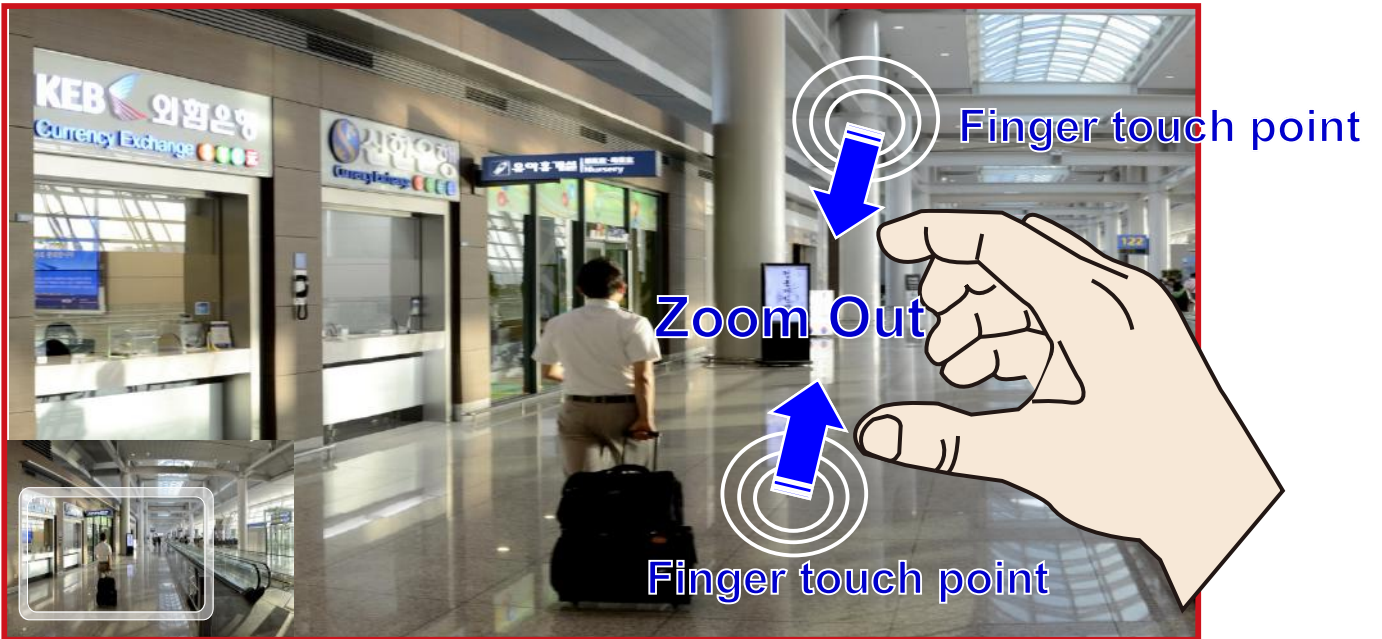



## How to Configure Video Enhancement

The LiveClient allows you to enable post-image enhancement and defog for video live view.

### Basic Image Adjustment

This function allows you to configure basic image adjustment including Brightness, Contrast, Saturation, and Hue.

Please follow the steps below to set a profile for post-image adjustment settings:

- Select the target video cell.
- Click **Configuration > Video Enhancement > Basic Image Adjustment > Settings** on the menu bar to open the **Profile Settings** window. (Or you can **right-click** the video cell and select **Video Enhancement > Basic Image Adjustment > Settings** from the popup menu.)

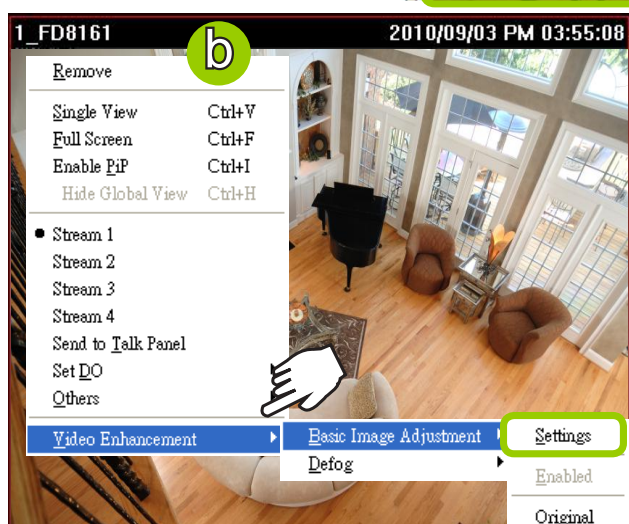
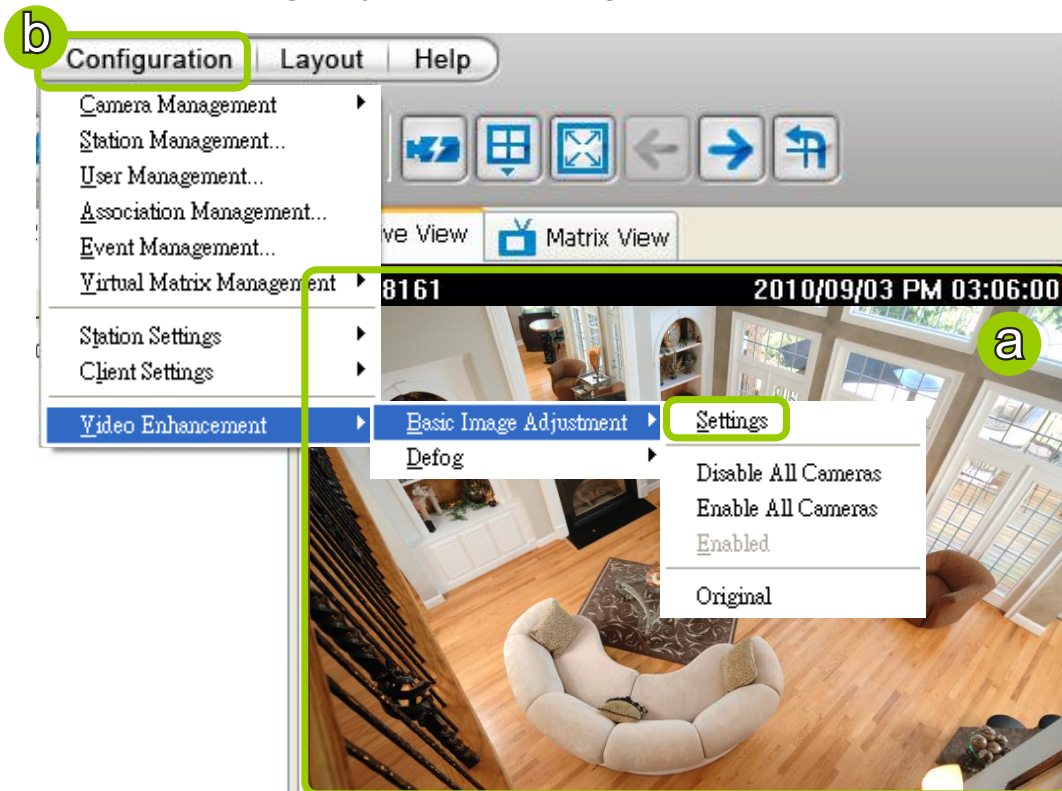

- Adjust the values of Brightness, Contrast, Saturation, and Hue. You can preview the image from the window on the right. A "VE (Video Enhancement)" text string will appear at the bottom right of the preview window.
- When completed, click **Save as Profile** and enter a name for the new profile.
- The new profile will be displayed on the drop-down list. This profile can be applied to all video cells.
- If you decide to apply the selected profile to the target video cell immediately, click the **OK** button. Otherwise, click **Cancel** to close the window.

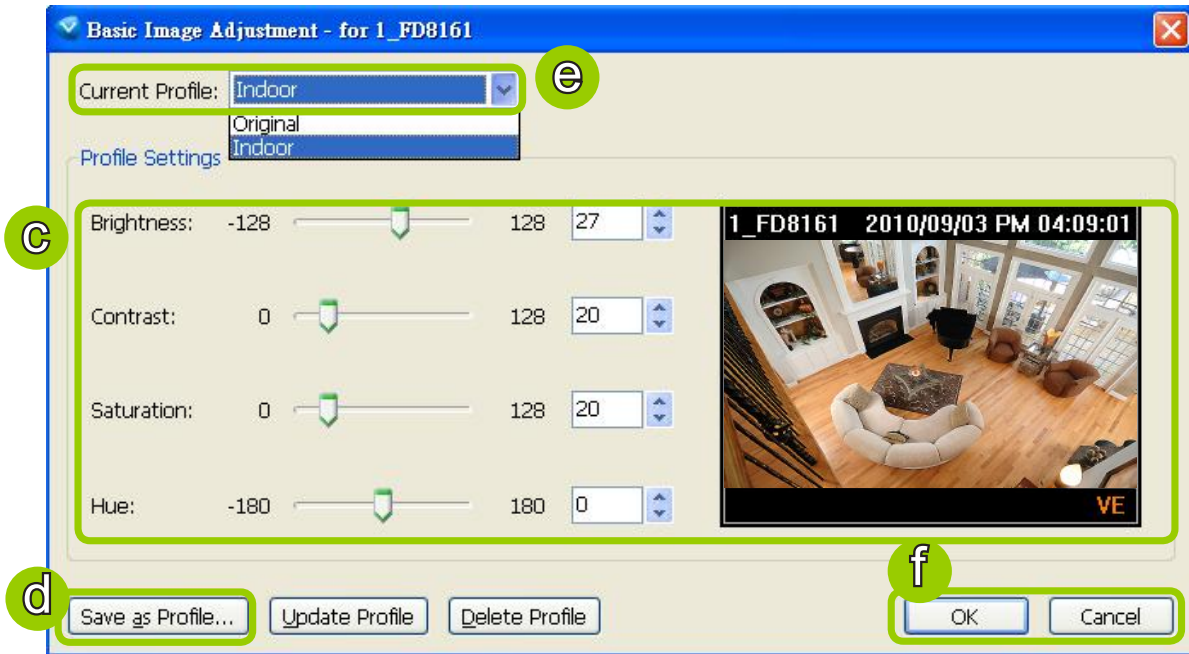

g. Back to the main page, a “VE” text string will also appear at the bottom right of the video cell and the new profile will also appear and be selected on the popup menu as shown below.

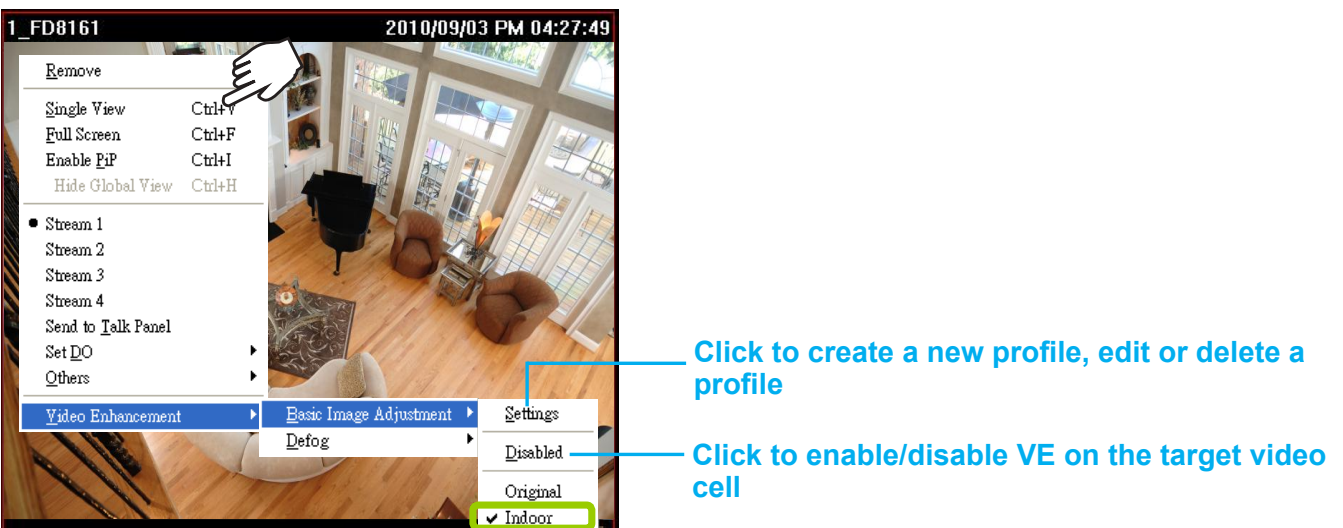
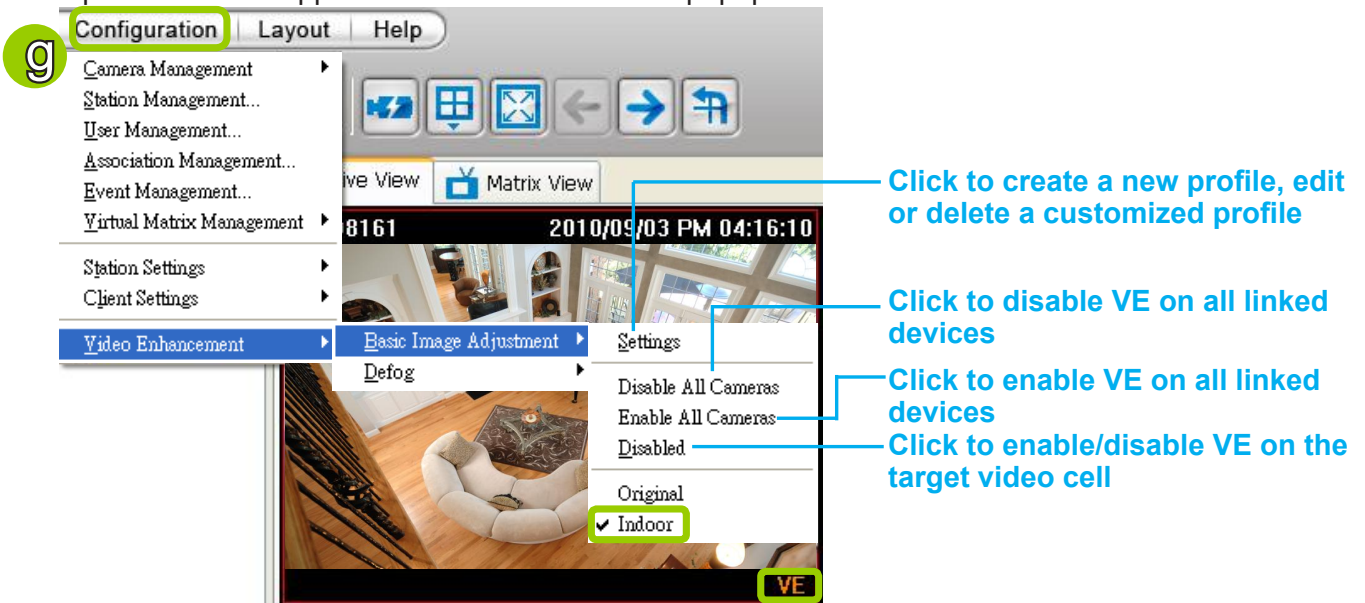

## Defog

This function allows you to configure post-image defog.

### Apply a Preset Defog Profile

Please follow the steps below to set post-image defog settings:

- a. Select the target video cell.
- b. Click **Configuration > Video Enhancement > Defog** or right-click the video cell and select **Video Enhancement > Defog**.
- c. There are some preset profiles for you to apply to the target video cell. You can select one from the list according to the environment.

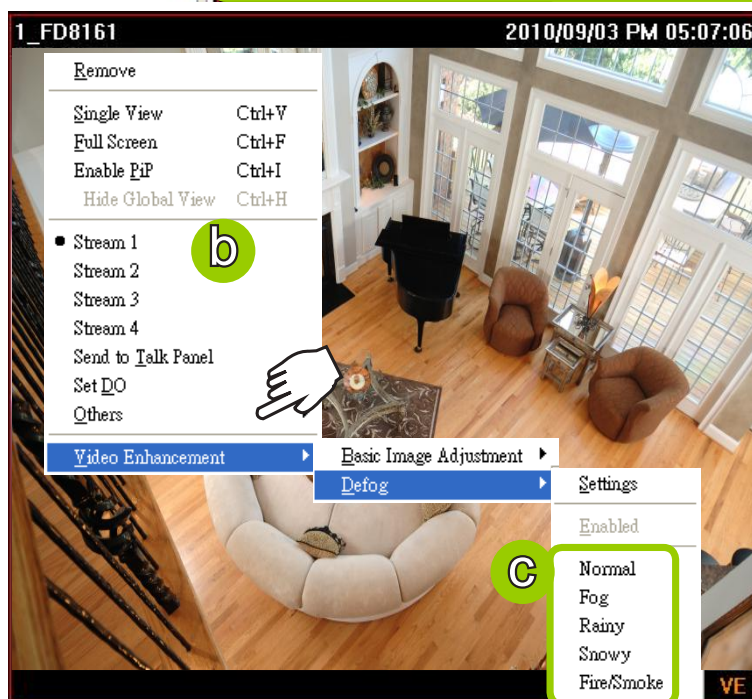
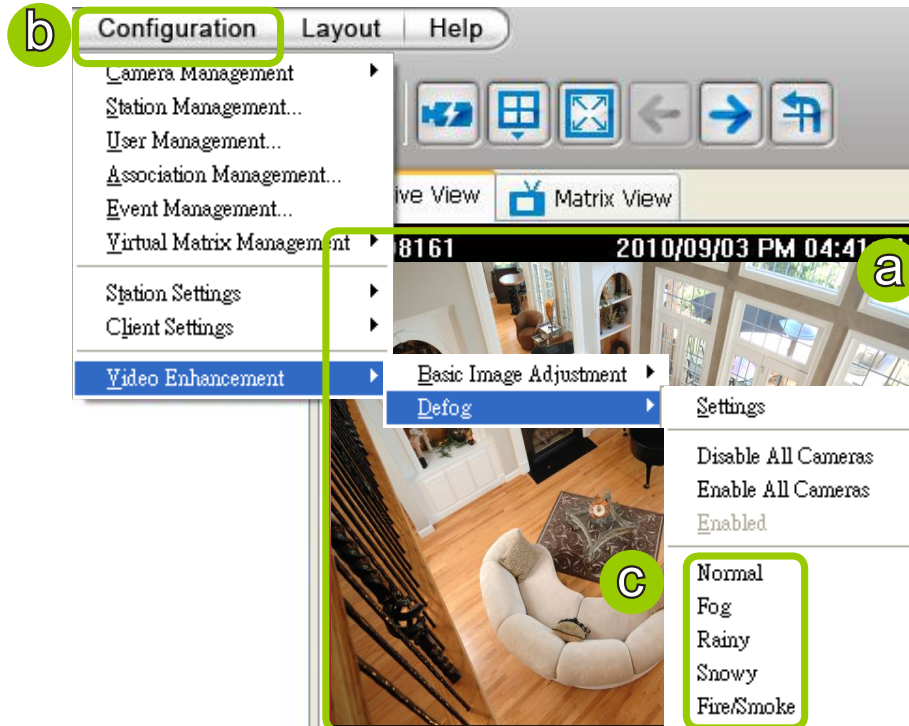

d. The string of the selected profile will be selected as shown below. A “VE” text string will also appear at the bottom right of the video cell.

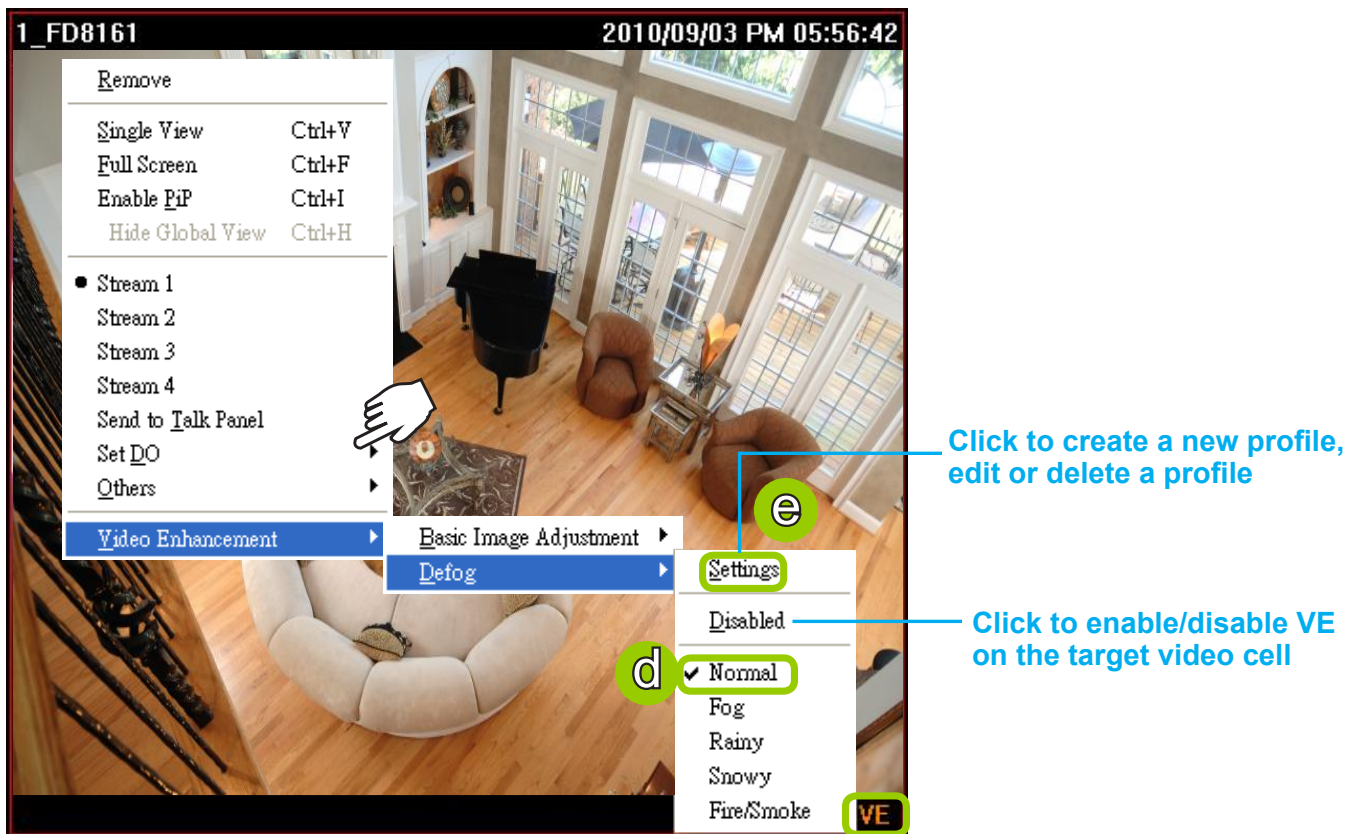
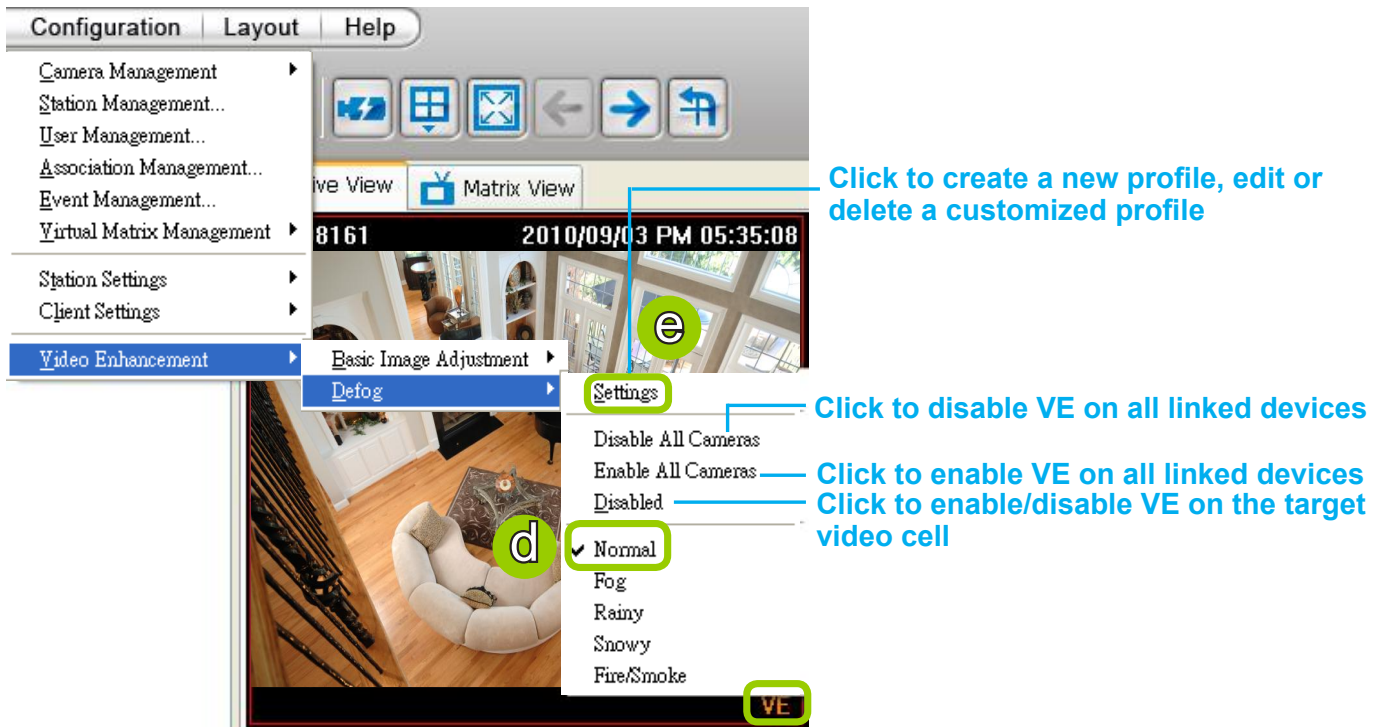

### Create a New Defog Profile

e. Click **Settings** on the popup menu to open the **Profile Settings** window.

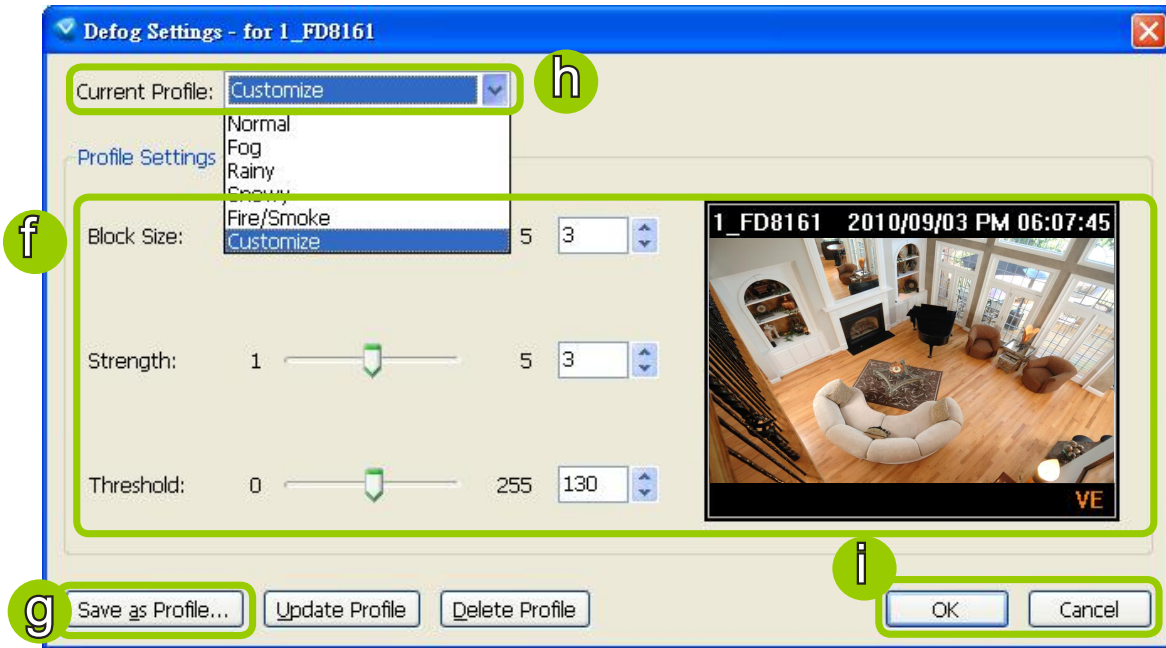

f. Adjust the values of Block Size, Strength, and Threshold. You can preview the image from the right window. A “VE (Video Enhancement)” text string will also appear at the bottom right of the preview window.

Block Size: Brush diameter from thick to thin (Value 1~5)

Strength: Brush stroke from soft to strong (Value 1~5)

Threshold: Brush pixel from loose to dense (Value 0~225)

g. When completed, click **Save as Profile** and enter a name for the new profile.

h. The new profile will be displayed on the drop-down list. This profile can be applied to all video cells.

i. If you decide to apply the selected profile to the target video cell immediately, click the **OK** button. Otherwise, click **Cancel** to close the window.

## How to Search for a Device on the Hierarchical Management Tree

This function allows you to conveniently search for an inserted device, which is useful when many devices have been inserted.

Please follow the steps below to find a device on the camera list:

- a. Click the station on the hierarchical management tree.
- b. Click **Edit > Find** on the menu bar (or **right-click** the station and click **Find**).

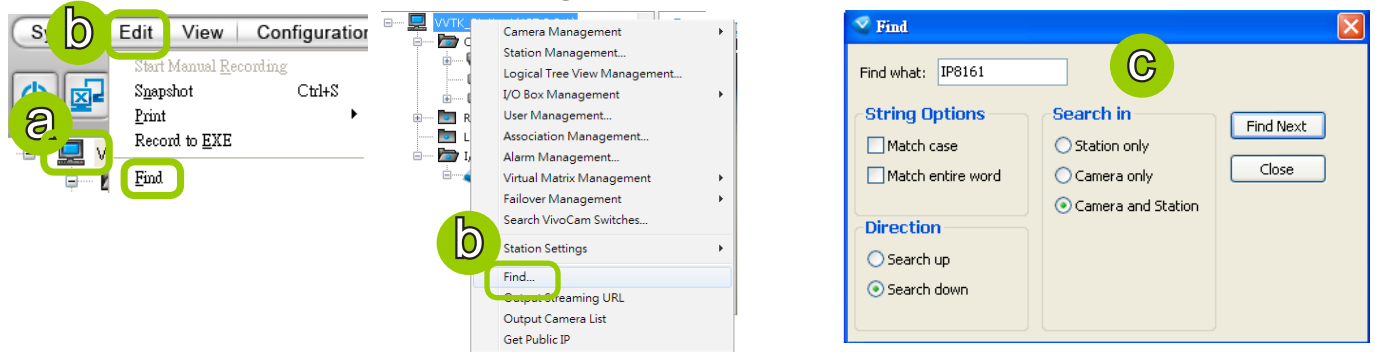

- c. The **Find** window will pop up for you to set your search criteria.

- Find what: Enter a string in the blank. The string can be the full or partial name of the device you want to search for.
- String Options: **Match case** represents that the search results should be identical to the string in lower-case or upper-case letters, the string can be part of a word. **Match whole word** means that the search results should be identical to the string for every character, and that the string should be a complete word or phrase. If you select both options, the search results should conform to all criteria listed above.
- Direction: Select **search up** or **search down**.
- Search in: Select **search in station or camera**.

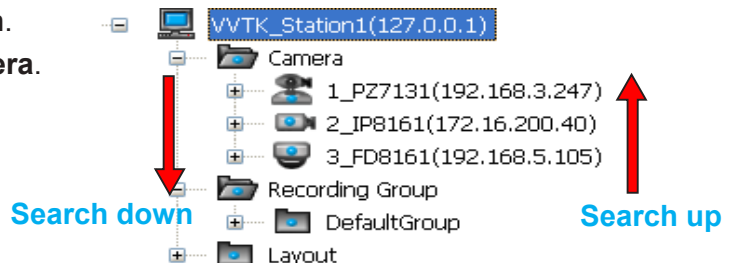

- d. Click **Find Next**, the searching result will be marked as shown below.

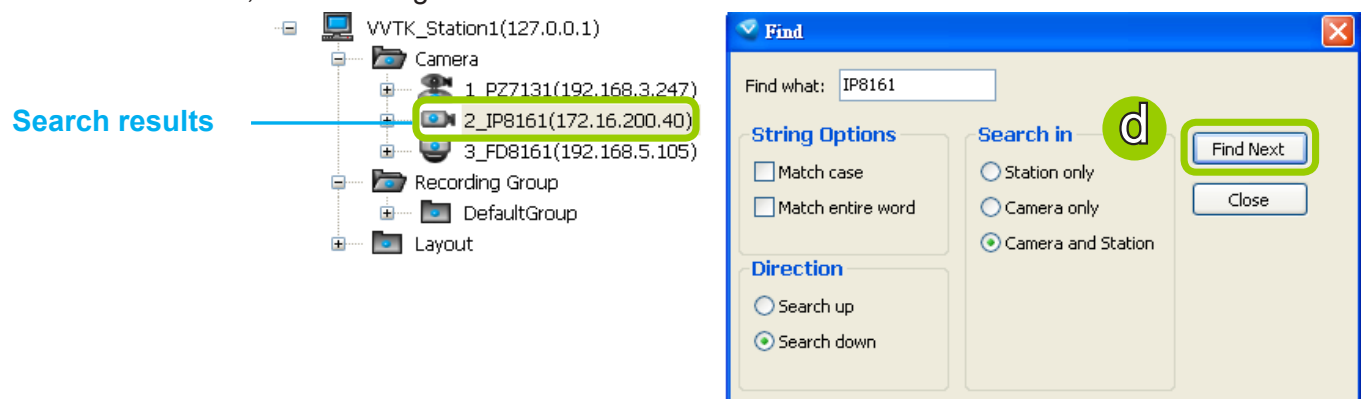

- e. If there is nothing found in the camera list, a message will pop up as shown below:

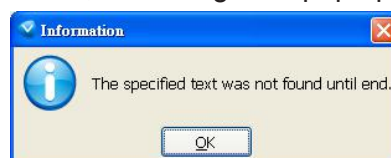

## How to Print a Video Image

There are two ways to print out an image of live video:

1. Select a video cell, then click **Print**  on the quick access bar, or **right-click** the video cell and select **Print** from the popup menu. A Print window will pop up for you to choose the printer.

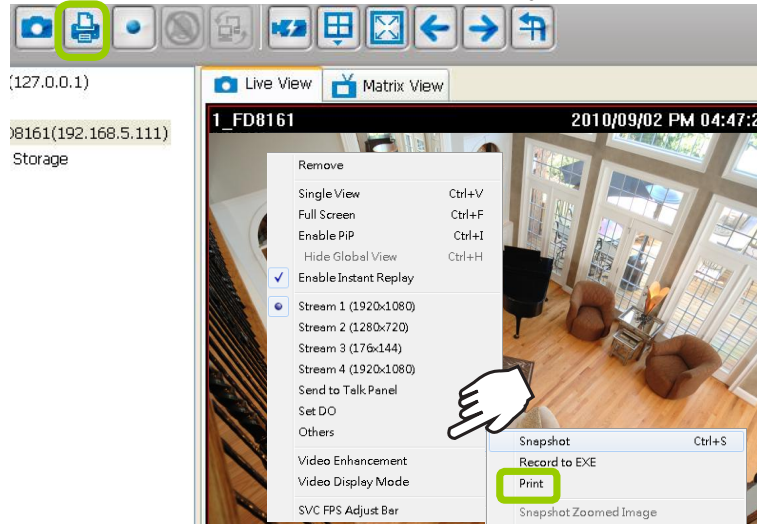

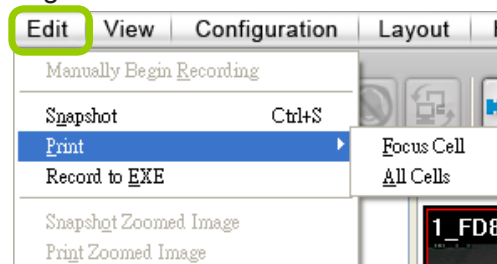

2. You can also click **Edit > Print** to print out an image from a video.

- Focus Cell: Print out an image of the target video.
- All Cells: Print out an image with all video cells in the monitoring window.



## How to Lock LiveClient for Security Concerns

If you are away from your computer, for security reasons, we suggest you lock the program. When LiveClient is locked, the user must fill in the correct password to unlock and access the program again.

- To lock LiveClient, click **Unlock**  on the quick access bar or click **System > Lock** on the system menu. The **Unlock**  icon will then turn into **Lock** .
- To unlock LiveClient, fill in the correct password in the popup window.

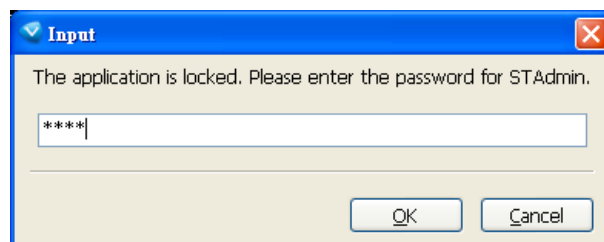
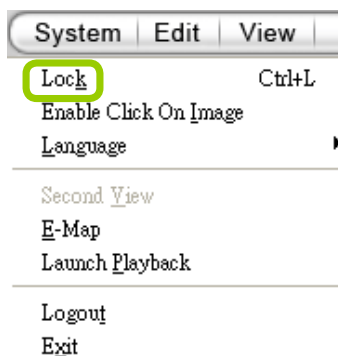

## How to Log out from the VAST Server

To logout from the current server, click **Logout**  on the quick access bar or click **System > Logout** on the menu bar. A confirmation window will pop up. Click **OK** to confirm or **Cancel** to return to the VAST LiveClient window.

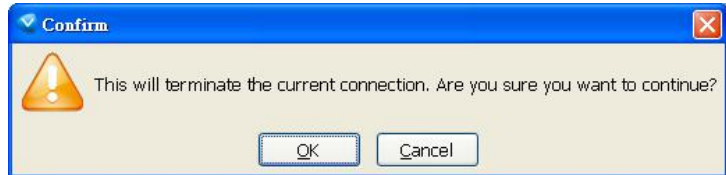
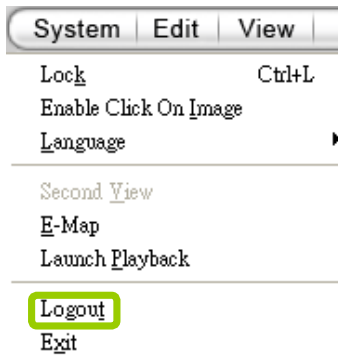

## How to Exit VAST LiveClient

To exit VAST LiveClient, click **Exit**  on the quick access bar or click **System > Exit** on the menu bar. A confirmation window will pop up. Click **OK** to confirm or **Cancel** to return to the VAST LiveClient window. When you exit the program, your user account will be automatically logged out from the current server.

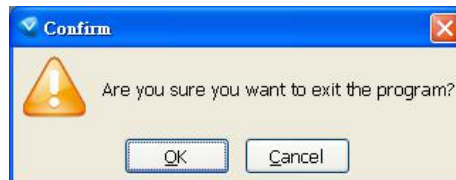
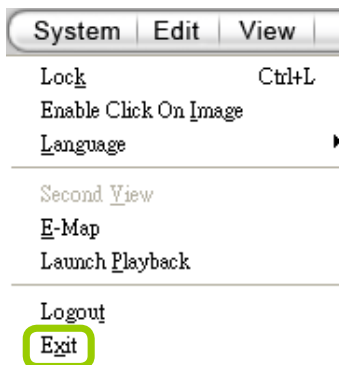



## How to Configure a Logical Tree

A Logical Tree view is available since rev. 1.10 for both LiveClient and Playback. The Logical Tree view allows you to re-define the logical relationships between the real-world deployment and the physical devices (cameras). For example, according to your deployments, you can designate several cameras to be listed under a logical sub-directory named as "Building A," and the other cameras into "Building B." In this way, you can re-arrange your cameras and devices on a tree view that is geographically accurate.

In addition to this, the logical folders can also be used to create privilege groups for users with different access rights. This enables an administrator to easily and flexibly align user privileges with his camera deployments.

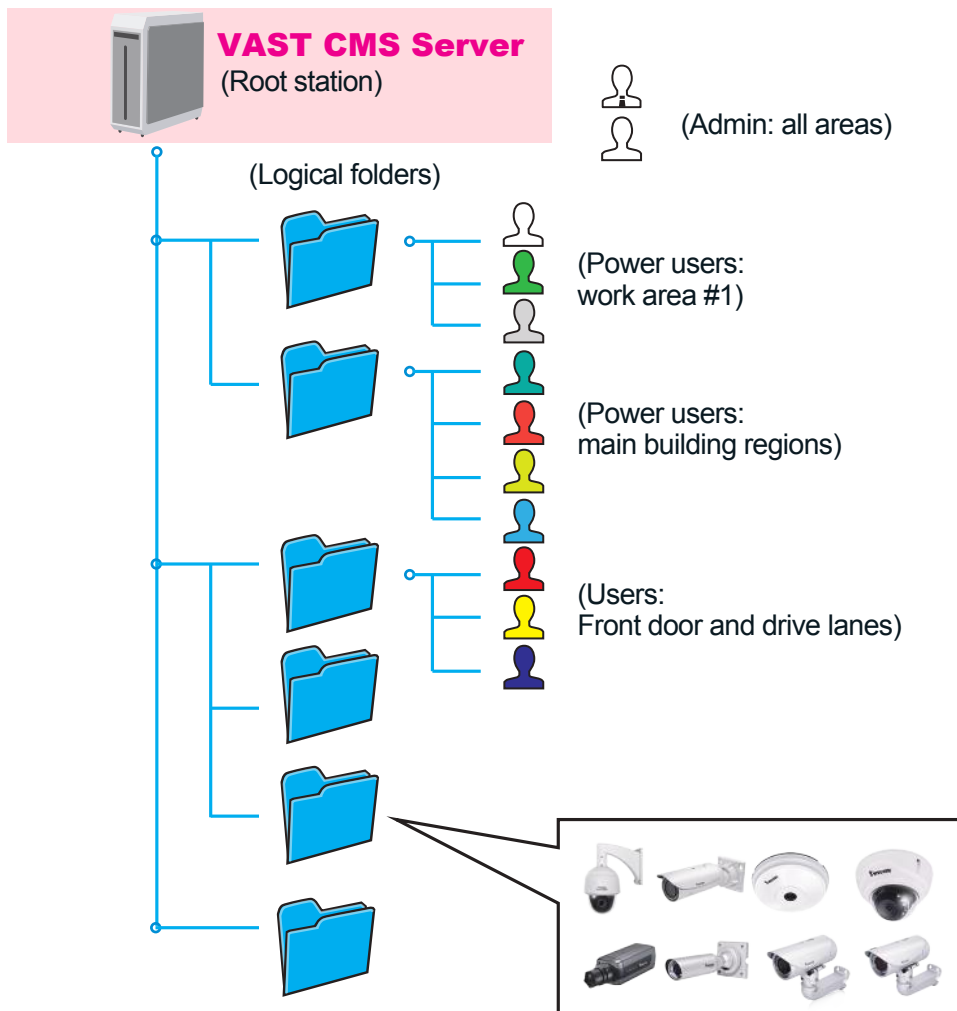

To configure a Logical Tree, either right-click on the Device list root entry (VVTk\_Station1), or visit the top menus through **Configuration > Logical Tree View management**.

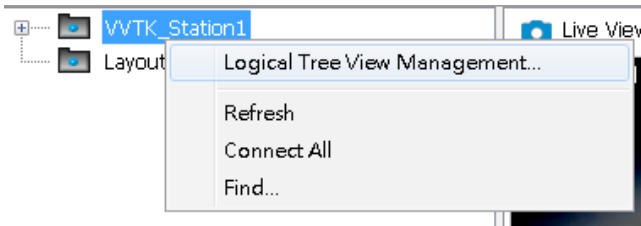

You will then enter the **Logical Tree View** management window. Left click on the root directory, and then right-click to display the **Add** command.

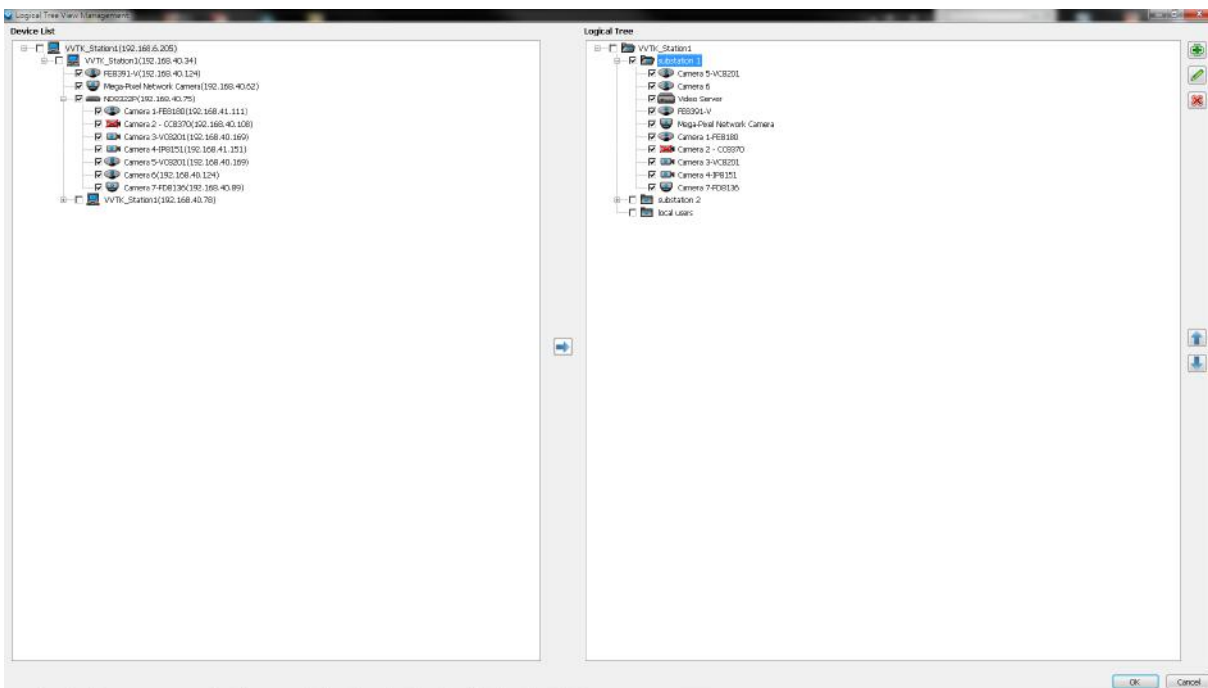

A Logical tree can also display and include the cameras from VAST substations. To enable connection with substations, make sure the **Relay Settings** is enabled both on the VAST Root and substations.

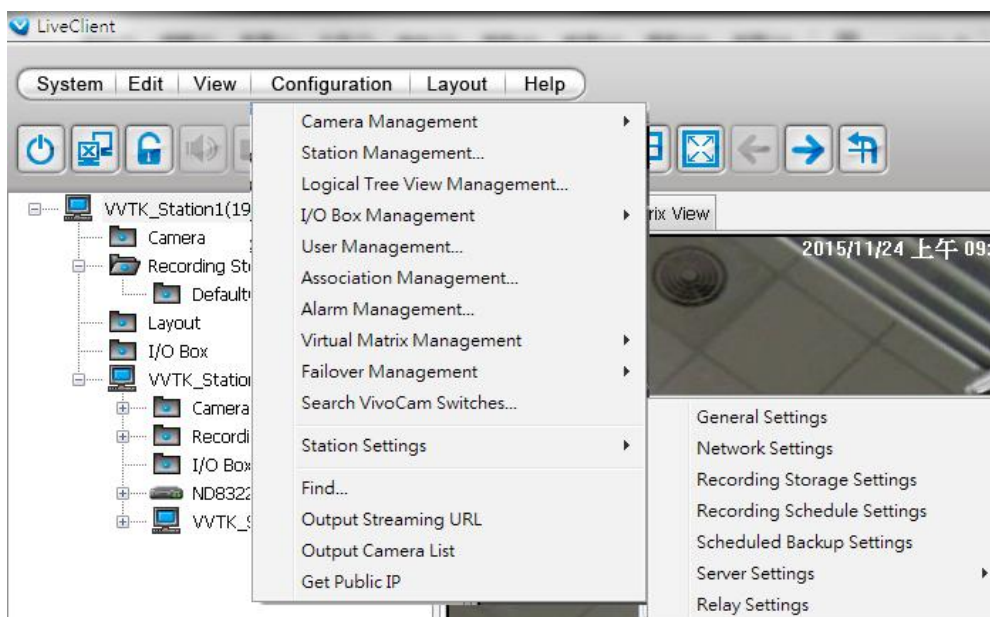



To create a logical folder, enter a name for the sub-directory. The name can be a geographical indicator or whatever name your prefer; such as Building A, Site 1, etc. Add a short description.

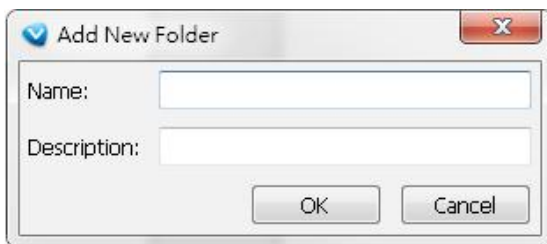

You can also create logical folders under sub-directories, e.g., a "Corridor" under "Building A." Do this by selecting a sub-directory with a left-click and then right-click on it.

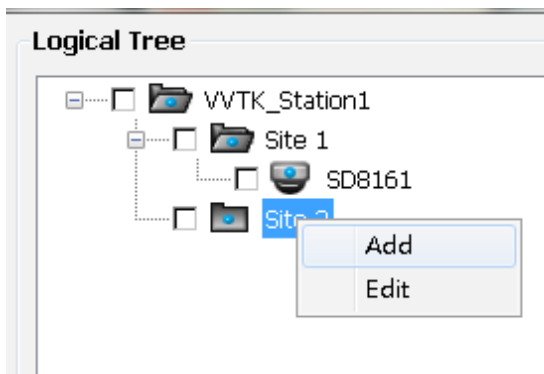

Note that the root directory can not be edit.

You may also left-click to select a sub-directory, and use the **Add**, **Edit**, and **Delete** buttons to create, edit, or remove sub-directories. Use the arrow buttons to change the positions of sub-directories or devices on the logical tree.



When done, click the **OK** button at the low right corner of the window. Configuration changes will be preserved.

You should then insert cameras to a preferred directory:

1. Open the device tree to select camera. Left-click to select the checkboxes in front of cameras.
  2. Select the checkbox of a preferred sub-directory. Make sure the checkbox is selected and the directory is highlighted.
  3. Click the **Move** button in the middle of the screen.
- Cameras will be listed under the target sub-directories.

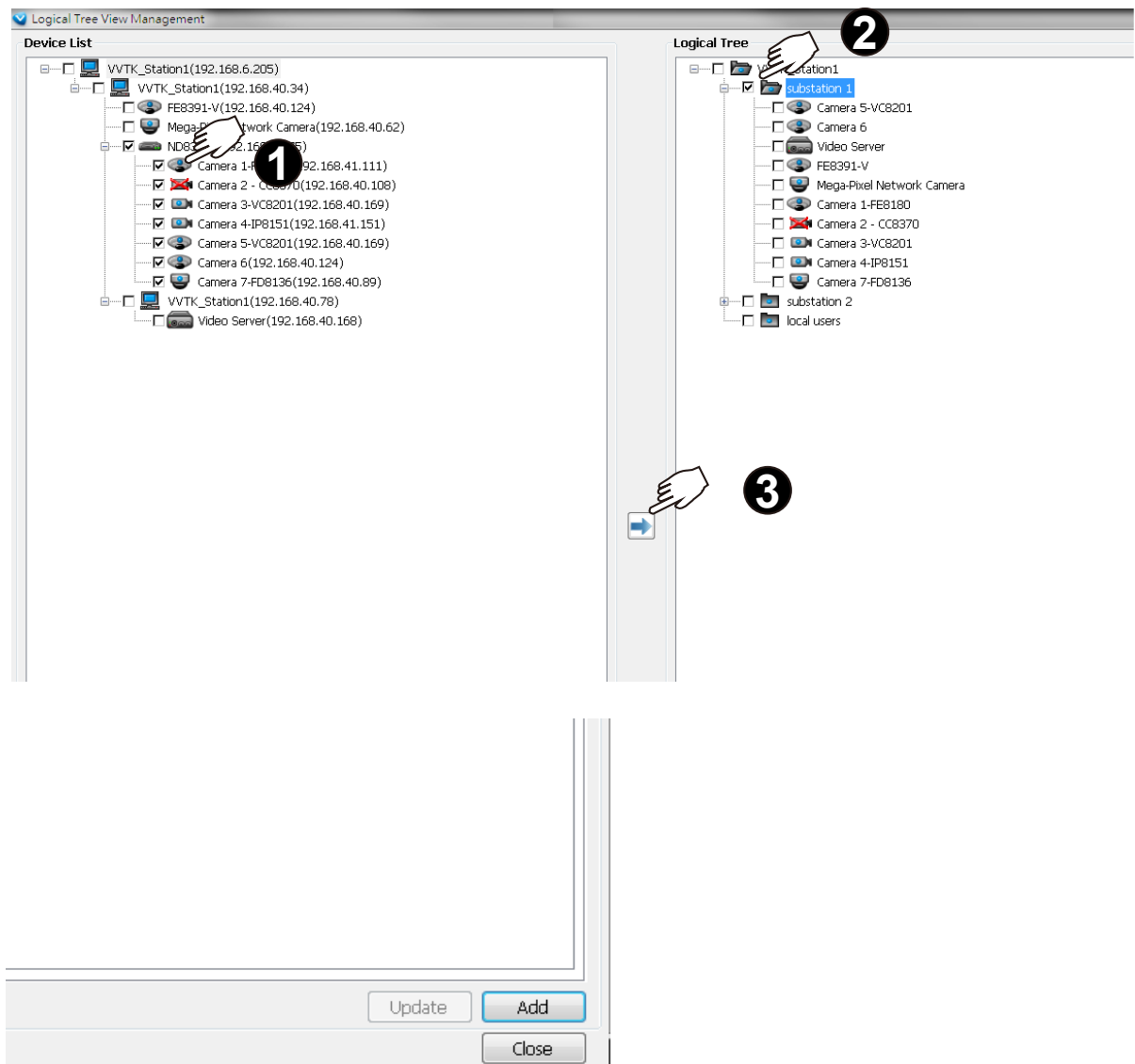

Use the Sort and Find functions on the Device List on the left panel if it is hard to locate a device.

When done with the configuration, click the OK button, and select from the top menus **View** > **Logical Tree View**. The Logical Tree View will become the standard display for your VAST configuration.

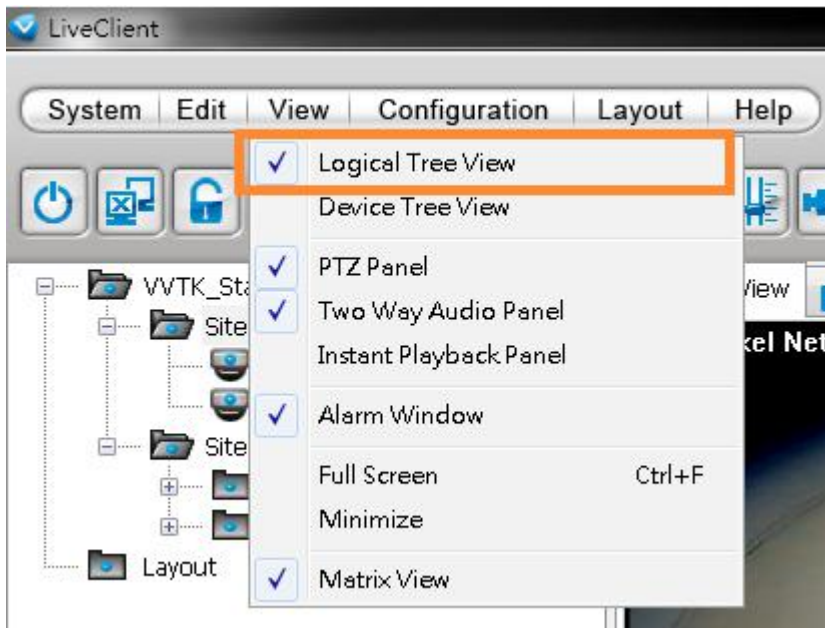

When done with the creation of logical folders, you can move to the **User Management** window. You can then define users' access rights using the logical folders you created. For example, you may let a user access a specific logical folder while forbidding him from the others.

1. When you assign Accessible Devices for a user, select the **Logical tree** button on the lower right.
2. Select the **"Selected logical tree nodes"** button. You can then select or deselect logical folders to confine the accessible devices for a user.

Note that an administrator has access to all devices, and hence the selection is not available for an administrator.

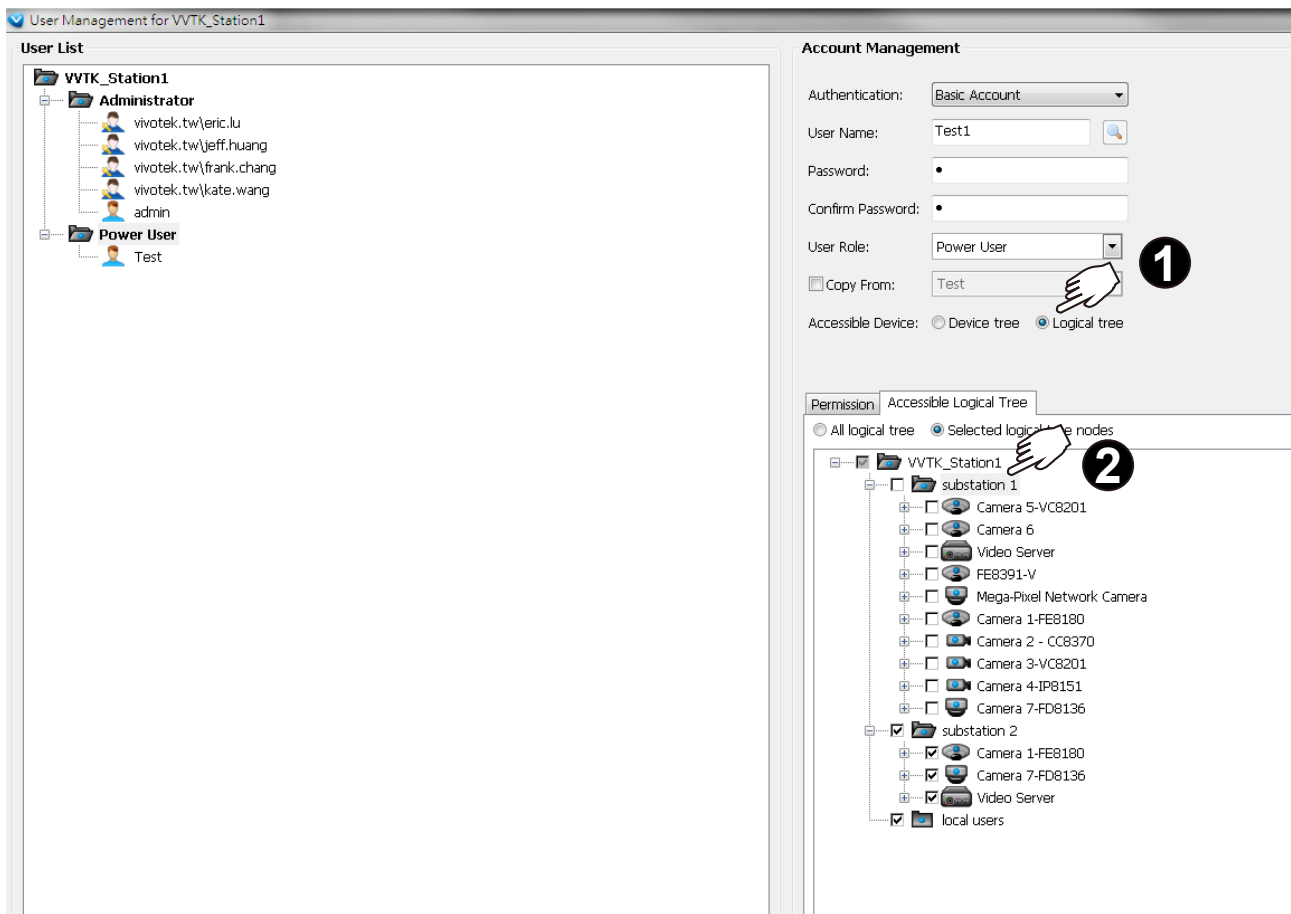

3. Click the **Add** button on the lower right.

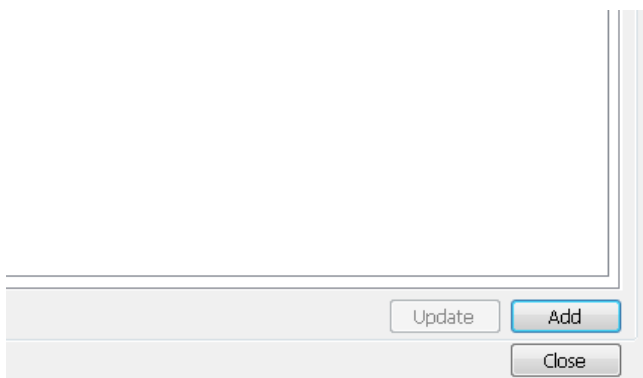

4. The User account information will prompt. Click **OK** to proceed.



5. You can repeat the above steps to create more user accounts using the limited access configuration via the use of logical folders.



- The Refresh, Camera Settings, Output Streaming URL, Send to Talk Panel commands are available for cameras listed in the Logical Tree View.
- The DI/DO, Recording Storage, and I/O Box are not available on a Logical Tree View.
- The root directory (default VVTK\_Station1) can not edited or removed.
- A camera can be added to different sub-directories; however, it can not be added twice into the same sub-directory.
- A camera managed by a sub-station can be added into the Logical Tree.
- The Logical Tree View can not be edited through a web console with the VAST server.
- Cameras added to the VAST configuration will not be automatically added to the Logical Tree View.
- By default, only the administrator and power user are authorized to configure the Logical Tree View.

# VAST Playback Configuration

## Activating VAST Playback and Logging in to a Server

VAST Playback allows you to search and playback recorded media data from VAST Server.

Once you insert a device into the hierarchical management tree of VAST LiveClient, it will automatically be displayed on the hierarchical management tree of VAST Playback. You can then begin to use VAST Playback to view recorded or backup video clips.

After installing the VAST Playback program, please follow the steps below to activate VAST Playback:

1. Run the **VAST Playback** program. If you have already run VAST LiveClient, you can also click **System > Launch Playback** to activate VAST Playback.
2. A **Login** window will pop up. Fill in the information as shown below:
  - If you want to login to a remote VAST Server, enter the **IP address**, **user name**, **password** and **communication port** of the server. Click **Log in** to login the target server or **Cancel** to exit the system.
  - If you want to login to your local host which is running VAST Server, check the **Login local station** checkbox, and the local **IP Address** will be displayed automatically. Enter the **User Name**, **Password**, and **Communication Port** of the local server to log in. Click **Login** to log in to the target server or **Cancel** to exit the system.

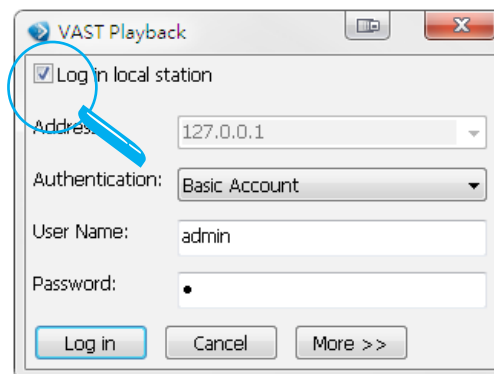
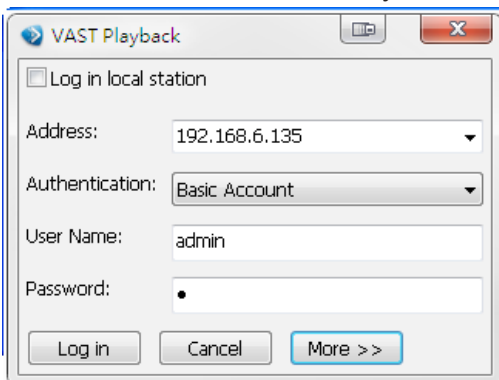

3. The VAST Playback main window will be displayed.



- If your network environment need to set up proxy, click **More >>** to extend the login window, then click **Proxy Setting** to open the dialog. Then enter related information to link to your proxy server.

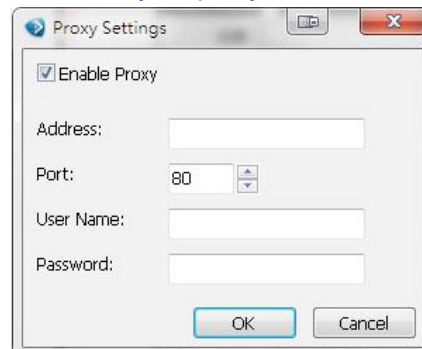
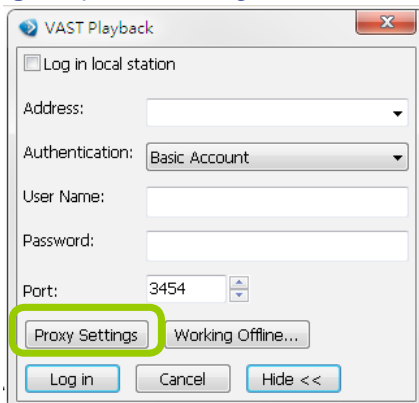

- Available functions of the VAST Playback program will be enabled according to the role of your login account. For more details about the privileges of the user account, please refer to **How to Manage User Accounts** on page 100.



## VAST Playback User Interface

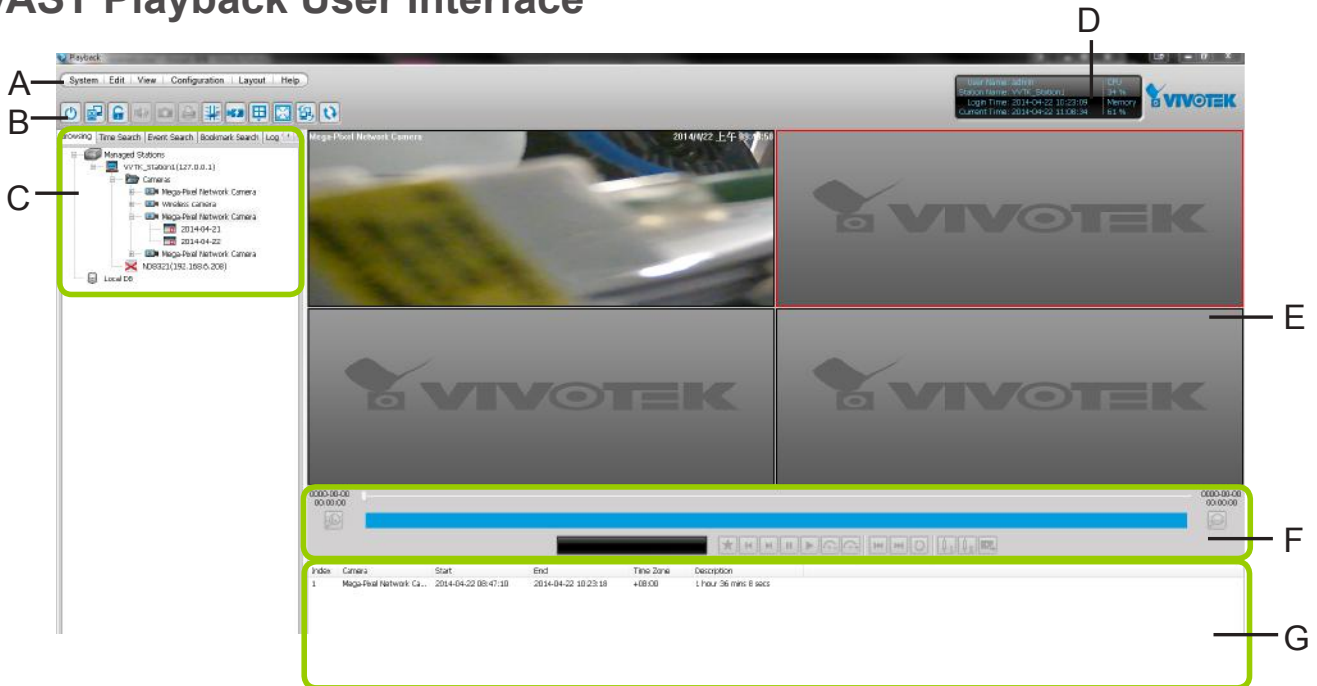

- A. Menu bar
- B. Quick access bar
- C. Query panel (Browsing / Time search / Bookmark search / Event search / Alarm search / Log viewer)
- D. Status panel
- E. Recorded video playback window
- F. Playback control panel
- G. Video clips list

### Menu Bar

Menu Item	Drop-down Options
System	Lock / Language / Launch LiveClient / Logout / Exit
Edit	Snapshot / Print / Snapshot zoomed image / Print zoomed image / Find
View	Logical Tree View / Device Tree View / Backup Status /Exporting Status / Browsing / Time Search / Event Search / Bookmark search / Alarm search / Log Viewer / Full Screen / Minimize / Query Panel / Video Clips List
Configuration	Client Settings (Snapshot Settings / Export Settings / View Settings / Proxy Settings / General Settings / PiP Settings)
Layout	Change Layout
Help	About

### Status Panel

User Name: admin	CPU
Station Name: VVTK_Station1	35 %
Login Time: 2014-04-22 10:23:09	Memory
Current Time: 2014-04-22 11:14:54	61 %

User Name
Station Name (IP Address)
Login Time (yyyy-mm-dd hh:mm:ss)
Current Time (yyyy-mm-dd hh:mm:ss)
CPU and memory usage in percentage

## Quick Access Bar



Icon	Function	Description
	Exit	Exit the system
	Logout	Logout from the current station
	Lock	Click to Lock the system for security concerns (  Unlock the system)
	Volume	Adjust the audio volume of the target video (  Mute)
	Snapshot	Capture the picture of the target video
	Print	Print out the picture of the target video
	SVC Level	Exert SVC control of video playback frame rate
	Remove All Connection	Remove all live videos from the live video monitoring window
	Layout	Change the layout of video monitoring window
	Full Screen	Maximize the live video monitoring window
	Switch Screen	Switch to another screen
	Synchronous Playback	Click to enable synchronous playback for multiple channels



Some buttons will be disabled if the selected device does not support those functions.

## Recorded Video Playback Window

The "VIVOTEK" logo indicates that no camera has been assigned to the video cell.

The red frame ( ) represents the focused cell.



## Language Selection

VAST current supports user interfaces in multiple languages; and language options are available in: English, Deutsch, Español, العربية, Français, Italiano, 日本語, Português, Русский, 简体中文, and 繁體中文, User Defined. If you want to select another language for the interface, please click **System > Language** on the menu bar to select a desired language. Please note that if you want to change the language option, a message will remind you to restart the system.

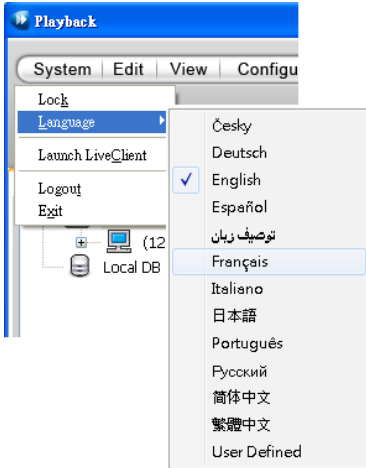

*If you want to use "User Defined" language, please prepare images and language strings, and upload the files to the following folders:*

- ...IVASTClient\Playback\language\zz\_UD (language string)*
- ...IVASTClient\Playback\image (images)*







## Query Panel-- Browsing Page

**Managed Stations**

- VVTK\_Station1(127.0.0.1)
  - Cameras
    - 1\_PZ7131
      - 2009-11-24
      - 2009-11-25
    - 2\_IP8161
      - 2009-11-24
      - 2009-11-25
    - 3\_FD8161
      - 2009-11-24
      - 2009-11-25
  - Paul-Kuo(172.16.4.38)
    - Cameras
      - 1\_IP7138
        - 2009-11-22
        - 2009-11-23
      - 2\_IP7121
        - 2009-11-22
        - 2009-11-23
      - 3\_PZ7151
        - 2009-11-23
  - Owen(172.16.4.23)

Local DB

You can hide this panel in order to maximize the single playback view from the **View** menu.

Icon	Description
	Station list including server and local database
	A station (a computer that has installed VAST Server)
	A station (a computer that has installed ST7501 Server)
	The camera that exists on the hierarchical management tree of LiveClient.
	The camera that has been removed from the hierarchical management tree of LiveClient (off-line). However, its recorded video (if any) is still accessible from the server.
	Dates with recorded video clips.
	Local database for backup data. For more information about how to upload backup data to the list, please refer to page 250.



---

See [page 217](#) for how to configure a Logical Tree View.

## Query Panel--Time Search Page

The screenshot shows the 'Time Search' tab in a software interface. At the top, there are tabs for 'Browsing', 'Time Search', 'Event Search', 'Bookmark Search', and 'Log'. The main area is a tree view showing a hierarchy of stations and devices. The 'VWTK\_Station1(127.0.0.1)' is selected and expanded, showing a 'Cameras' folder which is also expanded to show three cameras: '1\_PZ7131', '2\_IP8161', and '3\_FD8161', all of which are checked. Below the tree view, there is a 'Time Zone' dropdown menu set to 'GMT+08:00 Beijing, Chongqing, Hong k'. Below that, there are checkboxes for 'Start Time' (checked) and 'End Time' (unchecked). The 'Start Time' is set to '2009/11/23' at '08:50:15'. The 'End Time' is set to '2009/11/26' at '09:50:15'. A 'Search' button is located at the bottom right of the panel.

Select station(s)/ device(s) that you want to search for recorded files

Specify search period of time

Click to start to search, the results will be shown on the video clips list

You can hide this panel in order to maximize the single playback view from the **View** menu.



The **Time Zone** setting is automatically synchronized with that on your client computer.

## Query Panel--Event Search Page

The screenshot shows the 'Event Search' tab in a software interface. At the top, there are four tabs: 'Browsing', 'Time Search', 'Event Search' (highlighted with a green box), and 'Bookmark Search'. Below the tabs is a tree view showing a hierarchy: 'VWTK\_Station1(127.0.0.1)' (checked), 'Cameras' (checked), and four 'Mega-Pixel Network Camera' items (all checked). A blue box highlights the bottom-most camera item. Below the tree view is a 'Search Categories' dropdown menu set to 'All Events'. A list of search criteria is shown below, with 'Motion - Window 1' selected. Below the list are 'Add' and 'Remove' buttons. Further down is a 'Time Zone' dropdown set to 'GMT+08:00 Beijing, Chongqing, Hong Kong'. There are checkboxes for 'Start Time' and 'End Time', each with date and time pickers. At the bottom left is a checkbox for 'Display in New Result List' and a 'Search' button at the bottom right. Blue lines with text annotations point to various elements: 'Select station(s)/ device(s) that you want to search for recorded files' points to the tree view; 'Select an Event Category' points to the 'Search Categories' dropdown; 'Click to add search criteria' points to the 'Motion - Window 1' list item; 'Click to remove search criteria' points to the 'Remove' button; 'Specify search period of time' points to the 'Start Time' and 'End Time' sections; and 'Click to start to search, the results will be shown on the video clips list' points to the 'Search' button.

Select station(s)/ device(s) that you want to search for recorded files

Select an Event Category

Click to add search criteria

Click to remove search criteria

Specify search period of time

Click to start to search, the results will be shown on the video clips list

## Query Panel--Bookmark Search Page

The screenshot shows a software interface for searching bookmarks. At the top, there are five tabs: 'Browsing', 'Time Search', 'Event Search', 'Bookmark Search' (which is highlighted with a green box), and 'Alarm Search'. Below the tabs is a tree view showing a folder 'VTK\_Station1(127.0.0.1)' containing a sub-folder 'Cameras' with five 'Mega-Pixel Network Camera' entries, each with a checkbox. Below the tree view is a 'Bookmark Name:' text input field. Underneath is a 'Time Zone:' dropdown menu showing 'GMT+08:00 Beijing, Chongqing, Hong Kong, Kuala Lumpur'. There are two time selection sections: 'Start Time:' with a checked checkbox, and 'End Time:' with an unchecked checkbox. Each time section includes a date dropdown (showing '8/ 1/2012') and a time spinner (showing '14:52:56' for start and '15:52:56' for end). A 'Search' button is located at the bottom right. Five blue callout lines point to these elements with the following text:

- Select station(s) that you want to search for bookmarks
- Select a name to search for
- Select a time zone
- Specify search period of time
- Click to start to search, the results will be listed on the video clips list

## Query Panel--Alarm Search Page

The screenshot shows the 'Alarm Search' page in a software application. The interface includes a menu bar (System, Edit, View, Configuration, Layout, Help), a toolbar with various icons, and a main search area. The search area is divided into two panes: a left pane for selecting stations and a right pane for displaying search results. Below the search area are controls for filtering, time zone selection, and search parameters (start and end times). A 'Search' button and an 'Export All Logs' button are located at the bottom of the search area.

**Annotations:**

- Select station(s) that you want to search for bookmarks:** A green box highlights the station 'VMS\_Station(127.0.0.1)' in the left pane.
- Click to configure the search conditions:** A blue line points to the 'Filter' button.
- Select a time zone:** A blue line points to the 'Time Zone' dropdown menu.
- Specify search period of time:** A blue line points to the 'Start Time' and 'End Time' input fields.
- Click to export a log files for the occurrences of alarms:** A blue line points to the 'Export All Logs' button.
- Click to start to search, the results will be listed on the video clips list:** A blue line points to the 'Search' button.

Index	Name	Description
1	Alarm	
2	Alarm	
3	Alarm	
4	Alarm	



## Query Panel--Log Viewer Page

The screenshot shows the 'Log Viewer' tab selected in a navigation bar. Below the navigation bar is a tree view of stations, with 'VVTK\_Station1(127.0.0.1)' selected. Underneath it are two sub-stations: 'Paul-Kuo(172.16.4.38)' and 'Owen(172.16.4.23)'. Below the tree view are several filter fields: 'Category' (All Local Logs), 'User' (empty), 'Result' (All), 'Log Type' (All), and 'Log Level' (All). There is a checkbox for 'Including above level' which is checked. Below these is a 'Time Zone' dropdown set to 'GMT+08:00 Beijing, Chongqing, Hong k'. There are two time selection sections: 'Start Time' (checked) with date '2009/11/26' and time '08:50:16', and 'End Time' (unchecked) with date '2009/11/26' and time '09:50:16'. A 'Search' button is at the bottom right.

Bookmark Search Alarm Search **Log Viewer**

VVTK\_Station1(127.0.0.1)  
Paul-Kuo(172.16.4.38)  
Owen(172.16.4.23)

Category: All Local Logs  
User:  
Result: All  
Log Type: All  
Log Level: All

Including above level

Time Zone: GMT+08:00 Beijing, Chongqing, Hong k

Start Time:  
2009/11/26 08:50:16  
 End Time:  
2009/11/26 09:50:16

Search

Select station(s) that you want to search for recorded logs

Select a Log Category

Select a User Account

Select a Result Type

Select a Log Type

Select a Log Level

Specify search period of time

Click to start to search, the results will be listed on the video clips list

## Video Clips List Window

If you select an option “date”, the video clips will be displayed in the video clips list window. An option “date” may contain more than one video clip.

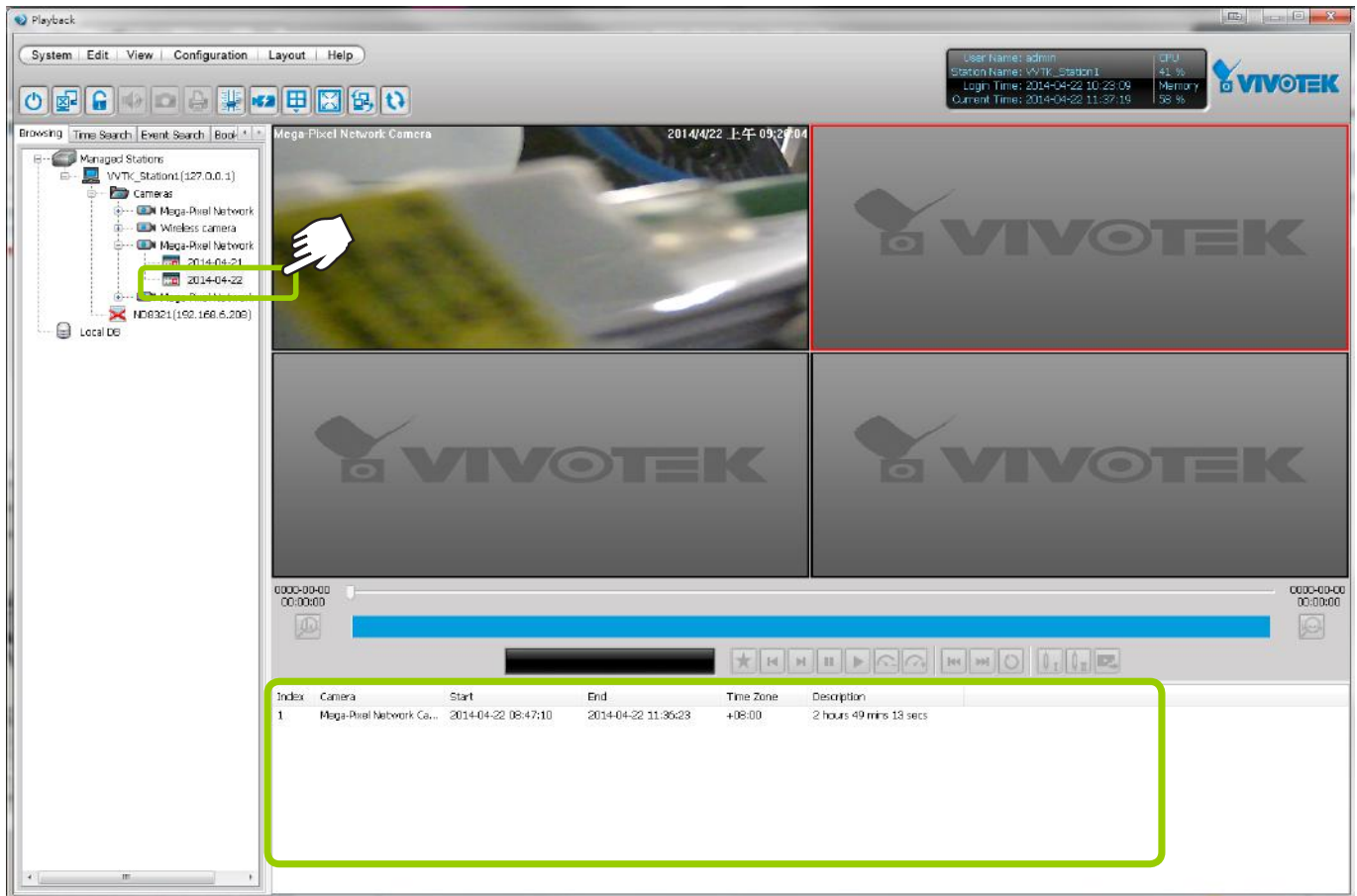

You can hide this panel in order to maximize the single playback view from the **View** menu.

## Playback Control Panel

When you double-click a video clip to play, the playback control panel will be enabled for you to use.

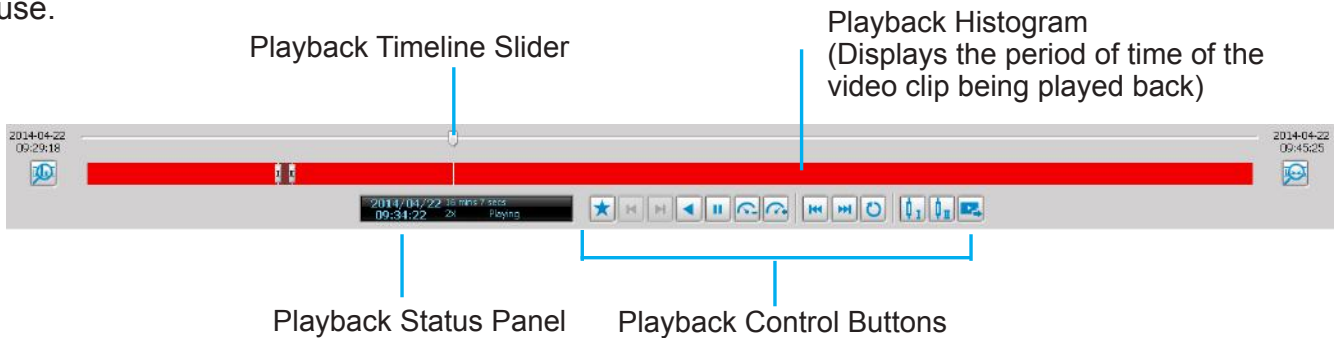

Icon	Function	Description
	Add Bookmark	Manually add a bookmark to pinpoint and extract a 20-second video clip from an existing recording
	Histogram Zoom In	Zoom in on the displayed period of time of the histogram
	Histogram Zoom Out	Zoom out of the displayed period of time of the histogram
	Marker I	If you want to export part of the recorded video clip, click to set marker I on the histogram, which will be the start time of the exported media
	Marker II	If you want to export part of the recorded video clip, click to set marker II on the histogram, which will be the end time of the exported media
	Export Media	Click to export the selected section of video clip
	Last Time Interval	Go to the previous video clip on the video clips list
	Pause	Pause playback the selected video clip
	Play	Start to playback the selected video clip
	Rewind	Reversely plays back the current video
	Next Frame	Go to the next video frame of the selected video clip
	Previous Frame	Displays the previous frame
	Next Time Interval	Go to the next video clip on the video clips list
	Repeat Mode	Playback the selected video clip repeatedly
	Slow Down	Slow down the playback rate
	Speed Up	Speed up the playback rate

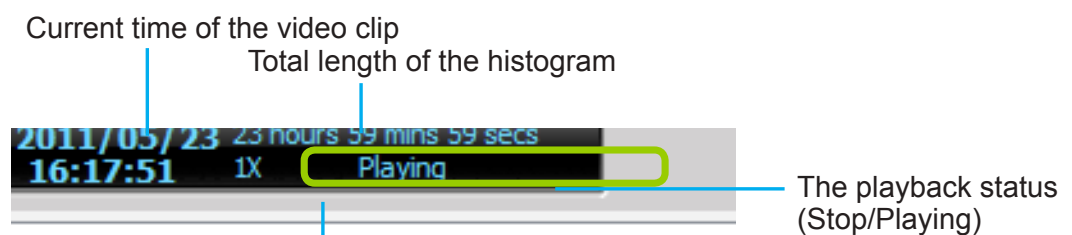

The playing rate can be 1/8, 1/4, 1/2, 1X, 2X, 4X, 8X, 16X, 32X, and 64X.

## Rewind

The Rewind function enables users to reversely playback from a specific point in time on a video playback window. Once the occurrence of an event is ensured, this function can facilitate the process of finding the evidences that appeared before the occurrence.

The Rewind function also applies to the Synchronous Playback mode. The following also apply:

1. The maximum playback speed is 64x. (I-frame only when speed is higher than 16x)
2. When you pull the time slider during the Rewind playback, short interruptions may occur.
3. When switching from the playback mode to the Rewind playback, the playback speed remains the same. The same applies when switching from Rewind to the playback mode.

### Limitations:

1. Short delays may occur when switching from playback to rewind, due to limitations by the hard disk access speed and network speed.
2. When doing the forward playback, the previous frame function is not available. When doing the rewind playback, the next frame function is not available.
3. The Rewind playback on multiple streams requires system performance resources.

# How to Playback Recorded Video

## Select a Recorded Video Clip

Please follow the steps below to select a video clip:

1. On the **Browsing** page, click the plus sign (+) to expand the hierarchical management tree.

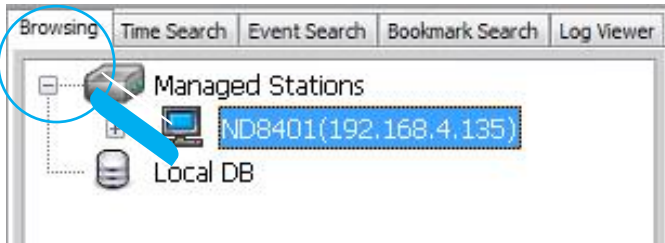

2. **Right-click** a station, device, or option "date" on the hierarchical management tree and click **Refresh** to display the recorded video clips.

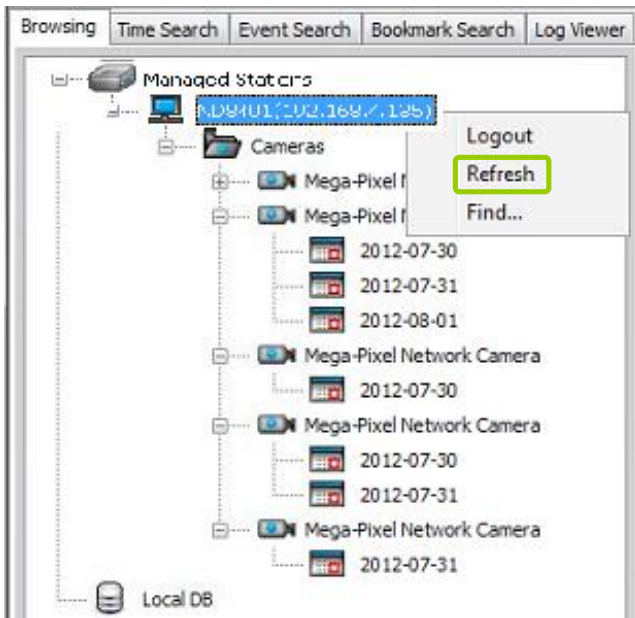

If a camera is configured with Multiple Stream recording, all its recording group configurations will be listed on the device tree.

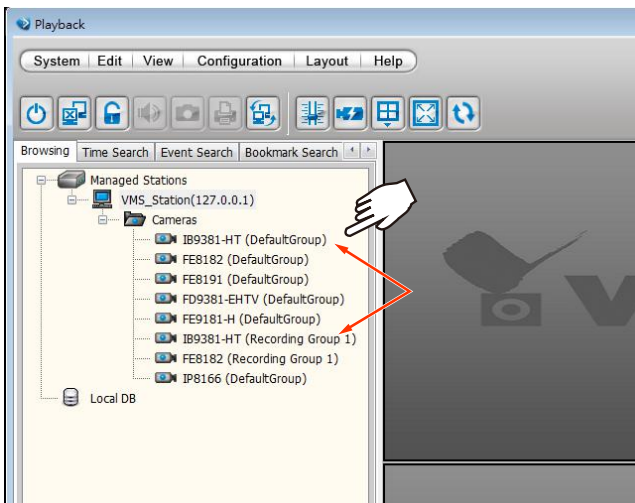

3. There are two ways to view the video clips of a date.

- View all video clips of a date:
  - a. Select an **option** “date” from the hierarchical management tree.
  - b. **Double-click** the option “date” or **right-click** the option “date” and click **play**, and it will start to play in an available video cell. (You can also directly **drag-and-drop** the option “date” to a desired video cell in the recorded video playback window. The video clip will start to play.)

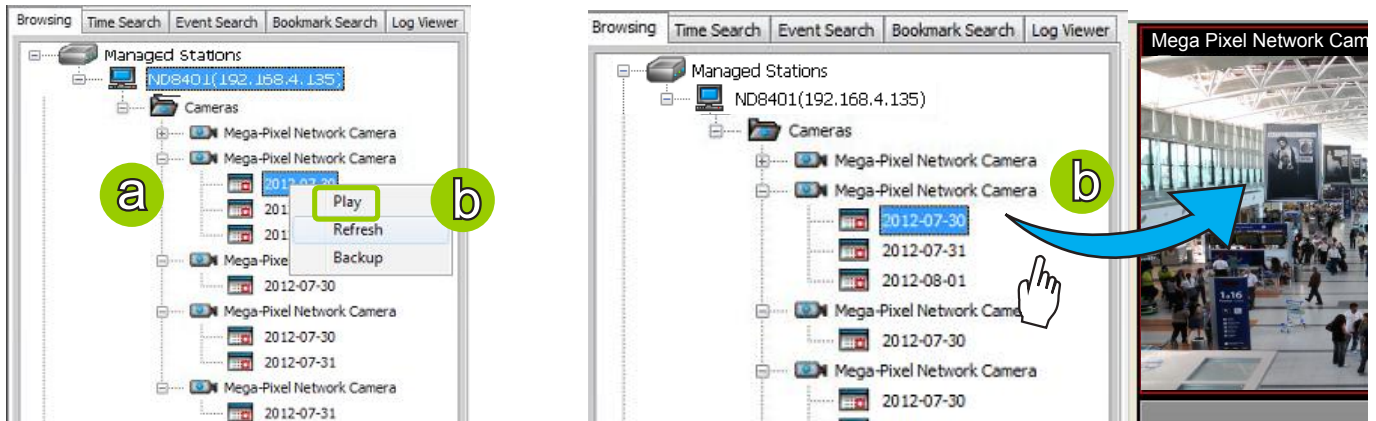

- View only one of the video clips of a date:
  - a. Click on a “date” on the hierarchical management tree. The corresponding video clips will be listed in the video clip list window.
  - b. Select a video clip from the video clip list window.
  - c. **Double-click** the video clip, then it will start to play in an available video cell. (You can also directly **drag-and-drop** the video clip to a desired video cell in the recorded video playback window. The video clip will start to play.)

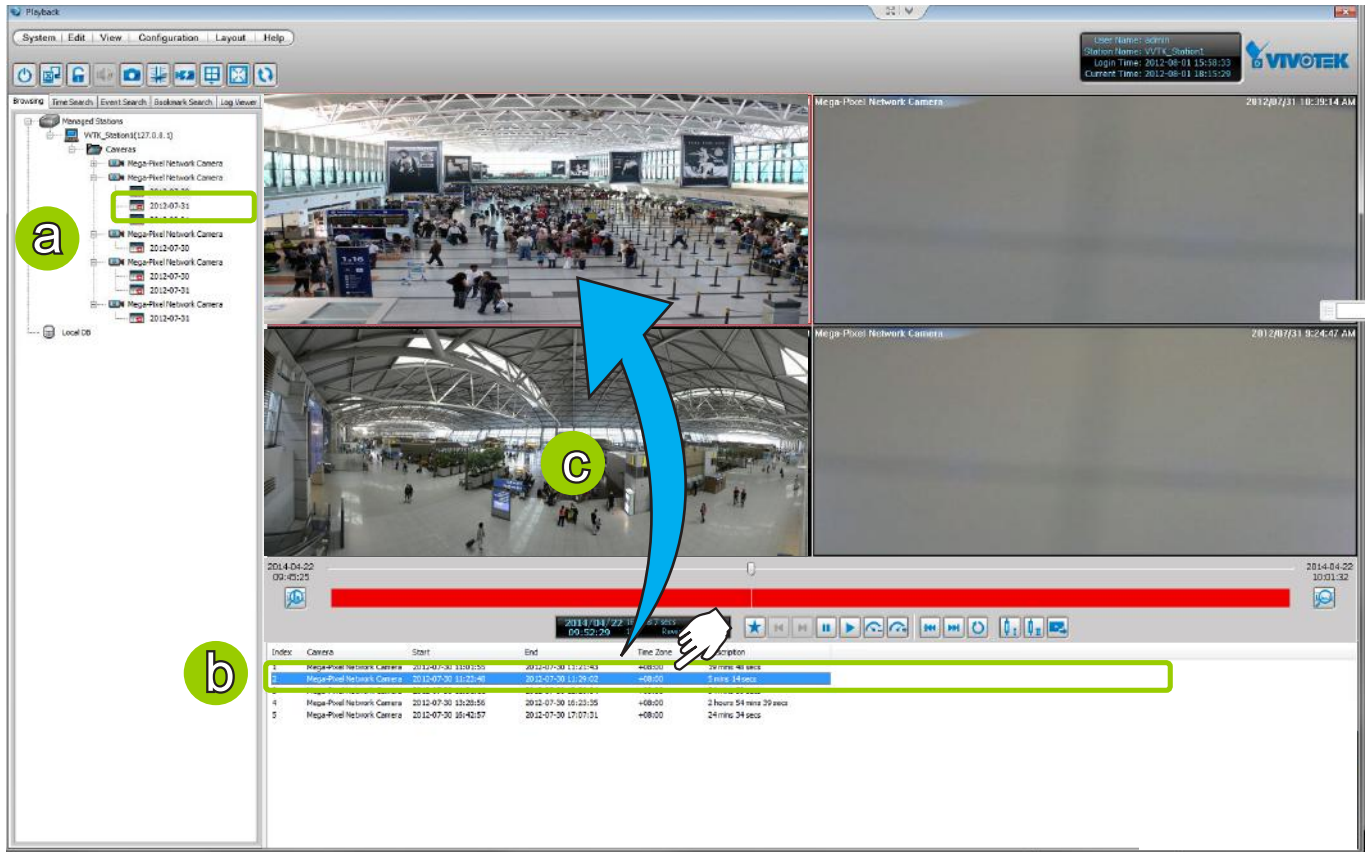

4. Then you can make use of the playback control panel to playback the selected video clip. Please refer to **Playback Control Panel** on page 235.

## Remove Recorded Video Clips from Video Cells

There are two ways to remove a recorded video clip from the video cell:

1. **Right-click** the video cell and select **Remove**.

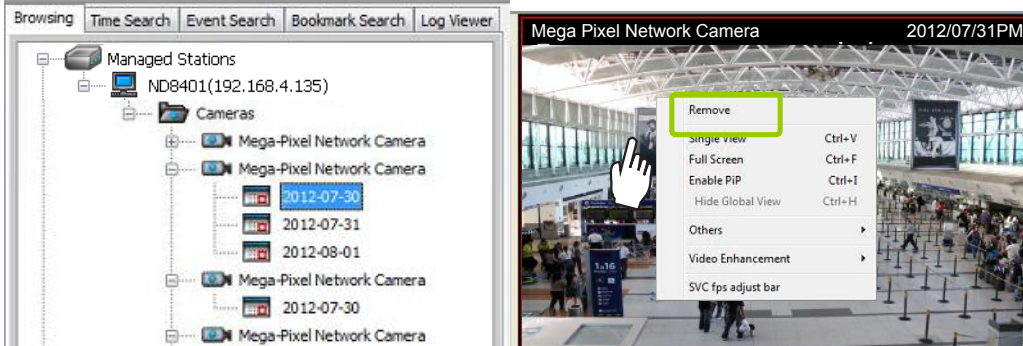

2. **Drag-and-drop** the live view from the video cell to the hierarchical management tree window.

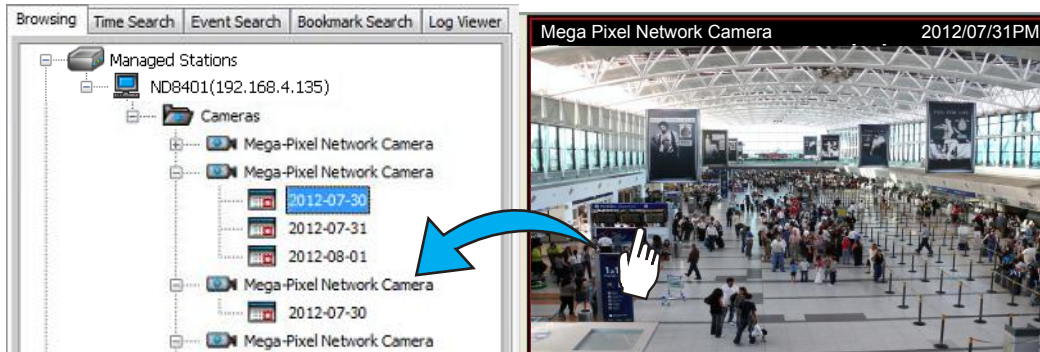

If you want to remove all live videos from the video cells, please click  on the menu bar.



## Timeline Slider Bar and Histogram

The red part of the histogram shows the period of time of a video clip. The timeline slider bar will move forward as the video is on playback. You can manually move forward/backward the **Timeline Slider Bar** to the desired position as shown below.

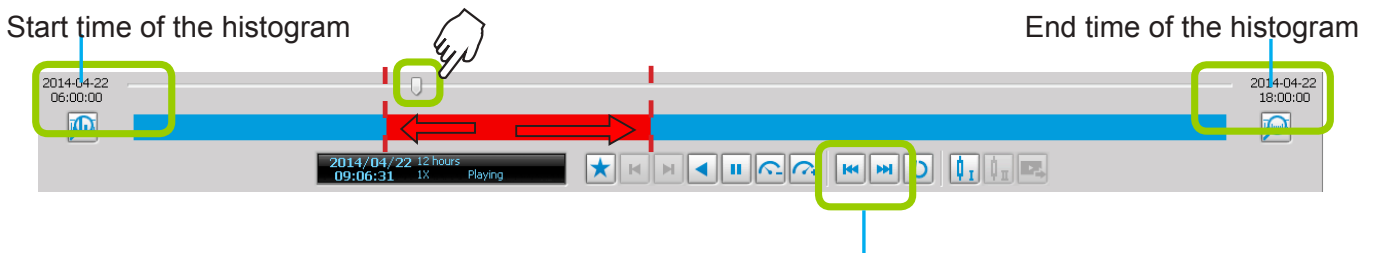

The current time of the video clip will be displayed on the status panel. It will change according to the current position of the timeline slider bar.



## Zoom in / out of the Histogram



Histogram zoom out



Histogram zoomed in

Total time length

As the second picture shows, by clicking **Histogram Zoom In**, the total time of the histogram will shorten to half of the original period of time, while the red part of the histogram that shows the period of time of the video clip will extend to twice the original time span.

In addition to clicking  and  to zoom in/ out of the histogram, you can use the mouse directly to drag the histogram to zoom in part of the focused video clip. For example:

a. Drag a section of the histogram. You can drag it to either direction.



b. The section will be extended as shown below.



For more functions of the playback control buttons, please refer to page 235 for detailed description.

## Synchronous Playback

VIVOTEK VAST Playback supports synchronous playback, which allows you to review up to 16-channel video clips simultaneously during the specific time point.

Please follow the steps below to enable synchronous playback:

a. Drag-and-drop the option “date”’s to the video cells.

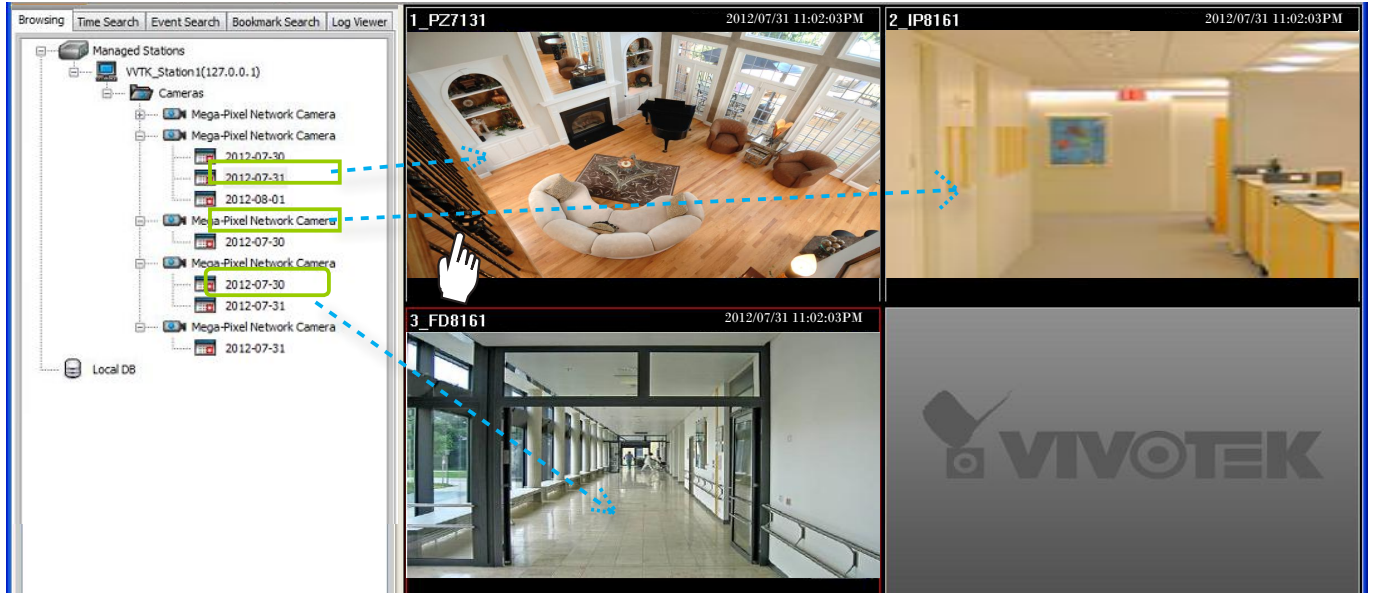

b. Drag the Timeline Slider Bar to the specific time point.

c. Click the synchronous playback button  on the quick access bar. The selected channel will start to synchronously playback as shown below.

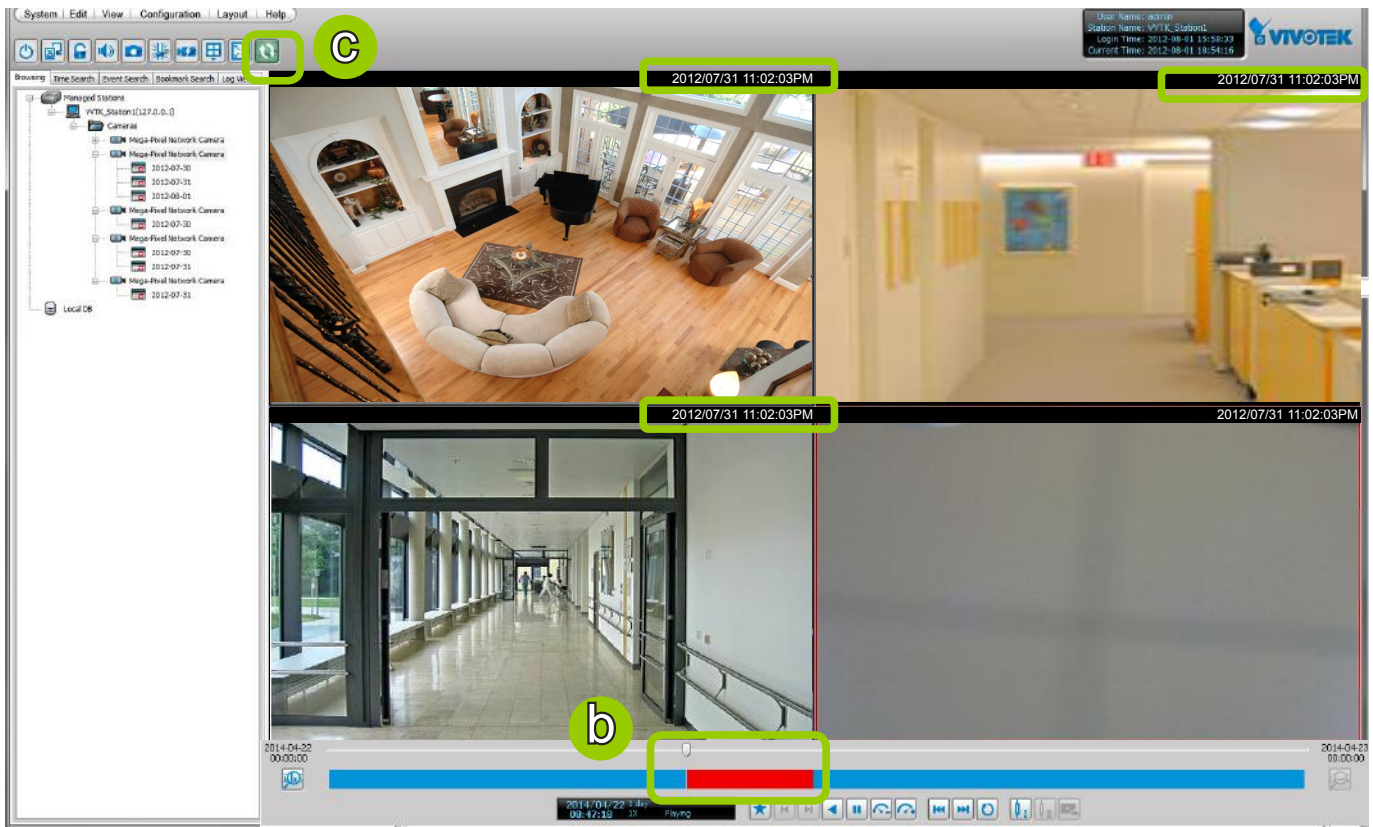

- d. You can move forward/backward the Timeline Slider Bar to another time point, and all of the time stamps on the video cells will change accordingly.
- e. If you want to stop synchronous playback, click the non-synchronous playback button  again.



The following illustration shows that during the specific time, there is no recorded video on the camera.

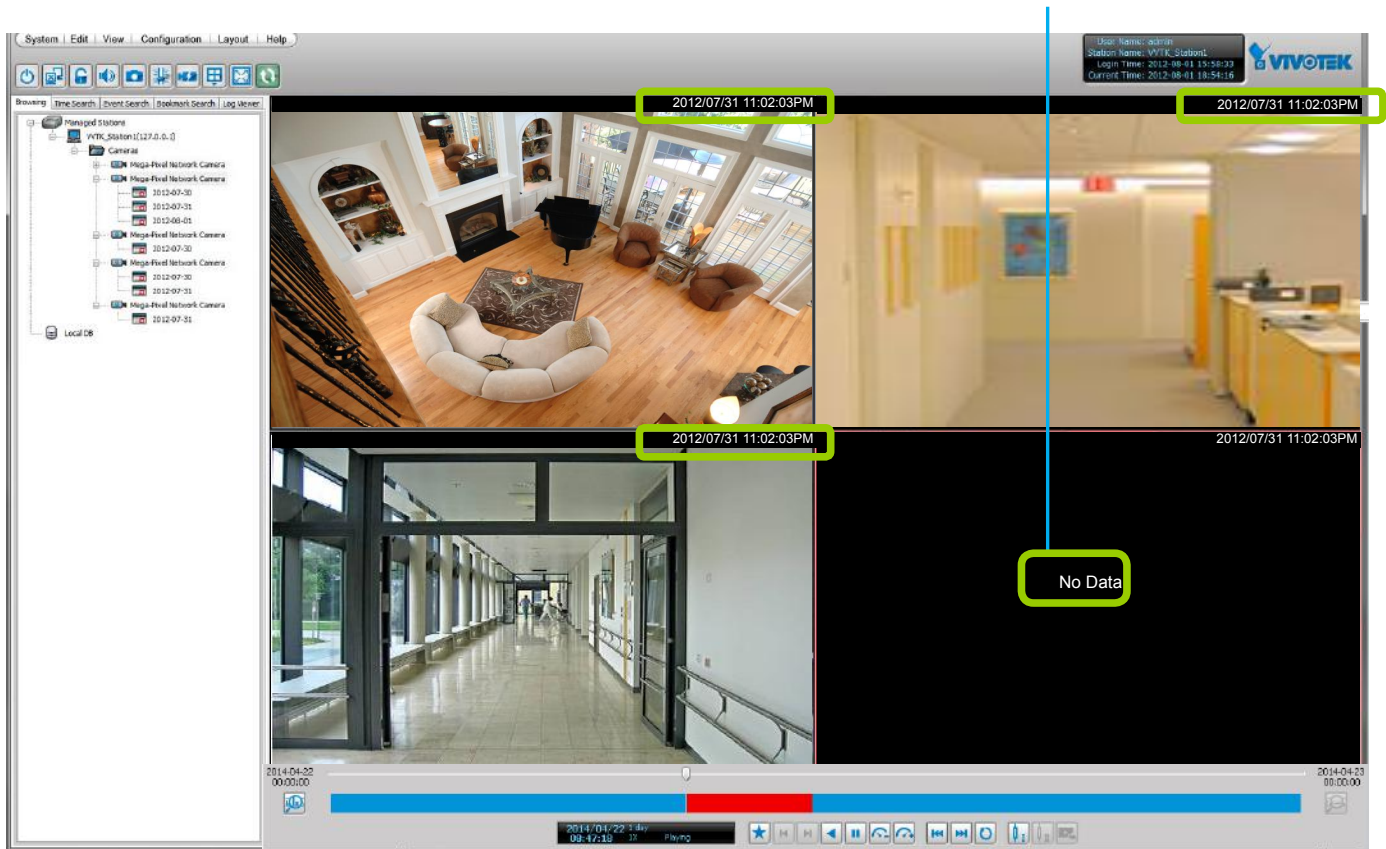



## Audio Control



The audio function will be enabled if the device is equipped with an internal or external microphone. Please follow the steps below to adjust the volume or turn on/off the audio of the focused video:

■ To turn off the audio (Mute Mode)

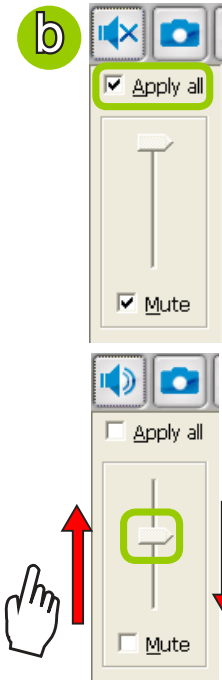
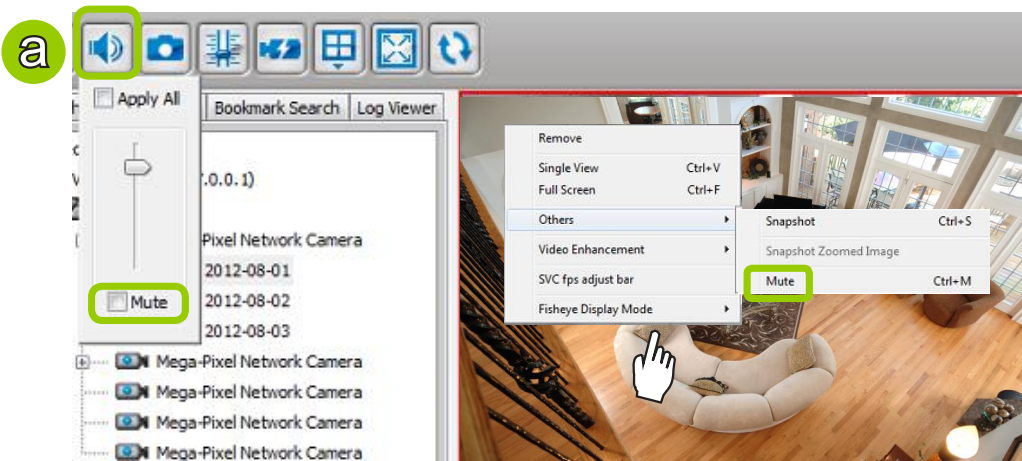

- a. Click **Audio On**  on the quick access bar and check **Mute**. Or you can **right-click** on the video cell to open the popup menu, then click **Others > Mute**. The mute option in the popup menu will then be selected.
- b. If you want to turn off the audio of all live video, select **Apply all**.
- c. The Audio icon will then change from  to .



■ To adjust the audio volume

- a. Click **Audio On**  on the quick access bar.
- b. Drag-and-drop the slider bar. Slide to a higher position for louder volume.

■ To turn on the audio

- a. Click **Mute**  on the quick access bar and uncheck **Mute**. Or you can **right-click** on the video cell to open the popup menu, then click **Others > Mute**. The mute option in the popup menu will then be unchecked.
- b. If you want to turn on the audio of all live video, select **Apply all**.
- c. The Audio icon will then change from  to .

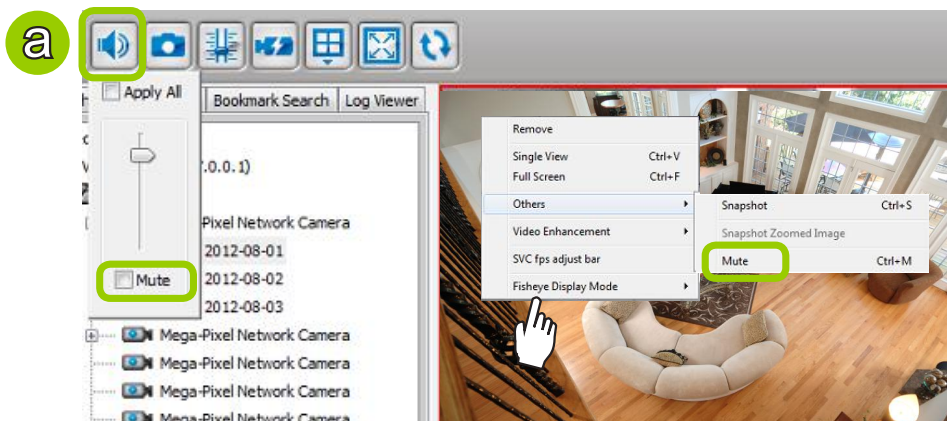

## How to Change the Playback Layout

### Changing the Layout of the Recorded Video Playback Window

VIVOTEK VAST Playback supports up to 16-CH simultaneous recorded video playback on a single monitor and allows you to change the layout of the recorded live video playback window based on the number of inserted devices.

#### Switch Video Channels

**Drag-and-drop** a video channel to another empty video window.





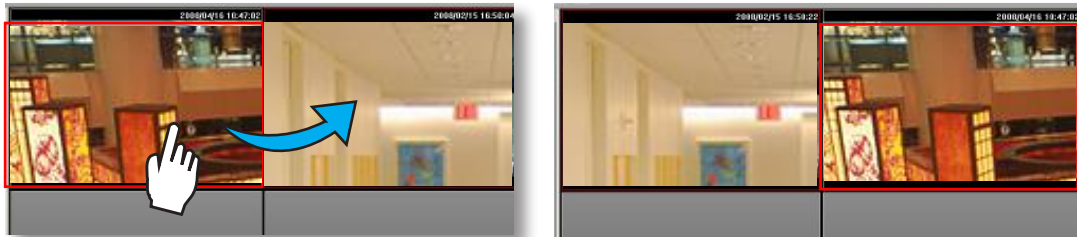





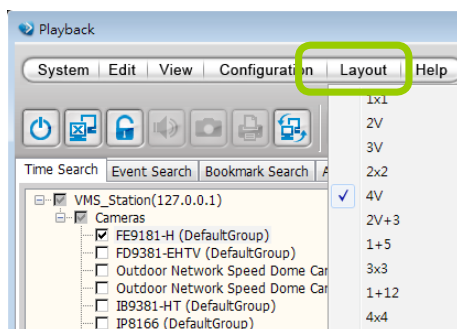

To switch two channels, **drag-and-drop** one view to the other, then the two channels will switch positions.



#### Configure Layout Mode

Click the **Layout** button  on the quick access bar or click **Layout > Change Layout** on the menu bar. Select a desired layout mode and the layout window will change accordingly. Below we illustrate 6 types of layout modes:



Layout mode	Description
1 x 1	
2V	
3V	
2 x 2	
4V	
2V+3	
1 + 5	
3 x 3	
1 + 12	
4 x 4	

## Maximize/Minimize the Recorded Video Playback Window

- Single View: to maximize a video cell to the entire video playback window

**Double-click** the video cell, or **right-click** the video cell and select **Single View**. The focused video will occupy the entire Playback window as shown below.

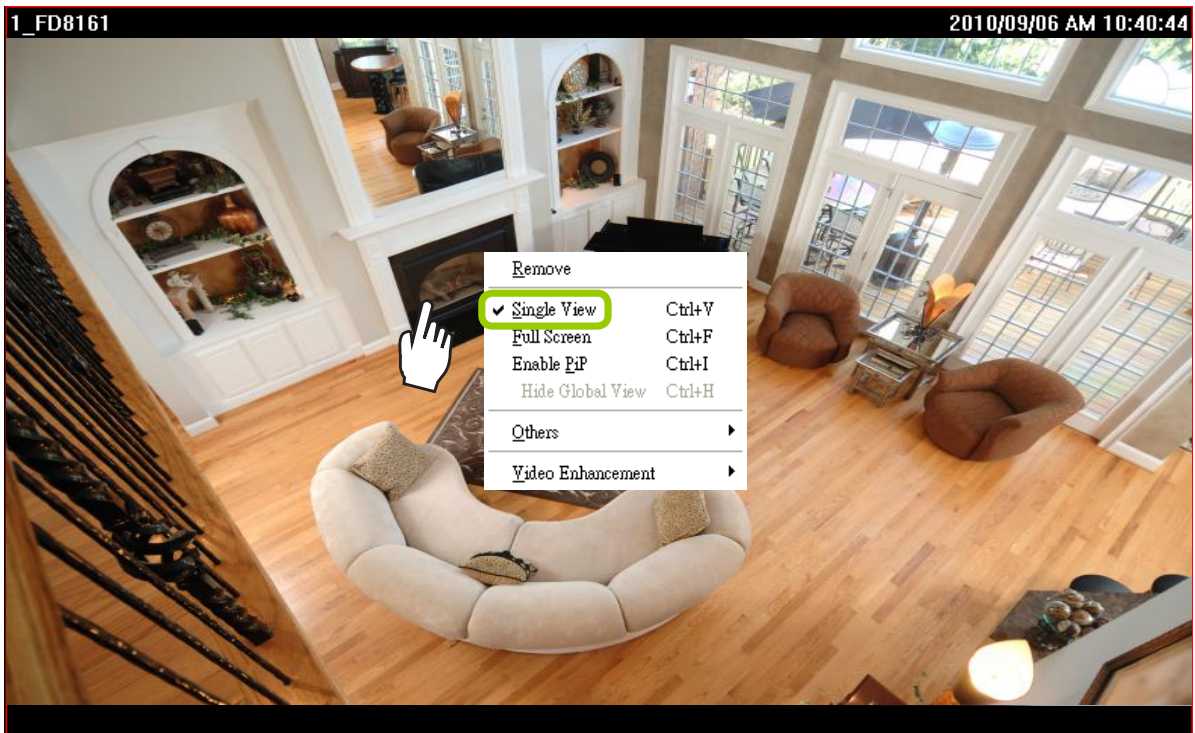
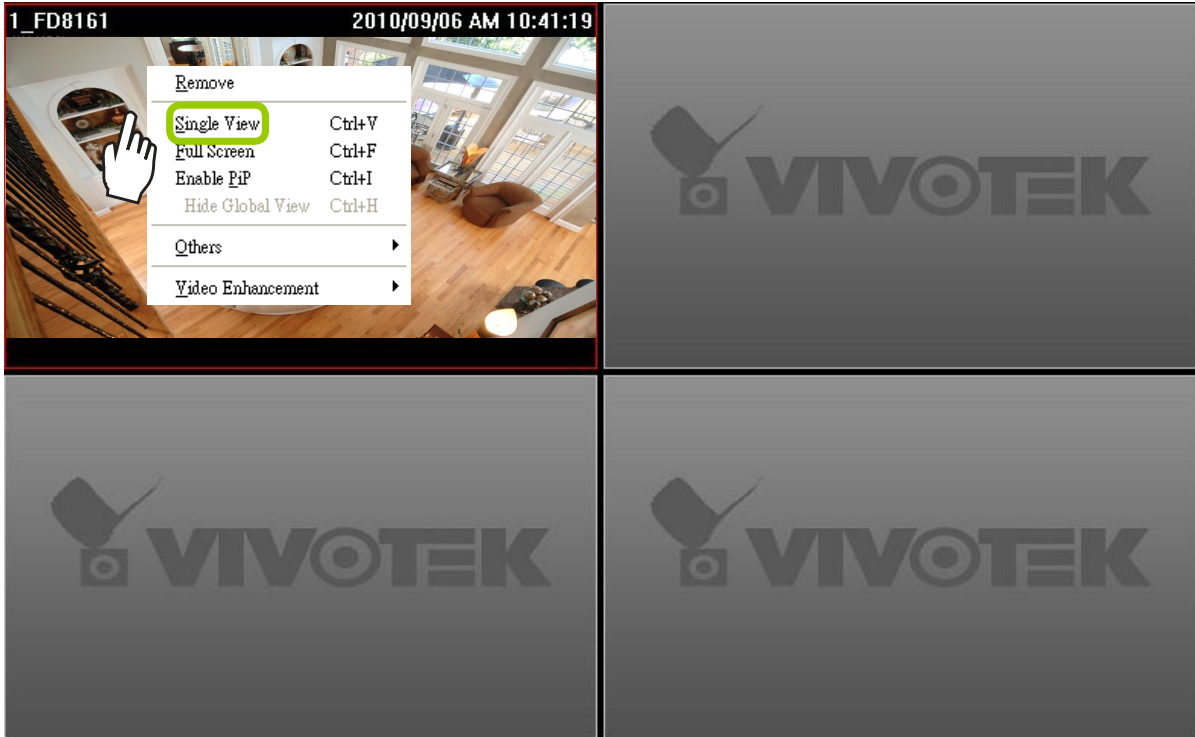

To restore to the original layout, **double-click** the video cell or **right-click** the video cell and uncheck **Single View**.

- Full Screen: to maximize the video playback window to the entire screen

Click **Full Screen**  on the quick access bar or **right-click** the video cell and select **Full Screen**. In addition, you can also click **View > Full Screen** on the menu bar to maximize the recorded video playback window.

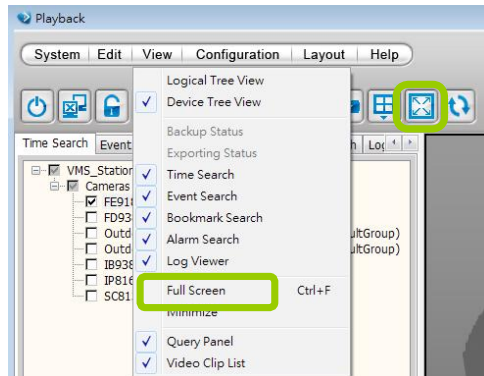

To restore to the original layout, **right-click** the video cell and uncheck **Full Screen**. You also can press the **Esc** button on the keyboard to leave the full screen mode.

- Minimize: If you click **View > Minimize** on the menu bar, the Playback window will minimize to the Windows tool bar.

## View Recorded Video with Multiple Monitors

If you have multiple screens in your control center, you can switch the VAST Playback Window among these screens.

- If you have two monitors, click **Switch Screen**  on the menu bar, the Playback window of monitor 1 will switch to monitor 2.

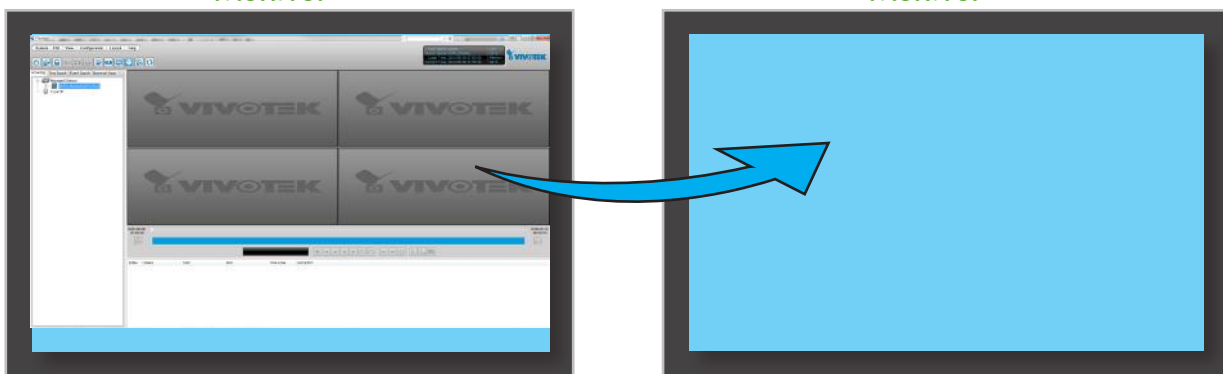

- If you have three or more monitors, a drop-down list will be displayed when you click **Switch Screen**  on the menu bar. The number of options on this list depends on the number of your screens. Select a desired screen from the drop-down list and the Playback Window will then switch to the specified screen.

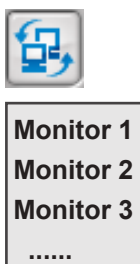

## How to Backup Recorded Video

In addition to the Schedule Backup function of VAST LiveClient introduced on page 61, the VAST Playback also features to backup recorded video clips from the **local database**. Please open the **Browsing** page and follow the steps below to backup recorded video:

a. Select the target files.

- To backup all recorded video of a selected device: **Right-click** the device and click **Backup**.

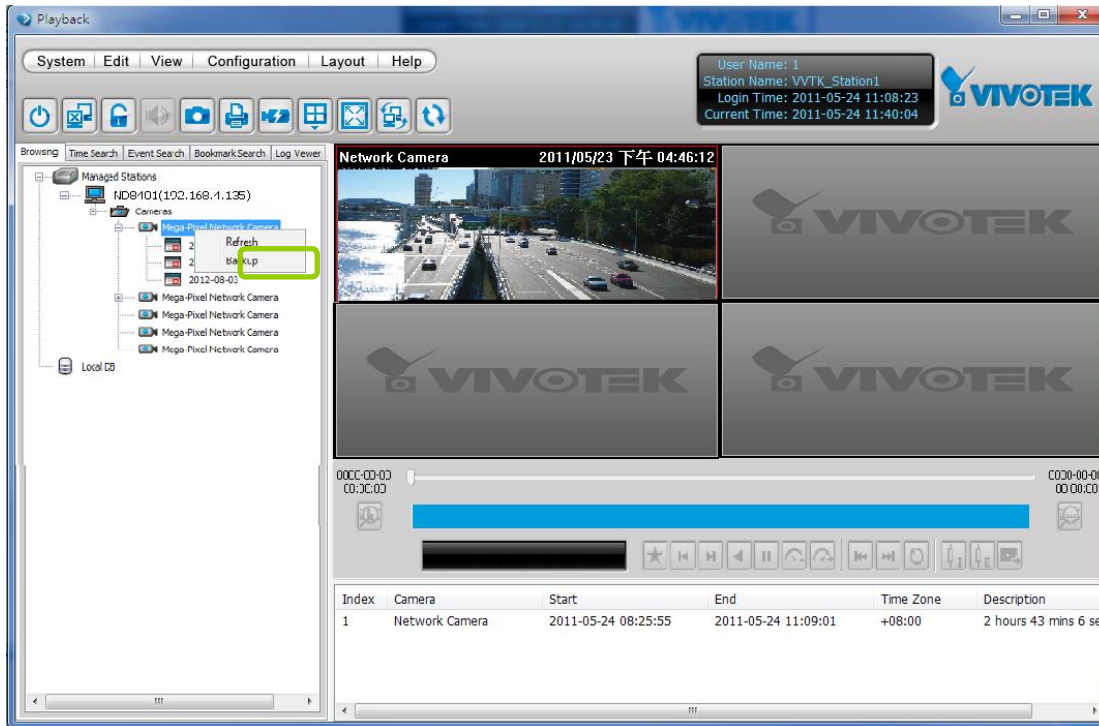

- To backup all recorded video of the day: **Right-click** the option “date” and click **Backup** (or select the date and click the **Backup** button below).

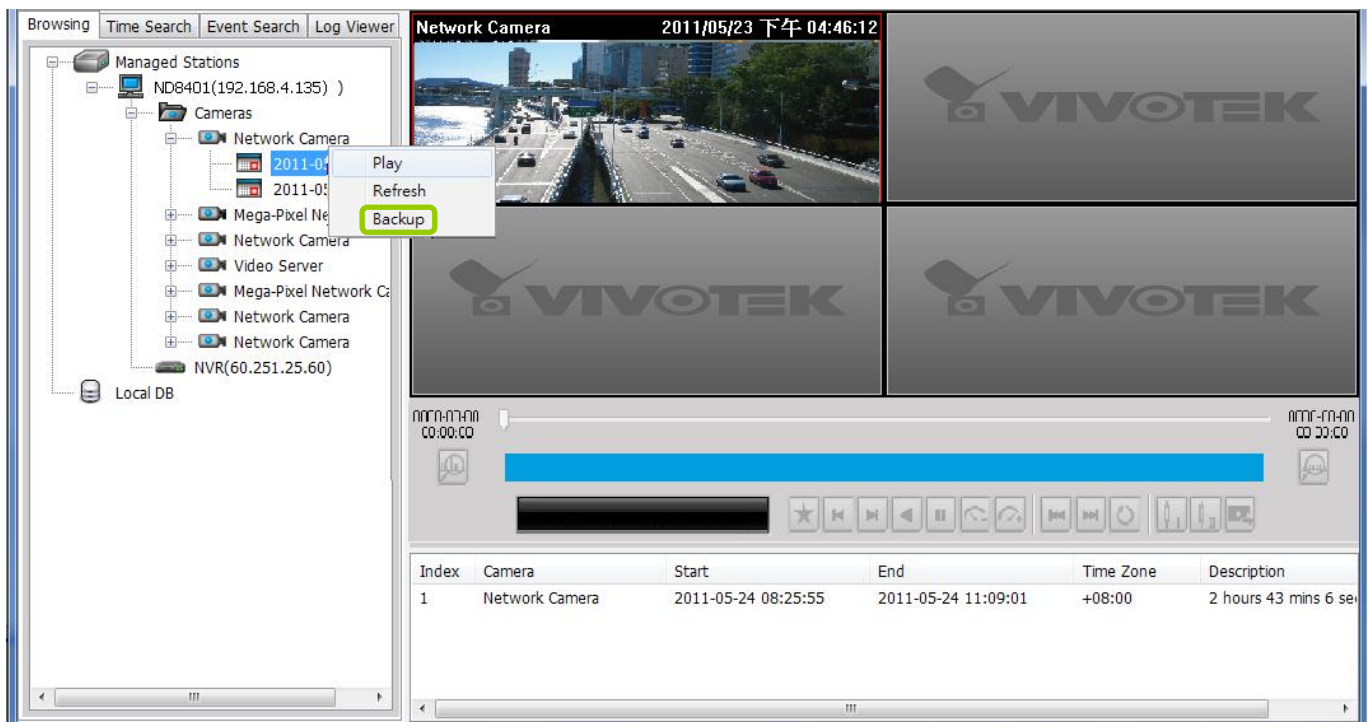



- To backup part of the recorded video of the day: Select the date and choose the video clip(s) from video clip window. Then **right-click** the selected option(s) and click **Backup**. Note: Use the combination of the **Shift** key and left mouse click to select multiple video clips.

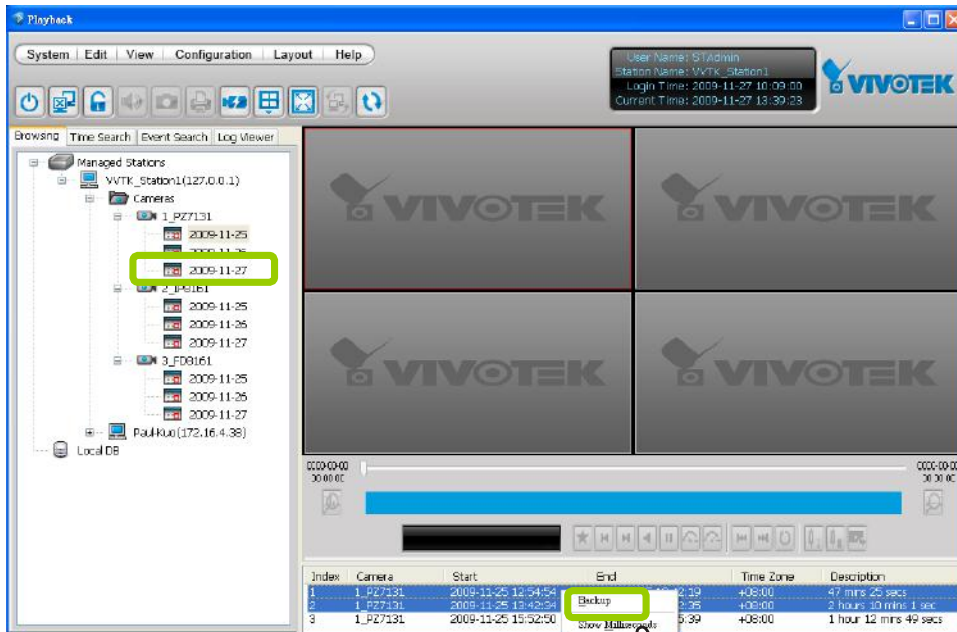

- b. A **Backup Settings** window will pop up. Specify the time span and select a storage path, then click **Backup**. The system will start to backup and popup a window showing the backup status.

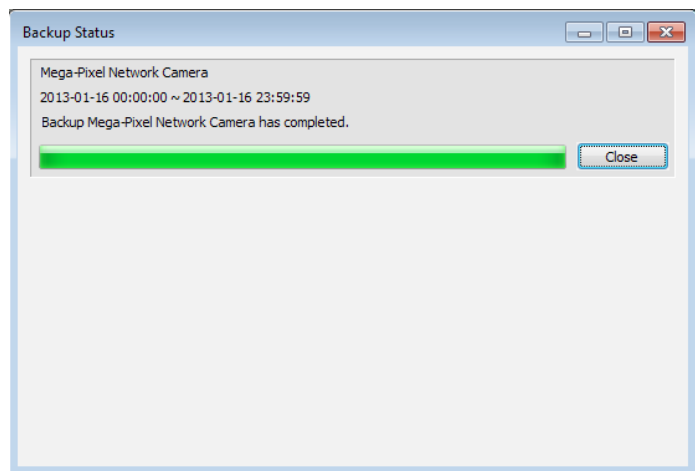
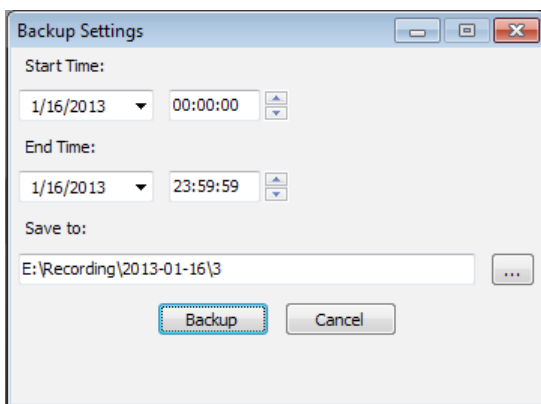

If you close the status window, you can also open it again by clicking **View > Backup Status**.

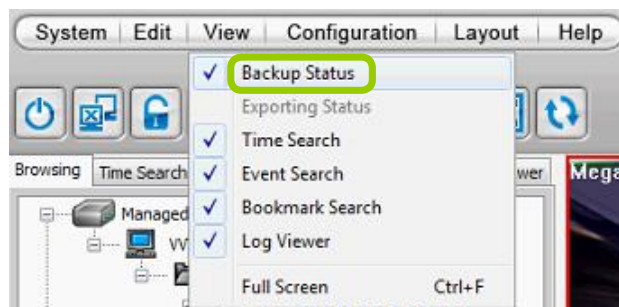

- d. When the backup is complete, you will see an information dialog. The recorded data will be restored in the specific folder.

## How to View Backup Files

The VAST Playback also allows users to playback backup files, including **Schedule Backup** by VAST LiveClient and **Recorded Data Backup** by VAST Playback.

Please follow the steps below to view backup files:

- a. **Right-click** Local DB and click **Add**.
- b. A **Load Backup File** window will pop up as shown below. Select the **\*.dif** file to upload.

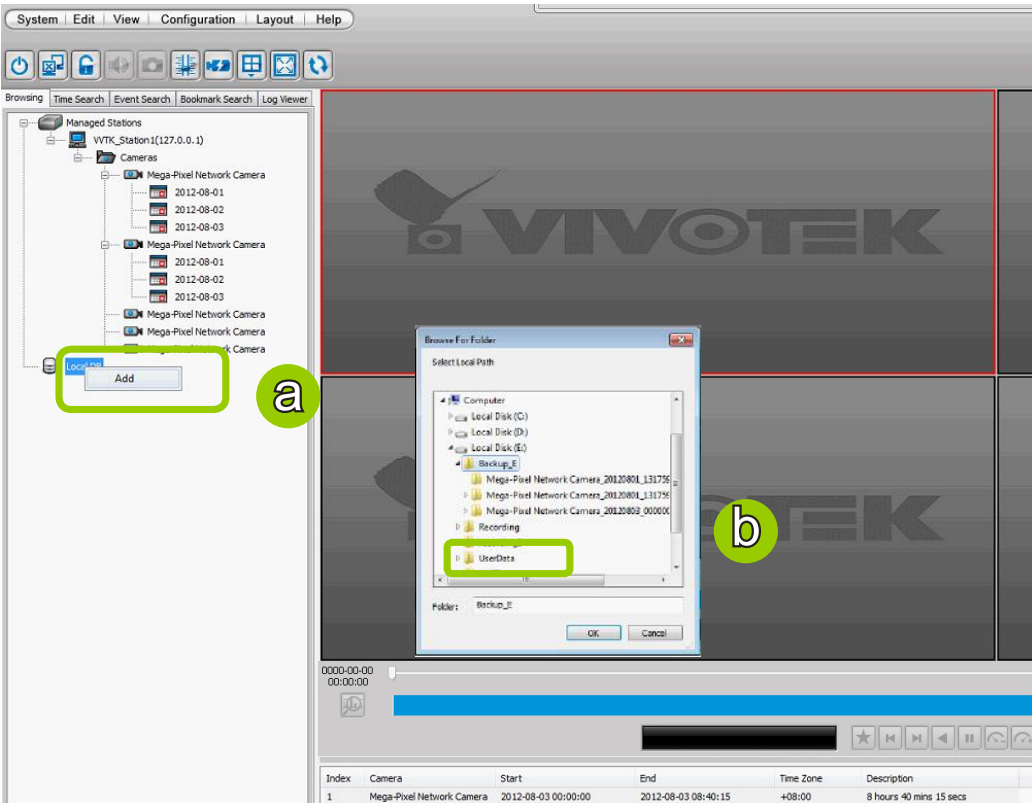

- c. The following is an example of uploaded file, and you can **double-click** it or **drag-and-drop** it to a video cell to playback.

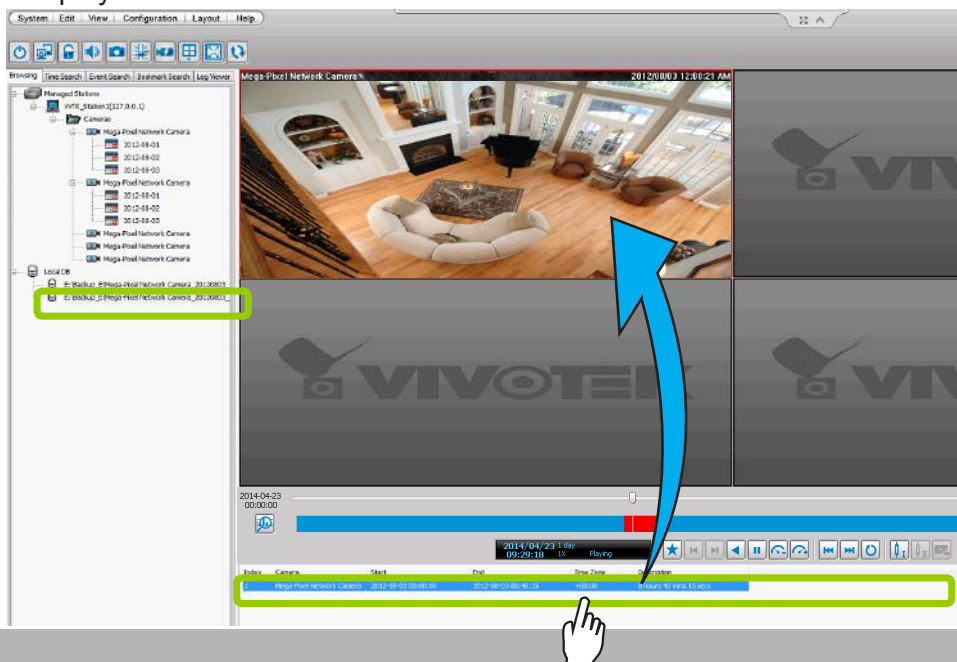



If you want to playback the backup files from the local database, you can also click **Working Offline** in the Login Window without the account information. The VAST Playback will launch as shown below.

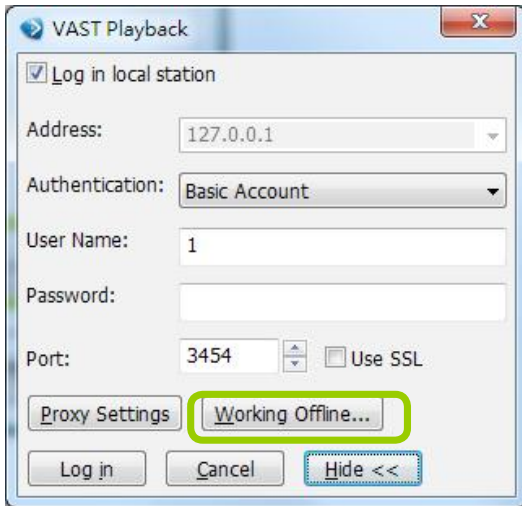

No user account information required

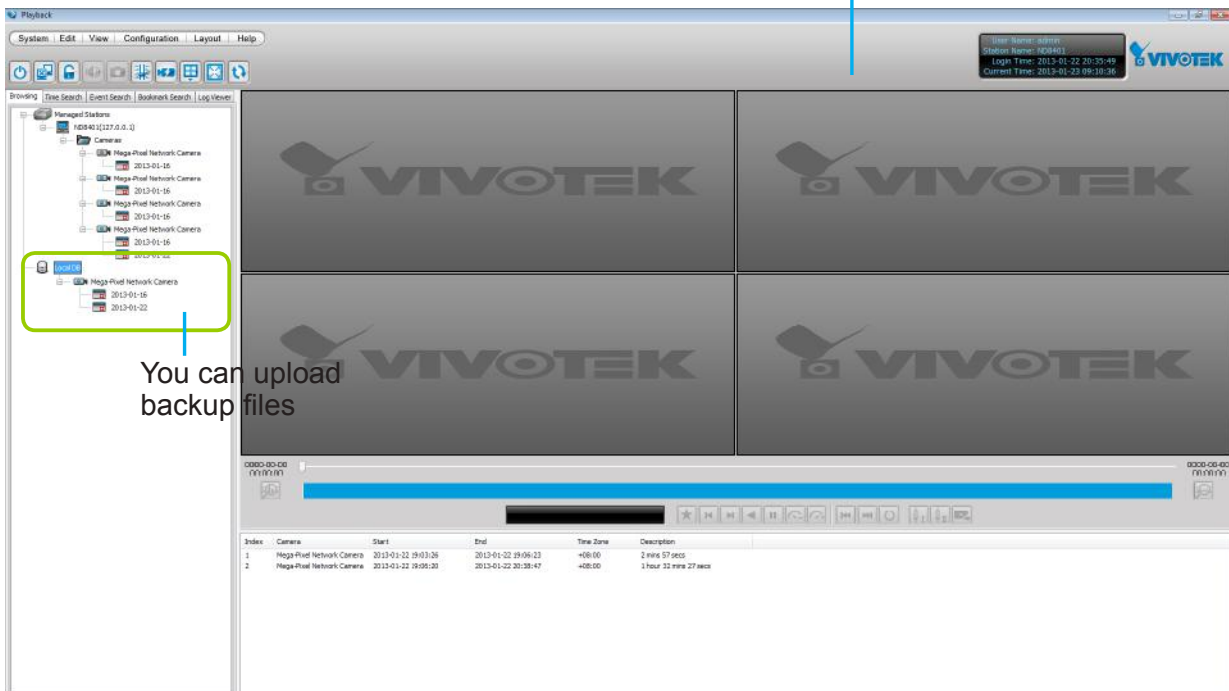

## Model-specific Functions (FE Series Fisheye)

The VAST Playback program offers model-specific functions through a right-click menu. For example, if you playback a video clip made from an FE8171V fisheye camera, a right-click on the playback screen will bring up the Display mode options. You can even exert mouse control while playing a recorded video. You can zoom in, zoom out, and change the view angle as if you are investigating a 3D scenario kept in a recorded point in time.

Note that ePTZ functions via the mouse control only takes place in a Regional view, e.g., the 1R or 1O3R mode.

The **Display mode** options and **mouse control** methodologies are identical to those described on page 74 and the following pages.

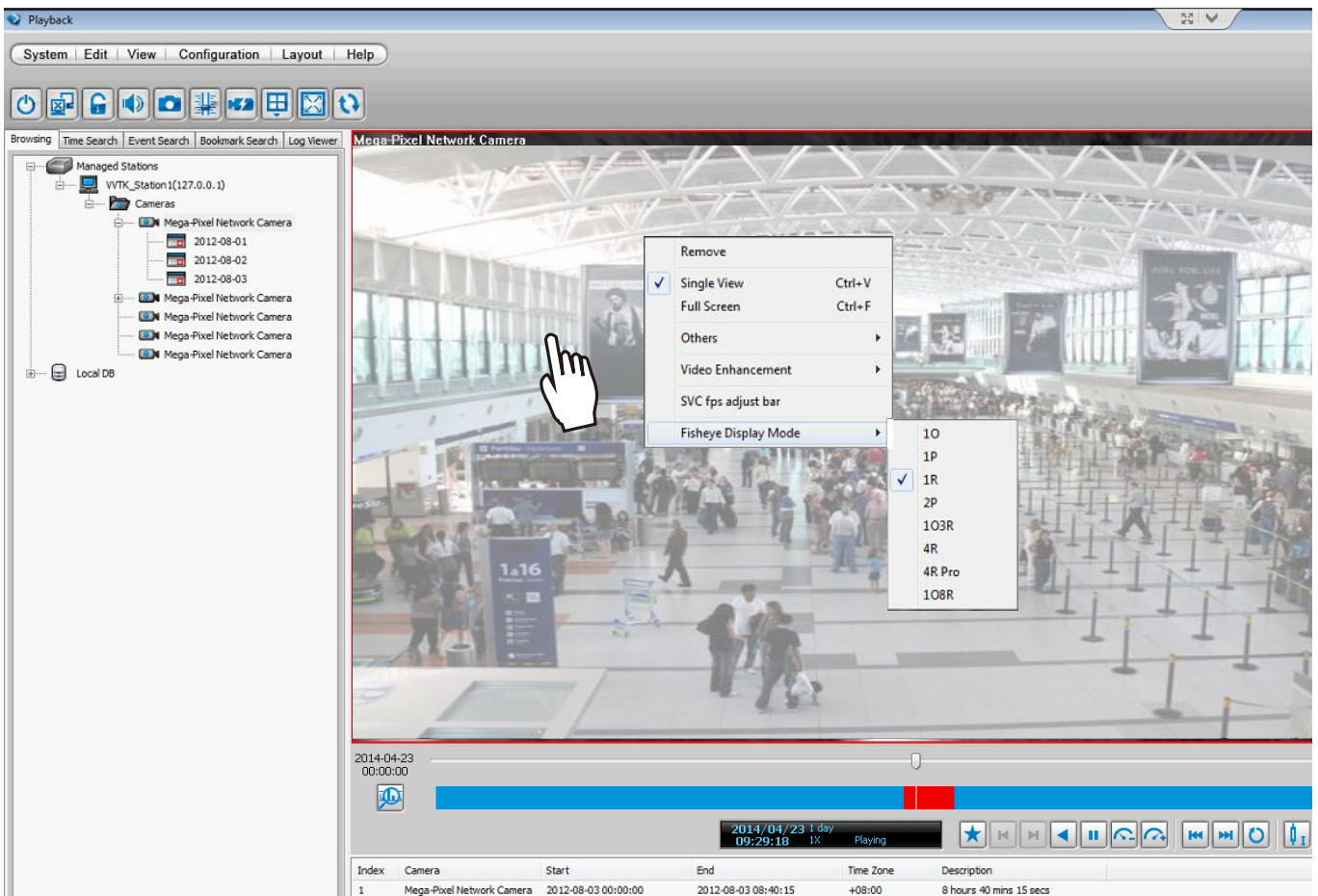

To configure the SVC-related feature:

1. Right-click on the playback window of an SVC-enabled camera. Select **SVC fps adjust bar**.

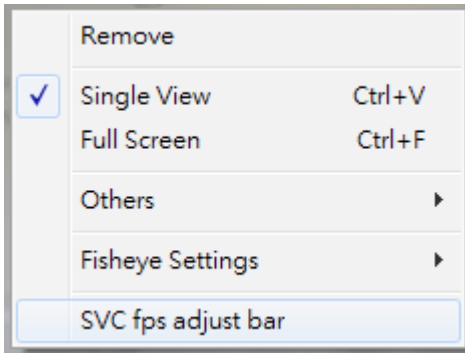

2. A slide bar will appear above the view cell. Click and drag the slide bar. A numeric indicator will display the current selection. See below for the frame rates represented by the numeric indicator. Please refer to page 52 for the introduction of this feature. Changing the SVC value takes immediate effect on the number of frames per second shown with the video being played.

Indicator	Frame rate per second (fps)
Maximum	30
7	26
6	22
5	18
4	12
3	8
2	4
1	1
Minimum	1/4

## How to Search for a Video Clip in a Specific Period of time

Please follow the steps below to use **Time Search** function:

a. Open the **Time Search** page.

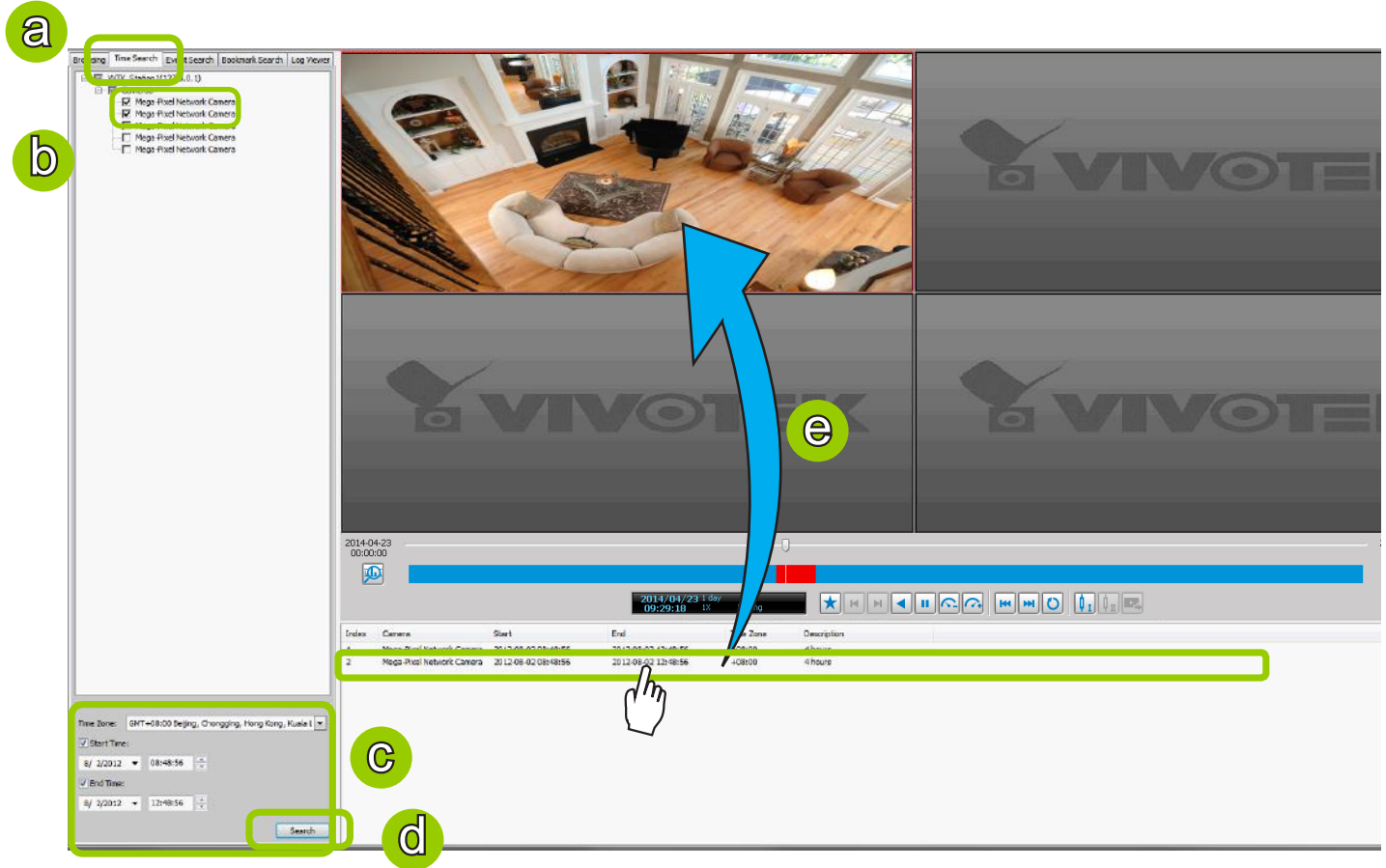

b. Select the target station(s)/device(s) that you want to search for video clips.

c. Specify the time span. You can choose to set up the start time only, the end time only, or both the start time and end time. The search results will only include the video clips within the time span. If you uncheck both the start time and end time, the search results will include all video clips recorded by the selected device(s).

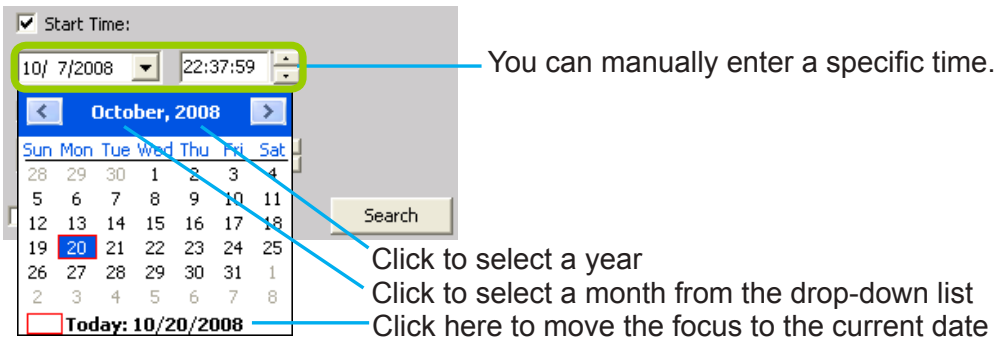

d. Click **Search** to start time search.

e. View the retrieved video clips.

## How to Add a Bookmark

Bookmark is a convenient tagging function that allow your to pinpoint and extract a 20-second video clip from out of a video recording. When you see something of your interest while browsing through a recorded video

1. Click on the  Bookmark button,
2. Enter a name for the bookmark, such as "thief spotted."
3. You may enter a short description in the Description field. You may also search for the bookmarks you created later on.

A bookmark comprises a video clip starting from 10 seconds of before and ends at 10 seconds after the point in time you selected.

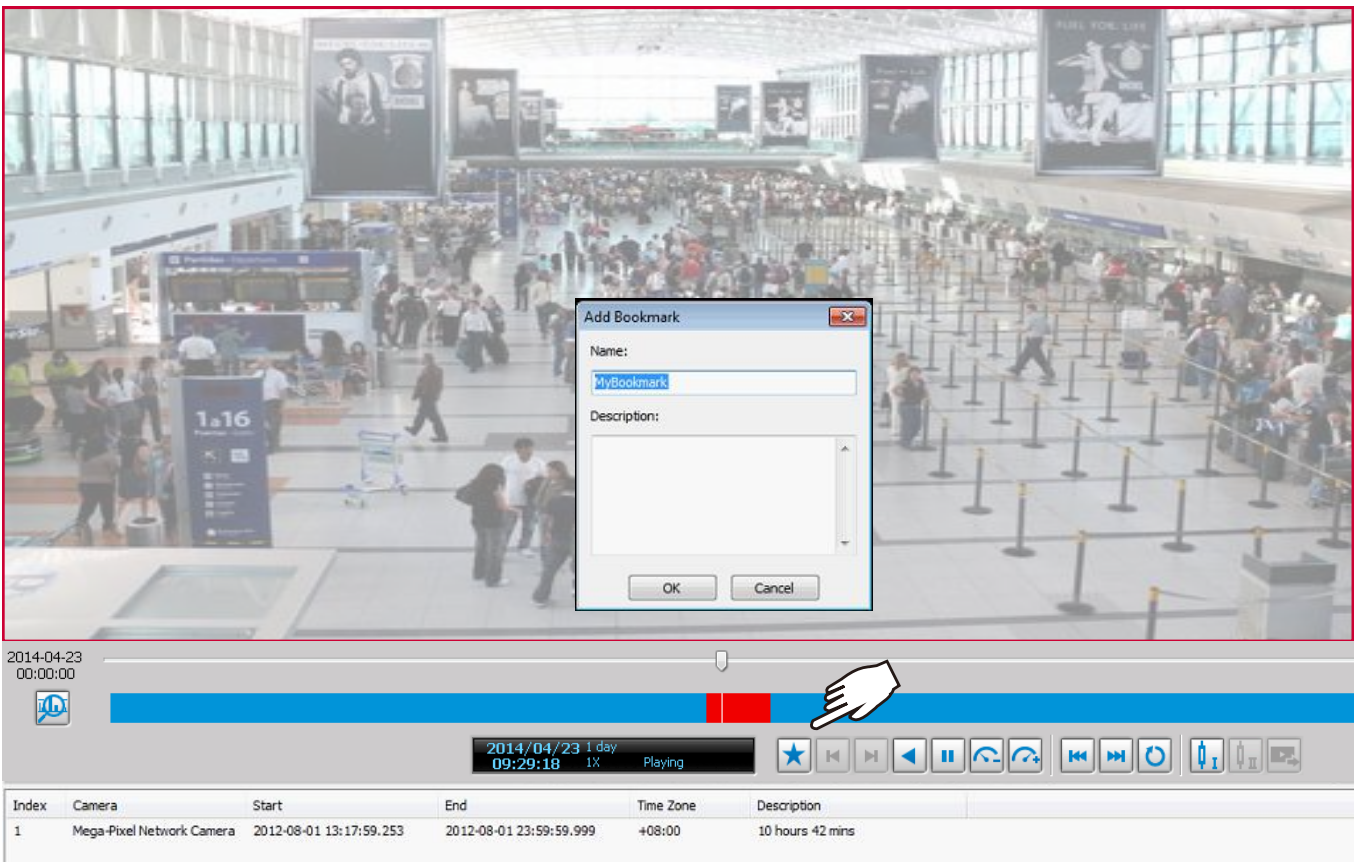

Index	Camera	Start	End	Time Zone	Description
1	Mega-Pixel Network Camera	2012-08-01 13:17:59.253	2012-08-01 23:59:59.999	+08:00	10 hours 42 mins

Please refer to page 231 for how to search for bookmarks.

## How to Search for Events

The VAST Playback program offers users an intuitive event search engine for retrieving video clips from the database of recorded videos based on different search criteria such as motion, IVA, or DI events.

Please follow the steps below to search for recorded events:

a. Open the **Event Search** page.

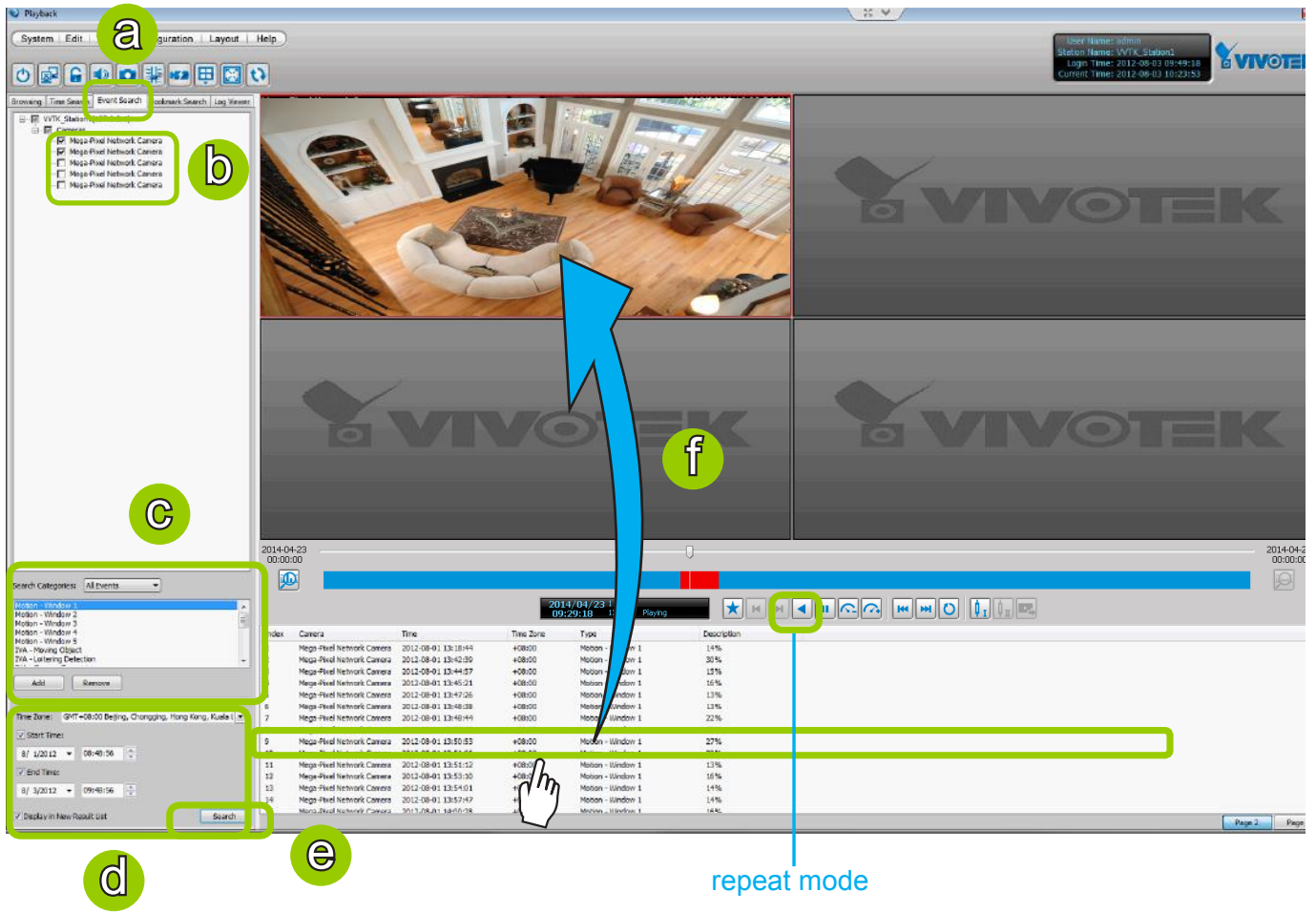

- b. Select the target station(s)/device(s) that you want to search for events.
- c. Specify the **Event Category**. For detailed information, please refer to **Select Event Category** on the following page.
- d. Specify the time span for event search. You can choose to set up the start time only, the end time only, or both the start time and end time. The search results will only include the events within the time span. If you uncheck both the start time and end time, the search results will include all events from the selected device(s). Please refer to step c. on the previous page for detailed information.
- e. Start event search. Please refer to page 260 for detailed information.
- f. View the retrieved video clips. **Double-click** on it or **drag-and-drop** it to the video cell. It will playback in repeat mode.

Note: The length of each video clip will depend on your settings of pre-event time & post-event time for the recording storage. The default setting is **20 seconds**. For more information, please refer to page 137 for detailed information.



## Select Event Category

The following introduces the event search categories: **All Events**, **All Motion Events**, **All IVA events**, **All DI Events**, **Named DI Events**, **PIR**, **Tampering**, **Temperature**, **Video Loss/Restore**, **IR Trigger/Normal**, and **P-PTZ**. You can also add or remove customized events from the list.

### Event Category- All Events

If you select the **All Events** category, all of the events including motion detection, digital input, and intelligent video analysis, PIR, tamper detection, and temperature alarm will be listed in the search results. You can click **Add** or **Remove** to change the search criteria options.

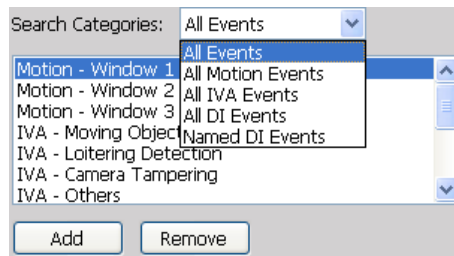

### Event Category- All Motion Events

If you select the **All Motion Events** category, all detected motion events will be included in the search. You can click **Add** or **Remove** to change the search criteria options.

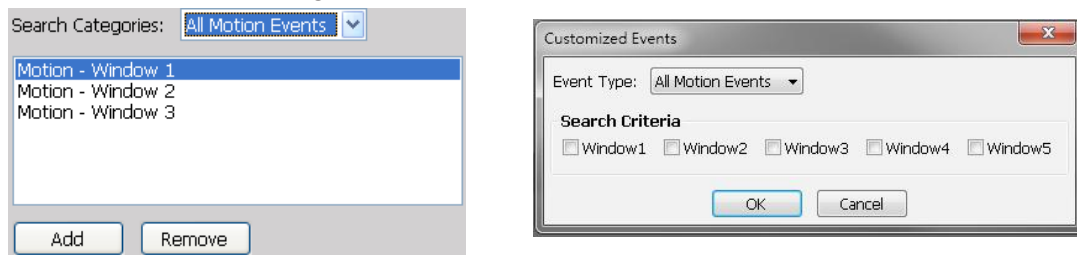

The parameters of the motion detection windows, such as motion percentage and the time of occurrence are also recorded in the database of the server. If you wish to change the parameters of the motion detection windows such as the position, size, detection sensibility, and motion percentage, please link to the camera's Configuration page to modify the values.

Enable motion detection



### Event Category- All IVA events

If you select the **All IVA events** category, all detected IVA events will be included in the search. Cameras with embedded intelligent video content analysis are capable of detecting IVA events such as moving objects, loitering, and tamper detection.

The embedded video content analysis, superior to the conventional motion detection function, is capable of distinguishing between creature's motions, static backgrounds or natural movements such as swaying trees, waves or sunsets to prevent false alarms from environmental noises.

With camera tamper detection, it can detect incidents such as camera redirection, blocking or defocusing of cameras, or even spray-paint. Additionally, a suspicious object in the pre-defined detection region will trigger alarms once the dwell time of the object is longer than the given time.

You can click **Add** or **Remove** to change the search criteria items.

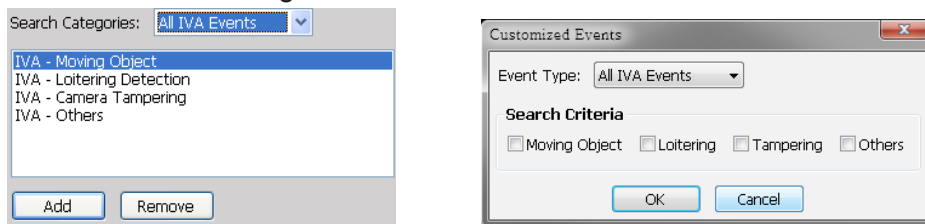

If you want to change the parameters of IVA, such as the detection region, loitering duration, etc, please link to the camera's Configuration page to modify the values.

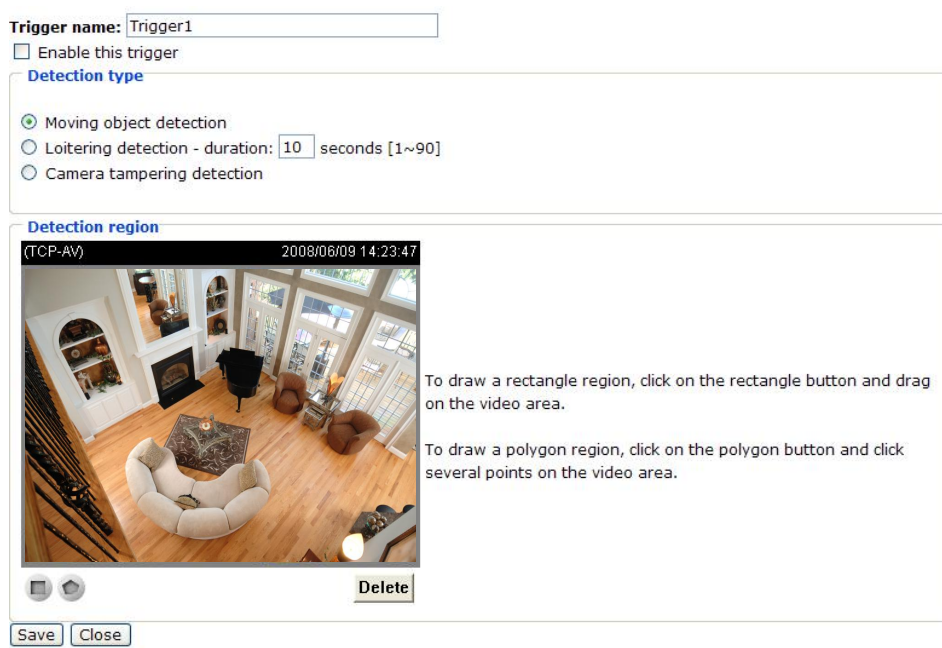

### Event Category- All DI Events

If you select **All DI Events** category, all triggered DI signals will be included in the search. The DI events signify that there is a Digital-Input signal detected by the camera; its corresponding information such as DI-Trigger or DI-Normal signal and the time of occurrence are also transmitted and recorded in the database of the server.

You can click **Add** or **Remove** to change the search criteria options.

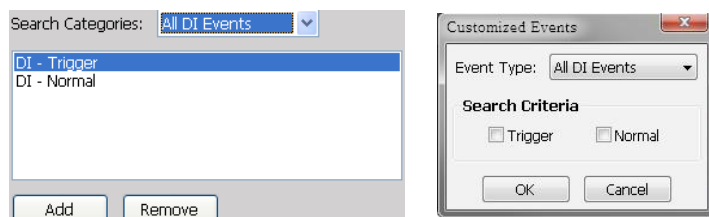

For more information about DI/DO settings on the connected devices, please refer to page 109 for detailed illustration.

## Event Category- Named DI Events

This category allows you to select only **Named DI Events**--the DI device which you have renamed in the LiveClient. Please refer to Association Management on page 109 for more information about how to rename DI device.

Click **OK** and fill in the name you want to search on the left window.

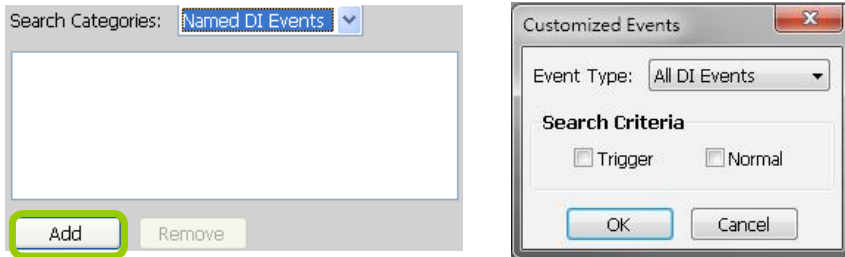

The new search criteria will be displayed in the search categories column as shown below. You can click **Add** or **Remove** to change the search criteria options.

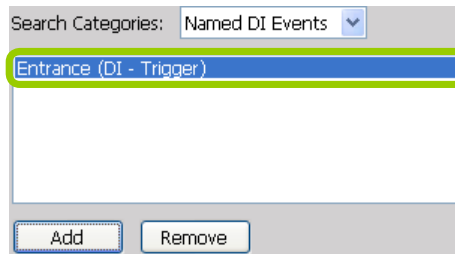

## Start Event Search

After you specify all of the search criteria mentioned above, check/uncheck **Display in new result list** and click **Search** to begin event search.

- If **Display in new result list** is unchecked, all search results will be displayed on the original event list window as shown below.

Search Categories: All Motion Events

Motion - Window 1  
Motion - Window 2  
Motion - Window 3

Add Remove

Time Zone: GMT+08:00 Beijing, Chongqing, Ho

Start Time:  
2009/11/30 09:26:43

End Time:  
2009/11/30 10:26:43

Display in New Result List Search

Index	Camera	Time	Time Zone	Type	Description
1	Mega-Pixel Network Ca...	2014-09-25 14:01:20	+08:00	Motion - Window 1	19%
2	Mega-Pixel Network Ca...	2014-09-25 14:02:39	+08:00	Motion - Window 1	43%
3	Mega-Pixel Network Ca...	2014-09-25 14:15:03	+08:00	Motion - Window 1	38%
4	Mega-Pixel Network Ca...	2014-09-25 14:17:37	+08:00	Motion - Window 1	37%
5	Mega-Pixel Network Ca...	2014-09-25 14:18:03	+08:00	Motion - Window 1	35%
6	Mega-Pixel Network Ca...	2014-09-25 14:18:16	+08:00	Motion - Window 1	28%
	Mega-Pixel Network Ca...	2014-09-25 14:18:32	+08:00	Motion - Window 1	39%

Unchecked

Only one page

- In the above picture, The **Type** field in the search result page shows the event category, and the **Description** field displays the motion **percentage** of the detection window. Please refer to page 257 for more information about Motion Events.

- If you select **Display in new result list** and click **Search**, the search results will be displayed on a new page as shown below. This allows you to place the search results of each search category on an individual page. You can set up to 5 pages in the event list window.

Search Categories: All Events

DI - Trigger  
DI - Normal  
PIR  
Tampering  
Temperature - Trigger  
Temperature - Normal

Add Remove

Time Zone: GMT+08:00 Beijing, Chongqing, Ho

Start Time:  
2009/11/30 09:26:43

End Time:  
2009/11/30 10:26:43

Display in New Result List Search

Index	Camera	Time	Time Zone	Type	Description
1	3_FD8161	2009-11-30 09:44:54	+08:00	PIR	Trigger
2	3_FD8161	2009-11-30 09:44:54	+08:00	PIR	Trigger
3	3_FD8161	2009-11-30 09:44:54	+08:00	PIR	Trigger
4	3_FD8161	2009-11-30 09:44:55	+08:00	PIR	Trigger
5	3_FD8161	2009-11-30 09:44:56	+08:00	PIR	Trigger
6	3_FD8161	2009-11-30 09:44:56	+08:00	PIR	Trigger

Checked

Page 2 Page 1

You can set up to 5 pages.



The P-PTZ event type refers to those triggered by the Auto Tracking actions.

## Backup the Event Videos

Please follow the steps below to backup the event videos on the results list:

- a. Select the video clips you want to backup. You can select more than one video clip.
- b. **Right-click** the selected video clips and click **Backup**.

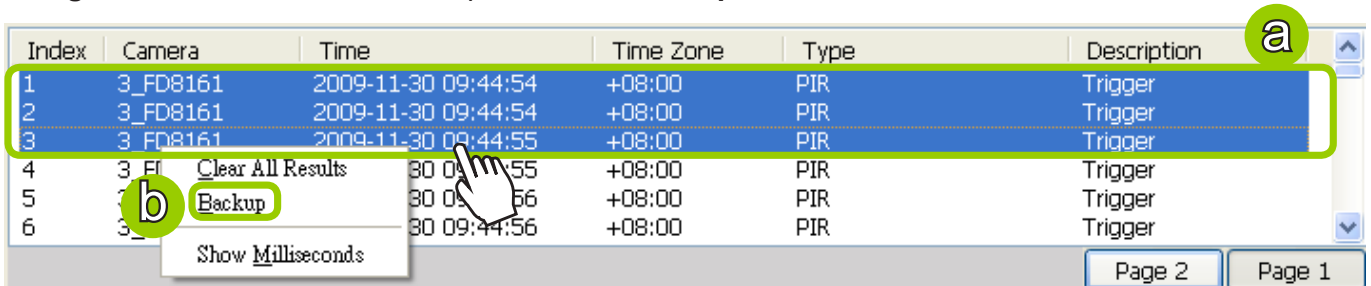

The screenshot shows a table with columns: Index, Camera, Time, Time Zone, Type, and Description. Rows 1, 2, and 3 are selected and highlighted in blue. A context menu is open over these rows, with the 'Backup' option highlighted. A green circle 'a' is in the top right corner of the table, and a green circle 'b' is next to the 'Backup' option in the menu. At the bottom right of the table are 'Page 2' and 'Page 1' buttons.

Index	Camera	Time	Time Zone	Type	Description
1	3_FD8161	2009-11-30 09:44:54	+08:00	PIR	Trigger
2	3_FD8161	2009-11-30 09:44:54	+08:00	PIR	Trigger
3	3_FD8161	2009-11-30 09:44:55	+08:00	PIR	Trigger
4	3_FD8161	2009-11-30 09:44:55	+08:00	PIR	Trigger
5	3_FD8161	2009-11-30 09:44:56	+08:00	PIR	Trigger
6	3_FD8161	2009-11-30 09:44:56	+08:00	PIR	Trigger

- c. A **Backup Settings** window will pop up. For more information about how to set up the Backup Settings, please refer to page 248. For more information about how to view backup files, please refer to page 250 for detailed illustration.

## How to Search for a Bookmark

Please follow the steps below to use **Bookmark Search** function:

- Click on the tabbed menu to open the **Bookmark Search** page.
- Select the cameras which have video clips you have placed bookmarks on.

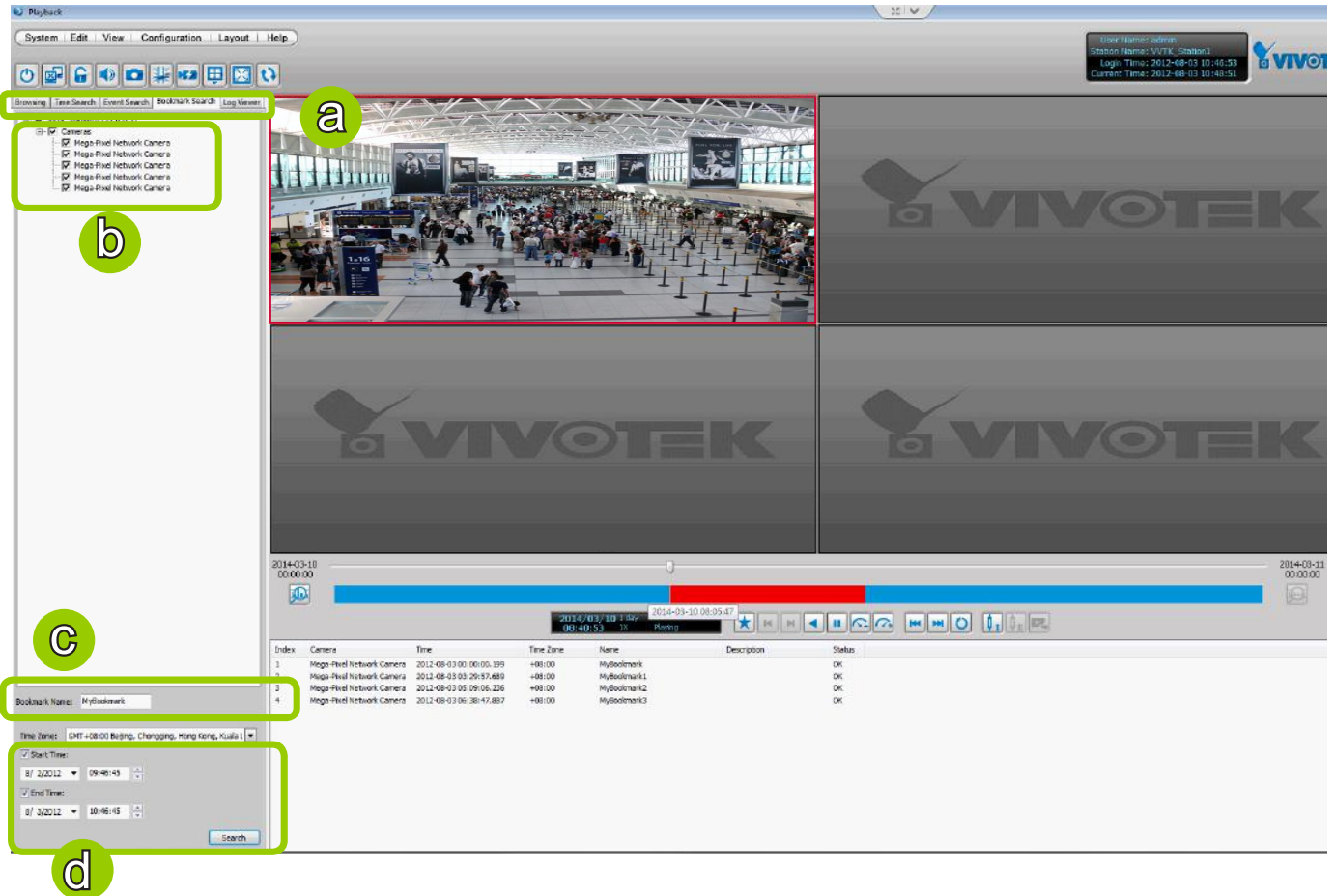

c. Enter the name of bookmark.

d. Specify a range of time during which the video streams were recorded and its points in time were bookmarked.

Click **search**. You can then click on a bookmark to display the short video clip extracted from within the recorded video.

To remove an existing bookmark, left-click to select an entry, and then right-click to display the Delete button. Bookmarks will be indicated as "Invalid" if the videos where the bookmarks were appended were erased, e.g., when the original recording was erased by cyclic recording.

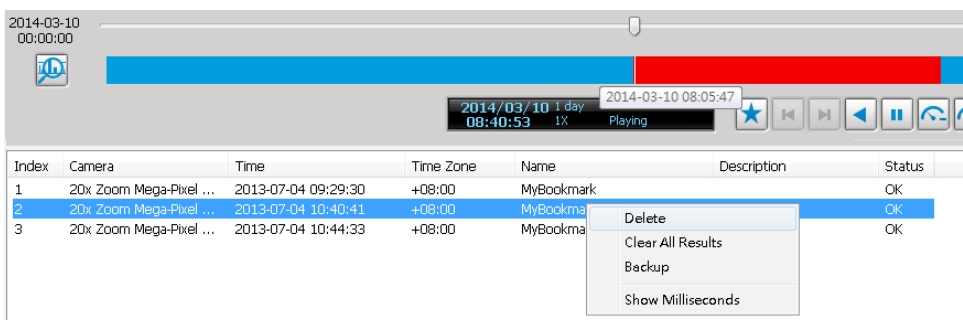

## How to Search Logs

The VAST Playback program offers a convenient log engine for searching all local logs based on different search criteria such as log category, log type, and log level. The search results will be displayed in the log viewer window along with the detailed log history.

Please follow the steps below to search logs:

- a. Open the **Log Viewer** page.
- b. Select the target station where you want to search logs.
- c. Specify the **Log Category**. For detailed information, please refer to **Select Log Category** on page 264.
- d. Specify the **User Account**. If you have added other user accounts to the station, you can select one to search its login history. For detailed information about user account, please refer to **How to Manage User Accounts** on page 100.
- e. Specify the **Search Result**. Select **All** to display all search results; select **Success** to display successful log activities only; select **Fail** to display failed log activities only.
- f. Specify the **Log Type**. For detailed information, please refer to **Select Log Type** on page 264.
- g. Specify the **Log Level**. For detailed information, please refer to **Select Log Level** on page 264.
- h. Specify the search time span. You can check the start time only, the end time only, or both the start time and end time. The search will only include the events within the time span. If you uncheck both the start time and end time, the search will include all events saved by the server. Please refer to page 254 for detailed information.
- i. Start the log search and the results will be displayed on the log list window.

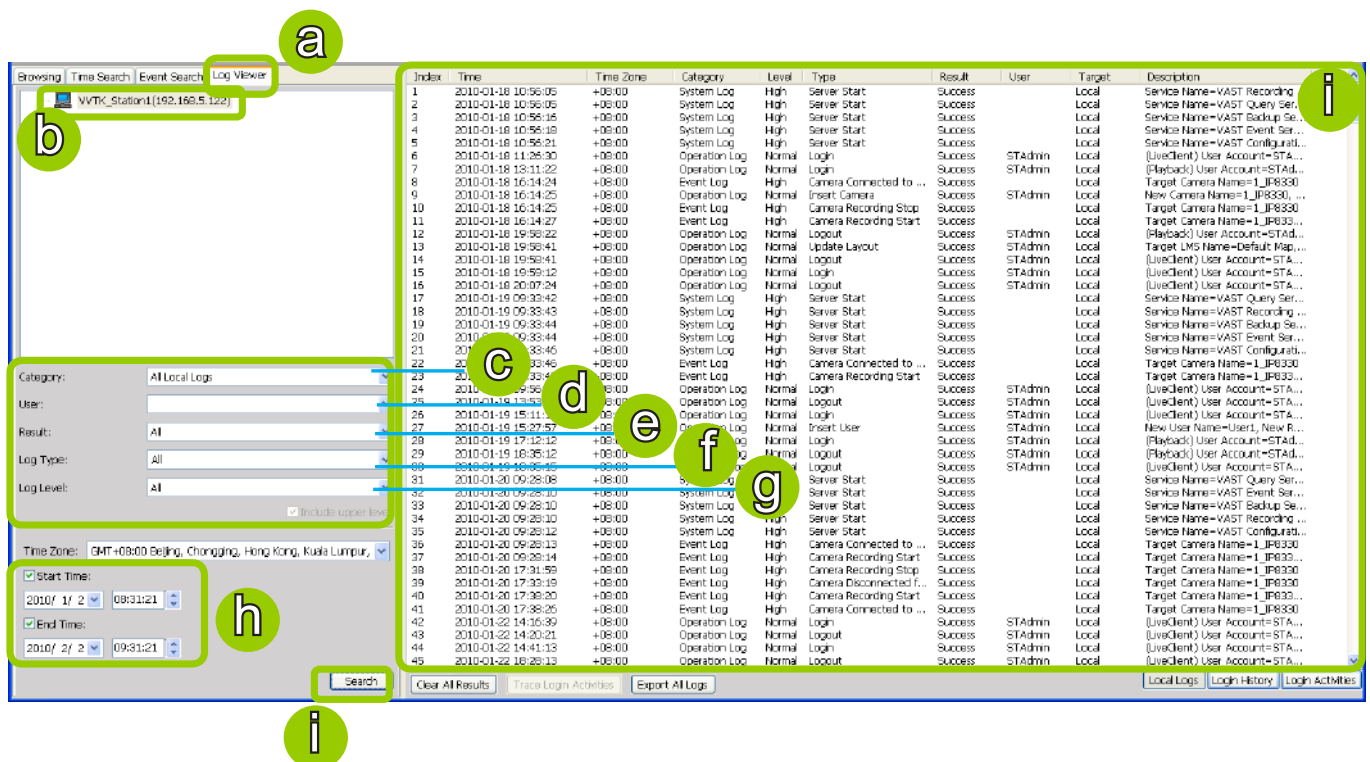

## Select Log Category/Log Type/Log Level

The following table shows the breakdown of log category, level, and type. The search results will be different according to your selections.

Log Categories	Log Levels	Log Types
Operation Log	Normal	Login / Logout Insert User Update User Name Update User Password Update User Privilege Delete User Insert Station Update Station Information Update Station Name Delete Station Insert Camera Update Camera Information Delete Camera Set Recording Group Insert Recording Schedule / Update Recording Schedule / Delete Recording Schedule Insert Event Management / Update Event Management / Delete Event Management Insert Recording Group / Update Recording Group / Delete Recording Group Insert Recording Path / Update Recording Path / Delete Recording Path Insert Camera to the Recording Group Update Camera information in the Recording Group Delete Camera from the Recording Group Move Recording Path Move Camera to another Recording Group Insert Layout / Update Layout / Delete Layout Set Digital Output Update Scheduled Backup Update Server Port Set Proxy Server Set UPNP Set DDNS Server Create Directory / Rename Directory / Delete Directory Insert SMTP Server / Update SMTP Server / Delete SMTP Server Insert Network Storage Device / Update Network Storage Device / Delete Network Storage Device Set GSM Modem Set DI/DO Rename Set Relay Settings Update License Information Update Web Access Information Insert Matrix Recipient / Insert Matrix Recipient Information / Delete Matrix Recipient
	High	Manually Begin Recording Manually Stop Recording
	Low	Camera PTZ, Iris, Focus, Pan, Patrol Control Click on Image Select Preset Location
System Log	High	Server Start / Server Stop Trial Expired Key Dongle Lost Virtual Memory Low Network Lost / Storage lost



Log Categories	Log Levels	Log Types
Event Log	High	Camera Disconnected from the Server / Camera Connected to the Server Parent Station Connection Lost / Parent Station Connection Restore Sub-station Disconnected / Sub-station Connected Camera Recording Start / Camera Recording Stop Start Scheduled Backup / Stop Scheduled Backup Event Trigger

### Search All Local Logs

Log Category  
Log Level  
Log Type

Index	Time	Time Zone	Category	Level	Type	Result	User	Target	Description
1	2009-12-09 09:50:54	+08:00	System Log	High	Server Stop	Success		Local	Service Name=VAST Backup ...
2	2009-12-09 09:50:54	+08:00	System Log	High	Server Stop	Success		Local	Service Name=VAST Event S...
3	2009-12-09 09:50:55	+08:00	System Log	High	Server Stop	Success		Local	Service Name=VAST Query S...
4	2009-12-09 09:50:55	+08:00	System Log	High	Server Stop	Success		Local	Service Name=VAST Recordi...
5	2009-12-09 09:50:55	+08:00	System Log	High	Server Stop	Success		Local	Service Name=VAST Configur...
6	2009-12-09 09:50:56	+08:00	Event Log	High	Camera Disconnecte...	Success		Local	Target Camera Name=1_PZ7...
7	2009-12-09 09:50:56	+08:00	Event Log	High	Camera Disconnecte...	Success		Local	Target Camera Name=2_IP8...
8	2009-12-09 09:51:42	+08:00	System Log	High	Server Start	Success		Local	Service Name=VAST Recordi...
9	2009-12-09 09:51:44	+08:00	System Log	High	Server Start	Success		Local	Service Name=VAST Query S...
10	2009-12-09 09:51:47	+08:00	System Log	High	Server Start	Success		Local	Service Name=VAST Event S...
11	2009-12-09 09:51:48	+08:00	System Log	High	Server Start	Success		Local	Service Name=VAST Backup ...
12	2009-12-09 09:51:50	+08:00	System Log	High	Server Start	Success		Local	Service Name=VAST Configur...
13	2009-12-09 09:51:51	+08:00	Event Log	High	Camera Connected t...	Success		Local	Target Camera Name=2_IP8...
14	2009-12-09 09:51:51	+08:00	Event Log	High	Camera Connected t...	Success		Local	Target Camera Name=1_PZ7...
15	2009-12-09 09:51:52	+08:00	Event Log	High	Camera Recording Stop	Success		Local	Target Camera Name=3_FD8...

Click to remove all search results from the list  
Click to export all search results from the list

### Search Login History

Select **Login History** from the log category field and click the **Search** button below, the search results, including all login logs, will be displayed on the Login History page.

Browsing Time Search Event Search Log Viewer

VVTK\_Station1(192.168.5.122)

Category: Login History

User: [ ]

Result: All

Log Type: All

Log Level: All

Include upper level

Time Zone: GMT+08:00 Beijing, Chongqing, Hong Kong

Start Time: 2010/ 2/ 1 08:31:21

End Time: 2010/ 2/ 2 09:31:21

Index	User	Login Time	Login Result	Logout Time	Logout Result	Time Zone	Description
1	STAdmin	2010-02-01 09:41:38	Success	2010-02-01 11:48:52	Success	+08:00	Playback
2	STAdmin	2010-02-01 11:05:53	Success	2010-02-01 20:16:21	Success	+08:00	LiveClient
3	STAdmin	2010-02-01 11:48:55	Success	2010-02-01 20:16:15	Success	+08:00	Playback
4	STAdmin	2010-02-02 09:31:04	Success			+08:00	LiveClient

## Search Login Activities

This function allows you to search the operations the user performed during the login period of time. You can search for login activities on the Local Logs or Login History page.

■ Search Login Activities on the Local Logs page:

- Click on the **Local Logs** page.
- Select a login/logout option from the list.
- Click **Trace Login Activities** (or you can **right-click** the selected login/logout option on the list, then click **Trace Login Activities**).

Index	Time	Time Zone	Category	Level	Type	Result	User	Target	Description
1	2010-01-18 10:56:05	+08:00	System Log	High	Server Start	Success		Local	Service Name=VAST Recording ...
2	2010-01-18 10:56:05	+08:00	System Log	High	Server Start	Success		Local	Service Name=VAST Query Ser...
3	2010-01-18 10:56:16	+08:00	System Log	High	Server Start	Success		Local	Service Name=VAST Backup Se...
4	2010-01-18 10:56:18	+08:00	System Log	High	Server Start	Success		Local	Service Name=VAST Event Ser...
5	2010-01-18 10:56:21	+08:00	System Log	High	Server Start	Success		Local	Service Name=VAST Configurati...
6	2010-01-18 11:26:30	+08:00	Operation Log	Normal	Login	Success	STAdmin	Local	(LiveClient) User Account=STA...
7	2010-01-18 13:11:22	+08:00	Operation Log	Normal	Login	Success	STAdmin	Local	(Playback) User Account=STAd...
8	2010-01-18 16:14:24	+08:00	Event Log	Normal	Camera	Success		Local	Target Camera Name=1_IP8330, ...
9	2010-01-18 16:14:25	+08:00	Operation Log	Normal	Insert	Success	STAdmin	Local	New Camera Name=1_IP8330, ...
10	2010-01-18 16:14:25	+08:00	Event Log	Normal	Camera	Success		Local	Target Camera Name=1_IP8330
11	2010-01-18 16:14:27	+08:00	Event Log	Normal	Camera recording start	Success		Local	Target Camera Name=1_IP8330...
12	2010-01-18 19:58:22	+08:00	Operation Log	Normal	Logout	Success	STAdmin	Local	(Playback) User Account=STAd...
13	2010-01-18 19:58:41	+08:00	Operation Log	Normal	Update Layout	Success	STAdmin	Local	Target LMS Name=Default Map,...
14	2010-01-18 19:58:41	+08:00	Operation Log	Normal	Logout	Success	STAdmin	Local	(LiveClient) User Account=STA...
15	2010-01-18 19:59:12	+08:00	Operation Log	Normal	Login	Success	STAdmin	Local	(LiveClient) User Account=STA...
16	2010-01-18 20:07:24	+08:00	Operation Log	Normal	Logout	Success	STAdmin	Local	(LiveClient) User Account=STA...
17	2010-01-19 09:33:42	+08:00	System Log	High	Server Start	Success		Local	Service Name=VAST Query Ser...

Buttons: Clear All Results, Trace Login Activities, Export All Logs. Navigation: Local Logs, Login History, Login Activities.

d. The search results of the login activities will be displayed on the Login Activities page as shown below.

Index	Time	Time Zone	Category	Level	Type	Result	User	Target	Description
1	2010-01-18 11:26:30	+08:00	Operation Log	Normal	Login	Success	STAdmin	Local	(LiveClient) User Account=STA...
2	2010-01-18 16:14:25	+08:00	Operation Log	Normal	Insert Camera	Success	STAdmin	Local	New Camera Name=1_IP8330, ...
3	2010-01-18 19:58:41	+08:00	Operation Log	Normal	Update Layout	Success	STAdmin	Local	Target LMS Name=Default Map,...
4	2010-01-18 19:58:41	+08:00	Operation Log	Normal	Logout	Success	STAdmin	Local	(LiveClient) User Account=STA...

Buttons: Clear All Results, Trace Login Activities, Export All Logs. Navigation: Local Logs, Login History, Login Activities.

■ Search Login Activities on the Login History page:

- Click on the **Login History** page.
- Select a login/logout option from the list.
- Click **Trace Login Activities** (or you can **right-click** the selected login/logout item on the list and click **Trace Login Activities**).

Index	User	Login Time	Login Result	Logout Time	Logout Result	Time Zone	Description
1	STAdmin	2010-02-01 09:41:38	Success	2010-02-01 11:48:52	Success	+08:00	Playback
2	STAdmin	2010-02-01 11:05:53	Success			+08:00	LiveClient
3	STAdmin	2010-02-01 11:48:55	Success			+08:00	Playback
4	STAdmin	2010-02-02 09:31:04	Success			+08:00	LiveClient

Buttons: Clear All Results, Trace Login Activities, Export All Logs. Navigation: Local Logs, Login History, Login Activities.

d. The search results of the login activities will be displayed on the Login Activities page as shown below.

Index	Time	Time Zone	Category	Level	Type	Result	User	Target	Description
1	2010-02-01 11:05:53	+08:00	Operation Log	Normal	Login	Success	STAdmin	Local	(LiveClient) User Account=STA...
2	2010-02-01 20:16:21	+08:00	Operation Log	Normal	Logout	Success	STAdmin	Local	(LiveClient) User Account=STA...



When you select **All** in the **Log Level** field, the search results will include all log levels. If you select **Low** in the **Log Level** field and select **Including above level** as shown in the picture on the left below, the search results will include all levels of logs. But if you select **Normal** in the **Log Level** field and select **Including above level** as shown in the picture on the right below, the search results will only include **Normal-level** and **High-level** logs.

Log Level:   Including above level

Log Level:   Including above level

## How to Configure Client Settings

On Client Settings, you can configure Snapshot Settings, Export Settings, View Settings, Proxy Settings, and General Settings. It allows you to save snapshots and media files on the local computer.

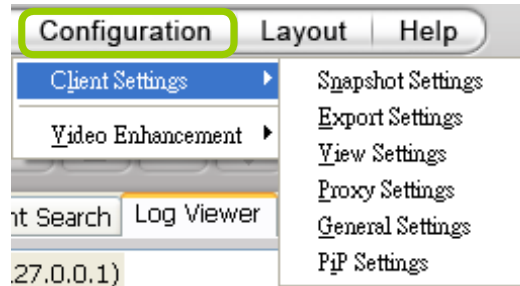

### Snapshot Settings

When you play a recorded video, VAST Playback also allows you to take snapshots. For detailed information about **Snapshot Settings**, please refer to page 179.

### Export Settings

When you playback a recorded video, the VAST server allows you to export part of the recorded video in EXE, 3GP, or AVI format to your local computer. Before exporting a media file, please set up Export Settings first. For detailed information about how to set up EXE, 3GP, and AVI **Export Settings**, please refer to Record Settings on page 181.



The default exporting path is: C:\ProgramData\VIVOTEK Inc\VAST\Client\PlayBack\Export

### Limitations

1. The size of exported footage depends on the file size limitation. When the limitation is reached, files will be concluded regardless of the length of your selection.
2. The Export button will not be available when there is another exporting task.
3. If the time settings on camera and VAST server are inconsistent, the export task will generate files of unexpected length.
4. The minimum export length is 1 minute. The maximum is 150 minutes. However, due to the embedded limitation, the approximate max. file size is 3.7GB.

## Export an EXE/3GP/AVI File

Please follow the steps below to convert part of an EXE/3GP/AVI file of recorded video:

- a. Playback a video clip from which you want to export a media file.
- b. Set a period of time. Move the timeline slider bar to the desired start time and click Marker I . Move the timeline slider bar to the desired end time and click Marker II .



Currently exporting video files from the NVR series is not supported.

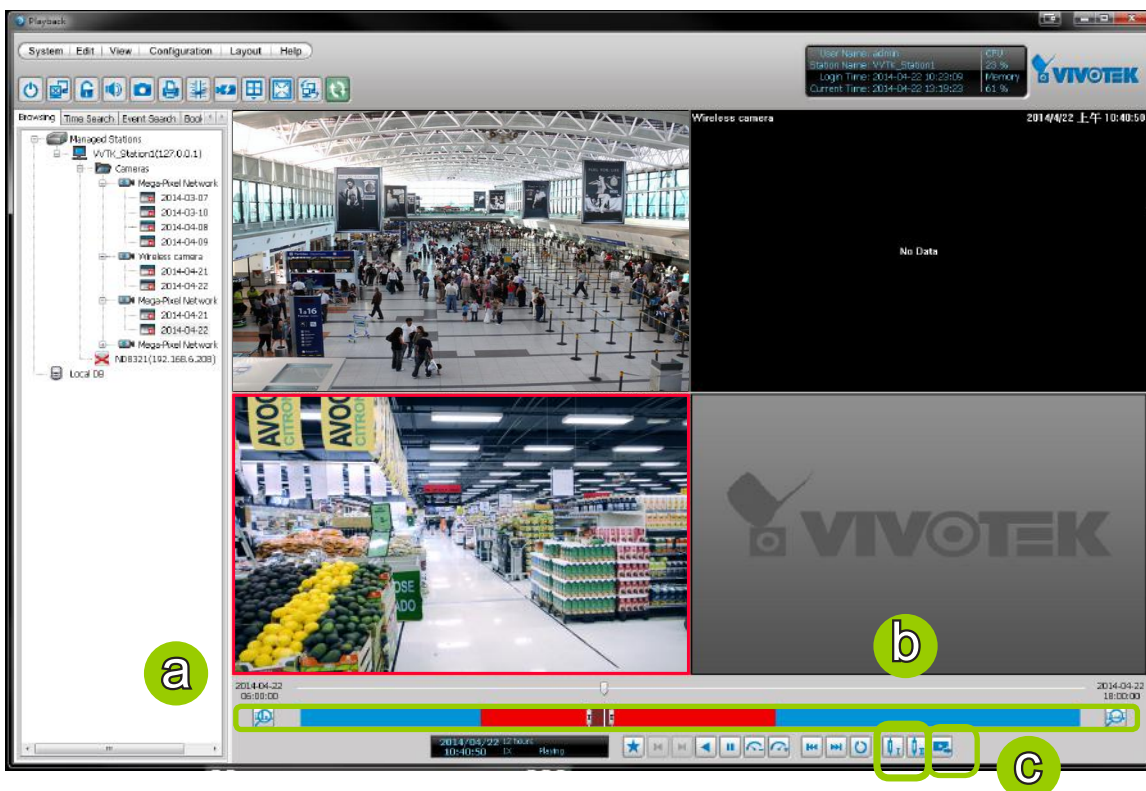

- c. Click Export EXE/3GP/AVI , the server will start to export the data and popup a window showing the exporting status. If you close the status window, you can also open it again by clicking **View > Exporting Status**.
- d. When the export is complete, you will see an information dialog. The exported data will be restored in the preset storage folder on your local computer (C:\ProgramData\Documents\VIVOTEK Inc\VAST\Client\PlayBack\Export).

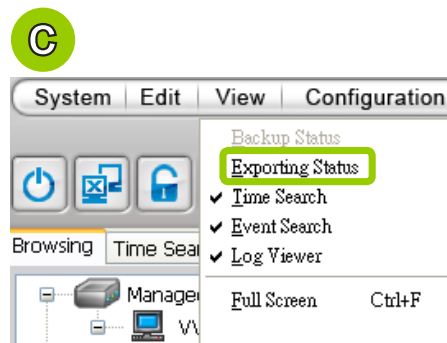
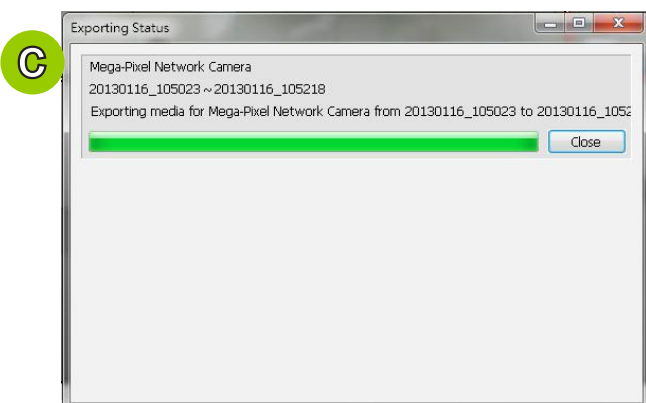

## View Settings

This section allows you to set up the display mode of video cell. For detailed information about **View Settings**, please refer to page 187.

## Proxy Settings

Please refer to page 205 for detailed illustration.

## General Settings

### System Settings

Please refer to page 190 for detailed information.

### Display Settings

- Enable de-interlace function: Select this option if your connected device does not support de-interlace function. For example: VS7100.

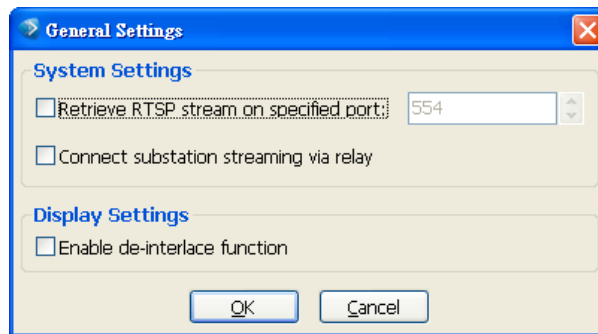

## How to Configure Video Enhancement

The Playback also allows you to enable post-image enhancement and defog for video viewing. Please refer to page 209 for detailed information.

## How to Search for a Device on the Hierarchical Management Tree





The Playback also allows you to conveniently search for an inserted device. Please refer to page 214 for detailed information.

## How to Print a Video Image

The Playback also allows you print out an image of live video. Please refer to page 215 for detailed information.

## How to Lock VAST Playback for Security Concerns

If you happen to be away from your computer, for security reasons, we suggest you lock the program. When VAST Playback is locked, the user must enter the correct password to unlock and access the program again.

- To lock Playback, click **Unlock**  on the quick access bar or click **System > Lock** on the system menu. The **Unlock**  icon will then turn into **Lock** .
- To unlock Playback, click  and enter the correct password in the popup window.

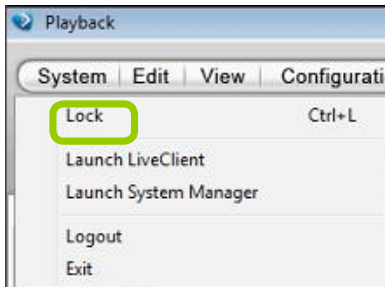

## How to Log out from the VAST Server

To log out from the current server, click the station and click **Logout**  on the quick access bar or click **System > Logout** on the menu bar. You can also **right-click** the station and click **Logout**. A confirmation window will pop up. Click **OK** to confirm or **Cancel** to return to the VAST Playback window.

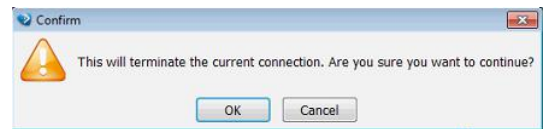
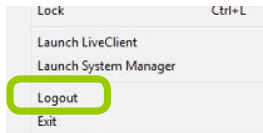

## How to Exit VAST Playback

To exit VAST Playback, click **Exit**  on the quick access bar or click **System > Exit** on the menu bar. A confirmation window will pop up. Click **OK** to confirm or **Cancel** to return to the VAST Playback window. When you exit the program, your user account will be automatically logged out from the current server.

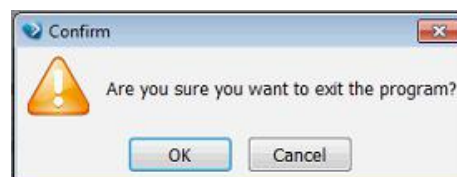
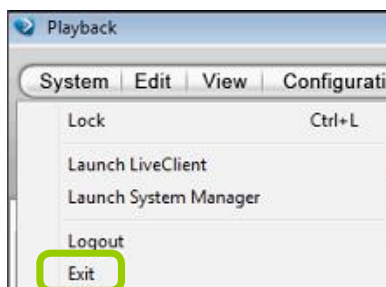

# Import and Export Utility

VAST supports import and export utility for user to keep record of all server settings. You can use the export file to copy the configuration on another host.

## Export Utility

Please follow the steps below to export the server settings:

- a. Under Microsoft Windows, choose "**Start > All Programs > VIVOTEK Inc > VAST > Tools > Import-export Utility.**"



- b. The **Import/Export Utility** window will pop up. Click **Export** and select a target folder. The system will start to export a .bin file.

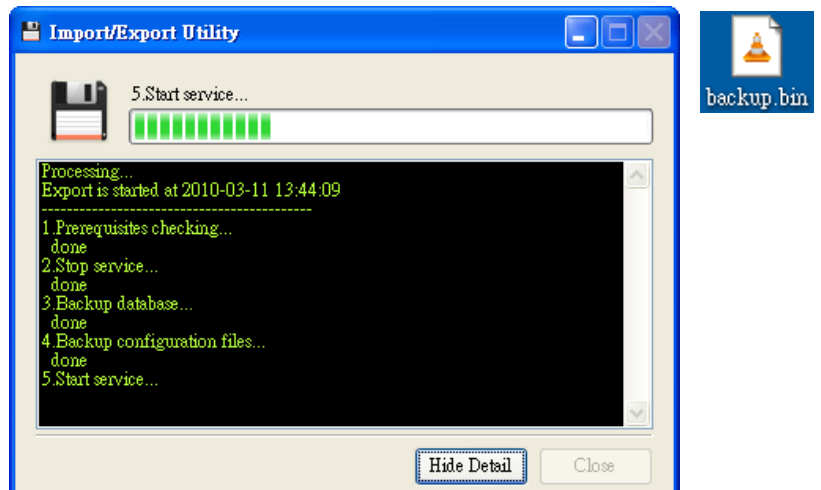
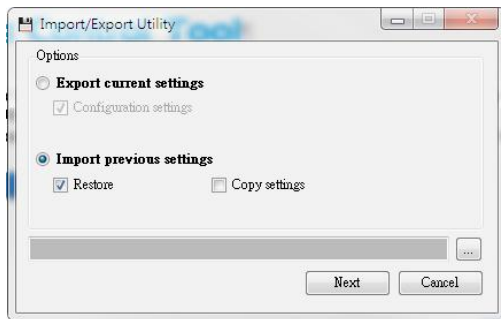

## Import Utility

Please follow the steps below to import the server settings:

- a. Under Microsoft Windows, choose "**Start > All Programs > VIVOTEK Inc > VAST > Tools > Import-export Utility.**"
- b. The **Import/Export Utility** window will pop up. Click **Import** and select the export file. The system will start to import the file.

You should then select the **Restore** or **Copy** settings options.

**Restore:** If this is selected, the VAST server GUID will also be restored. This option applies when you need to restore as crashed server.

**Copy Settings:** This applies you use the exported profile to duplicate your configuration to multiple computers. A new server GUID will be generated.



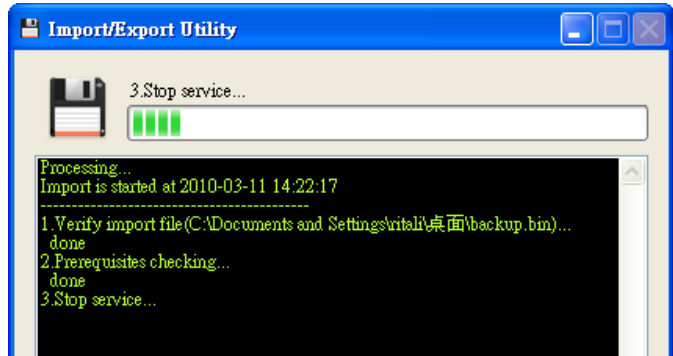
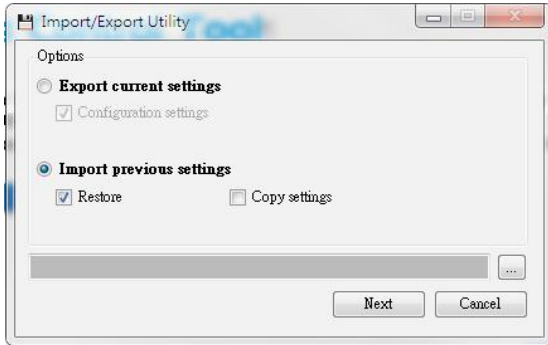
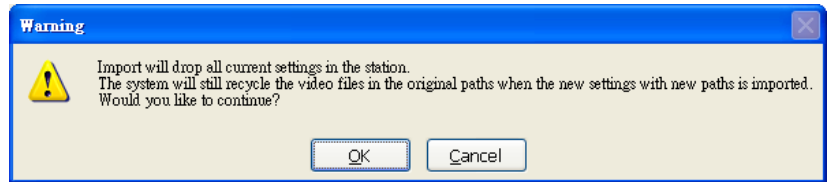



# VAST Service Control Tool

VAST service control tool is a tool for server control and for user to be aware of the VAST Server status. It starts up as Windows OS startup.

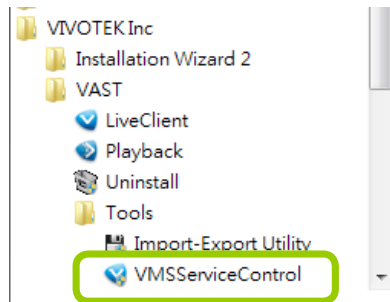
Under Microsoft Windows, choose "**Start > All Programs > VIVOTEK Inc > VAST > Tools > VMServiceControl.**"



You may also find it in the system tray icon of the tool bar, which indicates that the service is running: 

It shows a disconnection icon when the service is stopped: 

A menu for the service control tool will pop up when you **right-click** on the icon:

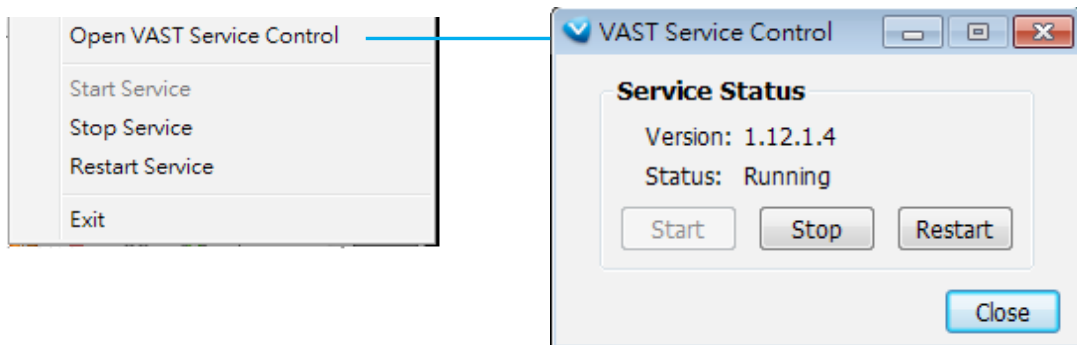

Here you can manually start, stop and restart the service.

## Appendix A Failover Server Configuration

VAST servers can be configured into two groups: Active and Redundant. The Active group performs daily recording and monitoring tasks, while the Redundant group acts as the standby servers. In the event of server failures, the Redundant group becomes active, and takes over the recording task.

The Redundant server group configuration consists of the following:

1. One VAST server designated as the **CMS** (Central Management server) VAST central management server.
2. At least one VAST server in the **Active** group.
3. At least one VAST server in the **Redundant** group.
4. Gb/s network or higher-speed connection among the servers. All Active and Redundant groups can reside in different subnets, provided that static IPs are configured for these servers.

### IMPORTANT:

For a Redundant server configuration, you must first enlist VAST servers in the **Sites** configuration page before configuring the Redundant server groups. See the **Sites** configuration page.

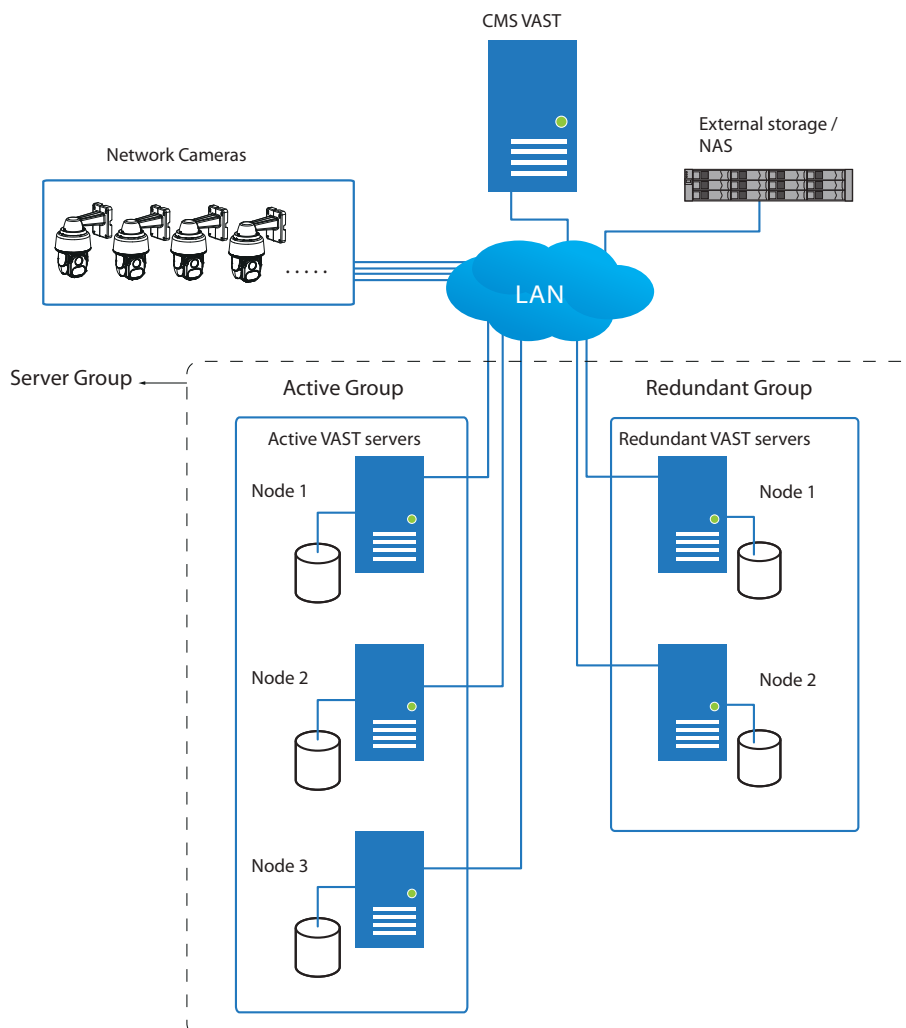

Below are the definitions of server roles:

1. **CMS** VAST server: The main access portal for the configuration.

1-1.	CMS server is where the <b>Failover</b> configuration takes place.
1-2.	CMS continuously polls to check the hearbeats to monitor the statuses of all Active and Redundant servers.
1-3.	CMS regularly backs up the configurations on Active servers.
1-4.	CMS assigns redundant server(s) to the takeover of a failed Active server.
1-5.	In a Redundant server configuration, the CMS is supposed to be up and running at all time. If the CMS server fails, the server failover and failback operation will not take place. It is therefore preferable to install the CMS server at a high up-time environment, such as on a VMWare configuration.

2. **Active** servers: Active VAST servers are the work horses that perform recording and monitoring tasks.

3. **Redundant** servers: The Redundant servers are actually active-standbys. They participate to continue video recording in the event of active server failures. It is recommended for the Redundant server to have an equivalent or higher processing power than the Active servers. The same applies for the storage volume and write performance.

Note that you cannot configure a Redundant server by opening a local console.

The conditions during the failover are illustrated below:

Multiple Active and Redundant groups can be created.

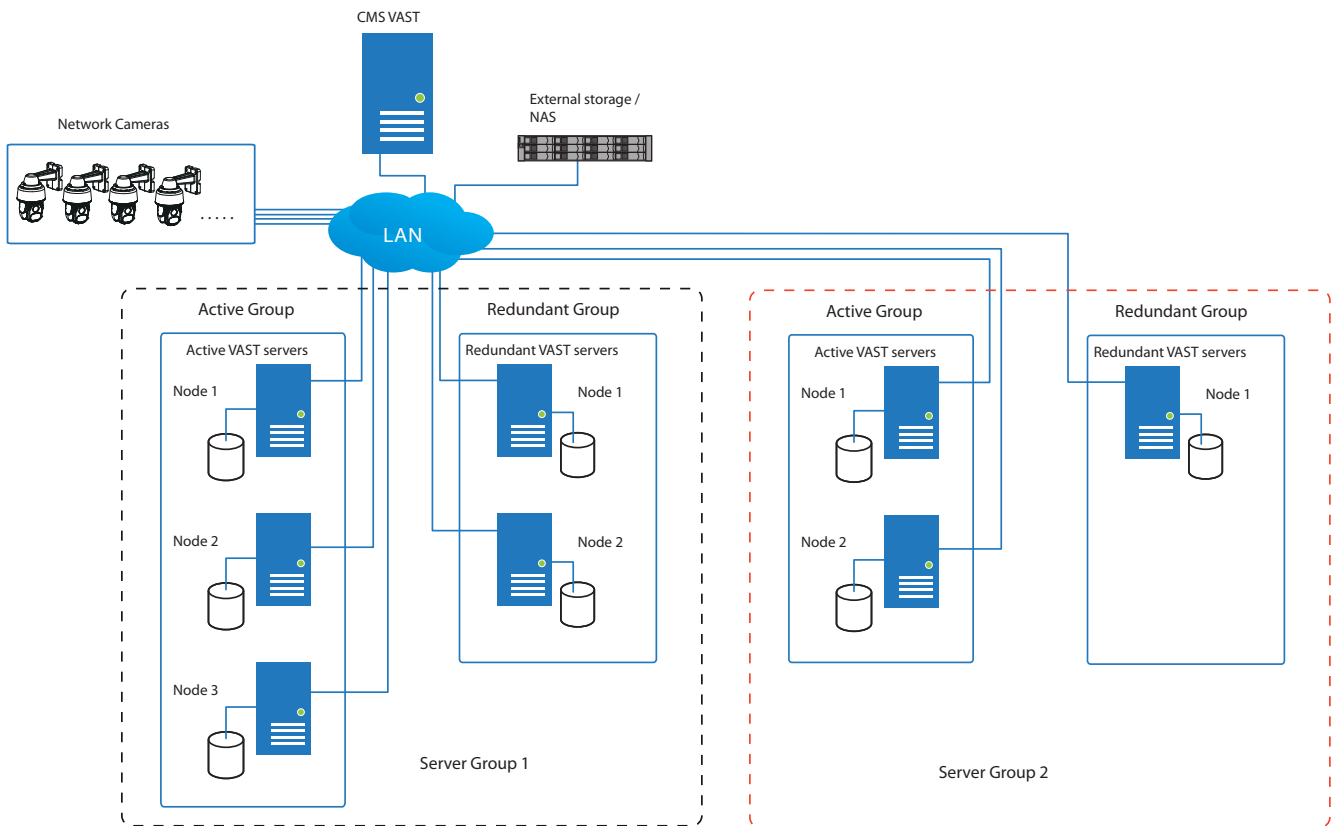

Each Redundant server can serve as the backup for ONE Active server. Depending on the number of the Active and Redundant servers, if the number of failed servers exceeds the number of Redundant servers, the failover will be abandoned. For example, if 2 Active servers failed, and there is only 1 Redundant server available, the second Active server that failed will be abandoned.

In the event of a server failover, a VAST server in the Redundant group takes over the recording task. Note that depending on the network environment, the takeover can take up to 5 minutes.

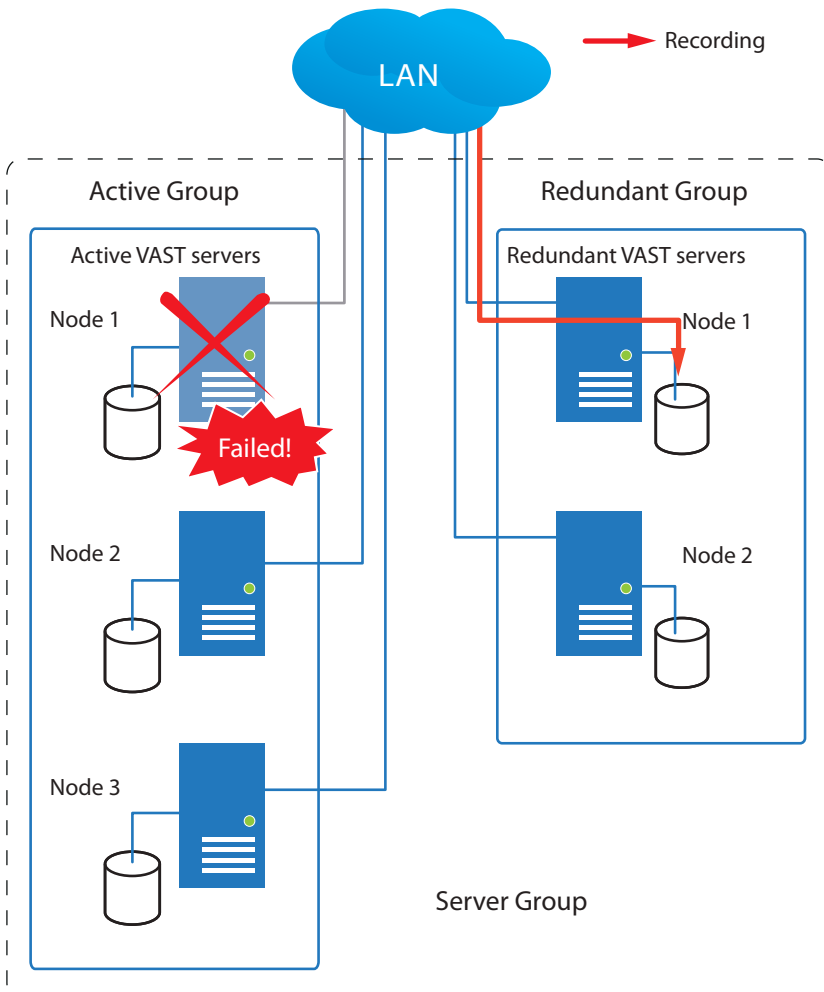

Once the server in the Active group is restored to normal operation, and a CMS server requests for the recordings and data occurred during the time the active server failed, the requests will be fulfilled by a shared volume on the redundant server. Due to the concerns with network bandwidth and processing power, the restored active server does not synchronize its recording pool with that on the redundant server.

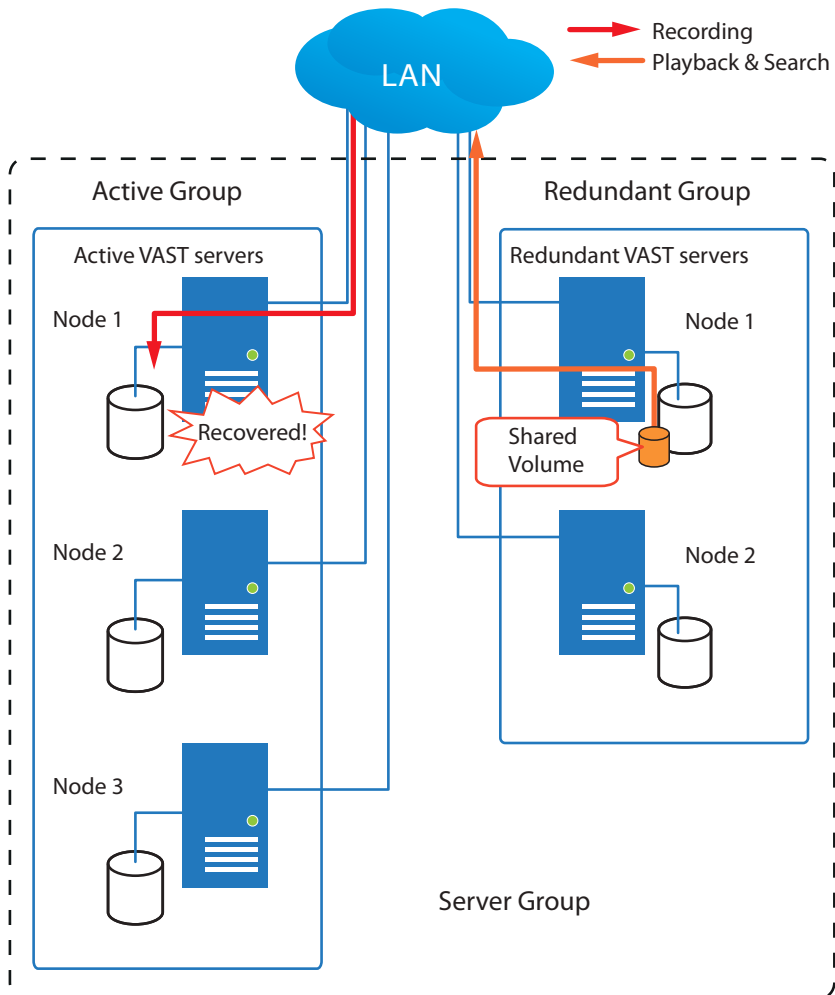

The recovery path should be available in the network neighborhood, with a name that looks like the following: ActiveServer1\_91AAF3D06B6C47\_\RecGroup1.

If an Active server has 3 recording groups, then each Redundant server will have 3 recording paths accordingly.

In terms of network failure, the VAST2 configuration supports Seamless Recording. For cameras equipped with an SD card, video is recorded to the SD cards in the event of network failure. Of course, the camera must be powered by a secondary power source, such as a DC 12V input. In cases such as the only PoE switch or PoE mid-span fails, power is lost.

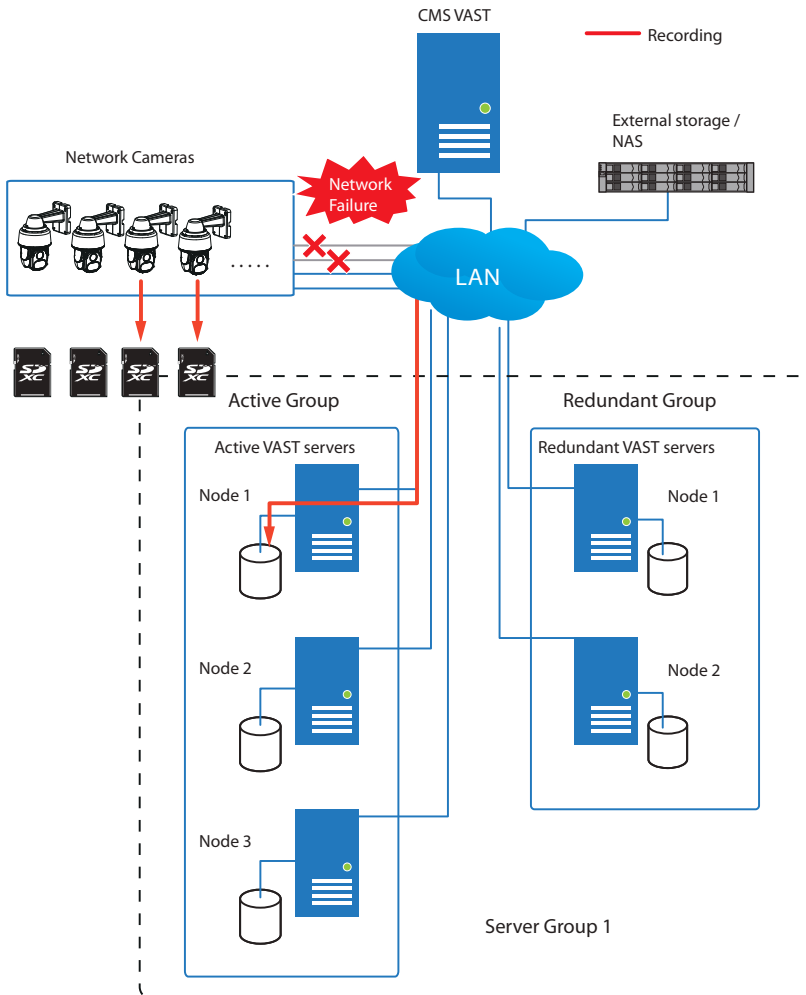



Once the network connection is restored, the VAST2 servers resume the recording task and also retrieve video segments from the SD cards. The video segments recorded during the network failure will be stitched up with those occurred before and after the network failure. The retrieval speed varies depending on the available network bandwidth and CPU resources.

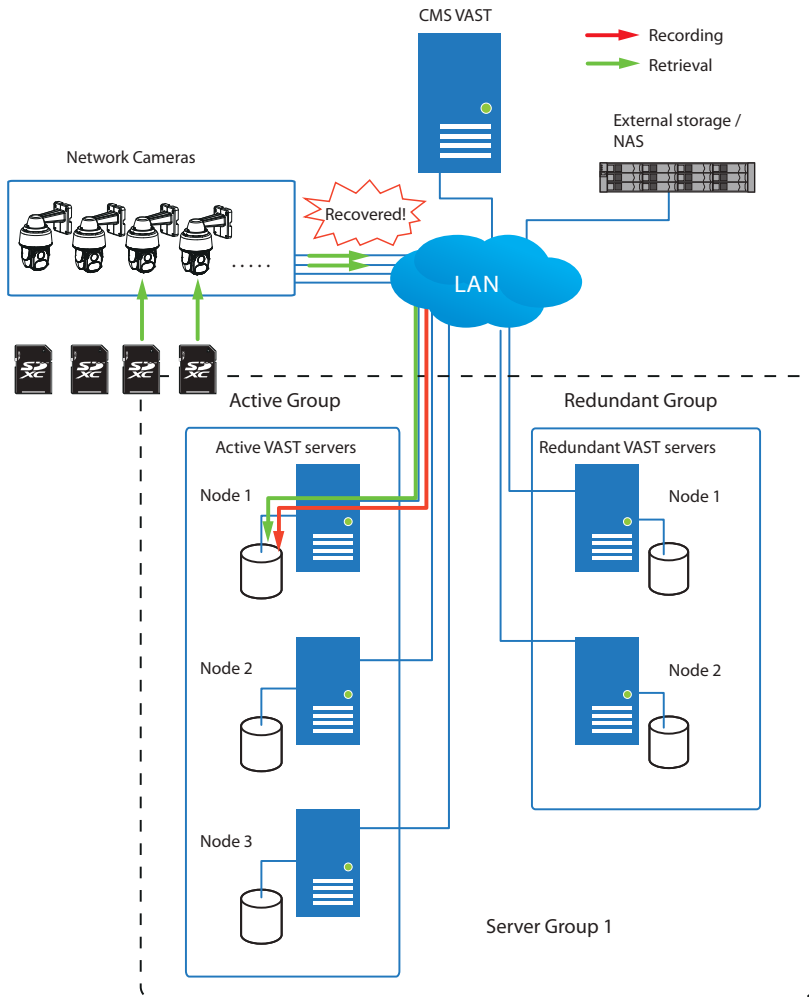

To enable Seamless recording, find the associated option in **Configuration > Camera Management > Camera Update**, and select the Seamless recording checkboxes. Camera models that support the Seamless recording option will have it listed.

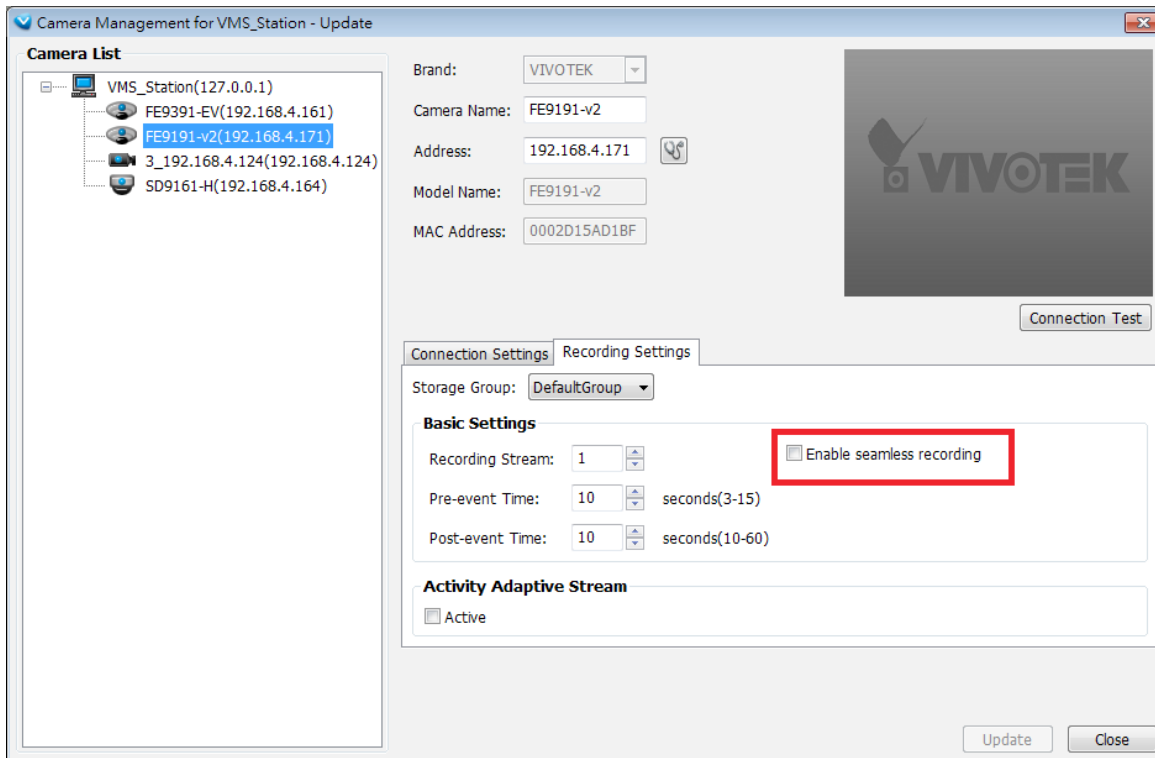

## Failover Configuration Process

Before Failover configuration, you need to add other servers to your Failover configuration.

- If you are adding a Redundant server, enter the "**Redundant Server Management**" screen.
- When adding a Redundant server, you can provide a Windows account 802.1x domain user name and password. A Redundant server requires this because a full access to the recorded data is required during the failover and failback process.

To configure Redundant servers,

1. Install VAST server on a server chosen as the active standby.
2. On the server chosen as the VAST CMS server, open **Configuration > Failover Management > Redundant Server Management**.

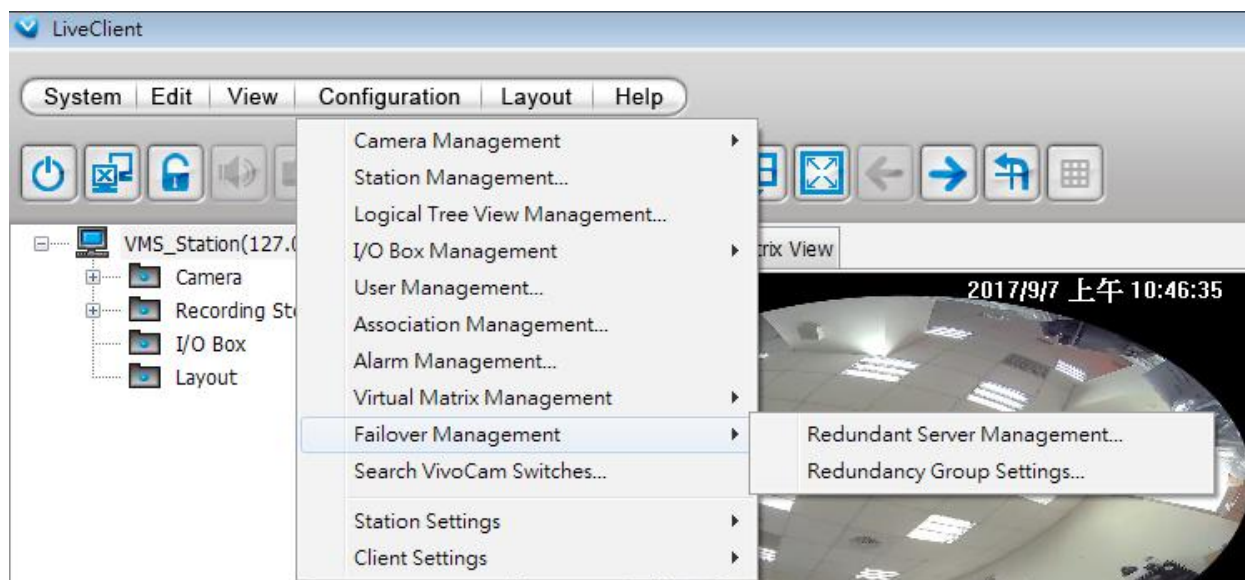

Note that it is a must for the Redundant server to be installed differently by selecting a "**Redundant server**" checkbox during the installation process.



3. Enter the IP address and Windows AD credentials for access to the Redundant server. Click the Add button when done, and click the Done button to leave this page.

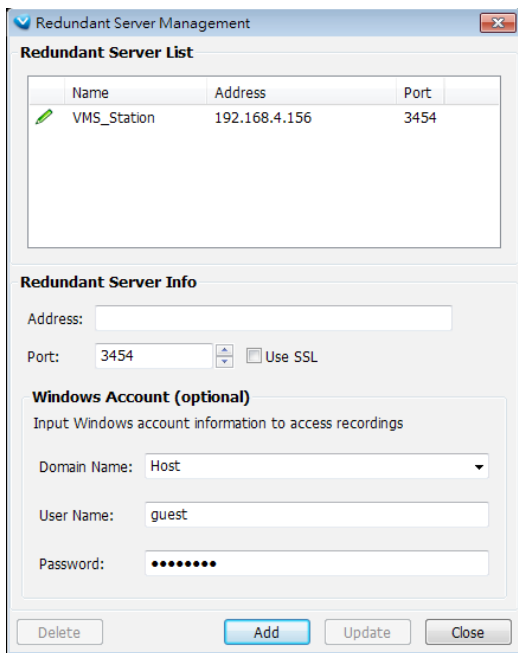

An Active server must have a CMS password configured for the hierarchical configuration.

Note that on the Active servers, you should configure them as the subordinates to your CMS VAST server. On a web console with these servers, open the Site management page, and select **"Allow CMS connection."** Create a common password for the CMS hierarchy.

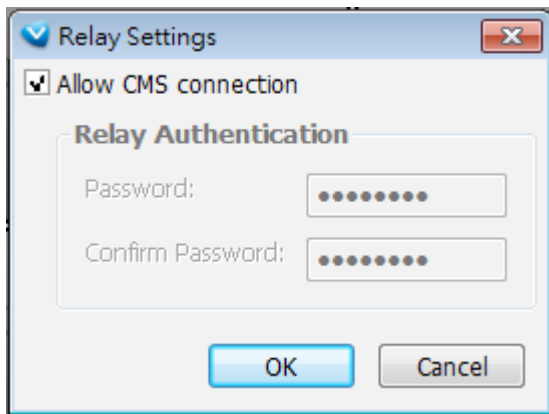

Two agents will be running on the Active and Redundant servers, "stunnel" and "VMSWebServer." Make sure they are not blocked out by your firewall. These agents can be found in the default folders below:

C:\Program Files (x86)\VIVOTEK Inc\stunnel\stunnel.exe

C:\Program Files (x86)\VIVOTEK Inc\VAST\Server\VMSWebServer.exe

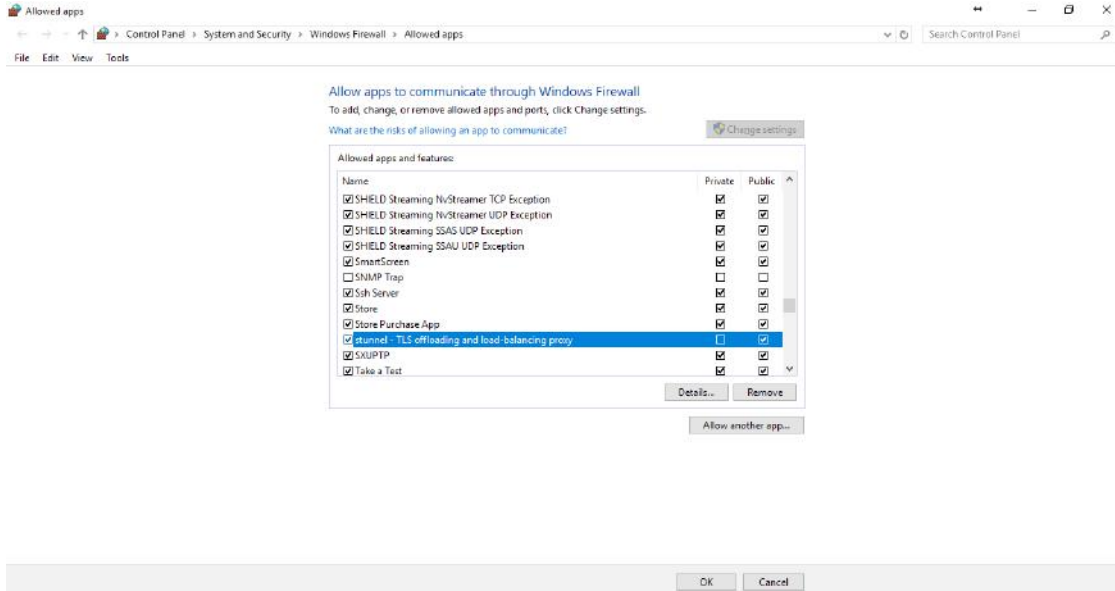

4. Enter **Configuration > Failover Management > Redundant Group Settings**. Enter the Group name, Description, and click on the Edit button .

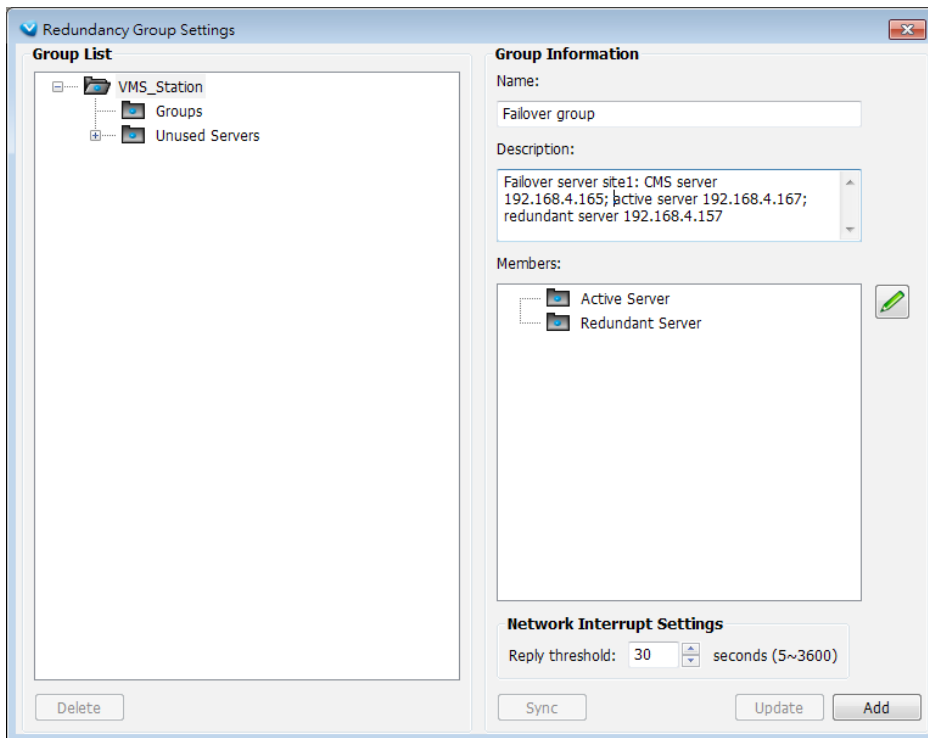

5. Select the Active and Redundant servers and move them to the list of Selected servers. The Active and Redundant servers you enlisted should all be listed below. Select the members of the Redundant group, and click OK to complete.

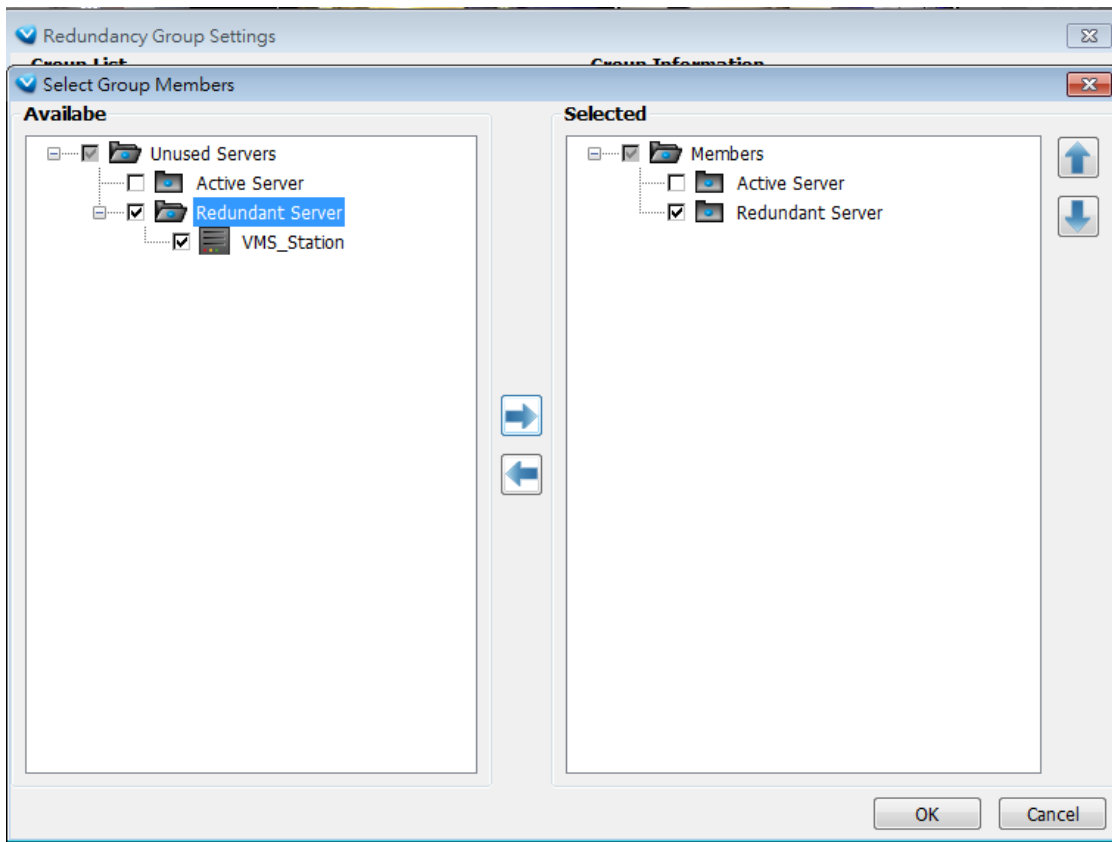

The default for the network disconnection timeout is 30 seconds. It is not recommended to configure a very short timeout, e.g., 5 seconds, because if doing so, a temporary network disorder can make servers consider the Active server(s) have failed.

Using the failover function requires Failover license. On the CMS server, you can check the number of channels in Help > Failover license. Below are the requirements for running a failover configuration:

1. In a Redundant server group, the number of licensed channels = No. of Active server channels x No. of Redundant server(s).

For example,

There are 3 Activer servers with 100, 125, and 165 channels.

There are 2 Redundant server.

The number of failover license channels are:  $165 \times 2 = 330$ .

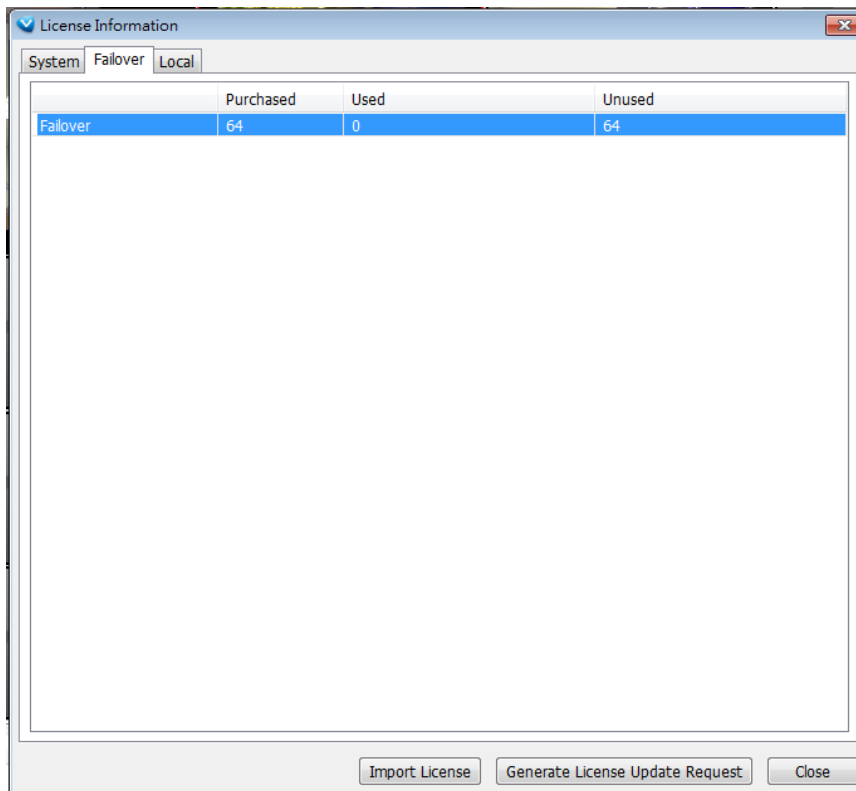

2. Error prompts will display if there are not sufficient failover channels when you create a Redundant server group.



# Appendix B Panoramic PTZ (P-PTZ) Configuration

## Enable Panoramic PTZ on VAST

The process of configuring two cameras (1 fisheye and 1 speed dome) into the Panoramic PTZ configuration takes place on a PC using the calibration tool. The Auto Tracking feature is configured using a web console with the fisheye camera. A Panoramic PTZ package should comprise two cameras running specific firmware for this application and a software CD containing all necessary utilities. For configuration details, please refer to the **Panoramic PTZ Installation Guide**.

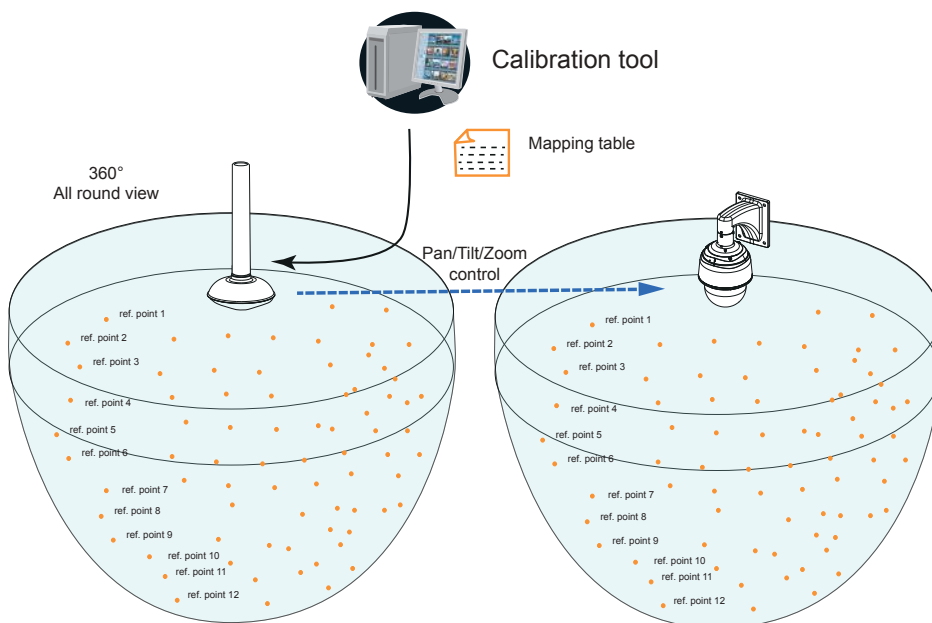

To exert Panoramic PTZ control on VAST:

1. Once these two cameras are configured into an interactive pair, insert these cameras into your VAST configuration.
2. Select a preferred layout using the Layout  button. The 1P+2, 1P+6, and 1P+8 layouts are specifically designed for the Panoramic PTZ configuration.
3. Taking the 1P+2 layout as an example, once they are listed on the device list, click and drag the fisheye camera to the upper left and the bottom view cells. Place the speed dome in the upper right view cell.

Fisheye 10	Speed Dome
Fisheye 1P	



4. Right-click on the fisheye's view cell to change its Display mode either into the **1O** (Original) or the **1P** (Panoramic) mode. Note that the Panoramic PTZ control does not take effects on the "R" (Regional) mode and the combinations of other display modes.
5. There are two different ways to quickly exert Panoramic PTZ control. The pan, tilt, and zoom actions are made from the fisheye's 360° hemispheric overview:
  - 5-1. Click on a spot on the fisheye's Original or Panoramic view where you detected a condition of your interest. The speed dome will aim its lens at the corresponding position to cover that field of view.
  - 5-2. Click and drag a region of interest either on the Original or on the Panoramic view. The speed dome will move to that region and zoom in to fill the same proportion of view into its view cell.
    - On the Original view, click-and-drag creates a circular region of interest.
    - On the Panoramic view, a square region.
    - If you draw a small region, the speed dome will zoom in on the scene. The smaller the region, the larger the zoom-in ratio. A large region makes the speed dome to zoom out.

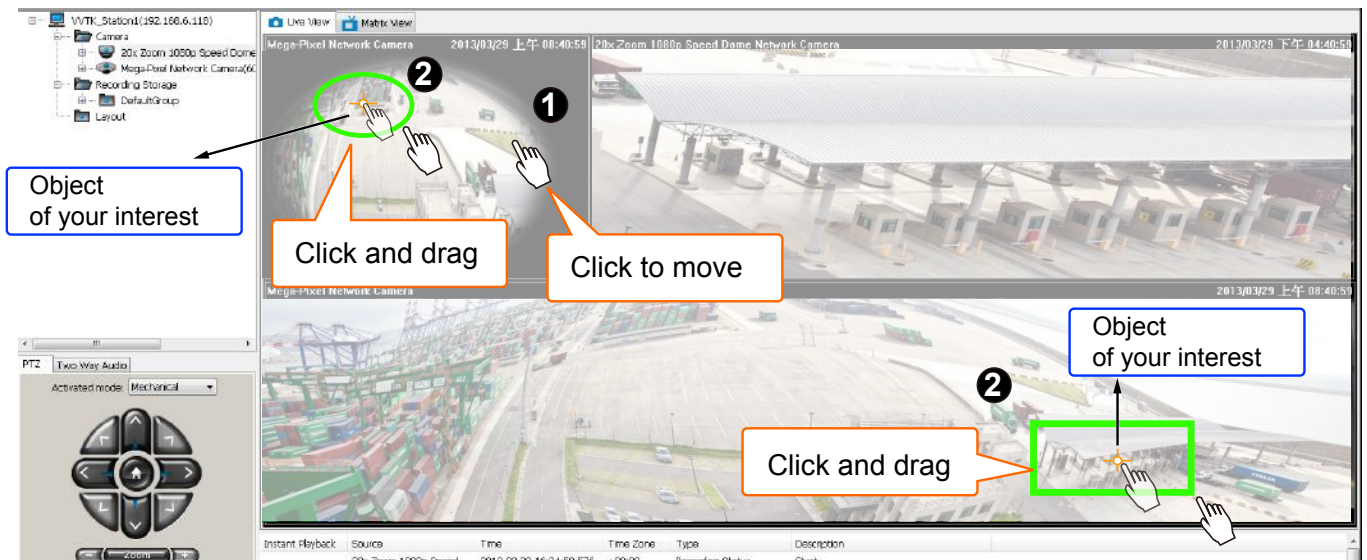

The speed dome camera automatically performs optical zoom in/out to best fit the selected field of view until the maximum and minimum zoom ratio is reached.

**Tips:**

1. When drawing a region of interest, click and drag from the center of your interest over a diagonal line to the bottom right. It is not like drawing a diagonal line from corner to corner.
2. To swipe the Panoramic view left or right, press and hold down the **Ctrl.** key and the left mouse button.

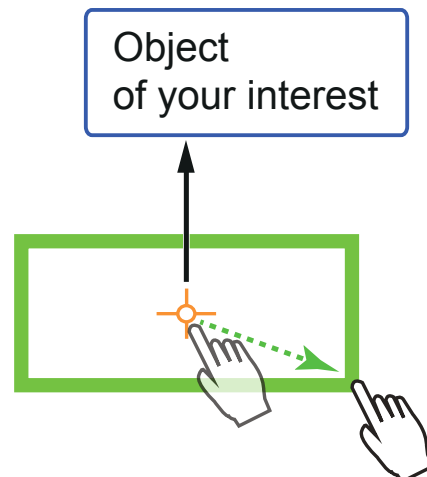



1. The fisheye and the speed dome are made into an interactive pair using the calibration tool. The VAST software provides the control interface only. If the cameras have not been properly configured, the Panoramic PTZ function will not take effect.
2. If the password of the speed dome camera has been changed, you will need to open a web console with the fisheye camera to change the coordinate password.
3. You may need to reset the fisheye camera if the speed dome camera is powered on after you started the VAST software.
4. The precision level of the interactive positions between the view cells of the fisheye and the speed dome is determined by the mapping table. Make sure you have inserted a sufficient number of reference points and make good association of these points using the calibration tool.
5. Currently the associated event trigger by Auto Tracking is not supported on VAST. The associated event triggering is configured through a web console with the fisheye camera:

**Applications > Panoramic PTZ**

General settings | Import/Export files

Enable Panoramic PTZ

Enable Auto tracking

**Auxiliary camera information**

IP address:

HTTP port:

Controller camera account

User name:

Password:

Associate the auto tracking event with the auxiliary camera's manual trigger  1  2  3

- 5-1. You should then create an event setting using the manual triggers as triggering sources.
- 5-2. When Auto Tracking takes place, the pre-configured event settings on the speed dome camera can take associated actions, e.g., taking a snapshot, recording to SD, or triggering the DO pins.
6. The Panoramic PTZ function is currently not available on the Matrix or web console mode in VAST.
7. If the interactive camera pairs (Panoramic PTZ cameras) are managed under VAST substations, then all of the VAST instances, such as the primary VAST server, the substations, and the client side must be running the revision that supports P-PTZ.

## Panoramic PTZ - Event Trigger

The P-PTZ-related event types include: "triggered" and "returned to normal" when Auto Tracking takes place. Below are the configurable options with the event configuration:

1. When configuring a recording schedule, the Auto Tracking actions can be selected as one of the event triggers. The configuration is found in **Configuration > Station Settings > Recording Schedule Settings**.

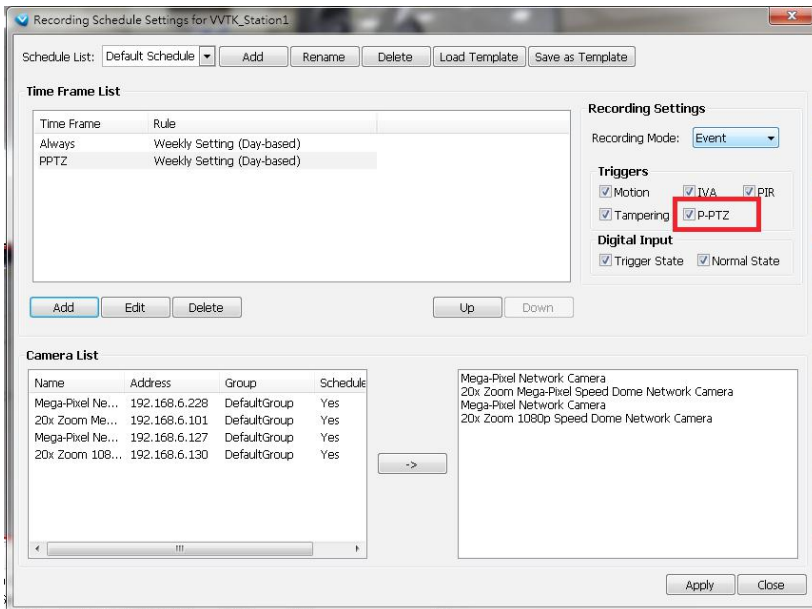

2. When Auto Tracking is enabled, its actions are considered as one of the system event types. In **Configuration > Event Management**, P-PTZ is configurable as a Trigger Type in **Event Management > New Event > Trigger**. This event trigger can be associated with different actions, such as Email, recording, moving to a preset location, GSM message, HTTP, Client notification, etc.

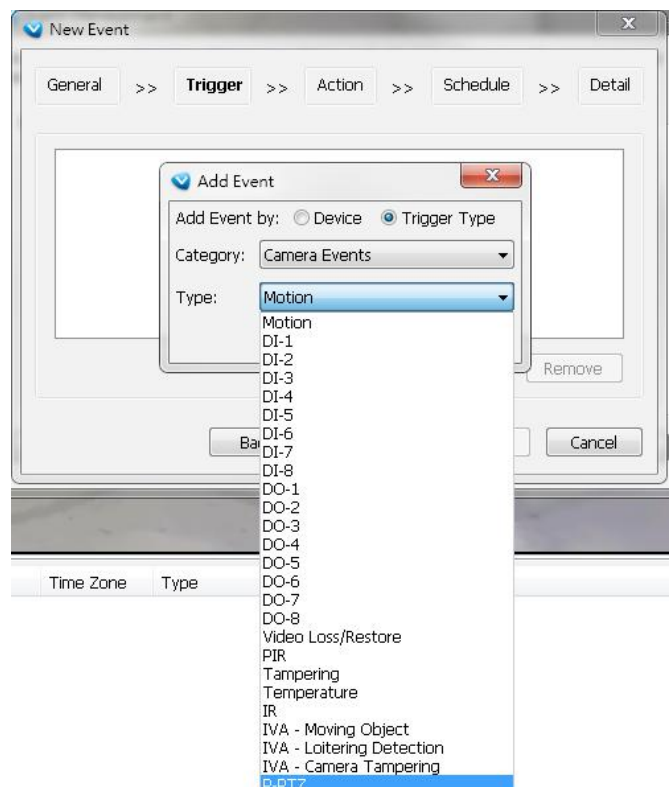
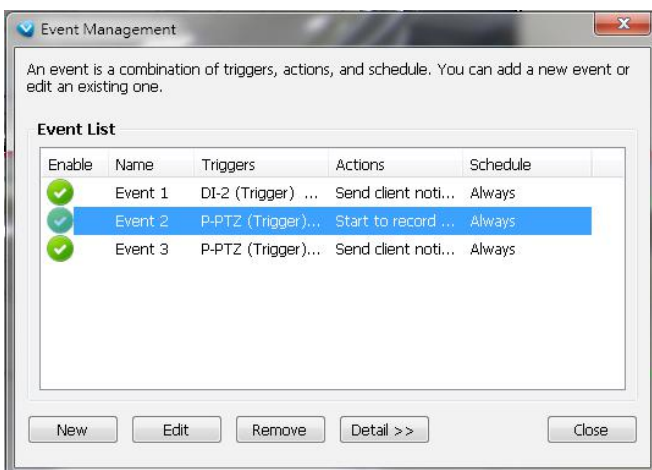

Auto Tracking can also function as a Device type in the Event Management configuration.

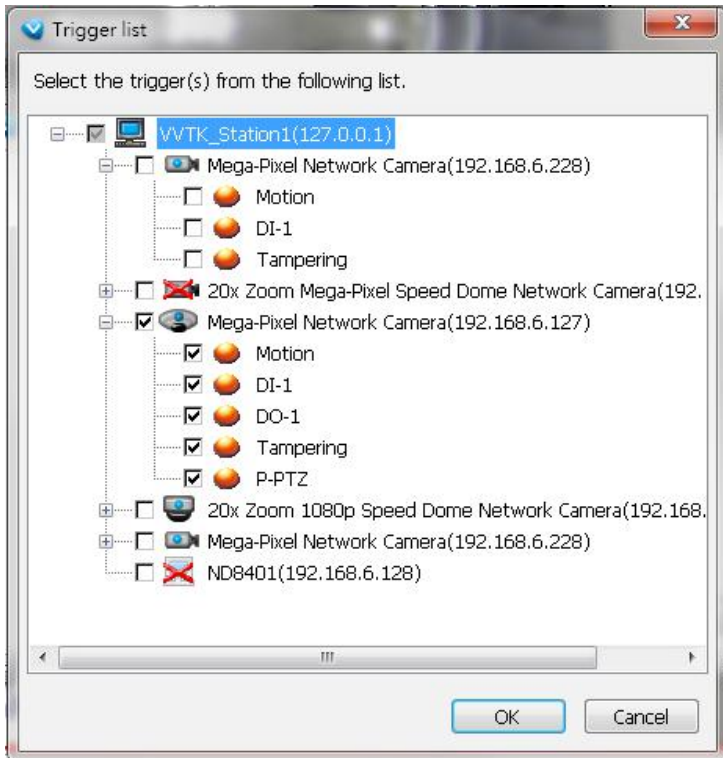

Once triggered, the P-PTZ Trigger and P-PTZ Normal events will create two short videos for a length of 30 seconds.

Note that the P-PTZ event is not triggered by Panoramic PTZ control on the view cells, it is triggered by Auto Tracking. Auto Tracking takes place when a moving object enters the pre-configured region of interest. Please refer to the **Panoramic PTZ Installation Guide**.

3. Events triggered by Auto Tracking are also recorded into system logs.



4. As the result, in **Playback > Event Search** panel, Auto Tracking (P-PTZ Trigger/Normal) is also a search condition.

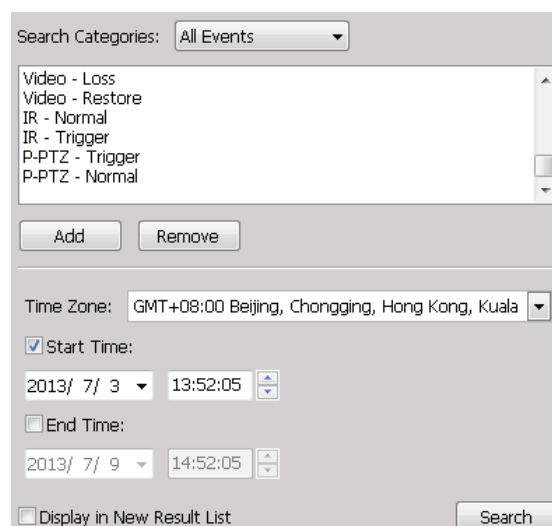

## Enable or Disable the Panoramic PTZ Functions

You can manually enable or disable the Panoramic PTZ function in **Configuration > Camera Management > Camera Configuration**:

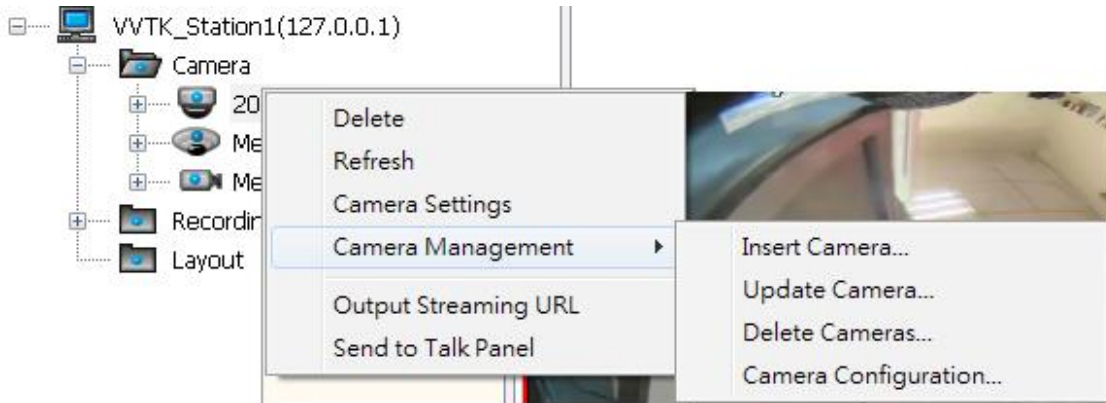

1. Select the fisheye camera by a single click, and then open the panoramic PTZ panel from the tabbed menu.
2. You can enable or disable the panoramic PTZ or the Auto Tracking functionality using the checkboxes.
3. Click the Save button, and the saving progress window will prompt.

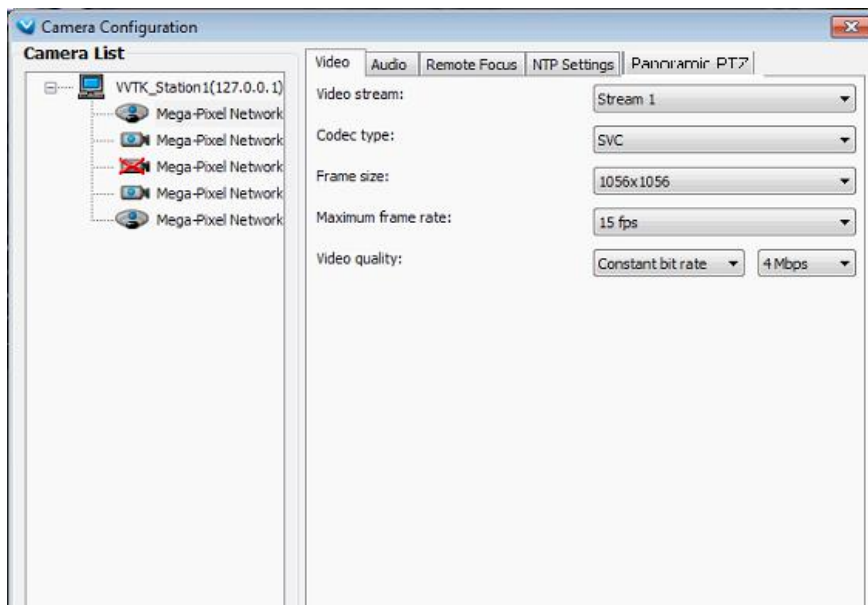

4. Click Close to end the configuration process.

## Appendix C ONVIF Support

ONVIF is supported in an environment where the VAST server can detect and record video streams from the cameras made by other manufacturers.

The following are supported.

1. ONVIF camera icons on the device tree. 

Brand name selection is also available on the configuration window.

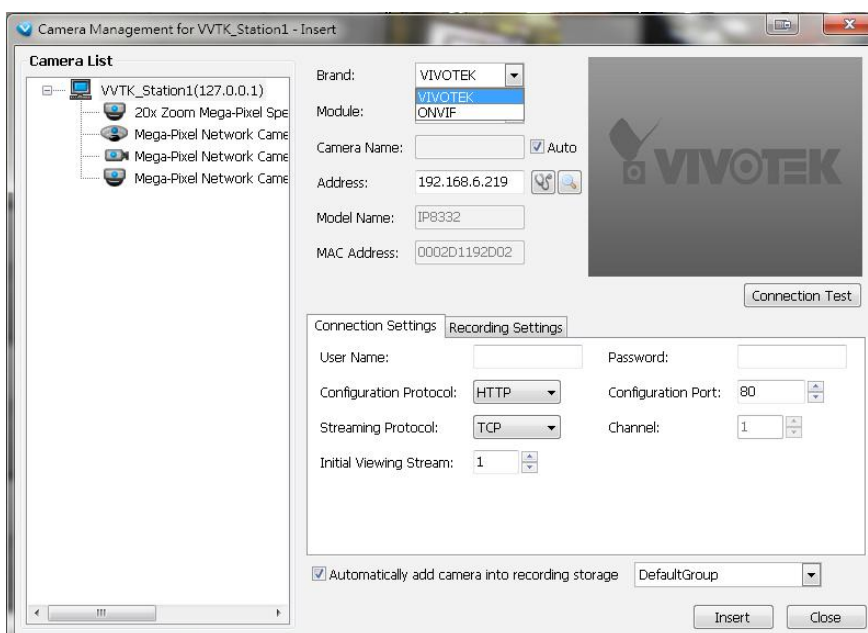

2. Insert/update/delete camera from the device tree.

- 2-1. Detect ONVIF cameras.

- 2-2. Connection test.

- 2-3. camera password authentication.

- 2-4. Supports HTTP and HTTPS streaming protocol.

- 2-5. Supports multiple streaming.

3. Live view/recording/playback.

- 3-1. Audio G.711 support.

4. Mechanical PTZ support with the exception of Focus, Iris, Pan, Patrol, and preset location operation.

## Limitations:

The following limitations apply to ONVIF cameras made by other manufacturers. Some features may be implemented in later releases of software.

1. Users should ensure that your other brand cameras support ONVIF.
2. The connection statuses of the other brand cameras will not be displayed on the device tree.
3. For mechanical PTZ cameras, the Focus, Iris, Pan, Patrol, and preset locations functions will not be supported. The associated buttons and control elements on the UI screen will not be disabled.
4. Does not support the Batch Insert Camera function.
5. Does not support Camera Configuration.
6. Does not support Active Adaptive Stream (AAS) function.
7. Does not support Event related functions, including event recording, event management, instant playback, event search, etc.
8. Does not support camera DI/DO.
9. Does not support Two Way Audio.
10. Does not support Auto Stream Size.
11. The ONVIF user authentication (account and password) may not comply with those configured via a web console.
12. The number of multiple profiles can vary.
13. The number of accessible profile can vary. Some might have only one profile to be connected.
14. Does not support Click on Image.

## Appendix D VCA Report

The VCA Report utility is started from **System** menu > **Launch VCA Report**. The VCA Report utility provides comprehensive graphs and line charts for quick access to the data collected through VIVOTEK's People Counting modules, such as the SC8131 stereo camera. Statistical results is refreshed by hour or minutes, and you can compare the results acquired through different time periods or among different surveillance areas. These data help figuring the customer flow in retails so that shop owners can optimize the arrangement of store layout, or manage queues more efficiently.

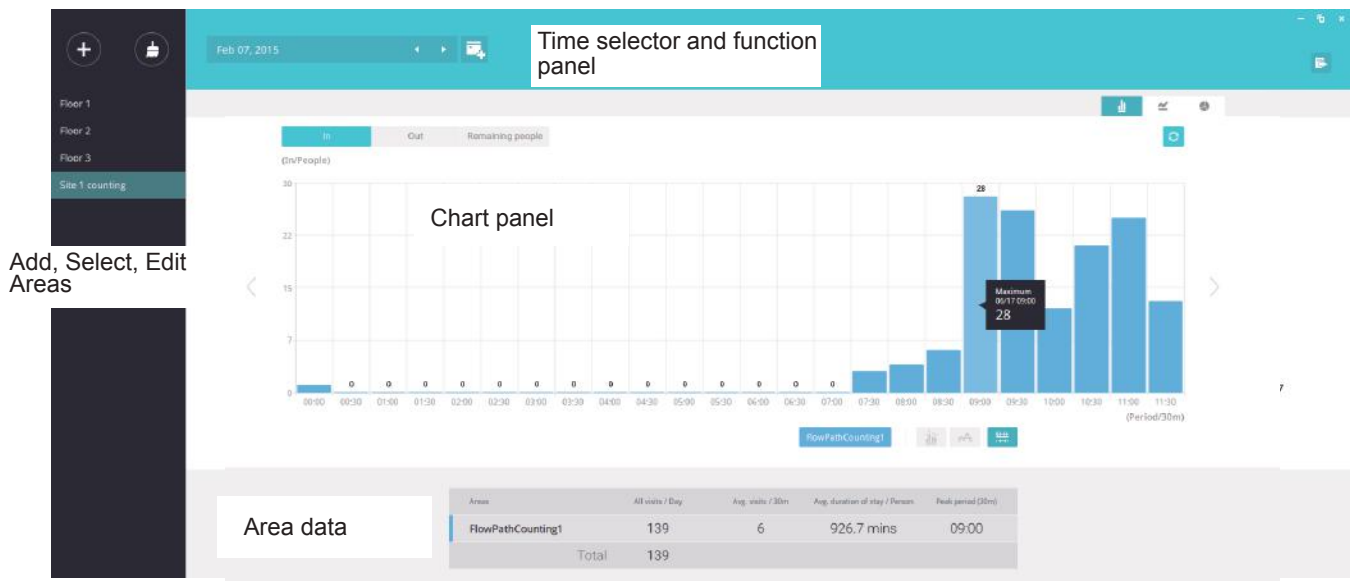

The configuration of detection methods in People Counting still occur on a web console with individual cameras. It is not configurable through the VAST LiveClient.

### Prerequisites:

The prerequisites for using the VCA Report are:

1. Cameras running the VCA utilities have been configured and added into the VAST deployment. The instances of available VCA rules will be listed in the **Area** panel.
2. The life expectancy of VCA records is 5 years.
3. Currently the utility supports Windows XP, 7, and 8.
4. The latest revision v.1.12 supports Seamless Recording, in order to retrieve collected data and recording during Ethernet disconnection. Provided that an SD card is installed on the SC8131 camera, the VAST station gradually retrieves data from the SD card after the connection is restored.



To begin using the VCA report:

### Create Areas

1. Click on the **Add**  button in the **Area** panel. Cameras running the VCA utilities will be listed. Click to select cameras. Those running multiple detection rules will be displayed on screen. Data collected for these rules is kept in camera's flash memory.
2. Click to select one or more cameras.
3. Enter a name for the area, and then click the **Create** button.
4. The Areas thus added will be listed on the Area panel on the left side of the screen.

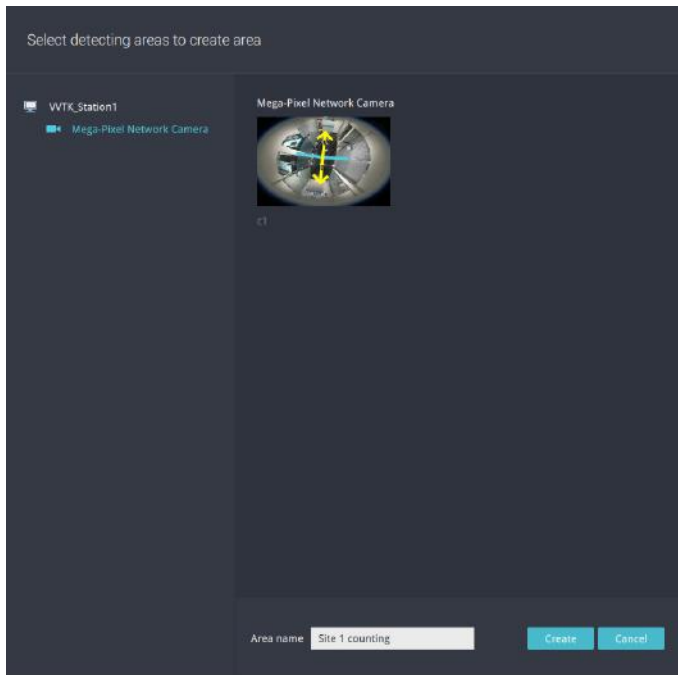

If you have multiple detection rules on cameras, you can manually remove some of them from the list by mouse-overing the rules. After you configured an area, you can still right-click on an area to configure its parameters.

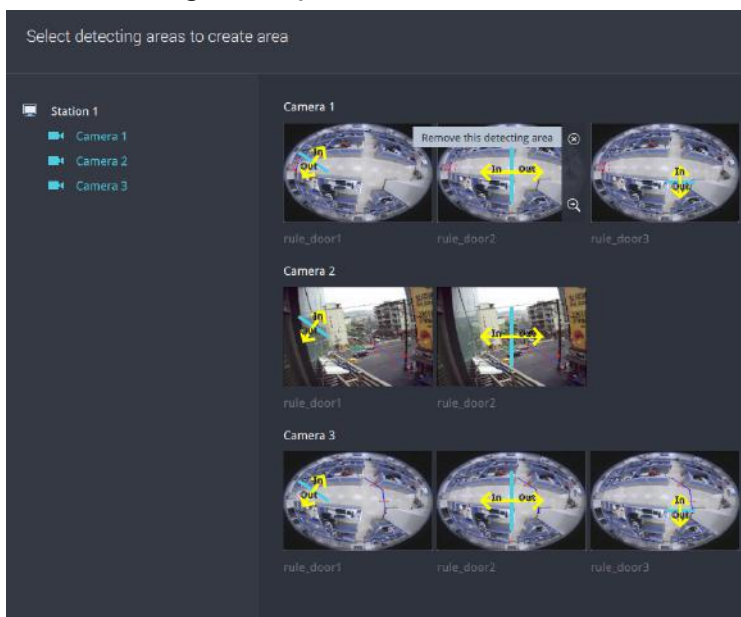

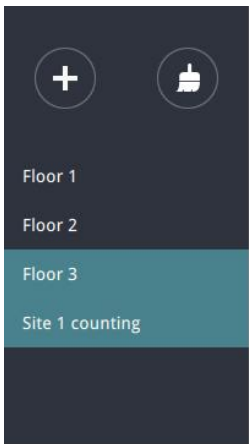

If only one camera is selected, its name will apply as the Area name. If not, enter a name for the area.

5. Click to select one or multiple areas. Those selected will be highlighted in a different color.



### Select Date & Time

6. By default, the time displayed on the calendar is the current system time on the client computer running the utility. Select from the **Date** selector  on top.

7. Select a date or span of time from the calendar or use the and **Time**  selector to select a span of time.

- > Single-click to select a date or click and drag to select multiple dates.
- > You can select a month or a year using a single click. If you select a month, the timeline unit will be days within the month. If you select a year, the timeline units will be the months in a year.
- > In the **Month** or **Year** panel, single click to select the entire month or an entire year. Double-click to select sub-units, e.g., days within a month. If you double-click on a Month panel, you will enter the Day panel.

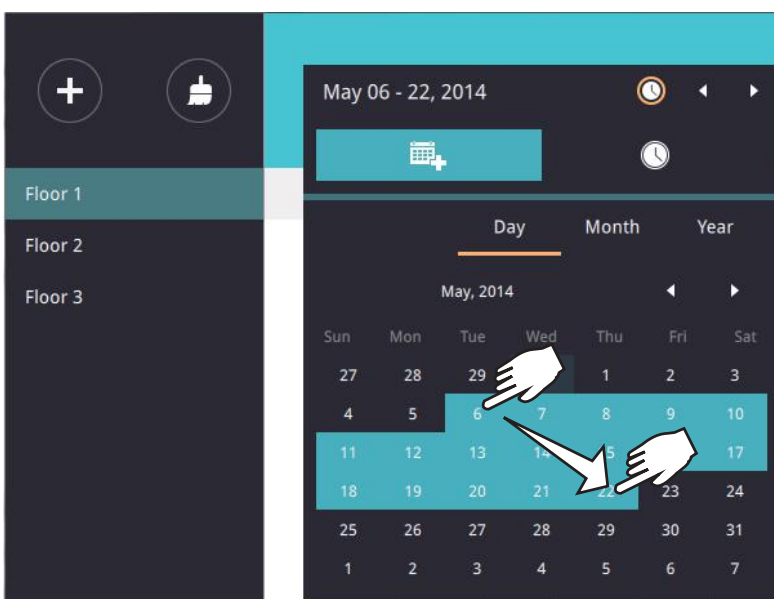

You can select a different month in the **Month** or **Year** panels. The **Calendar** panel disappears if left unattended for 2 seconds.

On a **Month** panel, double-click to select a month, and the **Day** panel for that particular month will display.

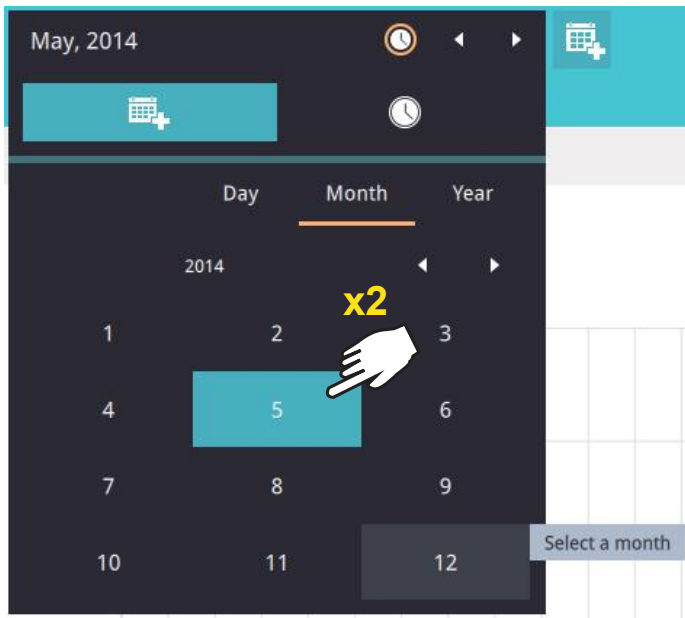

- When a date is selected, the Date and Time panel will not automatically close, and the configuration changes will not take effect until it is closed. You can click on the outside of the panel to leave the panel.
- You can select multiple days to form a span of time. Select one date with a single click and select multiple dates by dragging your cursor across the screen to a preferred end date.
- To select a year, click to open the **Year** panel. Single click to select a year. Multiple years can be selected using the click and drag method.

8. Select the hours to be included in the statistical poll using multiple clicks on the chart.

Single-click to select an hour or click and drag to select multiple hours.



Note that you can only compare the counting results from two spans of time if you select only one Area. If you selected multiple Areas, you can not compare the results from multiple time spans.

9. Click outside the Calendar panel. The statistical results will display. The default display is the bar chart. Below is a sample screen showing the results polled from 3 areas. Up to 8 areas can be selected in one view.

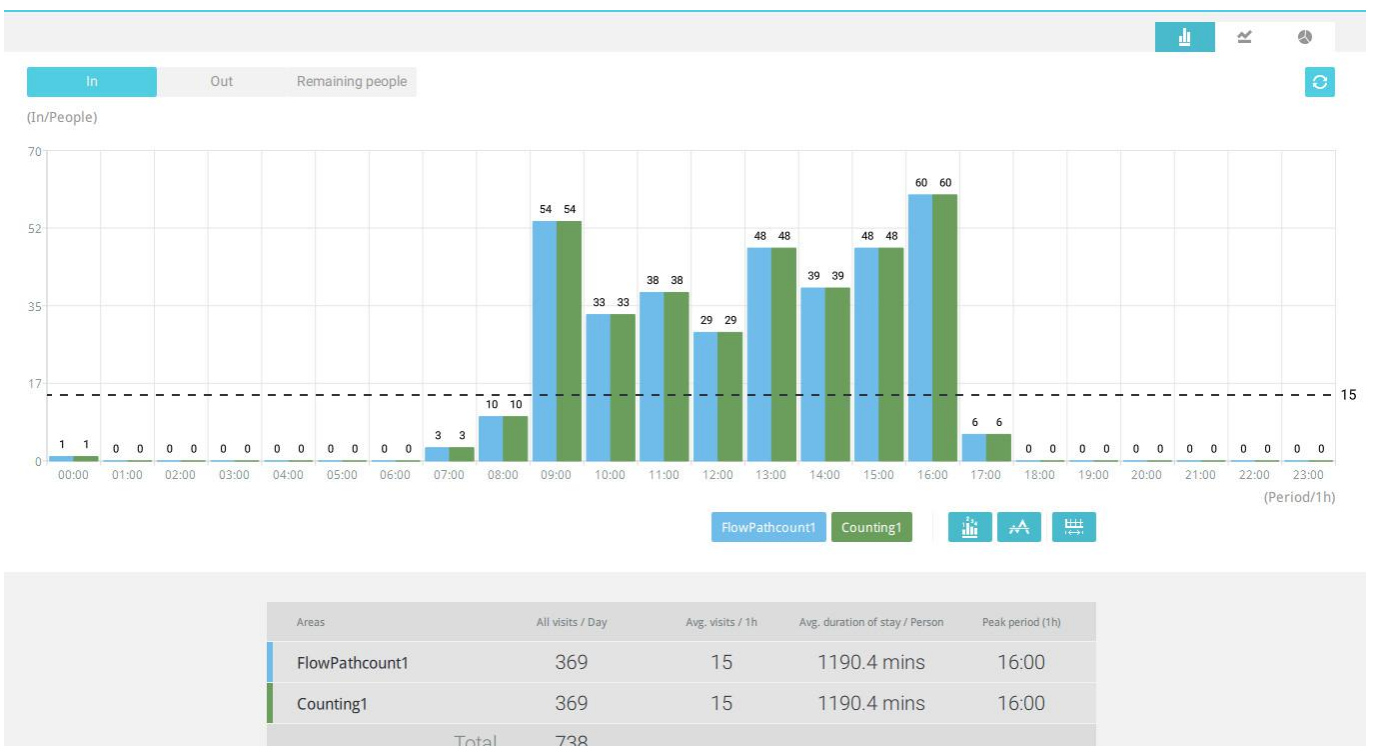

Select different display modes using the **Bar** , **Line** , or **Pie**  chart buttons.

### Line chart.

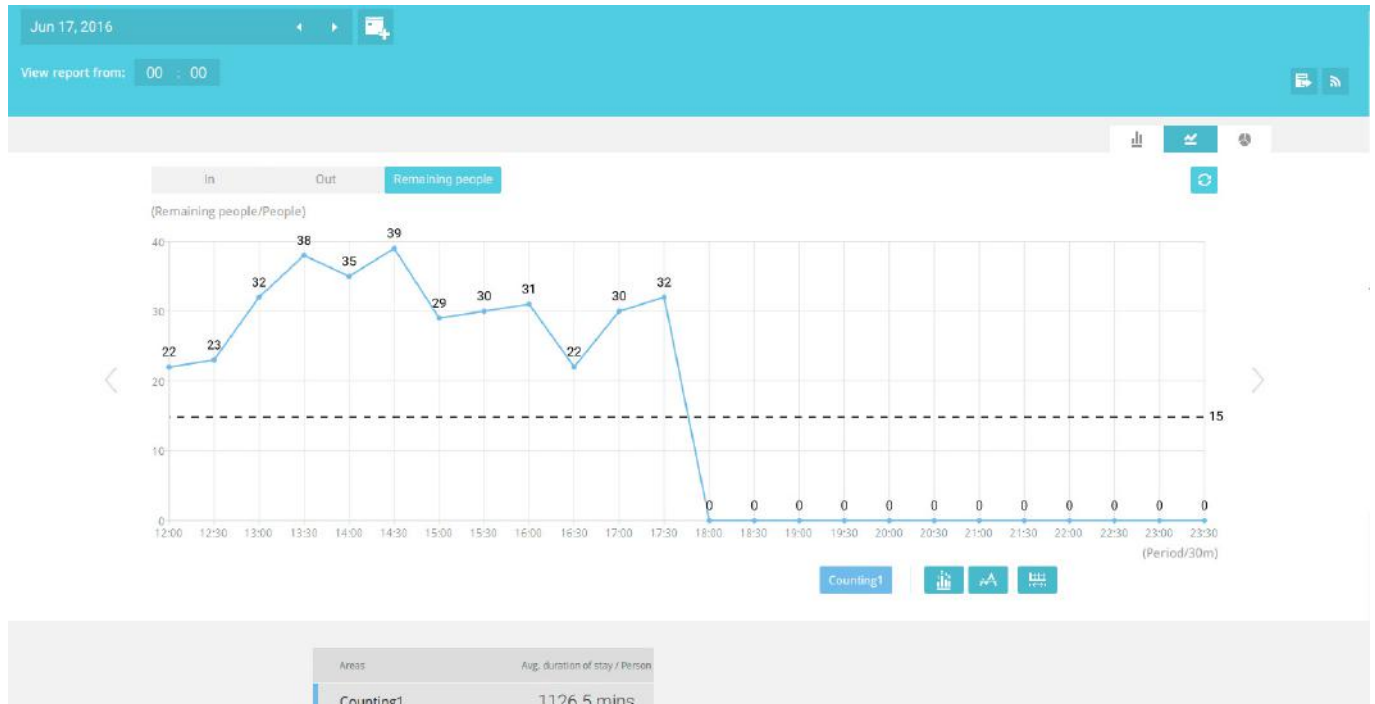

### Pie chart.

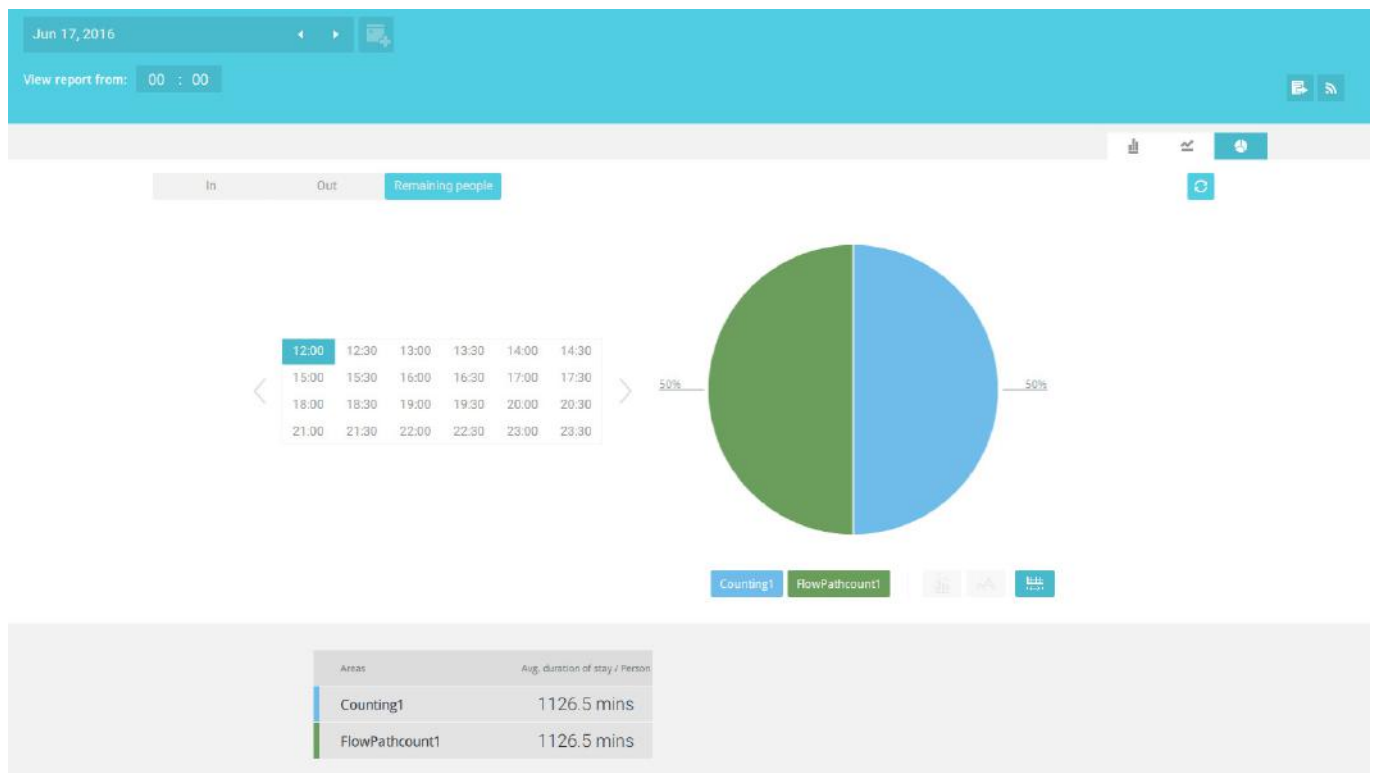

Note that the timeline units can vary depending on the span of time you selected on the Calendar panel. If a date was selected, hourly data will display in chart. If a year was selected, monthly data will display in chart.

Use the following functional buttons to change the display parameters

**Show data on chart**  : Displays the collected numbers on chart.

**Average**  : Displays the average number per time span unit (e.g., per hour). If the interval is changed to 30 mins, the average number will be halved comparing to the number acquired by every hour.

**Report Interval**  : Configure the intervals for polling data from the camera. The default for displaying results is by every hour. If you enter 30 minutes as the display interval, all data will be listed on the basis of the 30 minutes time span. The configurable range is 1 to 1440 mins.

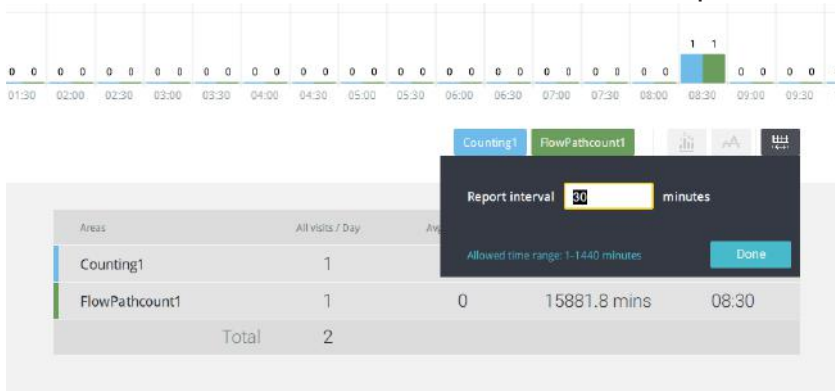

Use the **Refresh** button  to poll the latest data from camera.



Use the time selector on the **View Report from** pane to select the start time of your statistics view window. Data collected before that time will not be displayed.

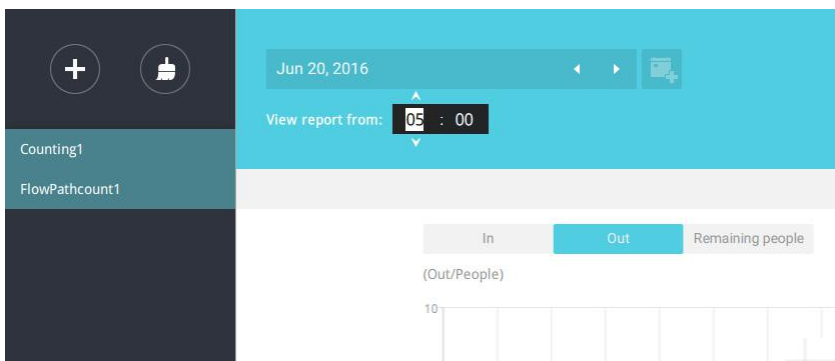

A number is displayed when you mouse over an area on the chart. Move your cursor to an area on chart, and the number is displayed.

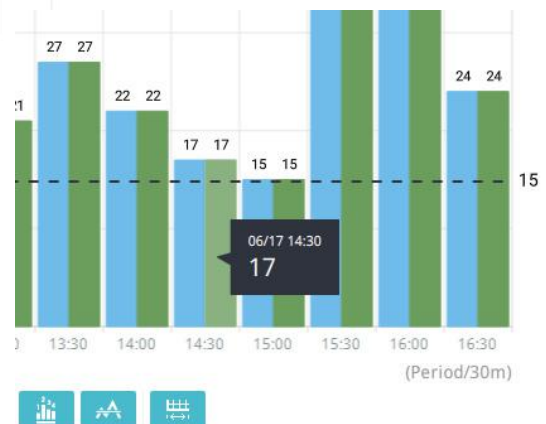



If you selected only one area, you can use the Shift key to select multiple areas (or two spans of time). You can select multiple dates in the Calendar panel.

Data on a time line will be generated. To close the window, use the close button on the second date information. Equivalent spans of time can also be used for comparison. For example, you can compare the data in a span of 4 days against another span of 4 days.

Note that the Compare function only applies when you select to display only one area on screen.

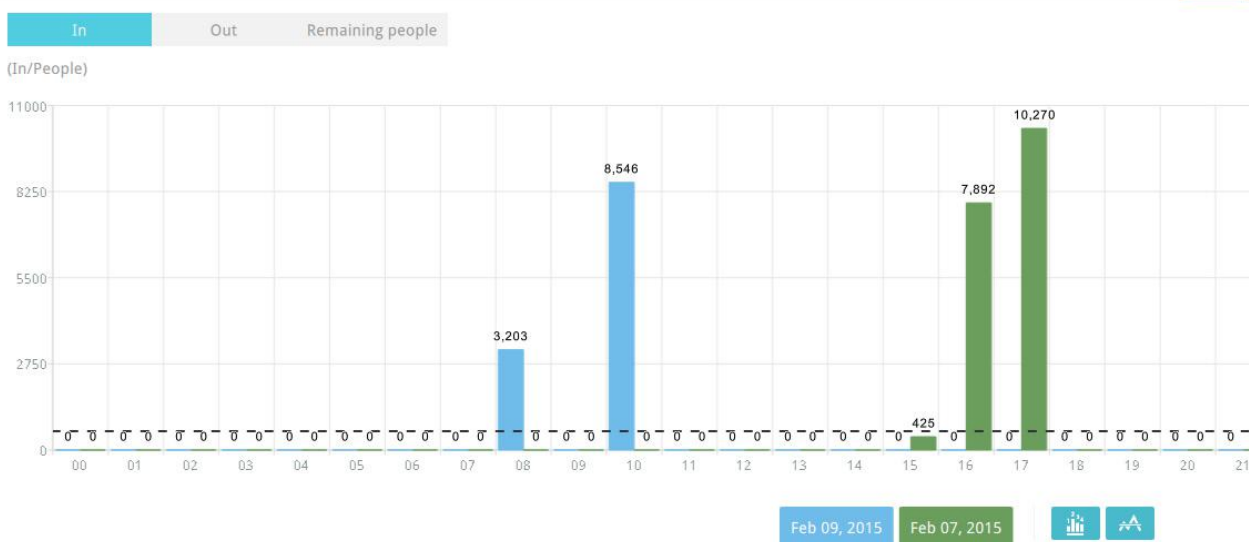

In a comparison result displayed in a line chart, mouse over to the peak value to display the percentage of an increase or decrease rate.



See below for the functions of buttons on screen.

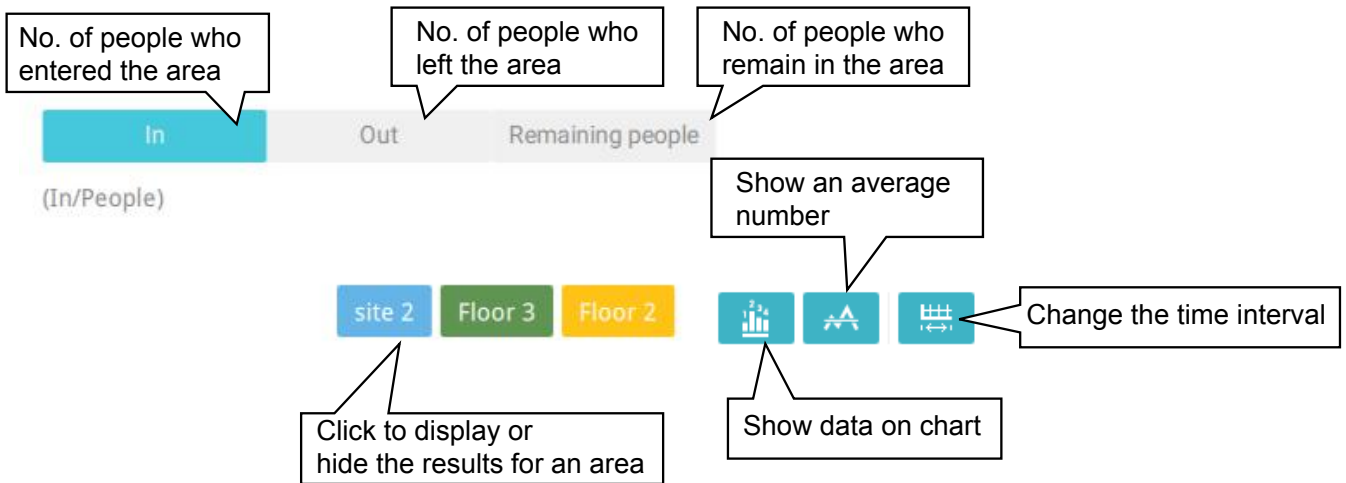

In addition to the charts, a summary of displayed data will be listed below showing the areas involved, visits/Day or Month, Average visits / Hours / Days, Average duration of stay / person, and the Peak hour.

Areas	All visits / 4 days	Avg. visits / Day	Avg. duration of stay / Person	Peak day
Floor 3	490,870	122,718	106.3 mins	12/04
Floor 2	959,482	239,870	105.9 mins	12/02
site 2	3,873,510	968,378	108.0 mins	12/01
Total	5,323,862			

10. When done with displaying the results, you can use the **Export**  button to produce an image file to preserve the current results. Both a spreadsheet and a graphic chart will be produced.

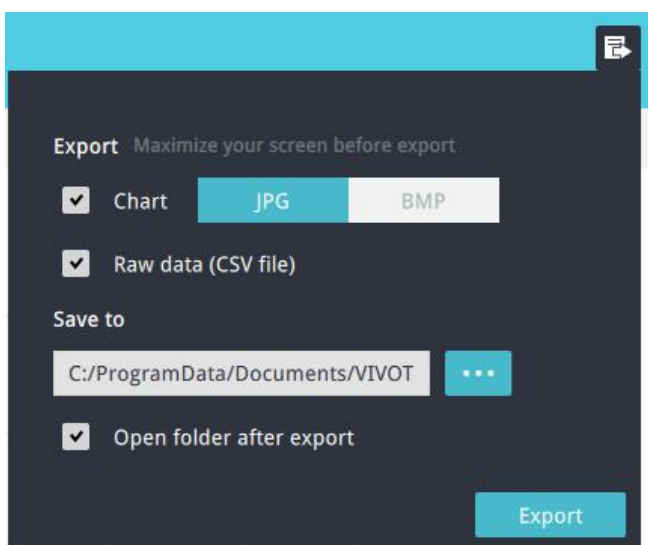



- Click the Reports Subscription button to configure the regular report sent to your Email account or a specific location on the server itself. Select the report chart image in JPEG or PNG, and CSV data files. Slide the email button to enable the Email notification.

Select the time to deliver your mail notification. Enter valid Email addresses as the sender and receiver addresses and make sure the SMTP mail server configuration has been properly configured on your VAST server. This VCA mail notification utilizes the mail service on VAST for regular notification. You can then receive Email notification every day on your Email account. You can enter up to 5 recipient addresses.

Reports

Chart JPG PNG

Raw data (CSV file)

Sent at

Subscribe by email

From

Full name

To

SMTP Setup Live Client > Configuration > Station settings > Server settings > SMTP settings

Subscribe by sending to server

Location  ...

Send now Apply

Peak period (30m)

Note that the notification contents is your current field of view, including a Bar, Line, and Pie chart combined into one image file. The In/Out/Remaining results will be generated into 3 charts. Each Area will generate one CSV file, and each CSV data file will contain In/Out/Remaining/Summary information.

The generated file names will look like this: 20160226\_test02\_Remain.jpg for charts and 20160226\_Summary.csv for CSV files. The Email subject will be "VCA Daily Report - 2016/02/26."

Note that if you manually export a report, the default is sending the data collected until one hour before the manual export. For example, if you generate the report at 14:07, the report will only cover the data collected until 13:59. You may use the Refresh button to manually

immediate data inputs (those occurred between 14:00 and 14:07).

Below are the messages with the Email test function.

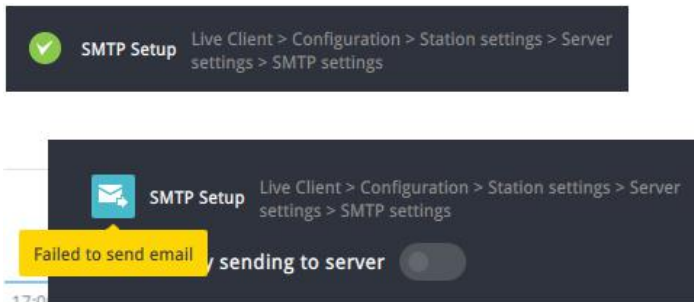

- If changes have been made to the VCA People Counting configuration through a web console, Refresh the connection with a network camera from the Device Tree. You can left-click to select a camera and right-click to display the **Refresh** command.
- The object height information detected by cameras is displayed on screen. You can select to display such information in centimeters or inches in **Configuration > Client Settings > View Settings**.

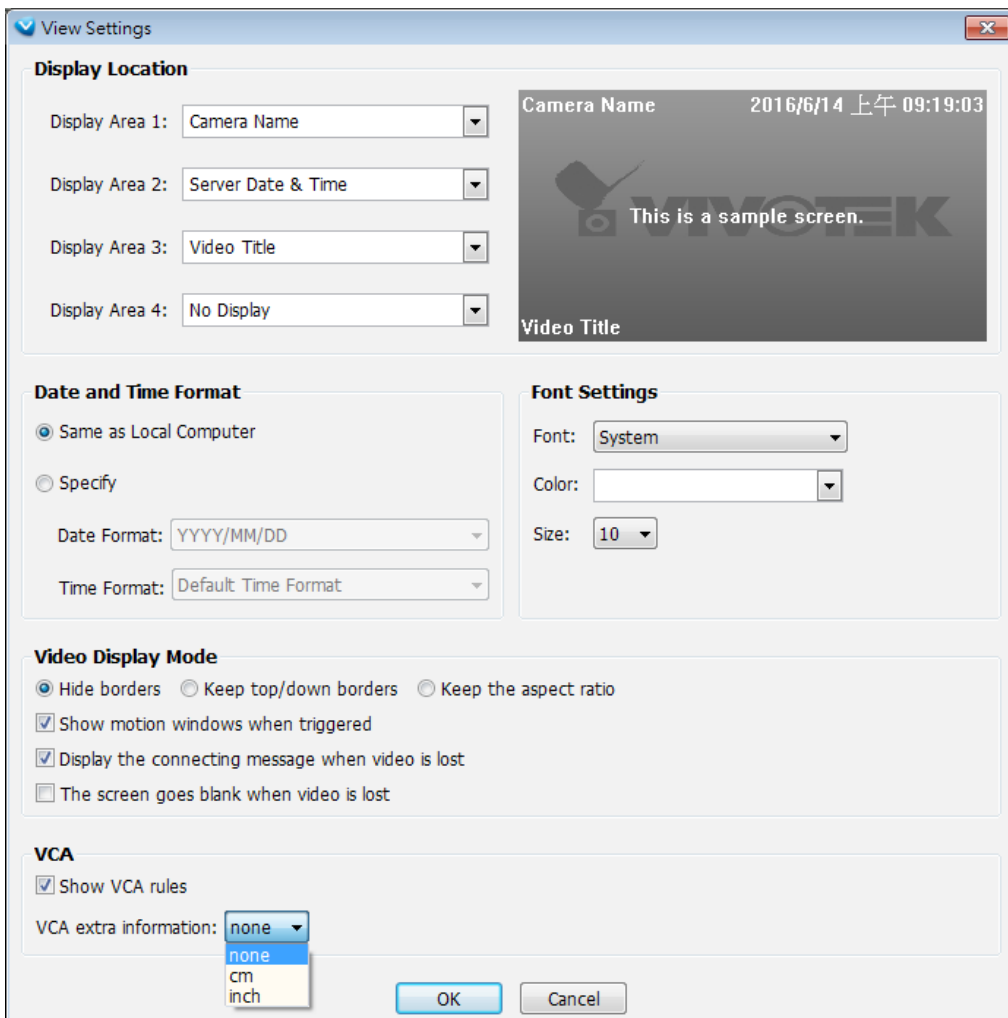

## Appendix E Support for Digital I/O Modbus TCP Modules

This revision, rev. 1.9, supports Advantech's I/O Modbus TCP Modules 6000 series. The VAST server can receive digital inputs and trigger digital outputs via the I/O modules.

The Advantech I/O modules come with configuration utilities, such as the Adam/Apax.NET. Connect the DI/DO wires to the module and the Ethernet wire from the module to the local network.

Proceed with the following to configure the I/O module:

1. Use the Search function to locate the I/O module on the network.

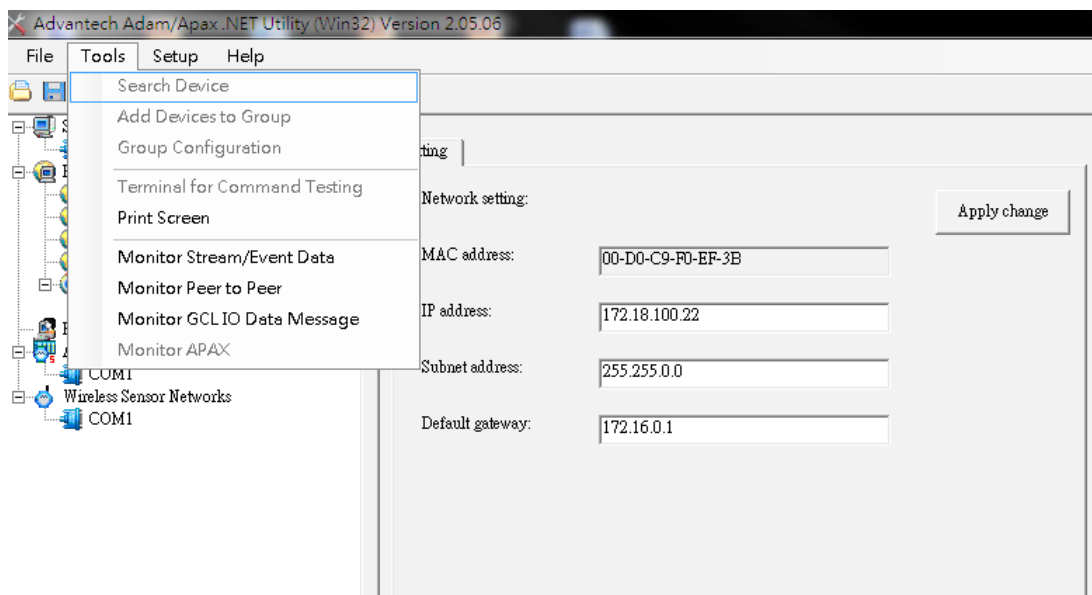

2. It is recommended to configure a static IP for the I/O module.

3. You may then test the DI/DO device connectivity using the software utility.

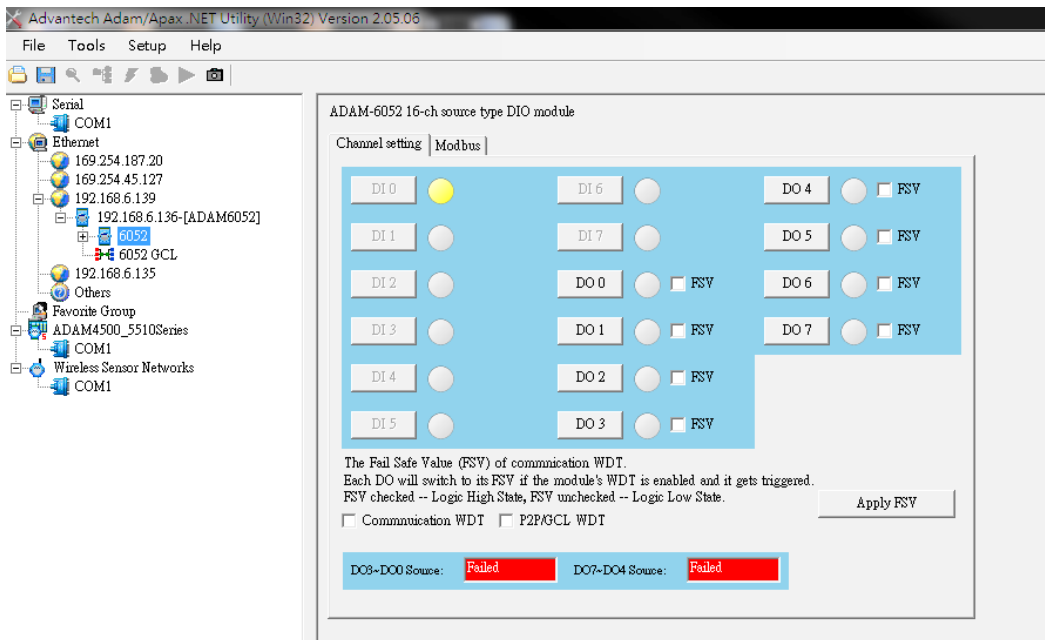

4. To configure the I/O modules in VAST, open the **Configuration > I/O Box Management > Insert I/O Box Device** window.

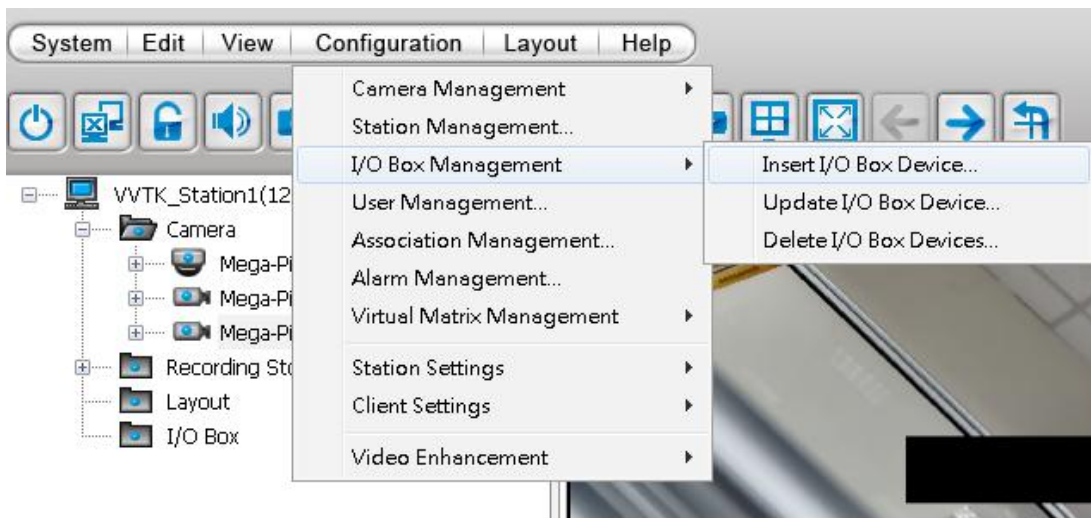

5. Select the Module model name, enter IP address, User Name, Password, and then click the Insert button.

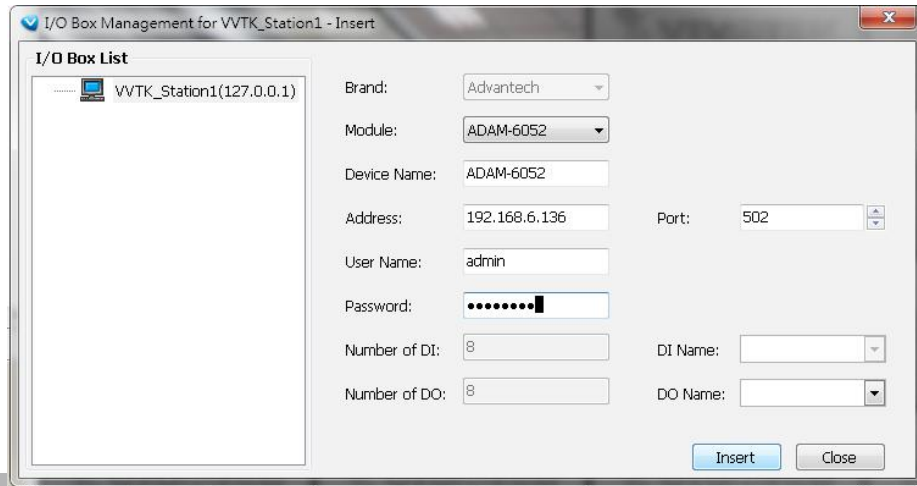

6. Click Close to close the window. The I/O module and its DI/DO entries should be listed on the device tree under the I/O box sub-directory. As shown below, once a DI is triggered from the I/O module, the associated DI icon will be lighted. Audible notification can also be heard from the VAST server.

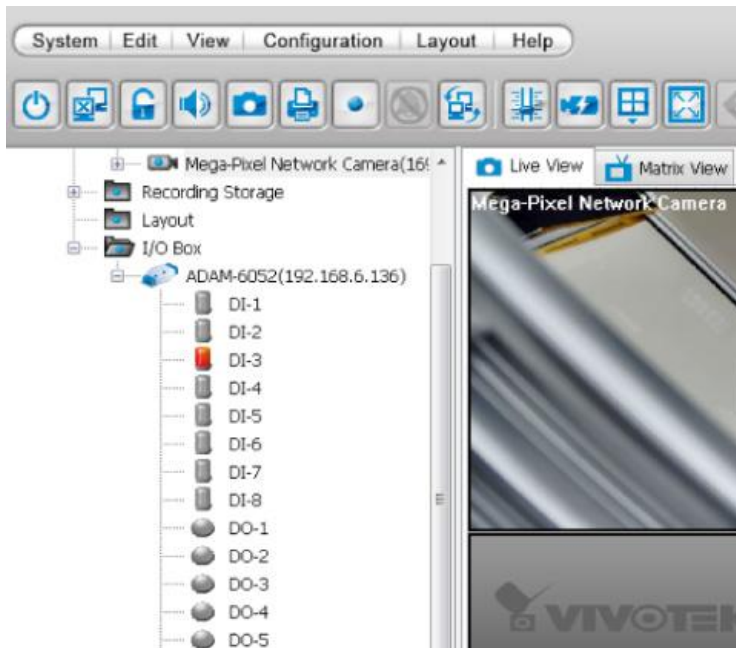

7. You can also double-click on a DO icon to manually trigger the digital output. Double-click again to cancel the trigger.

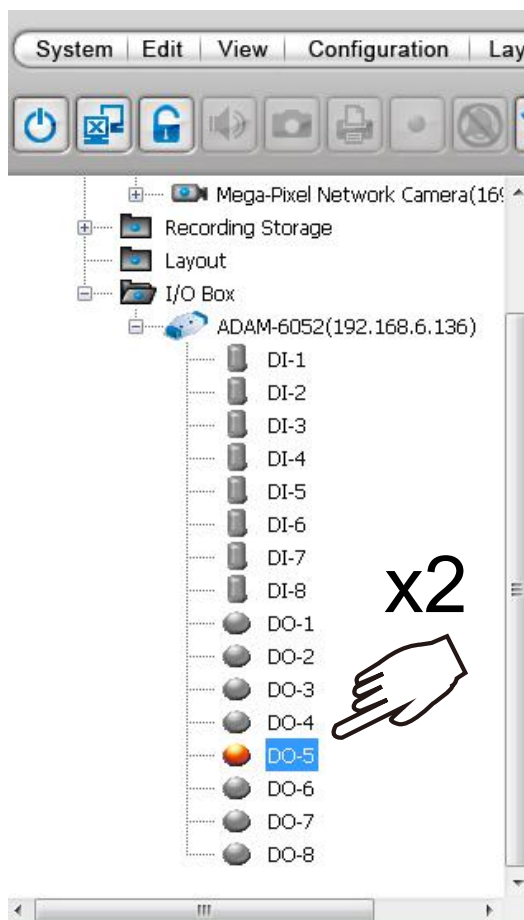

8. You can also implement the digital inputs and outputs from the I/O module in your alarm setting. For example, a DI can be wired to an intrusion detector; and when the DI is triggered, an associated DO can be used to sound an alarm.

To configure the Alarm setting, enter the **Configuration > Alarm management** window. Configure a new alarm. On the Trigger window, select the Trigger Category as **External Device Events**.

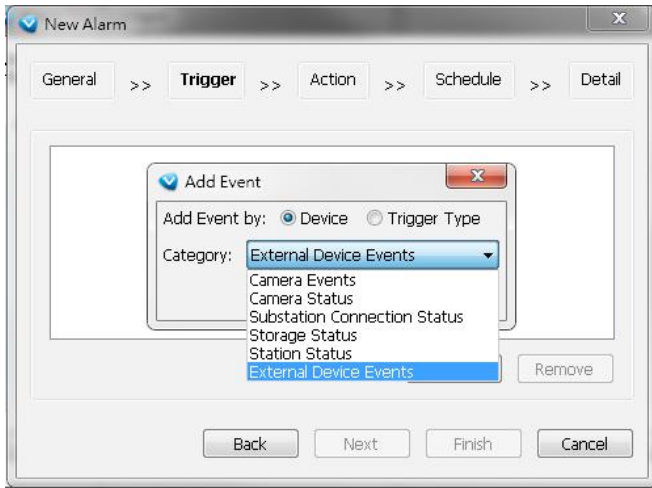

9. The DIs and DOs on the I/O module will be listed. You can then select one or more DIs as the triggers.

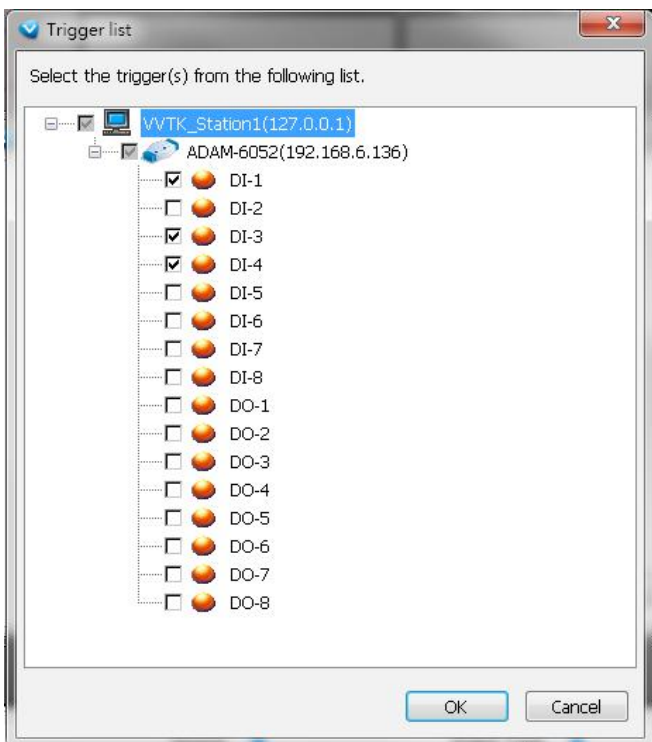

10. On the Action panel, you can select to trigger DOs, for example, as the reacting actions

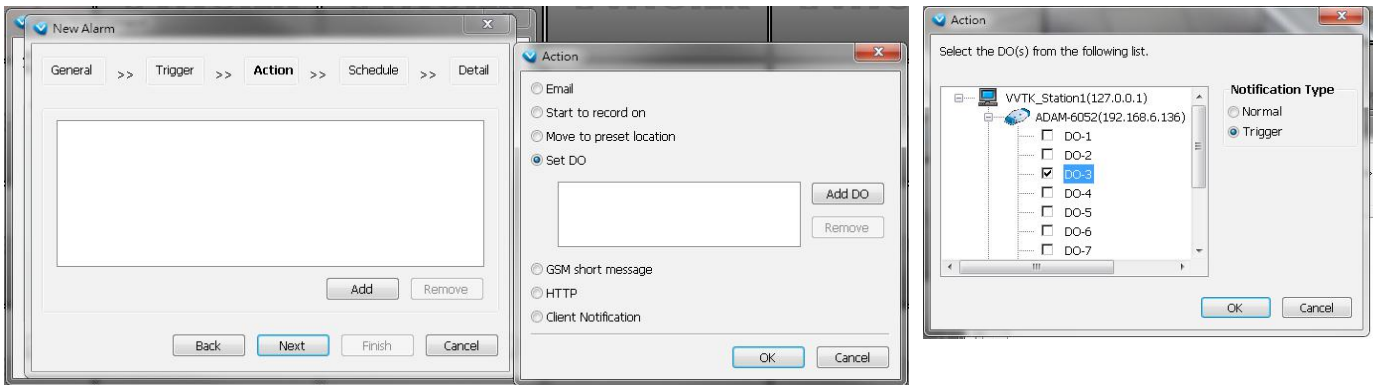

Note that once a DO is triggered, you should manually disable the DO.



If an I/O module is started later than the VAST server, you may not be able to access the I/O module. You should then re-start the VAST service.

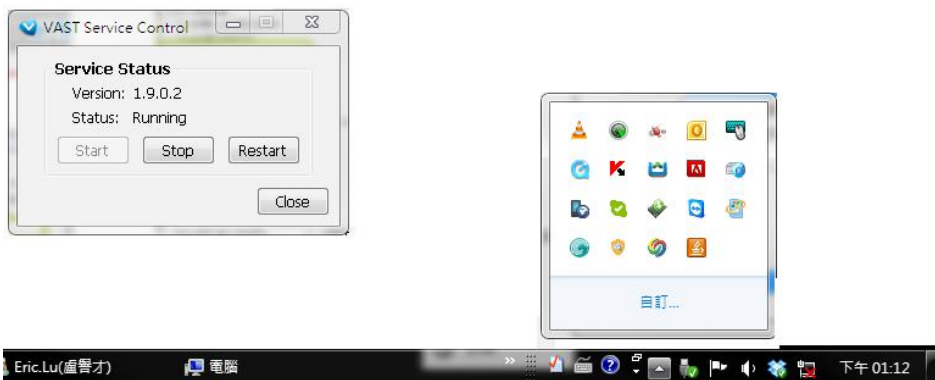

## Appendix F Database Merge Function

The Database Merge function applies in the following scenario:

1. A VAST server A failed or was intentionally depleted. The precondition is that the disk drives containing the recordings remain intact.

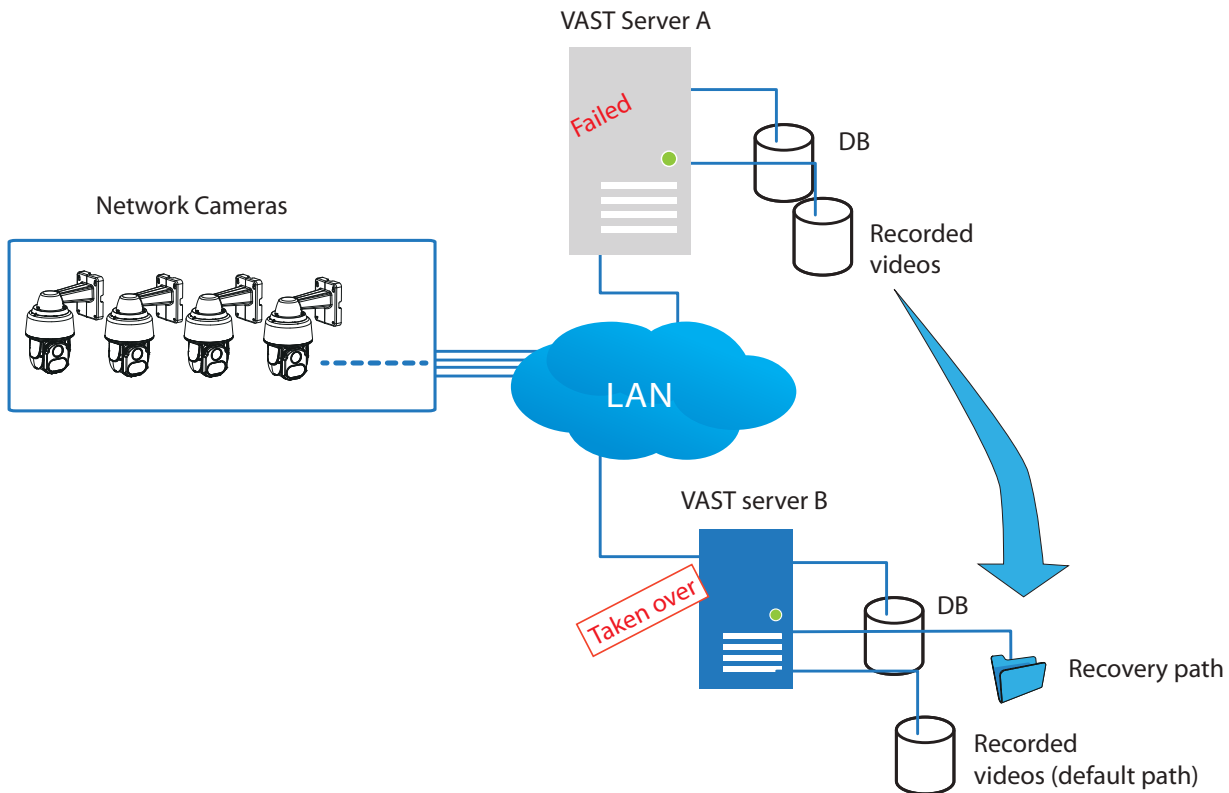

2. The VAST server B is used to continue video recording. The previous recordings on server A can be retrieved by attaching the hard disk(s) to server B or manually copying to a storage device on server B. You can then designate the location of these files as the "Recovery path" from server B. An administrator can then use the VAST Playback to access the past recordings.

Note that you can also configure a separate recycle policy for that Recovery path.



- It is **IMPORTANT** to move or copy the entire storage group folder, e.g., `D:/recording/2016-06-17/1-FE9181-H...`, which is a root directory configured by VAST server as the recording folder. The default recording folder contains file folder structure, video files, and database metadata. If you copy the video files only, the database data will not be synchronized, and you will not be able to access the recordings using the VAST Playback utility.
- The video streams received from cameras will not be recorded on to the Recovery path folder. It is designed to maintain previous recordings. The Recovery path folder becomes static.



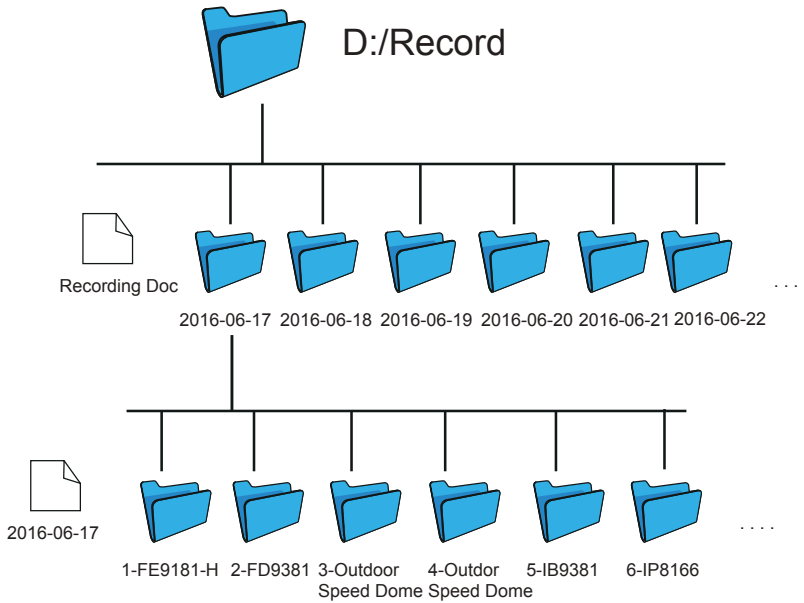

- It is also a good habit to export and preserve your VAST system configuration to prevent losses in the event of system failure. In case you want to migrate or upgrade your VAST server, you can use the Import-Export utility to duplicate your VAST configuration to another server. Copy the configuration file and import the configuration from another VAST server.

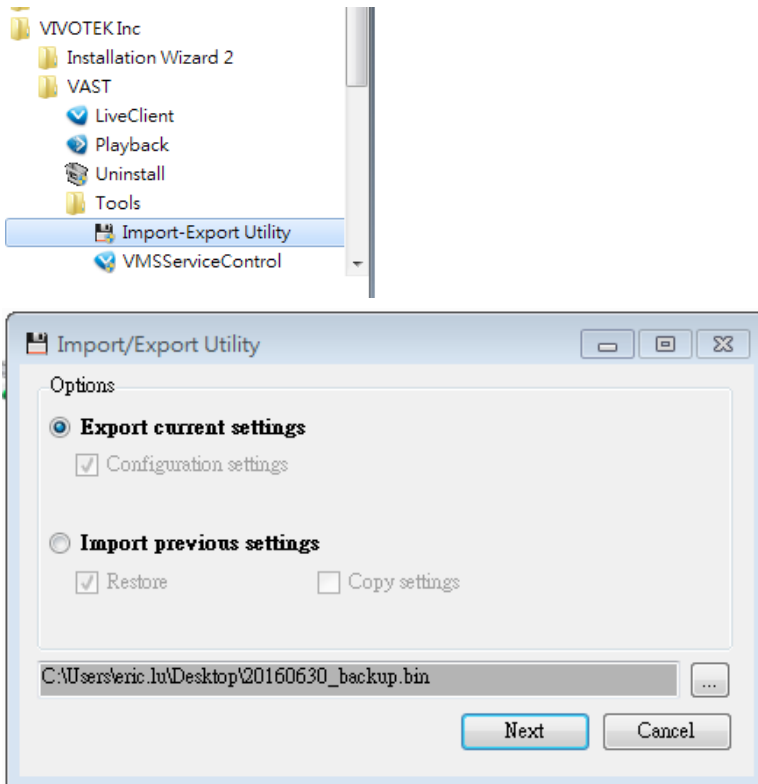

When the file folder is ready for server B, designate the location of recovered files from another VAST server, go to Configuration > Station Settings > Recording Storage Settings.

Select the recording folder that contains the recordings from the counterpart VAST server. Select the **Recovery Path** check circle and click **OK**.

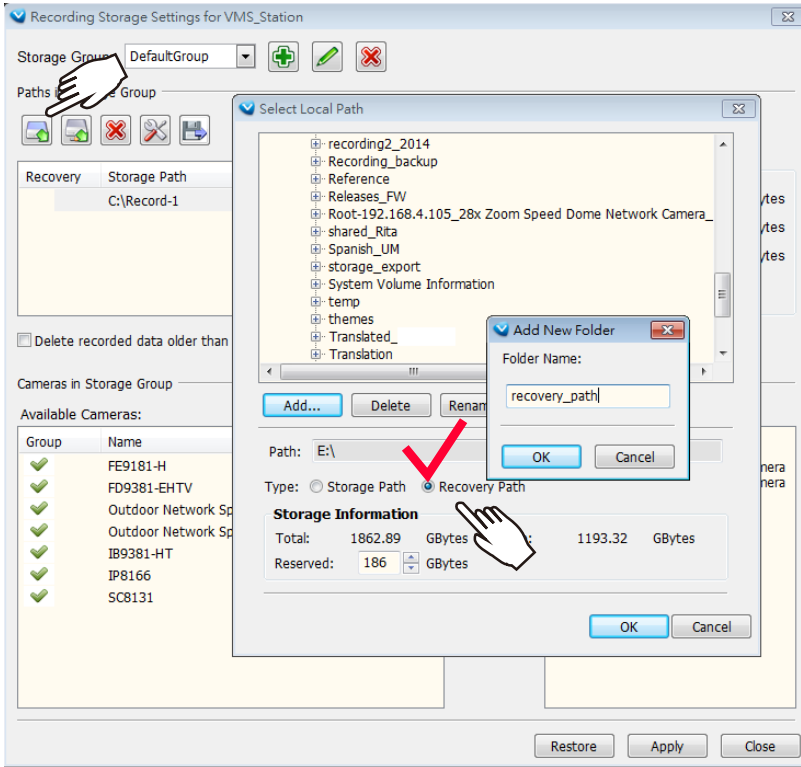

Click the Apply and Close button.

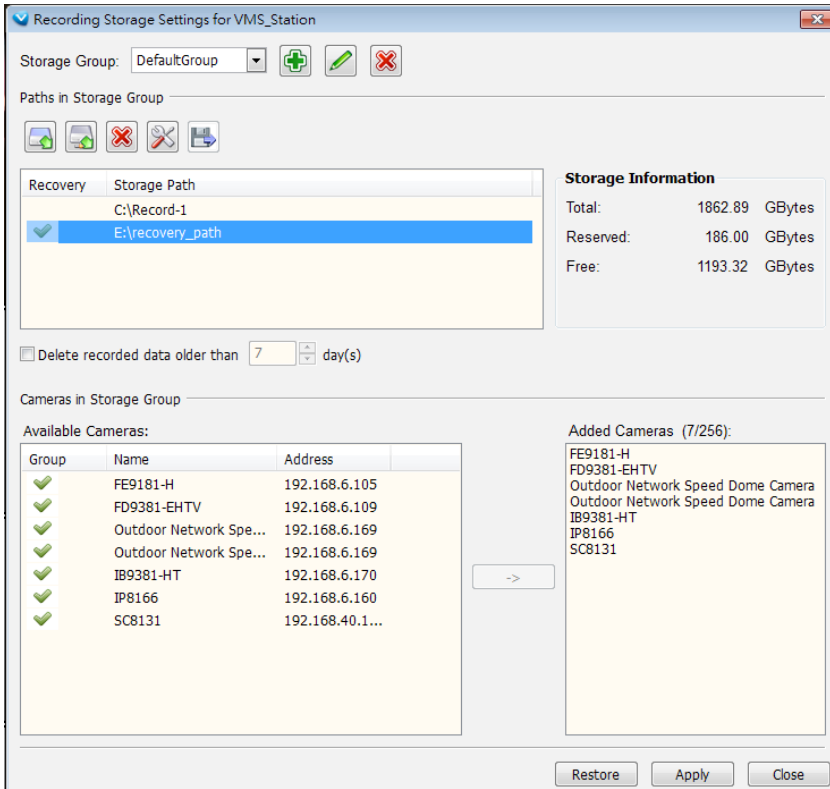

If you are running the **Playback** utility, close and re-start the Playback utility. Open the device tree, and you should be able to see previous recordings listed under each camera. This indicates previous recordings can be accessed from the recovery path and the databases on the two VAST instances have been synchronized.

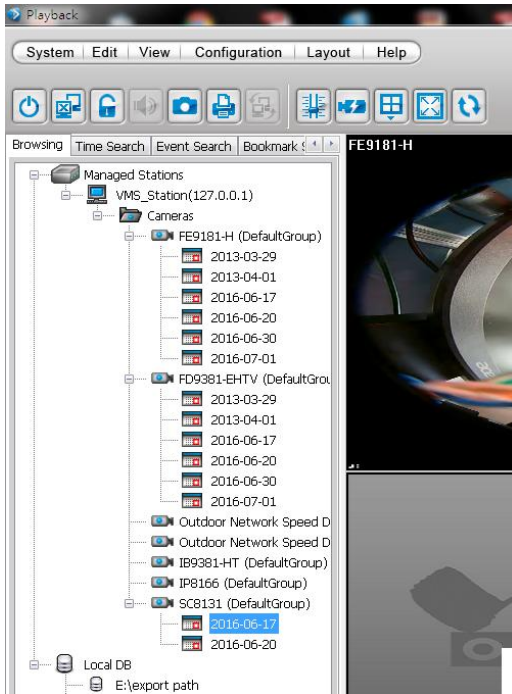

In addition to the use of Recovery path, if you need to access the recordings made by a different VAST server, you can also manually copy the entire storage group folder, such as D:/recording, to a hard drive or a network share, and then avail the recordings on the new server.

Different from the use of Recovery Path (Database Merge), this scenario applies to two VAST servers with different configurations.

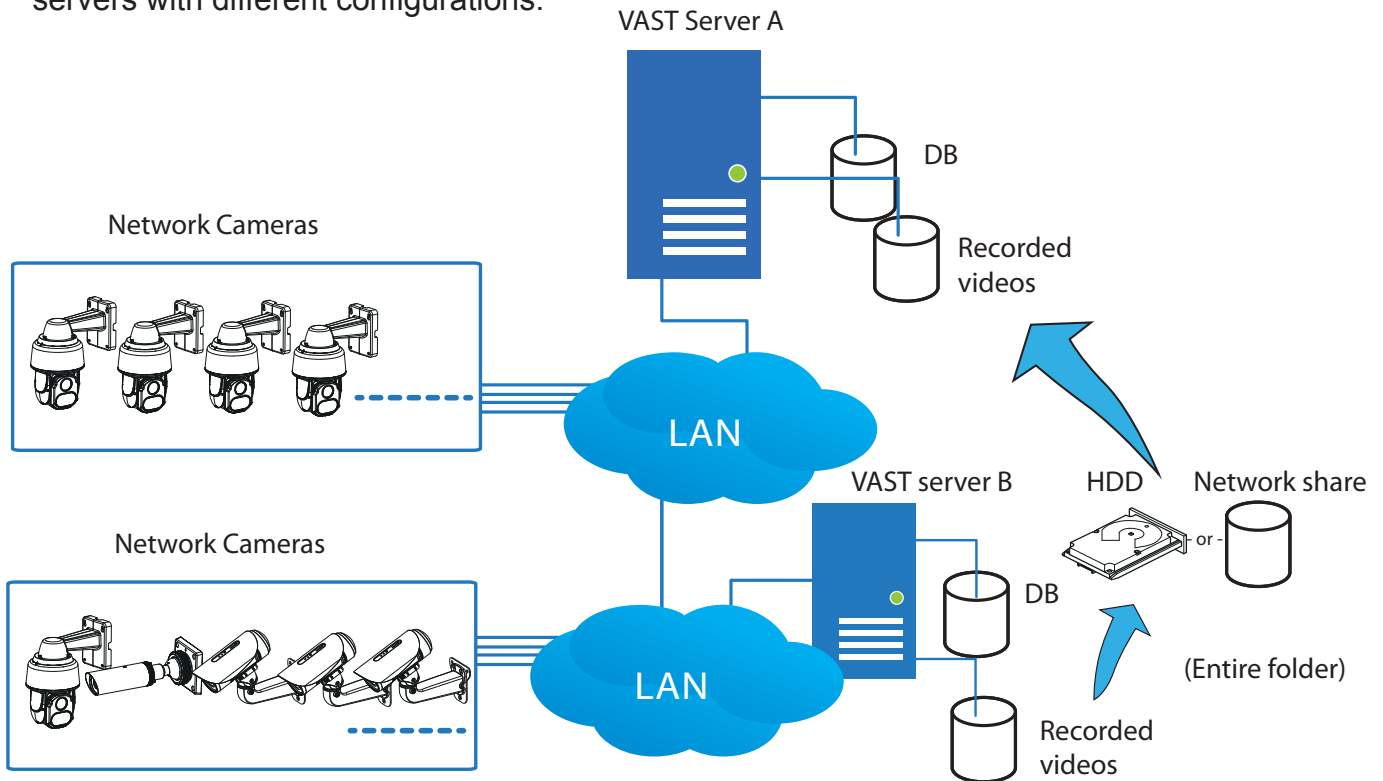

On the Playback window, right-click the Local DB icon to display the **Add** command. Select the folder where the recordings reside. The recordings should be listed under each of the cameras.

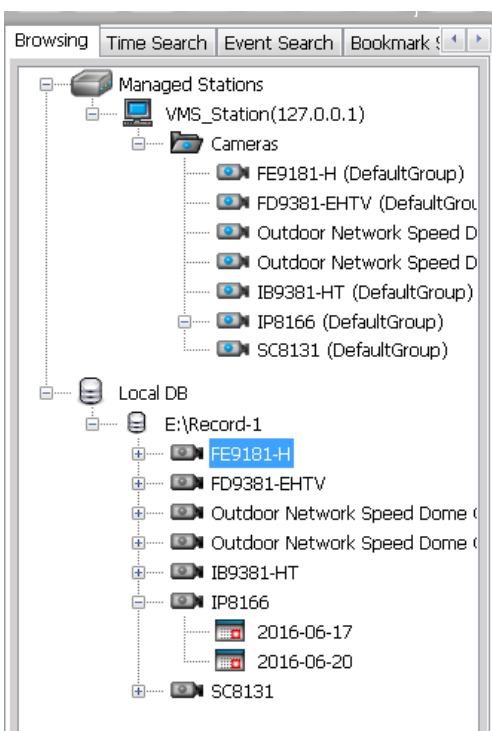

Note that as the folder structure remains intact, you can still manually remove some of the video files within, if they are not of your interest.

The **Export Storage** is another backup function.

To export video recordings to a specific target folder, enter Configuration > Station Settings > Recording Storage Settings. Click the Browse button to select a target folder.

Select the default storage group, click on the **Export** button . Select all cameras (default) or manually select specific cameras from the list. If you want to select individual cameras, use the arrow buttons to move cameras to the right column. Select the time span of the export using the selectors below. The minimum span is one day. Click OK to proceed.

Note that the videos thus exported can not be indexed in the Playback utility's device list. Each video clip should be watched individually.

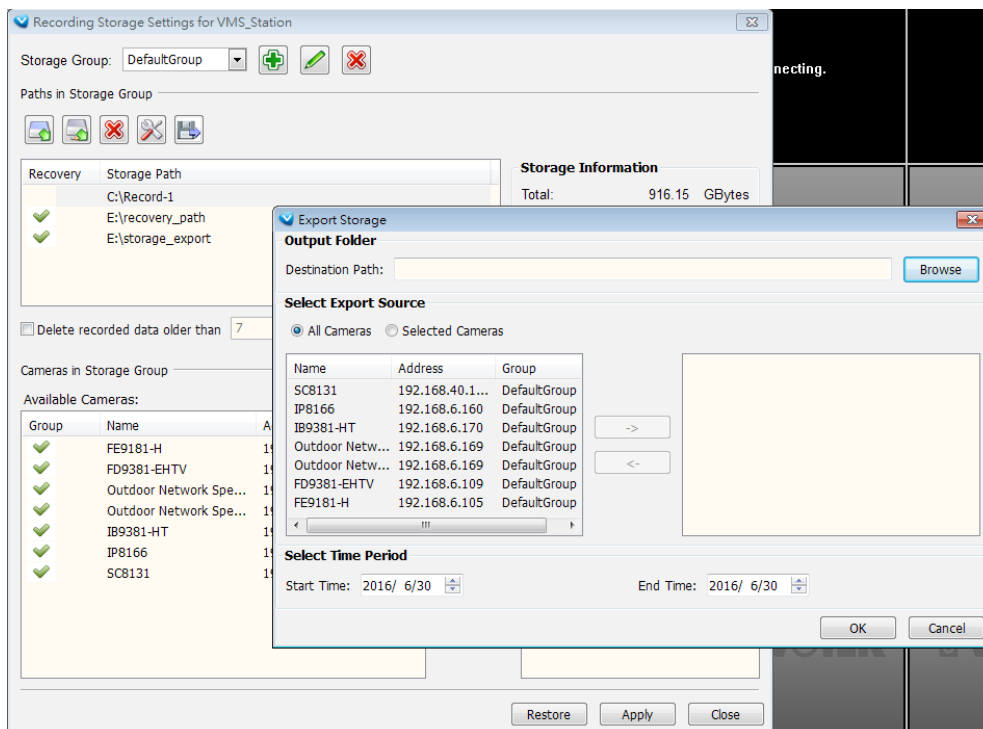

Depending on the length of time span and the number of selected cameras, the export process may take several minutes or longer to complete.



- If the members of the original VAST configuration (cameras) have been changed, the VAST server will not be able to locate the original MAC addresses, and may not be able to retrieve past recordings.
- The **Export Storage** function only takes effect on the VAST server local console. It is not available on a web console.

## Appendix G Other Parameters

Disable background decode:

Administrators can choose to disable the background decode for other view cells when entering a single view of a specific camera. This can help reduce the CPU load on a server short of system resources.

This function can be evaluated in two aspects:

1. For a server with abundant system resources, there is less stress when disabling and enabling background decode. When a user leaves a single view and enters a multi-cell view, the background decode starts again, and a powerful server handles this process more smoothly.
2. For a server with less resources, this feature can reduce CPU load. However, latency can occur during the process when returning from a single view back to a multi-cell view.

This feature is enabled by editing the ClientSetting.ini file in <C:\ProgramData\VIVOTEK Inc\VAST\Client\LiveClient>.

```
64 [GeneralSetting]
65 AutoFullScreen=0
66 AutoAddCam=1
67 SSE=1
68 EnableRTSP=0
69 RTSPPort=4543
70 StreamingRelay=1
71 SubscribeCamera=0
72 SortCamera=0
73 LiveEvent=1
74 LocalAlert=0
75 EventWindowType=0
76 RotateSec=10
77 AutoRotate=0
78 DeInterlace=0
79 SyncAudioVideo=0
80 AutoStreamSize=1
81 AutoStreamSizeMode=0
82 InstantReplay=1
83 DefaultPlaybackLength=1
84 BufferTime=0
85 GDIOnly=0
86 GPUDecode=0
87 GPUDecodeMaxNumber=0
88 MinPTSpeed=-1
89 MaxPTSpeed=-1
90 DisableBackgroundDecode=1
```