



Pager7

Universal alarm system with built-in communicator

USER MANUAL



FOR MODULE VERSION V3 AND NEWER

Dear customer!

Thank you for choosing our product. This manual contains important information about installing and remote controlling the module.

Please read this document carefully before using the product!

The latest version of the product's remoter software and user manual are downloadable from the manufacturer's website:

<http://tell.hu/en/products/gprs-communicators/pager-7>



Main features:

- 4G/3G/2G communication (depending on the module version)
- 6/4 configurable NO/NC zone inputs
- 1/2 NO relay output: remote controllable by event
- Configurable event-action pairs
- Configurable active dashboard with active tiles at will
- Configurable Contact IDs for every input and custom event
- E-mail sending, SMS sending and voice call functionality
- Multiplatform application (Windows, Linux, MacOS)
- Cameras can be assigned with zones to display and record their images in case of an alarm
- Independent alarm function
- Support of TELLMon / SIA IP protocol

Application area:

- Mini alarm system
- Provide surveillance functions with security cameras
- Connection alarm systems with monitoring stations
- Using in building engineering (control based on sensor information)
- Agricultural use (control based on sensor information)

Table of contents

1. System operation and technical details	4
1.1 The module's short description	4
1.2 Automatic power disconnection function	4
1.3 Data traffic	4
1.4 Processing of personal data	5
1.5 Technical specification	6
1.6 Contents of the package	6
2. Mounting the module and putting into operation	7
2.1 Module version	7
2.2 Inputs and outputs	7
2.2.1 Connecting inputs	7
2.2.2 Connecting temperature sensor	7
2.2.3 Connecting outputs	7
2.3 Powering the module	8
2.4 Wiring	8
2.4.1 Wiring of Pager7 IN4	8
2.4.2 Wiring of Pager7 IN6	9
2.5 SIM card related information	9
2.5.1 Selecting services	9
2.5.2 SIM card holder	10
2.6 Connecting the antenna	10
2.7 Installation environment	10
2.8 Putting into operation	11
2.9 LED signals	11
3. The programming software	11
3.1 User levels	11
3.2 Logging into the programming software through USB connection	12
3.3 Logging into the programming software through internet connection	12
4. Programming the module	13
4.1 The module	13
4.1.1 Module settings	14
4.1.2 Module status	17

4.2 Inputs/outputs	18
4.3 Cameras	20
4.3.1 Camera settings	21
4.3.1.1 IP Camera detect application	21
4.3.2 View cameras	21
4.3.3 Playing records menu point	22
4.4 Configuring active dashboard	22
4.4.1 Adding widgets	22
4.5 Notification settings	24
4.5.1 Phone numbers menu point	24
4.5.2 Text templates menu point	25
4.5.3 Emails menu point	25
4.5.4 Sounds menu point	25
4.5.5 Push notifications	26
4.6 Alarm settings menu point	26
4.7 Signalling to monitoring station	26
4.7.1 Surveillance settings menu point	27
4.7.2 Surveillance schemas	29
4.8 Event settings	30
4.8.2 Actions	33
4.8.3 Presets	35
4.9 Log, configuration and debug	35
4.9.1 Log menu point	35
4.9.2 Configuration menu point	36
4.9.3 Debug information	36
5. Alternative programming options	37
5.1 DTMF commands	37
5.2 SMS commands	38

1. System operation and technical details

1.1 The module's short description

The Pager7 is a versatile 3G-based or 4G-based (depending on the module version) communicator module, that can be used to perform small automation tasks, surveillance tasks (with camera management) and it can also be used as a stand-alone security system. The product's speciality is the multiplatform application for programming the device remotely through the internet or via USB.

1.2 Automatic power disconnection function

The product is provided with built-in automatic power disconnection function. If the supply voltage drops below 8.3V, the module turns off automatically and it turns back on when the supply voltage is at least 11.6V.



Attention! The minimum supply voltage level required to turn the module on is 11.6V! After turned on with supply voltage higher than 11.6V, the module can operate stably even at lower supply voltage, but not lower than 8.3V.

If the module is powered from a power supply provided with a backup battery and there is no other electrical load on the battery when charging fails (e.g. in case of a power cut), while the battery discharges, the module turns off automatically at 8.3V voltage level.

Thereafter, if the battery is in good condition, it can regenerate and can reach the terminal voltage of 11.6V where the module turns back on, then the battery may discharge again below 8.3V. This may result a continuous switching on and off cycle that lasts until the battery can no longer regenerate to the 11.6V voltage level. If this phenomenon occurs, the battery is flat and it should be replaced.

1.3 Data traffic

The estimated traffic on the SIM card inserted into the module is expected to be approximate ~20 MB per month by minimum usage. The data traffic rate depends on the frequency of use, the stability of the cellular network and the services used.

Data traffic generating services:

- Remote programming/controlling
- Reporting to a monitoring station
- Downloading event log and configuration remotely
- Firmware upgrade
- Notification sending (e-mail, voice call, SMS)
- Report sending

The rate of data traffic depends on the usage frequency and duration of the services listed above.



Attention! The actual data traffic can be the multiple of the minimum usage depending on the used services!

1.4 Processing of personal data

For using some of the features the users need to specify certain personal information, just like their notification email address and phone number, SIM card's PIN code and the location details of the device. This personal data is only required if you want to use features like e-mail notification sending.

Users' consent to processing their personal data shall be deemed to be given on the basis of their clear and explicit consent by providing voluntarily the personal data in a direct or indirect way. The purpose of personal data processing is to ensure access to the system and thus to provide permission of use for users who wish to use the system. The system stores the personal data in the device's memory.

The personal data are not accessible for third party, only for the system operator/installer and the assigned system administrators. The assigned system administrators are obliged to treat the personal data confidentially, in line with the legislative provisions, and shall not disclose the data to third party.

The Manufacturer takes any kind of responsibility for and in connection with the functionality and use of the system – including proper use of hardware and software – according to the relevant provisions of law.

1.5 Technical specification

Supply voltage:	12-30 V DC
Nominal current consumption:	120mA
Maximum current consumption:	500mA @12V DC; 250mA @24V DC
Maximum relay output load:	1A @ 24V AC/DC
Selectable modem types:	3G/4G
Dimensions:	84x72x32 mm
Weight:	200 g
Operation temperature:	-20°C - +70°C

1.6 Contents of the package

- Pager7 + terminal connector
- GSM 900/1800MHz antenna
- User manual
- Warranty card

2. Mounting the module and putting into operation

2.1 Module version

The module has two versions. The first has 4 contact inputs (IN1...IN4) and 2 relay outputs (OUT1, OUT2) – Pager7 IN4, while the second one has 6 inputs (IN1...IN6) and 1 output (OUT1) – Pager7 IN6.

For connecting the module correctly, wiring diagrams of the corresponding version must be used!

2.2 Inputs and outputs

 **Attention!** Do NOT connect the module's terminals directly or indirectly to the protective ground, because this may damage the module!

2.2.1 Connecting inputs

Both the inputs of the device and the event-actions for their activation can be customized, so the NO or NC wiring can be also used in accordance with the selected usage.

The normally closed and normally open contacts are considered between the selected input (eg.: IN1) and the negative „V”-terminal of the supply voltage and need to be connected accordingly.

For the proper operation of inputs, it is essential to specify the type of inputs (NO or NC) and enable them in the programming software. These settings are explained in detail in section 4.2 of this manual.

2.2.2 Connecting temperature sensor

Each input of the device is capable of handling temperature sensor (easyTemp). Connect the signal output of the temperature sensor to the selected input of the module and set the input type to temperature sensor in the programming software. This setting is explained in detail in section 4.2 of this manual.

2.2.3 Connecting outputs

The outputs of the device are normally opened (NO) so wire them accordingly to process the given task. The normally open (N.O.) output provides open contact by default and closed contact upon control. The maximum relay output load is 1A at 24V AC/DC voltage.

2.3 Powering the module

For powering the module 12-30V DC is required. The module's nominal current consumption is 120mA, however, it may occasionally increase to several times (up to 500mA at 12V DC). The incorrect power supply may cause the module to malfunction!

If the proper power supply cannot be assured otherwise, auxiliary power supply (230V AC/12V DC; 1A) can be ordered from the manufacturer.

An uninterruptible power supply with adequate power is essential for the product to operate properly. The power supply must provide a power that can serve the minimum operating voltage and the maximum power consumption of the device. The power feed must be continuous and transient-free even when there is a mains power failure, and the power feed switches to backup battery operation.

An ideal solution for the above purposes is the power supply designed and manufactured by TELL, which we expressly recommend using for our communicators.

- Recommended TELL power supply: **TT25VA-12V5**

2.4 Wiring

2.4.1 Wiring of Pager7 IN4

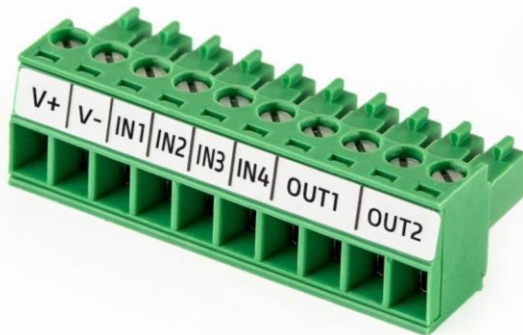

System terminal inputs and outputs:

- V+: Supply voltage 12-30V DC (min. 500 mA)
- V-: Supply voltage negative polarity
- IN1: 1. contact input
- IN2: 2. contact input
- IN3: 3. contact input
- IN4: 4. contact input
- OUT1: 1. normally open relay contact
- OUT2: 2. normally open relay contact

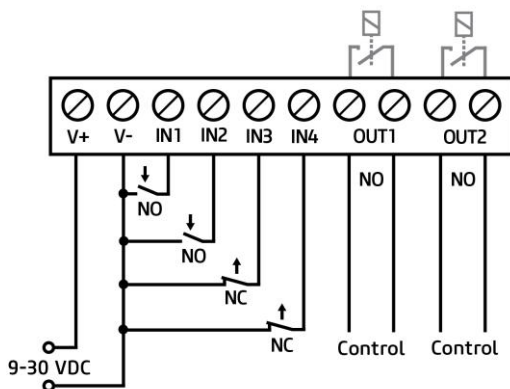

In our example IN1 and IN2 inputs are normally open (NO), while IN3 and IN4 are normally closed (NC) inputs.

2.4.2 Wiring of Pager7 IN6



System terminal inputs and outputs:

- V+: Supply voltage 12-30V DC (min. 500 mA)
- V-: Supply voltage negative polarity
- IN1: 1. contact input
- IN2: 2. contact input
- IN3: 3. contact input
- IN4: 4. contact input
- IN5: 5. contact input
- IN6: 6. contact input
- OUT1: 1. normally open relay contact

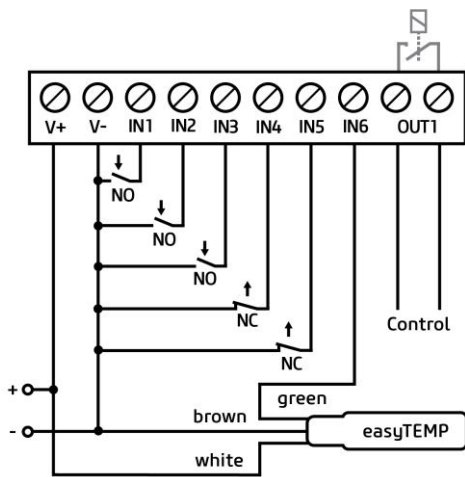

In our example IN1, IN2 and IN3 inputs are normally open (NO), IN4 and IN5 inputs are normally closed (NC), while IN6 input is a temperature sensor (easyTemp).

2.5 SIM card related information

2.5.1 Selecting services

To select which services to activate on the SIM card, you need to know what features of the device you'd like to use in practice.

Several features of the module require having a mobile internet connection. A few of these features are remote programming, remote firmware update, reporting to a monitoring station and certain notification options like e-mail sending. In case the SIM card has no mobile internet service the module can be programmed only through USB connection and it can send only SMS or call notification.

To use the internet service, you need to enter the SIM card's Access Point Name (APN) in the programming software. You can obtain the SIM card's public APN from your GSM provider. APN settings are explained in detail in section 4.1.1 of this manual.

The functions that use SMS sending need SMS service and the ones that use calls require GSM voice call service.

2.5.2 SIM card holder

To insert the SIM card remove the plastic cover of the device to access the SIM card case.

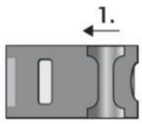

1. Pull the metal slider on the SIM card case towards the LED status light until you hear the click.

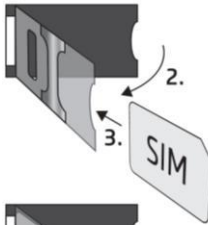

2. Lift the socket as shown.

3. Insert the SIM card into the socket with its interface down.

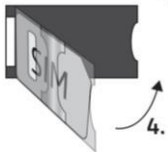

4-5. Fold down the socket and pull back the slider to its original position until you hear the click.

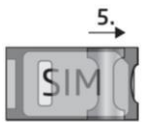

Finally replace the plastic cover.

2.6 Connecting the antenna



Attention! Do NOT connect the metallic parts of the GSM antenna connector directly or indirectly to the protective ground, because this may damage the module!

Connect the GSM antenna to the FME-M socket. The module comes with an antenna which provides good transmission under normal reception circumstances. In case of experiencing signal strength problems or/and wave interference (fading), use another (directed) type of antenna or find a more suitable mounting place for the antenna.

2.7 Installation environment

Before installing the module, verify the GSM signal strength with your mobile phone. It may happen that the signal strength is not sufficient in the desired mounting place. In this case the planned installation place can be changed before mounting the device.

Do not mount the unit:

- in places where it could be affected by strong electromagnetic disturbances (e.g. in the vicinity of electric motors, high voltage, etc.)
- in wet places or places with high degree of humidity

2.8 Putting into operation

- check the services provided by the SIM card (section 2.5.1)
- insert the SIM card into the module (section 2.5.2)
- connect the antenna (section 2.6)
- make the connection depending on the module version (section 2.4)
- connect the power supply (section 2.3)

2.9 LED signals

LED signal	Meaning
Yellow blinks	Bootng is in progress
Green blinks	Successfully connected to the GSM network
Green blinks fast	Successfully connected to the Internet
Continuous green with rare breaks	Successfully connected to the TELL server, normal operation
Green and red blink alternately	Alarm is in progress
Red blinks	GSM modem is starting
Continuous red	Firmware update is in progress

3. The programming software

The latest version of the programming software is downloadable from the manufacturer's website:

<http://tell.hu/en/products/gprs-communicators/pager-7>

Launch the installer and follow the instructions of Setup Wizard until the installation is complete.



3.1 User levels

The programming software has 2 user levels with different rights.

The admin has access to all settings and feature.

Both the admin and the user can freely configure the active desktop, have access to the module info and camera images. The dashboard settings belong to the device, so users can have different dashboards on each computer, tablet and mobile phone. They are allowed to record and review camera images, switch the relays, arm/disarm the partitions and cancel the alarm.

The default admin password is: 1111

The default user password is: 2222



Attention! After the first login be sure to change both the administrator and user password.

Both passwords can be modified in the 'Module settings' module which is described in detail in section 4.1.1 of this manual.

3.2 Logging into the programming software through USB connection

To program the device through USB follow these steps:

- launch the programming software
- connect the module to the computer via USB A-B cable
- on the programming software's login screen select the USB option
- enter the password and then click the 'Connect' button



Attention! Powering from USB is not sufficient for the full functionality, however it is enough for configuring the device!

The GSM network and the Internet access can only be assured if the proper power supply is connected. The requirements of the power supply are described in detail in section 2.3 of this manual.

3.3 Logging into the programming software through internet connection

To remote programming the device, mobile Internet connection is required and the module needs to be able to access the TELL cloud server. For this, first you need to set the SIM card's access point (APN), then the TELL server's address.

These settings can be found in section 4.1.1 of this manual.



Attention! Without setting up the access point and/or server data the device won't be available through the Internet!

To access the module remotely we need the module's hardware ID. This can be found on the „Module info” tab of the 'Module status' menu via USB connection.

HARDWARE ID:



To remote programming the device through the Internet follow these steps:

- launch the programming software
- on the programming software's login screen select the NET CONNECTION option and click the „Add new device” button
- name the device in the popup window and enter the hardware ID of the module and save it
- from the devices you have added, select which one you want to log in and enter the password in the popup window and press the "Login" button

4. Programming the module

4.1 The module

After login the customizable active dashboard is displayed. For more details on editing the active dashboard see 4.4 section of this manual. In the header, you can find the drop-down menu icon, the TELL logo, the time and date, the module's actual GSM signal strength, the supply voltage, the sign out icon and the language selector from the left to the right.

The TELL logo brings back to the dashboard from anywhere.

The time and date are automatically synchronized from the GSM network. If you want to manually synchronize them from the computer, you can do so in the 'Module settings' menu.

The signal strength in the header shows the module's actual GSM signal strength. Above 60% the GSM signal strength is sufficient, between 60-40% is low and below 40% is very low. If the signal strength does not reach 40%, it is recommended that you try to improve the signal strength as described in section 2.6.

For more information on power supply see section 2.3.

Each menu of the application has a built-in menu-specific help that can be accessed by clicking on the question mark next to the title at the top of the page. To get information about the given menu item click on the question mark icon.

 MODULE STATUS 

Help

4.1.1 Module settings

On the 'GSM settings' tab enter the PIN code to unlock the SIM card. In order to prevent the module from reaching the PUK code after entering multiple incorrect PIN codes, there's a built-in protection. The device tries a PIN code only once and as soon as no more PIN1 trial left, stops trying.

In the same section, you can enter the SIM card's phone number, the daily SMS limit and the SMS center number. SIM card providers may require the SMS center number for their SMS service.

GSM SETTINGS

PIN CODE	<input type="text" value="9439"/>
SELF CELL NUMBER	<input type="text" value="+36703054260"/>
DAILY SMS LIMIT	<input checked="" type="checkbox"/> Enable <input style="width: 40px; text-align: center;" type="text" value="2"/>
SMS CENTER NUMBER	<input type="text" value="+36309876543"/>
FORWARD ALL INCOMING SMS	<input type="checkbox"/> Adam (+9876543210) <input checked="" type="checkbox"/> John (+8765432109)

The device can also forward the incoming SMS messages. To use this feature, enter the desired phone number on the 'Phone numbers' page and then on the 'Module settings' page, select which phone numbers you want the incoming SMS messages to be forwarded to. For more details on setting up the phone numbers, see 4.5.1.

The SIM card's APN can be set in the 'Access point settings' section of the 'Connection settings' tab. You can obtain the SIM card's APN from your SIM card provider. In case the APN is not public you can also set the username and password in this section. It is important, that certain closed APNs do not allow to use the Internet freely, but provide access only to selected IP addresses. These closed APNs may block the use of features which require Internet access.



Attention! *If the access point settings are incorrect, the module's internet based services won't be available!*

The 'TELL Cloud settings' section is for setting up the server access. In default these fields are filled with the data of manufacturer's server reserved for this purpose, which are the followings:

Url: pager.devicemail.net

Port: 2018

If the name resolution doesn't work with your service provider replace the URL by the following IP address: 54.75.242.103



Attention! If the server settings are incorrect, certain services of the module won't be available!

On the 'Password' tab, you can change the password for both access levels (admin and user). Password length must be between 4 and 10 characters. To change a password, you need to enter the current admin password. To confirm the changes, click the 'Save' button.

GSM SETTINGS	CONNECTION SETTINGS	PASSWORD
DATE / TIME	INSTALLER SETTINGS	FIRMWARE UPGRADE

 ADMIN

ADMIN PASSWORD SETTINGS

ADMIN PASSWORD

PASSWORD AGAIN

CURRENT ADMIN PASSWORD

[Save](#)

 USER

USER PASSWORD SETTINGS

USER PASSWORD

PASSWORD AGAIN

CURRENT ADMIN PASSWORD

[Save](#)

On the 'Date/Time' tab the NTP server URL field allows you to specify the availability of a server that supports Network Time Protocol. If the device is able to request the time through the provided URL, this server will be used for synchronizing the date and time.

In the 'System time' section the system time can be refreshed manually.

The main notification address and the module's location can be added on the 'Installer settings' tab. Notifications on available firmware updates will be sent to the main notification address, which is usually the installer's e-mail address. If there's an available update, a notification link will appear in the notification email which link will start the firmware update. The device sends an email notification about the success of the update.

Here you can also specify the exact location of the device by selecting it on the map or entering the address. The coordinates will be automatically filled and stored during saving.

This helps the installer, so they can tell where the device is located even when they are remote accessing it.

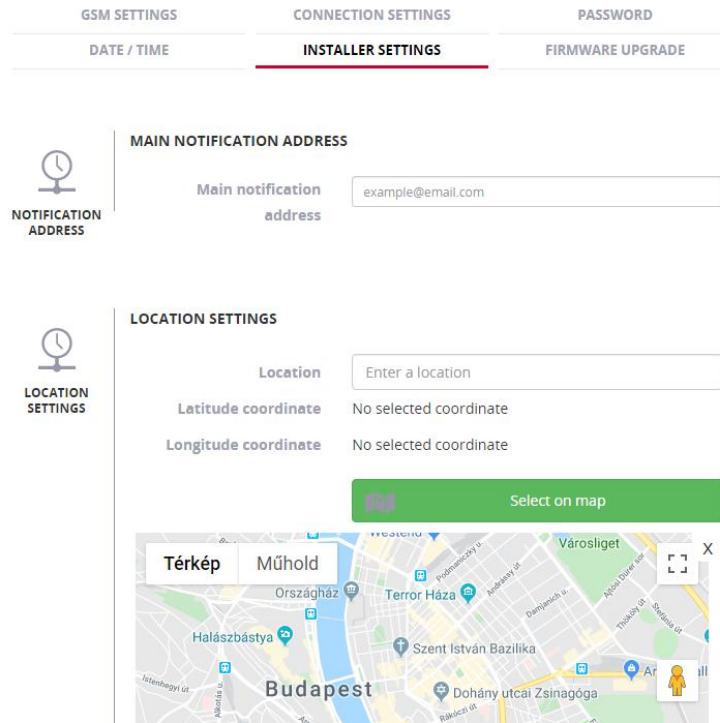

The device's firmware and bootloader can be refreshed on the 'Firmware upgrade' tab.

To manually update the Firmware, download the latest firmware file with bin extension from <https://tell.hu/en/products/gprs-communicators/pager-7> page.

Then 'Choose file' and click the 'Upload' button.

If the firmware is not compatible with the programming software a popup notification appears and if you are connected via USB, the automatic firmware update is also offered.

The bootloader upgrade should be done similarly to the firmware update. In the bootloader section, click the „Choose file” and „Upload” buttons to upload the bootloader file with bin extension you downloaded from the product page.

In the FOTA (Firmware Over the Air) URL field, you can enter the URL of the modem's firmware. The URL entered here will be sent to the device by the application and if the firmware for the GSM modem is available on the specified URL, the device downloads it and updates the modem.

The device can be restarted from this page with the „Device reboot” button or with the microswitch on the device. To do this, remove the SIM card cover and press the switch next to the SIM case for 2 seconds and release. The LED will start blinking red and the device will restart.

Factory settings can be reset by the „Factory reset” button on the „Firmware update” tab of the „Modul settings” menu or by using the microswitch on the device. To do this, remove the SIM card cover and press the switch next to the SIM case (see figure above) for 6 seconds, then release it. The LED will start blinking red and the device will restart after factory reset.

4.1.2 Module status

The page contains the most important information about the module. The dynamic wiring diagram is located at the top of the Input states page. With the icons, this provides an overview of the wires connected to the inputs even when the module is remotely accessed.



The 'Input states' section lists the inputs with their icon, name, type and state. This part is changing dynamically as soon as the status of any input is changing.

 Z1 - FRONT DOOR ZONE INPUT <hr/> NORMAL	 Z2 - GARAGE ZONE INPUT <hr/> EVENT
 S3 - KITCHEN SWITCH INPUT <hr/> ✓ ON	 Z4 - SWITCH ZONE INPUT <hr/> NORMAL

On the 'Relay states' tab the relays are listed with their icon, name and state. Like the input status, the status of the relay is also dynamically indicated by this page.

 R1 - SIREN <hr/> ✓ ON	 R1 - VENTILLATION <hr/> ⓪ OFF
---	---

The 'Status of the partitions' tab shows the name and armed/disarmed status of the partitions.

P1 - ALARM <hr/> ✓ ON	P2 - FIRE ALARM <hr/> ⓪ OFF
--------------------------	--------------------------------

The GSM signal strength, the module's date, time and the time zone are located on the 'Status of the connections' tab.

At the bottom of the page you can check whether the device is currently connected to the GSM network, the Internet, the TELL Cloud server and whether is a USB connection detected.

 USB <hr/> ✓ CONNECTED	 GSM OPERATOR <hr/> ✓ CONNECTED	 INTERNET <hr/> ✓ CONNECTED	 TELL CLOUD <hr/> ✓ CONNECTED
---	--	--	--

The status indicators are also dynamically changing.

The Module info' tab includes the device name, the device type and the hardware ID for remote access. Information on the firmware running on the device, information on the SIM card, the programming software's version and the GSM network related information are also in this section. You can also find a QR code here that contains the hardware ID to help you log on from your mobile device.

HARDWARE ID:



4.2 Inputs/outputs

Inputs, relays, zones and partitions can be configured in the 'Inputs/outputs' menu.

On the „Input settings” tab the dynamic wiring diagram is located at the top with the input icons set in the 'Input settings' section of this page.

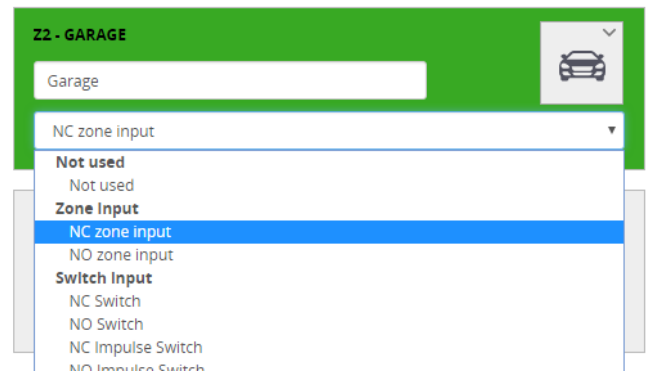
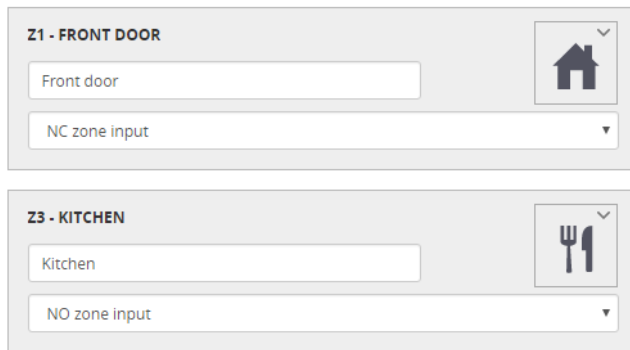

Input settings:

Enter the name of the input, then select its type and icon. Right after the icon is selected, the wiring diagram above shows the selected icon.

The input type can be zone, switch, impulse switch or temperature sensor. In case of zone, switch and impulse switch we can choose whether it is normally open (NO) or normally closed (NC). If you don't want to use an input, select the 'Not used' option from the drop down list.



 **Attention!** Do not leave unused inputs in NO or NC status as it may result false signals. However, if the type of the unused input remains NC, it is mandatory to close it for correct operation.

Each input has a prell delay setting that serves to filter out the disturbances on the input. The device considers only those contacts as events, which are longer, then the time specified here and the event-actions are executed in this case only.

Zone settings:

You can customize the inputs defined as zone in the 'Input settings' section and assign them to partitions (a group of zones). To use a zone, you need to enable it first. A disabled zone doesn't generate any events, so the signals coming from a zone can be blocked by disabling the zone. For example, in case of a possible failure, false signals coming from the zone can be eliminated by this setting.

 **Attention!** Zones need to be enabled in order to let the incoming contacts to generate event operations!

	NAME	ENABLED	PARTITION		24H	FOLLOW	FORCE	ENTRY DELAY		EXIT DELAY	
	Z1 - Front door	<input checked="" type="checkbox"/>	1 <input checked="" type="checkbox"/>	2 <input type="checkbox"/>	<input type="checkbox"/>	<input type="checkbox"/>	<input type="checkbox"/>	30	s	15	s
	Z2 - Garage	<input checked="" type="checkbox"/>	1 <input checked="" type="checkbox"/>	2 <input type="checkbox"/>	<input type="checkbox"/>	<input type="checkbox"/>	<input type="checkbox"/>	35	s	15	s
	Z4 - Switch	<input checked="" type="checkbox"/>	1 <input type="checkbox"/>	2 <input checked="" type="checkbox"/>	<input checked="" type="checkbox"/>	<input type="checkbox"/>	<input type="checkbox"/>	0	s	0	s

In the same field you can assign zones to partitions, as well as setting up the entry and exit delay times, the 24h, the follow and the force properties.

A 24h zone, irrespectively of arming and disarming the partitions, will always be armed.

The violation of a follow zone does not generate a zone event if it is preceded by the violation of a zone with entry delay within the same partition.

The active status of the non-force zone prevents those partitions from being armed to which it is assigned.

Under entry and exit delay times that period of time is meant, in which the system does not sign zone alarm in case of zone detection. This might be needed during arming (entry delay) and disarming (exit delay) of the system.

Output settings:

On the „Output settings” tab you can customize the 1 or 2 outputs depending on the device version. A relay can be bistable or monostable.

The output configured as bistable has two stable states: activated and deactivated. The bistable relay's output status is stable, meaning that it will not change until new control. Therefore, the delay cannot be set for a bistable relay.

If bistable mode is switched off, the relay will be monostable. The relay is normally open (NO), so it will be stable only in deactivated state. The monostable output becomes activated if an activation event occurs and remains activated for the time that is set in the 'Delay' field.

The output’s name and icon are also customizable. Right after the icon is selected, the wiring diagram above shows the selected icon.

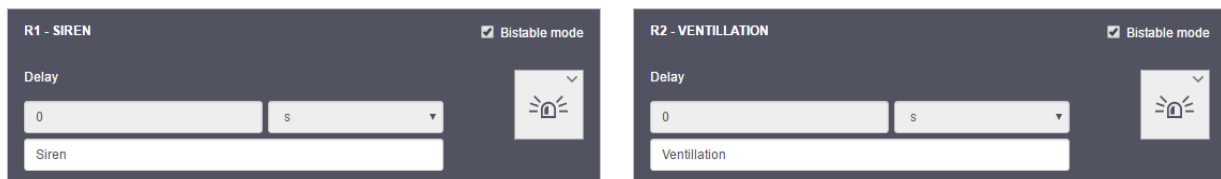

Changes can be saved with the "Save" button at the bottom of the page. To cancel the changes, you have made since the last save click the "Reset" button.

Modifications can be saved with help of the 'Save' button at the bottom of the page. To reject the modifications done since the last save click on the 'Reset' button.

Partition configurations:

On the „Partition settings” tab you can name partitions and configure whether the partition should be always armed. This can be done by choosing 'Always armed' options.



4.3 Cameras

One of the new functions of the device is that it is able to manage IP cameras, and can assign the cameras to zones. In case of an alarm in the given zone, the images of all the cameras previously associated with the zone are available in the application with a single click from the alarm popup window. At this time the zone violation could even be recorded, which provides an opportunity for later play-back.

4.3.1 Camera settings

New camera can be added by a click on 'Add camera' button. Here the name and the image URL of the camera picture planned to be used has to be entered.

In case you wish to enter the video URL of the IP camera too, it is possible in the Video URL field. This video stream, unlike snapshots will not be available within the application, but can be opened with an external player program.

The listed cameras can be sorted by assigning them to zones. A single camera might belong to more zones, and more cameras can be assigned to one zone. To save the modifications, click on the 'Save' button.

The module is able to store the settings of altogether 16 IP cameras. Deleting existing cameras is possible by clicking on the dust-bin icon.

4.3.1.1 IP Camera detect application

In case you possess an ONVIF camera and you wish to find out the link of such a camera, you can use our IP Camera detect application, which you can find at the bottom of the <https://tell.hu/en/products/gprs-communicators/pager-7> page among the downloadable softwares.

4.3.2 View cameras

This menu point serves to look through and prepare records from the cameras, added in point 4.3.1. You can filter the cameras based on zones. If you click on the 'Select all' button, you add all the cameras to the filtering conditions, while 'Select none' button clears the selection of each zone.

Since it is not compulsory to assign a camera to a zone, cameras, not assigned to zones are shown in the module if 'Cameras without zone' is selected.

You can start and stop recording by a click on 'Record' button in the own fields of certain cameras, or by clicking on the 'Recording all' button at the top right corner of the menu. In the previous case, only the pictures of the given camera will be recorded, while in the latter one, all camera pictures will be recorded.

By clicking on the 'Playback' button, you can play previous records, at this time the software navigates us to page 'Play records'.

4.3.3 Playing records menu point

It is possible to filter among records based on date. To play the records first the date has to be selected than the 'Play' button has to be pressed.

4.4 Configuring active dashboard

By clicking on the 'TELL' icon in the header or selecting the 'Dashboard' menu point the active dashboard can be reached anytime. The entire surface is active, which means that events and modifications are displayed real-time on the compiled dashboard.

Some of the widgets placed on desktop are interactive. It is possible to control relays by clicking on the widget, or change the armed status of partitions.

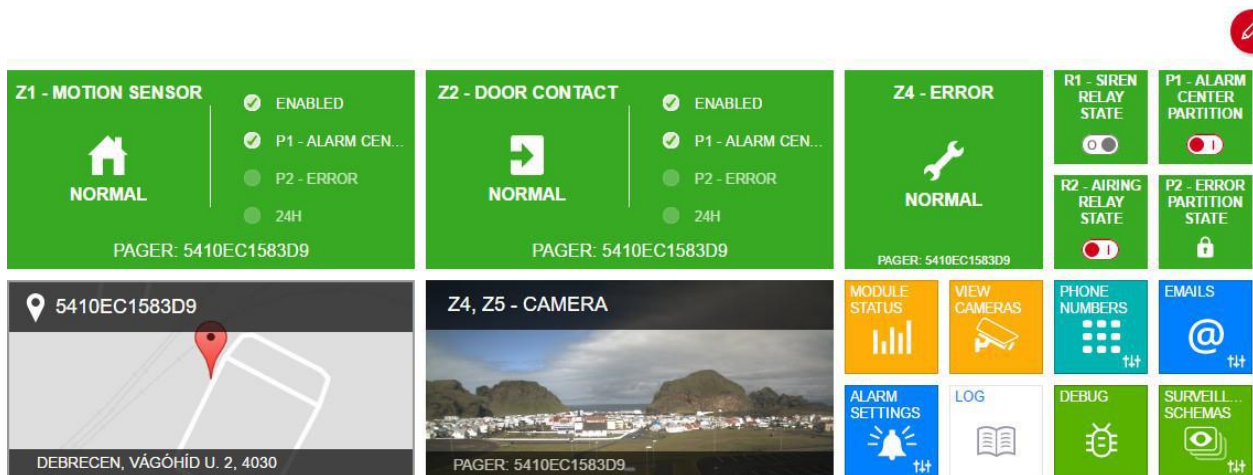

4.4.1 Adding widgets

You can customize the desktop with help of the red edit button in the top right corner. By clicking on any empty square, the widget selector opens, and the top left corner of the chosen widget will be placed in the previously chosen square. In the widget selector menu, you can choose from many widgets in four different sizes. The size of the widget indicates how many squares will be taken on the desktop by that certain widget.

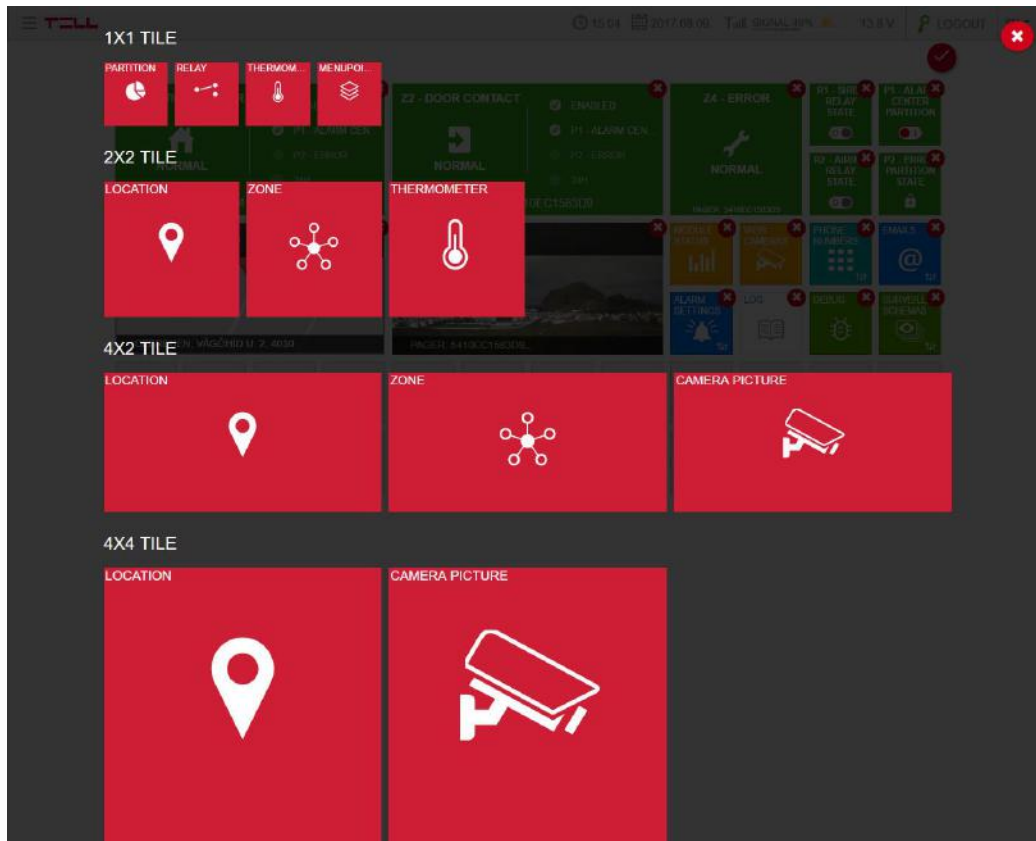

1x1 widgets to add:

- **Partition:** The partition, required to be added as widget has to be selected here. The added widget is interactive – it can be armed and disarmed by a click, and shows always the actual status of the partition. In case of an 'Always armed' partition a lock icon will be displayed on the widget, instead of a switch, and the system will not allow to disarm the given partition.
- **Relay:** The relay, required to be added has to be selected here. The added widget is interactive – it can be closed/opened by a click.
- **Temperature sensor:** The temperature sensor, required to be added has to be selected here.
- **Menu point:** A frequently used menu point can be selected here and added directly to the dashboard.

2x2 widgets to add:

- **Place:** This shows the place of the module, as given in 'Module settings' menu point.
- **Zone:** The zone, required to be added as widget has to be selected here. The events, occurring on that zone will be displayed on the widget as well.
- **Temperature sensor:** The temperature sensor, required to be added has to be selected here.

4x2 widgets to add:

- **Place:** This shows the place of the module, as given in 'Module settings' menu point.
- **Zone:** The zone, required to be added as widget has to be selected here. The events, occurring on that zone will be displayed on the widget as well, while on the right side of the widget, the important information of the zone will be presented.
- **Camera picture:** The picture of an already added camera has to be selected here.

4x4 widgets to add:

- **Place:** This shows the place of the module, as given in 'Module settings' menu point.
- **Camera picture:** The picture of an already added camera has to be selected here.

4.5 Notification settings

The device is able to send notifications in several ways about the events generated on the module. There is an option for playing voice messages via calls, sending SMS and emails. To register these notifications channels, the following menu points can be used:

4.5.1 Phone numbers menu point

You can choose from among the here listed phone numbers in 'Event Settings' menu point, if you want to assign SMS sending or phone call operations to events. It is also possible to control the module via call with DTMF commands – the module accepts DTMF commands only from those phone numbers, which we have previously recorded.

The module can manage altogether 8 phone numbers.

The screenshot displays two configuration cards for phone numbers. The first card, titled 'Test installer', has a trash icon in the top right corner. It contains the following fields: Name (Test installer), Phone number (+36301234567), Password not required (checked), Password (12345678), and Permissions (checked for 'ACK on call success or hang up' and 'Stop other operations'). The second card, titled 'Test user', also has a trash icon. It contains: Name (Test user), Phone number (+36307654321), Password not required (unchecked), Password (12345678), and Permissions (checked for 'ACK on call success or hang up' and 'Stop other operations'). Below these cards is a yellow dashed box containing a plus sign and the text 'ADD PHONE NUMBER'. At the bottom right of the form is a red 'Save' button.

Password not required: If you choose this option, calls from that given phone numbers will be automatically authorized for control, these can control without password, via DTMF commands.

Password: This password will be required in case of incoming calls for DTMF control, if 'No password needed' is not ticked in.

ACK on call success or hang up: If this option is ticked in, the incoming notification calls will be automatically acknowledged, either the call has been accepted or rejected.

Stop other operations: In case of a call comes in as a notification to this number, the called party can stop further operations via DTMF command, which normally would be executed. E.g. if it is set by an event, that the module initiates call for more phone numbers, if you tick this option in, the first number which receives the call can stop operations, therefore no calls will be given on the further numbers.

About the applicable DTMF commands and operation of programming via calls we give further information in point 5.1.

4.5.2 Text templates menu point

In this menu point, you can enter the texts of e-mails, SMS and PUSH notifications, which will be sent as notifications. These schemes can be applied in 'Event settings' menu point by SMS, PUSH and e-mail sending operations.

E-mail text can be entered by giving the subject and the body of the e-mail. In case of SMS and PUSH notifications, only the text should be typed in.

You can add up to 16 email text templates, 16 PUSH text templates and 12 SMS text templates.

4.5.3 Emails menu point

To add a new e-mail address, the e-mail address and the belonging name has to be entered. You can choose from among the here listed e-mail addresses in the 'Event settings' menu point, if you would like to assign e-mail sending notification to an event.

Altogether 8 e-mail addresses can be entered into the module.

4.5.4 Sounds menu point

You can choose from among the sounds uploaded here in the 'Event settings' menu point, if you would like to assign phone call operation to an event.



Attention! Uploading sounds is possible via USB connection, only!

Altogether 8 different sound files can be uploaded to the module. You can find 3, predefined sound files in the application, if needed these can be used. Each sound file can be named. You can upload the sounds with 'Upload' or 'Upload All' buttons from the application to the module.

In case you wish to upload an own sound file, check if it meets the requirements below:

- 8Khz, Mono,16 Bit PCM
- maximum length 8 seconds
- wav format

You can save changes by clicking on the 'Save' button at the bottom of the table. You can play the predefined notification tones by clicking on the 'Play' buttons at the bottom of the page.

4.5.5 Push notifications

In this menu, you can see the mobile devices which have ever been logged onto the module, in case of receiving push notification was enabled by opening the application. You can edit the name of the listed devices and you can also remove a device from the list. You can choose from among the devices listed here, in the 'Event settings' menu point, if you would like to assign push message sending to an event.

4.6 Alarm settings menu point

You can find the settings of the alarm event in this menu point, which can be assigned to events, as event-action in 'Event settings' menu point.

Max Alarm Time	<input type="text" value="10"/>	m	Maximum number of alarms per zone	<input type="text" value="11"/>
Restriction time	<input type="text" value="12"/>	h		

With the max alarm time, you can set the time period, under which the module stays in alarmed status from the supervision of alarm. From alarmed status, by the time the module will stay automatically back to normal status. You can assign arbitrary actions to the change of armed status.

You can set up a restriction, regarding how many alarm event can be maximally caused in case of zone violation. The period of restriction can be set in hours and minutes.

Changes can be saved with the 'Save' button at the bottom of the page.

4.7 Signalling to monitoring station

The device is able to signal customizable Contact ID codes due to certain events towards one or more remote monitoring servers. These signals can be assigned to events in 'Event settings' menu point.

For the transmission towards monitoring station, the remote monitoring servers have to be configured and ordered into schemes.

4.7.1 Surveillance settings menu point

The module is able to manage two types of remote monitoring protocol, these are TELLMON and SIA protocols.

To add a new remote monitoring station, the name of it can be freely chosen, however further data necessary for configuration can be provided by the remote monitoring station.

Surveillance 1 			
Name	<input type="text" value="Surveillance 1"/>	Keep alive frequency	<input type="text" value="1"/> <input type="text" value="m"/>
Type	<input type="text" value="TELLMON"/>	Customer URL	<input type="text" value="192.168.9.425"/>
Client ID	<input type="text" value="5123"/>	Protocol	<input type="text" value="TCP"/>
Group ID	<input type="text"/>	Port	<input type="text" value="4444"/>

Parameters have to be fulfilled in case of TELLMON and SIA protocol as well:

Keep alive frequency:

By entering the keep alive frequency, you can configure the frequency of status reports sent towards the remote monitoring server. This number needs to be synchronized with the receiver of the remote monitoring station.

URL:

Here you can enter the URL of the remote monitoring server.

Protocol:

Determined by the remote monitoring station, too whether it uses TCP or UDP protocol.

Port:

The module communicates with the remote monitoring server via this port.

Parameters, which need to be filled in only in case of TELLMON protocol:

Client ID:

A four-character-long identifier, which is used by the remote monitoring station to identify users. It can contain numbers and A, B, C, D, E and F letters.

Group ID:

In case of the remote monitoring station requires, a secondary Client ID needs to be given for client identification. The minimal length of this identifier is 3, the maximal is 16 characters.

Parameters, which need to be filled in only in case of SIA protocol:

CID Client ID:

A four-character-long identifier, which is used by the remote monitoring station to identify users. It can contain numbers and A, B, C, D, E and F letters.

SIA Client ID:

In case of the remote monitoring station requires, a secondary Client ID needs to be given for client identification. The minimal length of this identifier is 3, the maximal is 16 characters.

Receiver number:

This is an optional field, which server as receiver identifier at the remote monitoring station. Its maximal length is 6 hexa characters.

Account prefix:

This field serves for entering the maximum 6 hexa characters long prefix of the client identifier.

Encryption key:

If the remote monitoring station's server is using encrypted communication, the required key has to be entered into this field. The length of the key can be 16, 32 or 64 characters.

Changes can be saved with help of 'Save' button at the bottom of the page.

Surveillance 1 			
Name	<input type="text" value="Surveillance 1"/>	Encryption key	<input type="text"/>
Type	<input type="text" value="SIA"/>	Keep alive frequency	<input type="text" value="1"/> <input type="text" value="m"/>
CID Client ID	<input type="text" value="5123"/>	Customer URL	<input type="text" value="192.168.9.425"/>
SIA Client ID	<input type="text"/>	Protocol	<input type="text" value="TCP"/>
Receiver number	<input type="text"/>	Port	<input type="text" value="4444"/>
Account prefix	<input type="text"/>		

4.7.2 Surveillance schemas

From the remote monitoring servers, entered in point 4.7.1 you have to create schemas in order to make the module able to execute 'Report action via net' action and throughout Contact ID transmission. Maximum 6 schemas can be created this way.

You can list maximum 6 servers in one schema. These servers are in their basic status primary servers; you can change their status to backup by ticking in the 'Server is backup' option.

When you want to use the server schema for signalling, the device attempts to transmit the Contact ID code, entered into 'Report action via net' action, to each primary servers. In case of unsuccessful connection with the primary servers, it goes through the backup servers, but in this case, stops after the first successful signal, does not attempt to reach the other backup servers.

The screenshot displays two configuration panels. The top panel, titled 'Value protection', contains two server slots. 'Server 1' is configured with 'Remote monitoring' and 'Server is backup' is unchecked. 'Server 2' is configured with 'Backup remote monitoring' and 'Server is backup' is checked. Below these is a '+ ADD SERVER' button. The bottom panel, titled 'Service', contains one server slot 'Server 1' with 'Troubleshooting' and 'Server is backup' unchecked. To its right is a '+ ADD SERVER' button. At the bottom of the 'Service' panel is a '+ ADD SCHEMA' button. A red 'Save' button is located at the bottom right of the interface.

If you contracted with two or more remote monitoring companies, it is worth to configure separate remote monitoring server schemas for each of them, with their own backup servers, throughout ensuring the arrival of signal.

4.8 Event settings

You can assign actions to be fulfilled to forthcoming events on the module in this menu point.

4.8.1 Events

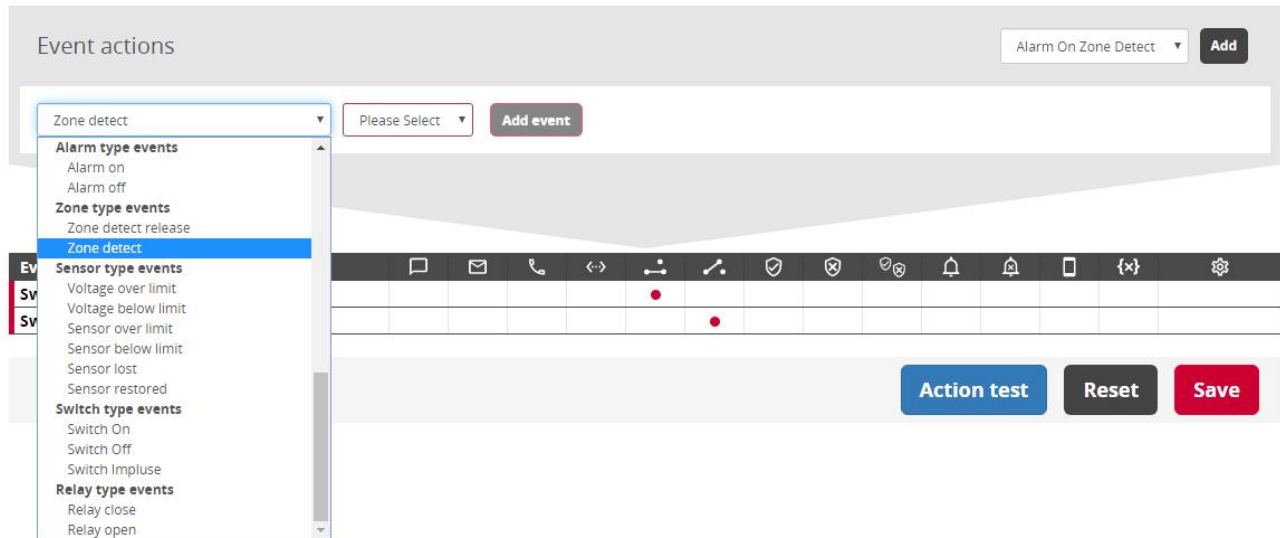

Events can be listed in the following event-types:

System type events:

- **Device on:** Actions, assigned to this event will be fulfilled by switching on the device.
- **GSM connect:** Actions, assigned to this event will be fulfilled by successful connection to the GSM network. The restore-event pair of this event is 'GSM disconnect'.
- **GSM disconnect:** Actions, assigned to this event will be fulfilled by GSM network connection break. The restore-event pair of this event is 'GSM connect'.
- **SERVER connect:** Actions, assigned to this event will be fulfilled by successful connection to TELL cloud server. The restore-event pair of this event is 'SERVER disconnect'.
- **SERVER disconnect:** Actions, assigned to this event will be fulfilled by TELL cloud server connection break. The restore-event pair of this event is 'SERVER connect'.
- **Net connect:** Actions, assigned to this event will be fulfilled by successful connection to the internet. The restore-event pair of this event is 'Net disconnect'.
- **Net disconnect:** Actions, assigned to this event will be fulfilled by internet connection break. The restore-event pair of this event is 'Net connect'.
- **USB connect:** Actions, assigned to this event will be fulfilled by USB connection to the module. The restore-event pair of this event is 'USB disconnect'.
- **USB disconnect:** Actions, assigned to this event will be fulfilled by USB disconnection. The restore-event pair of this event is 'USB connect'.

- **Test action:** Actions, assigned to this event will be fulfilled by clicking on 'Test Action' button in 'Event settings' menu. This is a useful tool to test the various event actions.
- **Operation mode changed:** The device is able to fulfill operations depending on the status of the supply voltage on it. By adding the operation, it can be selected whether the module should fulfill the operations, assigned to events in case of USB-, or normal supply (12-30 V DC).
- **DTMF command:** Actions, assigned to this event will be fulfilled in case of incoming DTMF command. The list of DTMF commands, managed by the module can be found in point 5.1 of the manual.
- **SMS command:** Actions, assigned to this event will be fulfilled by incoming SMS command. The list of SMS commands, managed by the module can be found in point 5.2 of the manual.
- **Incoming call from unknown number:** Actions, assigned to this event will be fulfilled in case of incoming call from unknown number.
- **Incoming call from trusted number:** Actions, belonging to this event will be fulfilled in case of incoming call from the given phone number. Trusted covers the numbers, added previously in 'Phone numbers' menu point.
- **Config segment modified:** Actions, assigned to this event will be fulfilled by changing module settings.
- **Scheduled action:** Actions, assigned to this event will be fulfilled at a previously defined date. Date can be entered by choosing the event.
- **Time changed:** Actions, assigned to this event will be fulfilled by system time change.
- **Repeating action:** Actions, assigned to this event will be repeated by the here defined frequency.
- **Password change:** Actions, assigned to this event will be fulfilled by admin or user password change.
- **SIM card removed:** Actions, assigned to this event will be fulfilled in case the SIM card is removed from the device.
- **SIM card ready:** Actions, assigned to this event will be fulfilled in case a SIM card is inserted into the device.
- **Modem firmware upgrade success:** Actions assigned to this event will be fulfilled by successful firmware upgrade.
- **Modem firmware upgrade failed:** Actions, assigned to this event will be fulfilled in case the firmware upgrade failed.

Partition type events:

- **Partition arm:** Actions, assigned to this event will be fulfilled by partition arming. The partition can be chosen by adding the event. The restore-event pair of this event is 'Partition disarm'.
- **Partition disarm:** Actions, assigned to this event will be fulfilled by partition disarming. The partition can be chosen by adding the event. The restore-event pair of this event is 'Partition arm'.

Alarm type events:

- **Alarm on:** Actions, assigned to this event will be fulfilled by switching the alarm on. The restore-event pair of this event is 'Alarm off'.
- **Alarm off:** Actions, assigned to this event will be fulfilled by switching the alarm off. The restore-event pair of this event is 'Alarm switch on'.

Zone type events:

- **Zone detect:** Actions, assigned to this event will be fulfilled by zone breach. The zone can be selected by adding the event. The restore-event pair of this event is 'Zone detect release'.
- **Zone detect release:** Actions, assigned to this event will be fulfilled by zone breach ceasing. The zone can be selected by adding the event. The restore-event pair of this event is 'Zone detect'.

Sensor type events:

- **Voltage limit over:** Actions, assigned to this event will be fulfilled by supply voltage raising above a certain threshold limit. Threshold limit can be entered by adding the event. The restore-event pair of this event is 'Voltage limit under'.
- **Voltage limit under:** Actions, assigned to this event will be fulfilled by supply voltage decrease under a certain threshold limit. Threshold limit can be entered by adding the event. The restore-event pair of this event is 'Voltage limit over'.
- **Sensor limit over:** Actions, assigned to this event will be fulfilled by temperature raising above a certain threshold limit. Temperature sensor and threshold limit can be chosen by adding the event. The restore-event pair of this event is 'Sensor limit under'.
- **Sensor limit under:** Actions, assigned to this event will be fulfilled by temperature decrease under a certain threshold limit. Temperature sensor and threshold limit can be chosen by adding the event. The restore-event pair of this event is 'Sensor limit over'.
- **Sensor lost:** Actions, assigned to this event will be fulfilled by ceasing temperature sensor signals. The temperature sensor can be chosen by adding the event. The restore-event pair of this event is 'Sensor restored'.
- **Sensor restored:** Actions, assigned to this event will be fulfilled by restoring temperature sensor signals. The temperature sensor can be chosen by adding the event. The restore-event pair of this event is 'Sensor lost'.

Switch type events:

- **Switch On:** Actions, assigned to this event will be fulfilled by switching contact on. From among the contact type inputs you can choose by adding the event. The restore-event pair of this event is 'Switch off'.
- **Switch Off:** Actions, assigned to this event will be fulfilled by switching contact off. From among the contact type inputs you can choose by adding the event. The restore-event pair of this event is 'Switch on'.
- **Switch Impulse:** Actions, assigned to this event will be fulfilled by incoming impulse via impulse type inputs. You can choose from among the impulse switch type inputs by adding the event.

Relay type events:

- **Relay close:** Actions, assigned to this event will be fulfilled by relay tightening. The relay can be chosen by adding the event. The restore-event pair of this event is 'Relay open'.
- **Relay open:** Actions, assigned to this event will be fulfilled by relay loosing. The relay can be chosen by adding the event. The restore-event pair of this event is 'Relay close'.

Register type events:

- **Register value equals:** Actions, assigned to this event are performed when the selected register takes the value specified here.
- **Register value over limit:** Actions, assigned to this event are performed when the value of the selected register exceeds the value specified here.
- **Register value under limit:** Actions, assigned to this event are performed when the value of the selected register is less than the value specified here.
- **Register bitwise AND:**

4.8.2 Actions

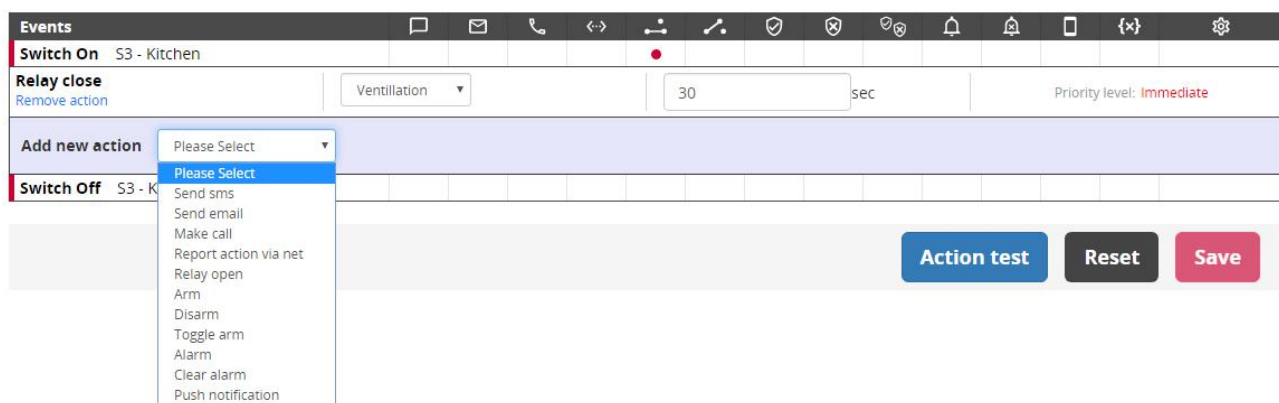

You can assign any number of the following actions to the chosen events in point 4.8. The system is able to manage altogether 100 event-action pairs:

Send SMS:

You can send in 'Text templates' menu point predefined texts in SMS to one of the phone numbers, added to 'Phone numbers' menu point. You can also add new text or phone number by operation settings, with a click on the appropriate button. These phone numbers and texts will be saved automatically, and will be available later in 'Phone numbers' and 'Text templates' menus.

Send email:

You can send a predefined text in e-mail, as set in 'Text templates' menu to one of the e-mail addresses, entered into 'Emails' menu point. You can also add new text or e-mail address by clicking on the appropriate button. These e-mail addresses and texts will be saved automatically, and will be available later in 'Emails' and 'Text templates' menus.

Make call:

You can send a tone file set in 'Sounds' menu to one of those phone numbers, entered in 'Phone numbers' menu point. In this case phone call plays a tone file. You can add new phone numbers by clicking on the appropriate button, when setting up the operation. These numbers will be saved automatically, and will be available later in 'Phone numbers' menu.

Report action via net:

The module is able to send Contact ID based alert to one of the schemes added into 'Surveillance schemas'. Leaving the Contact ID field blank will send the default code assigned to the event. However, we have the opportunity to override this. In this case, a 4-digit CID must be entered, the first digit being 1 for a new event and 3 for a reset event. You can also click on the magnifying glass icon and filter by name or code to find the proper code.

Relay close:

This action closes the selected relay. By adding the action, you have to choose the relay or relays, wished to get closed. The opposite of this action is 'Relay open' action.

Relay open:

This action opens the selected relay. By adding the action, you have to choose the relay or relays, wished to get opened. The opposite of this action is 'Relay close' action.

Arm:

The action arms the chosen partition. By adding the operation, you have to choose the partition or partitions, wished to get armed. The opposite of this action is 'Disarming' action.

Disarm:

The action disarms the chosen partition. By adding the action, you have to choose the partition or partitions, wished to get disarmed. The opposite of this action is 'Arming' action.

Toggle arm:

Depending on the status of the partition or partitions, the module fulfills arming or disarming action. By adding the action, the partition or partitions have to be chosen, which are requested to get armed or disarmed.

Alarm:

The action starts the alarm. The opposite of this action is 'Stopping alarm'.

Clear alarm:

The action stops the alarm. The opposite of this operation is 'Alarm'.

Push notification:

You can send Push message to one of the mobile devices, listed in 'Push notifications' menu point. The message can be selected from the texts added in 'Text templates' menu or you can also add new text by clicking on the 'Add' button.

Operation priority:

You can assign more actions to one event, which will be fulfilled as per priority level. The order of the same priority actions can be changed after the first adding and saving of the event. The 'Immediate' priority actions will be fulfilled out of turn, while 'High' and 'Low' priority actions will be listed among the actions, waiting for fulfilment, and will be fulfilled according to their priority.

High priority actions are usually the ones which require GSM network, but can be fulfilled quickly, while the time-consuming actions have lower priority (e.g.: a phone call).

4.8.3 Presets

The predefined event-action schemas help by adding frequently used events and their actions. This is for instance 'Report zone detects' and 'Alarm on zone detect' presets.

The screenshot displays the 'Event actions' configuration screen. At the top, there's a header 'Event actions' and an 'Add' button. Below it, a dropdown menu is open, showing 'Alarm On Zone Detect' as the selected option, with other options being 'Select Preset', 'Report Zone detects', and 'Alarm On Zone Detect'. The main form area contains two dropdown menus: 'Switch Off' and 'Kitchen', followed by an 'Add event' button. Below the form is a table titled 'Events' with three rows of zone detect events. At the bottom of the screen, there are three buttons: 'Action test', 'Reset', and 'Save'.

Events																		
Zone detect	Z1 - Front door																	
Zone detect	Z2 - Garage																	
Zone detect	Z4 - Switch																	

4.9 Log, configuration and debug

4.9.1 Log menu point

The events occurred on the module are displayed in a tabular form. The module is able to store 1000 events altogether. In case of the number of events would increase above 1000, the oldest events will be replaced. In the chart you can find information about the time when the event occurred, its name, two parameters and the fulfilment status of the actions. In the event parameters you can find for example the input and relay IDs, sensor data and information regarding module status.

With help of the arrows, at the top of the chart you can switch among the pages, jump to the beginning or the end of the log. By typing in the number of the required page into the field

between the arrows, you can jump to the given page. By clicking on the button at the top right corner of the chart you can reload the list.

#	Date / time	Event name	Parameter 1	Parameter 2	Actions
1	2017-08-09 13:32:03	Config segment modified			Completed
No event actions					
2	2017-08-09 13:31:52	Config segment modified			Completed
3	2017-08-09 13:31:45	Partition disarm	Partition: P1 - Partióció 1		Completed
4	2017-08-09 13:31:44	Partition arm	Partition: P1 - Partióció 1		Completed

You can get information about the operations, belonging to the events with help of the downward arrow next to the serial number of the events.

4.9.2 Configuration menu point

You have more options regarding the configuration saving. Every element of the configuration will be saved by default, however by clicking on the arrow next to 'Select all' caption, the configuration to be saved can be customized by choosing its various elements. You can save the configuration by clicking on 'Save' button after entering a filename.

Load configuration file

Choose file 

```
emails[2].subject="Pager7 sensor error"
emails[2].id=2
[emails]
emails[1].uid=224
emails[1].name="installer e-mail"
emails[1].emailaddress="installer@tell.hu"
emails[1].id=1
emails[2].uid=228
emails[2].name="user e-mail"
```

An already existing configuration can be loaded also from file, this time you have to choose the appropriate configuration file from computer, then click on 'Load' button. As an extra function, you can modify the chosen configuration before loading, by clicking on the edit icon.



Attention! This function requires competence and high expertise!

4.9.3 Debug information

The chart, containing the time, category and parameters of debug information can be reached in 'Debug information' menu point. This menu point is mostly useful by troubleshooting, and with help of this you can have exact information about the operation of the module. By switching on and off the criteria above the chart you can filter data. This way filtered data can be saved in CSV format on computer, by clicking on 'Export debug information' button.

5. Alternative programming options

A small proportion of programming the module can be done without internet connection or application, via GSM call, DTMF commands. Besides this, with DTMF commands you have an option for certain module status query, acknowledgement of outgoing calls, pausing operations after call notifications.



Attention! *These functions are available only, if the SIM card in the module supports making and answering calls.*

5.1 DTMF commands

DTMF commands in case of incoming calls:

- *9PWD# Module password entering for authentication. 'PWD' has to be replaced with the password.
- *0P# Partition disarming. 'P' has to be replaced with the number of partition wished to be disarmed (e.g.: *01#).
- *1P# Partition arming. 'P' has to be replaced with the number of partition wished to be armed (e.g.: *12#).
- *2P# Partition status query. 'P' has to be replaced with the number of partition (e.g.: *21#).
- *3RS# Relay status setup. 'R' has to be replaced with the number of the relay wished to be controlled, while 'S' has to be replaced with 1 if you want to close, 0 if you want to open the relay (e.g. *321#).
- *3R# Relay status query. 'R' has to be replaced with the number of the relay wanted to have a query on.(e.g.: *31#).

DTMF command in case of outgoing calls:

- * Phone notification acknowledgement.
- # Stopping further operations. If you stop the operation with this command, the further phone numbers set up will not be called by the module.

The module gives feedback through the line about the successful fulfilment of the commands, and answers status query this way, too. The meaning of three short beep after giving out the command is 'successful operation', while in case of status query, 'switched on status'. The meaning of a long beep after giving out the command is 'unsuccessful operation', in case of status query, 'switched off status'.

5.2 SMS commands

Command in case of incoming SMS:

*PWD=jelszó#	Module password entering for authentication. 'PWD' has to be replaced with the password, added by entering a phone number.
*HWID#	Hardware ID query from module.
*APN=NAME,[USER],[PASSWORD]#	Setting up the module APN. 'NAME' has to be replaced with access point name, while 'USER' and 'PASSWORD' has to be replaced with the user name and password belonging to that access point (e.g.: *APN=internet,[installer],[appletree]#). User and password are optional, in case of public APN, it is not necessary to be entered.
*PX=0#	Partition disarming. 'X' has to be replaced with the number of partition, wished to be disarmed (e.g.: *P1=0#).
*PX=1#	Partition arming. 'X' has to be replaced with the number of partition, wished to be armed (e.g.: *P2=1#).
*RX=Y#	Relay status setting in bistabil mode. 'X' has to be replaced with the number of the relay, wished to be controlled, while 'Y' has to be replaced with 1 if you wish to close and 0 if you wish to open the relay (e.g.: *R1=1#).
*RX=1Z#	Relay status setting in monostabil mode. 'X' has to be replaced with the number of the relay, wished to be controlled, while 'Z' has to be filled up with the amount and unit of time, for which time the relay must stay closed. The unit can be second (s), minute (m) or hour (h). If the unit is not specified, it will be second in default (e.g.: *R1=130#).
*STATUS#	Status report query from module. You will receive a similar list in a reply SMS: STATUS: U=12.21; S=-72dBm (56%); P1: 1; P2: 0; Z1: 1; Z2: 1; T3: 25; I4: N/A; R1: 1; R2: 0; TIME (UTC): 2017-01-01 12:00:00; Here, U is voltage, S is field strength, P1-P2 are partitions, Z1-Z2 are zone-defined inputs, T3 is a temperature sensor input, I4 is an undefined input, R1-R2 show relay status. Besides this, the module time can be read as well.
*REBOOT#	Module reboot.
*XXX, CRQ#	Rely SMS query about the fulfilment of the above command. 'XXX' has to be replaced with that command, about which you want to receive the reply SMS (e.g.: *R1=1, CRQ#).

You can send more commands in one SMS, these commands have to be written without space in an SMS after each other, * and # have separating function, framing the command.



www.tell.hu

Document version: 2.1 – 30.03.2022