



# **Wireless Bridge**

**Quick Start Guide**

## Legal Information

©2021 Hangzhou Hikvision Digital Technology Co., Ltd. All rights reserved.

### About this Manual

The Manual includes instructions for using and managing the Product. Pictures, charts, images and all other information hereinafter are for description and explanation only. The information contained in the Manual is subject to change, without notice, due to firmware updates or other reasons. Please find the latest version of this Manual at the Hikvision website ( <https://www.hikvision.com/> ).

Please use this Manual with the guidance and assistance of professionals trained in supporting the Product.

### Trademarks

**HIKVISION** and other Hikvision's trademarks and logos are the properties of Hikvision in various jurisdictions.

Other trademarks and logos mentioned are the properties of their respective owners.

### Disclaimer

TO THE MAXIMUM EXTENT PERMITTED BY APPLICABLE LAW, THIS MANUAL AND THE PRODUCT DESCRIBED, WITH ITS HARDWARE, SOFTWARE AND FIRMWARE, ARE PROVIDED "AS IS" AND "WITH ALL FAULTS AND ERRORS". HIKVISION MAKES NO WARRANTIES, EXPRESS OR IMPLIED, INCLUDING WITHOUT LIMITATION, MERCHANTABILITY, SATISFACTORY QUALITY, OR FITNESS FOR A PARTICULAR PURPOSE. THE USE OF THE PRODUCT BY YOU IS AT YOUR OWN RISK. IN NO EVENT WILL HIKVISION BE LIABLE TO YOU FOR ANY SPECIAL, CONSEQUENTIAL, INCIDENTAL, OR INDIRECT DAMAGES, INCLUDING, AMONG OTHERS, DAMAGES FOR LOSS OF BUSINESS PROFITS, BUSINESS INTERRUPTION, OR LOSS OF DATA, CORRUPTION OF SYSTEMS, OR LOSS OF DOCUMENTATION, WHETHER BASED ON BREACH OF CONTRACT, TORT (INCLUDING NEGLIGENCE), PRODUCT LIABILITY, OR OTHERWISE, IN CONNECTION WITH THE USE OF THE PRODUCT, EVEN IF HIKVISION HAS BEEN ADVISED OF THE POSSIBILITY OF SUCH DAMAGES OR LOSS.

YOU ACKNOWLEDGE THAT THE NATURE OF THE INTERNET PROVIDES FOR INHERENT SECURITY RISKS, AND HIKVISION SHALL NOT TAKE ANY RESPONSIBILITIES FOR ABNORMAL OPERATION, PRIVACY LEAKAGE OR OTHER DAMAGES RESULTING FROM CYBER-ATTACK, HACKER ATTACK, VIRUS INFECTION, OR OTHER INTERNET SECURITY RISKS; HOWEVER, HIKVISION WILL PROVIDE TIMELY TECHNICAL SUPPORT IF REQUIRED.

YOU AGREE TO USE THIS PRODUCT IN COMPLIANCE WITH ALL APPLICABLE LAWS, AND YOU ARE SOLELY RESPONSIBLE FOR ENSURING THAT YOUR USE CONFORMS TO THE APPLICABLE LAW. ESPECIALLY, YOU ARE RESPONSIBLE, FOR USING THIS PRODUCT IN A MANNER THAT DOES NOT INFRINGE ON THE RIGHTS OF THIRD PARTIES, INCLUDING WITHOUT LIMITATION, RIGHTS OF PUBLICITY, INTELLECTUAL PROPERTY RIGHTS, OR DATA PROTECTION AND OTHER PRIVACY RIGHTS. YOU SHALL NOT USE THIS PRODUCT FOR ANY PROHIBITED END-USES, INCLUDING THE

## Wireless Bridge Quick Start Guide

---

DEVELOPMENT OR PRODUCTION OF WEAPONS OF MASS DESTRUCTION, THE DEVELOPMENT OR PRODUCTION OF CHEMICAL OR BIOLOGICAL WEAPONS, ANY ACTIVITIES IN THE CONTEXT RELATED TO ANY NUCLEAR EXPLOSIVE OR UNSAFE NUCLEAR FUEL-CYCLE, OR IN SUPPORT OF HUMAN RIGHTS ABUSES.

IN THE EVENT OF ANY CONFLICTS BETWEEN THIS MANUAL AND THE APPLICABLE LAW, THE LATER PREVAILS.

## Regulatory Information

### FCC Information

Please take attention that changes or modification not expressly approved by the party responsible for compliance could void the user's authority to operate the equipment.

FCC compliance: This equipment has been tested and found to comply with the limits for a Class A digital device, pursuant to part 15 of the FCC Rules. These limits are designed to provide reasonable protection against harmful interference in a residential installation. This equipment generates, uses and can radiate radio frequency energy and, if not installed and used in accordance with the instructions, may cause harmful interference to radio communications. However, there is no guarantee that interference will not occur in a particular installation. If this equipment does cause harmful interference to radio or television reception, which can be determined by turning the equipment off and on, the user is encouraged to try to correct the interference by one or more of the following measures:

- Reorient or relocate the receiving antenna.
- Increase the separation between the equipment and receiver.
- Connect the equipment into an outlet on a circuit different from that to which the receiver is connected.
- Consult the dealer or an experienced radio/TV technician for help.

This equipment should be installed and operated with a minimum distance 20cm between the radiator and your body.

#### FCC Conditions

This device complies with part 15 of the FCC Rules. Operation is subject to the following two conditions:

- This device may not cause harmful interference.
- This device must accept any interference received, including interference that may cause undesired operation.

### EU Conformity Statement



This product and - if applicable - the supplied accessories too are marked with "CE" and comply therefore with the applicable harmonized European standards listed under the RE Directive 2014/53/EU, the EMC Directive 2014/30/EU, LVD Directive 2014/35/EU, the RoHS Directive 2011/65/EU. For the RED Directive 2014/53/EU, the frequency, mode and the maximum transmitted power are listed below:

EU:

## Wireless Bridge Quick Start Guide

---

Model	Received frequency	Transmitted frequency	Bandwidth	Frequency power
DS-3WF Series	5180 to 5240 MHz	5180 to 5240 MHz	20 MHz, 40 MHz and 80 MHz	802.11ac: 23 dBm
	5260 to 5320 MHz	5260 to 5320 MHz		802.11ac: 23 dBm
	5500 to 5700 MHz	5500 to 5700 MHz		802.11ac: 30 dBm

US:

Model	Received frequency	Transmitted frequency	Bandwidth	Frequency power
DS-3WF Series	5180 to 5240 MHz	5180 to 5240 MHz	20 MHz, 40 MHz and 80 MHz	802.11ac: 17 dBm
	5260 to 5320 MHz	5260 to 5320 MHz		802.11ac: 24 dBm
	5500 to 5700 MHz	5500 to 5700 MHz		802.11ac: 24 dBm
	5745 to 5825 MHz	5745 to 5825 MHz		802.11ac: 30 dBm



2012/19/EU (WEEE directive): Products marked with this symbol cannot be disposed of as unsorted municipal waste in the European Union. For proper recycling, return this product to your local supplier upon the purchase of equivalent new equipment, or dispose of it at designated collection points. For more information see: <http://www.recyclethis.info>.



2006/66/EC (battery directive): This product contains a battery that cannot be disposed of as unsorted municipal waste in the European Union. See the product documentation for specific battery information. The battery is marked with this symbol, which may include lettering to indicate cadmium (Cd), lead (Pb), or mercury (Hg). For proper recycling, return the battery to your supplier or to a designated collection point. For more information see: <http://www.recyclethis.info>.

### Industry Canada ICES-003 Compliance

This device meets the CAN ICES-3 (B)/NMB-3(B) standards requirements.

This device complies with Industry Canada licence-exempt RSS standard(s). Operation is subject to the following two conditions:

## Wireless Bridge Quick Start Guide

---

1. this device may not cause interference, and
2. this device must accept any interference, including interference that may cause undesired operation of the device.

Le présent appareil est conforme aux CNR d'Industrie Canada applicables aux appareils radioexempts de licence. L'exploitation est autorisée aux deux conditions suivantes :

1. l'appareil ne doit pas produire de brouillage, et
2. l'utilisateur de l'appareil doit accepter tout brouillage radioélectrique subi, même si le brouillage est susceptible d'en compromettre le fonctionnement.

Under Industry Canada regulations, this radio transmitter may only operate using an antenna of a type and maximum (or lesser) gain approved for the transmitter by Industry Canada. To reduce potential radio interference to other users, the antenna type and its gain should be so chosen that the equivalent isotropically radiated power (e.i.r.p.) is not more than that necessary for successful communication.

Conformément à la réglementation d'Industrie Canada, le présent émetteur radio peut fonctionner avec une antenne d'un type et d'un gain maximal (ou inférieur) approuvé pour l'émetteur par Industrie Canada. Dans le but de réduire les risques de brouillage radioélectrique à l'intention des autres utilisateurs, il faut choisir le type d'antenne et son gain de sorte que la puissance isotrope rayonnée équivalente (p.i.r.e.) ne dépasse pas l'intensité nécessaire à l'établissement d'une communication satisfaisante.

This equipment should be installed and operated with a minimum distance 20cm between the radiator and your body.

Cet équipement doit être installé et utilisé à une distance minimale de 20 cm entre le radiateur et votre corps.



## Preface

### Applicable Models

This manual is applicable to the DS-3WF Series wireless bridge.

### Symbol Conventions

The symbols that may be found in this document are defined as follows.

Symbol	Description
 <b>Danger</b>	Indicates a hazardous situation which, if not avoided, will or could result in death or serious injury.
 <b>Caution</b>	Indicates a potentially hazardous situation which, if not avoided, could result in equipment damage, data loss, performance degradation, or unexpected results.
 <b>Note</b>	Provides additional information to emphasize or supplement important points of the main text.

### Safety Instructions

#### **Caution**

- This is a class A product and may cause radio interference in which case the user may be required to take adequate measures.
- No naked flame sources, such as lighted candles, should be placed on the equipment.
- The serial port of the equipment is used for debugging only.
- Install the equipment according to the instructions in this manual.
- To prevent injury, this equipment must be securely attached to the floor/wall in accordance with the installation instructions.
- Keep vertical downward when moving or using the equipment.

#### **Warning**

- In the use of the product, you must be in strict compliance with the electrical safety regulations of the nation and region.
- The socket-outlet shall be installed near the equipment and shall be easily accessible.

## Wireless Bridge Quick Start Guide

---

- Do not connect several devices to one power adapter as adapter overload may cause overheating or a fire hazard.
- Please make sure that the plug is firmly connected to the power socket.



# Contents

<b>Chapter 1 Introduction .....</b>	<b>1</b>
1.1 Interface/Button .....	1
1.2 SSID .....	2
1.3 Indicator .....	2
1.4 Packing List .....	3
<b>Chapter 2 Installation .....</b>	<b>5</b>
2.1 Preparations for Installation .....	5
2.2 Pole Mounting .....	5
2.3 Wall Mounting .....	7
2.4 Connection and Power On .....	8
2.4.1 AP Connection .....	9
2.4.2 CPE Connection .....	9
<b>Chapter 3 Activation and Login .....</b>	<b>11</b>
3.1 Activation Using Web Browser .....	11
3.2 Activation Using iVMS 4200 .....	11
<b>Chapter 4 Get More Information .....</b>	<b>12</b>

# Chapter 1 Introduction

The 5 GHz gigabit wireless bridge (hereinafter referred to as the device) is used for long-distance wireless connection, which is suited for outdoor video security and transmission between sites in a LAN. The device supports 16 SSIDs, point-to-point as well as point-to-multipoint transmission.

## 1.1 Interface/Button

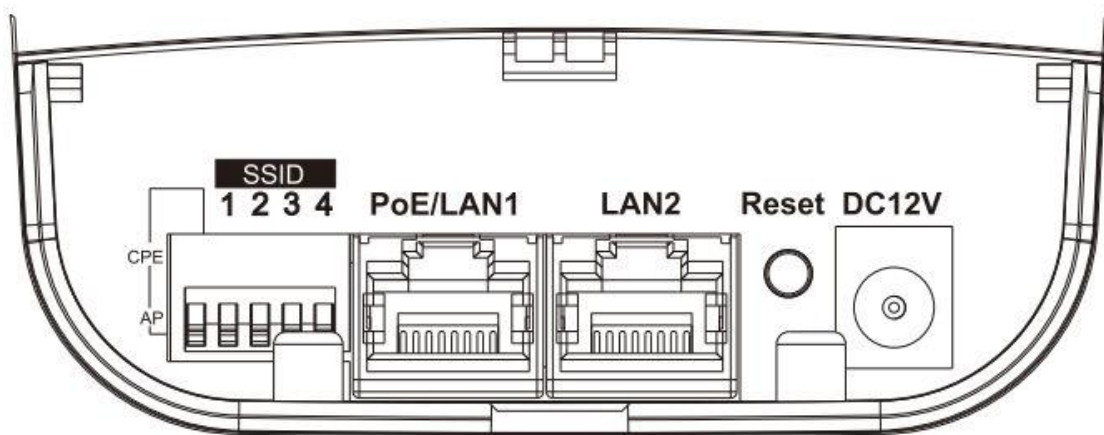



Figure 1-1 Interface/Button of Wireless Bridge

Table 1-1 Interface/Button Description

Interface/Button	Description
CPE/AP DIP Switch	Switch up or down to set the device as AP or CPE.
SSID	4-character SSID to realize 16 kinds of matching ways by switching up or down. The CPE will connect to the AP when its SSID matches the AP's.   <b>Note</b> The AP's SSID should be unique.
PoE/LAN 1	The 10/100/1000 Mbps adaptive RJ45 port, also can be used as a PoE port.
LAN 2	The 10/100/1000 Mbps adaptive RJ45 port.
Reset	Long press for 4 sec to restore to factory settings.
DC 12V	If the PoE injector is not used for powering on the device, you can use the attached power adapter to connect the device to socket.



## 1.2 SSID

4-character SSID can realize 16 kinds of matching ways by switching the DIP up or down.

 **Note**

Please switch the CPE/AP DIP to set what the device is used as before setting the SSID.

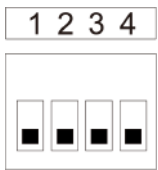
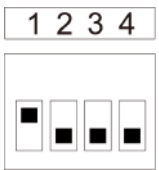
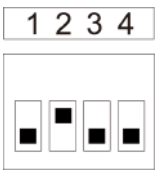
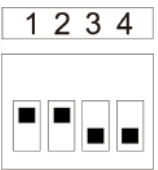
**Table 1-2 SSID No. Introduction**

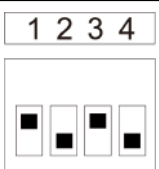
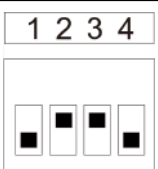
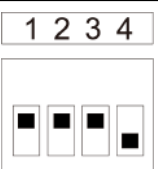
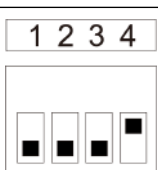
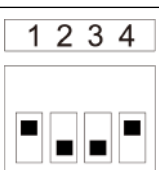
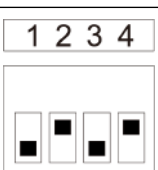
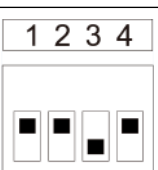
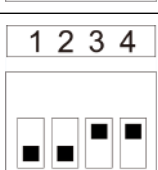
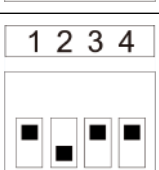
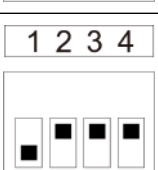
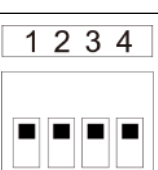
No.	DIP	No.	DIP	No.	DIP	No.	DIP
1		2		3		4	
5		6		7		8	
9		10		11		12	
13		14		15		16	

## 1.3 Indicator

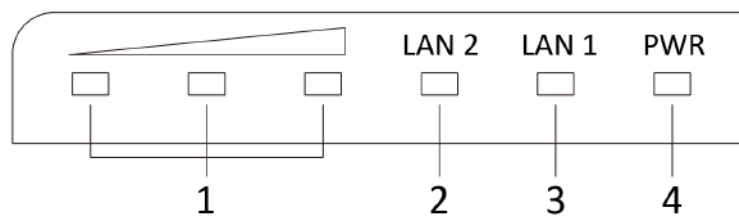

**Figure 1-2 Indicator**

**Table 1-3 Indicator Description**

No.	Indicator	Description	
1	Signal Strength Indicator	Solid	The devices are matched. <ul style="list-style-type: none"><li>• Solid red, yellow and green: <math>RSSI \geq -60</math>, the wireless signal is strong.</li><li>• Solid red and yellow, unlit green: <math>-75 \leq RSSI &lt; -60</math>, the wireless signal is normal.</li><li>• Solid red, unlit yellow and green: <math>RSSI &lt; -75</math>, the wireless signal is weak. Please adjust the position and direction of the device.</li></ul>
		Unlit	The devices are not matched.
2/3	LAN 1/LAN 2 Indicator	Solid Green	The port is connected.
		Flashing Green	The port is transmitting data. The faster the indicator flashes, the greater the transmission rate is.
		Unlit	The port is disconnected or connection is abnormal.
4	Power Indicator	Solid Green	The device is powered on normally.
		Unlit	No power supply connected or power supply is abnormal.

### 1.4 Packing List

Please check if there is any damage of the package first. According to the packing list, make sure no item is lost. After confirming, you can continue to install the device.

# Wireless Bridge Quick Start Guide

---

**Table 1-4 Packing List**

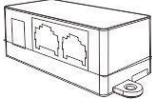
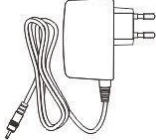
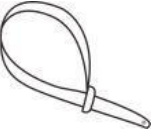
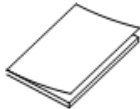
Item	Quantity	Item	Quantity	Item	Quantity
	Wireless Bridge × 1		PoE Injector × 1		Power Adapter × 1
	Cable Tie × 2		Quick Start Guide × 1	--	--

## Chapter 2 Installation

### 2.1 Preparations for Installation

To avoid device damage or personal injury caused by improper useage of the device, please follow the preparations below.

- Use the attached power adapter and PoE injector to power the device.
- The distance between AP and CPE should be less than the suggested figure to secure transmission rate.
- Make sure the device is installed vertically in forward direction, while not horizontally or in reverse direction.
- Make sure the water-proof cover is on.
- Protect the power adapter and PoE injector from rain. It is suggested to put them into a water-proof case or the dry place.
- It is suggested to manage the gap between cover and device with fluid dispensing.
- Install the device in the place where the maintenance personnel can operate.
- The devices should be installed face to face and the max. angle of deviation is 30° .
- Disconnect the power source during servicing.
- The temperature of the cover area will be high when device working. Only installation and maintenance personnel can operate.

### 2.2 Pole Mounting

#### Before You Start

Mount the device on the pole with a diameter of 40 to 100 mm using the attached cable tie.

#### Steps

1. Thread the cable ties into the installtion holes at the back of the device.

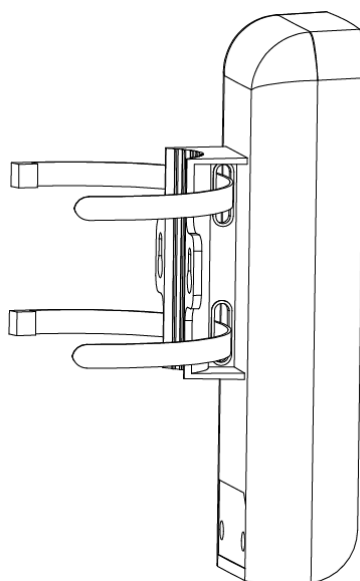

**Figure 2-1 Thread Cable Ties**

2. Fix and fasten the cable ties on the pole.

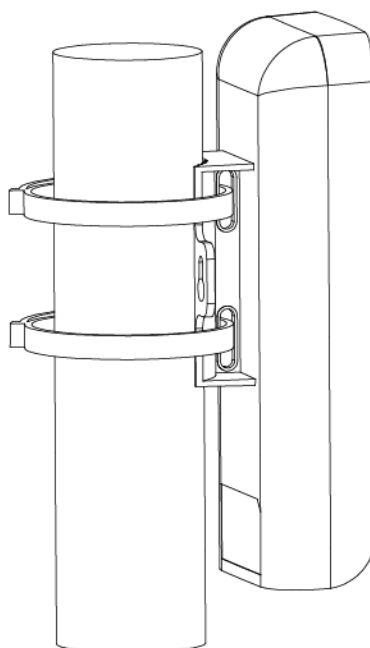

**Figure 2-2 Pole Mounting Finished**

---

 **Note**

Adjust the direction of the device manually to keep it vertical in forward direction.

---

## 2.3 Wall Mounting

Mount the device on a flat and stable wall with 2 M4 expansion bolts.

### Steps



It is easy to take down the device for wall mounting. Please mount with caution.

---

1. Drill two parallel holes, about 54.5 mm apart.
2. Insert the bolts into the pre-drilled hole, leaving 5 mm length out of the wall.

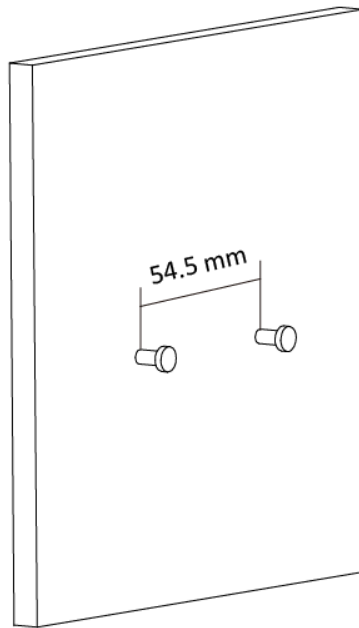

**Figure 2-3 Expansion Bolt Position**

3. Align the bigger round hole of the hanging hole with the bolts, and hang the device on the bolts.



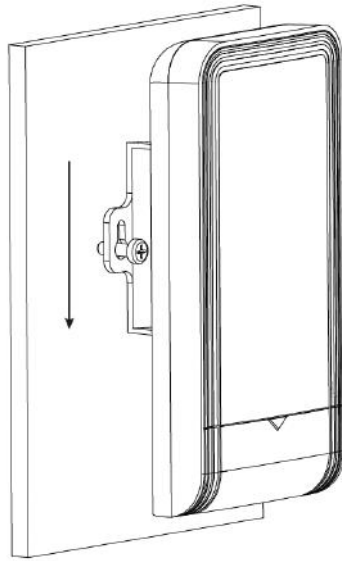

**Figure 2-4 Hang the Device**

4. Make sure the device is mounted stably and vertically in forward direction.

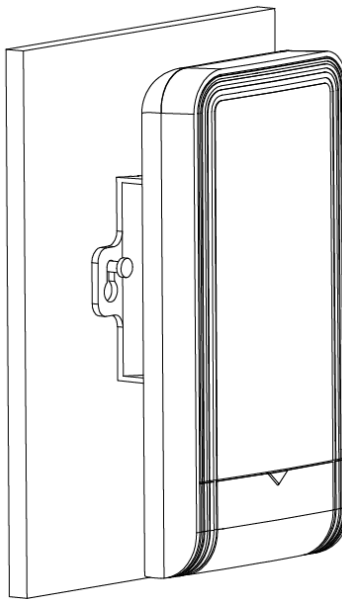

**Figure 2-5 Wall Mounting Finished**

## 2.4 Connection and Power On

Use the attached power adapter and PoE injector to power on the device.

## 2.4.1 AP Connection

### Steps

1. Switch the CPE/AP DIP to set the device as AP.
2. Select an SSID No.

### Example

SSID No. 1 (All Down).

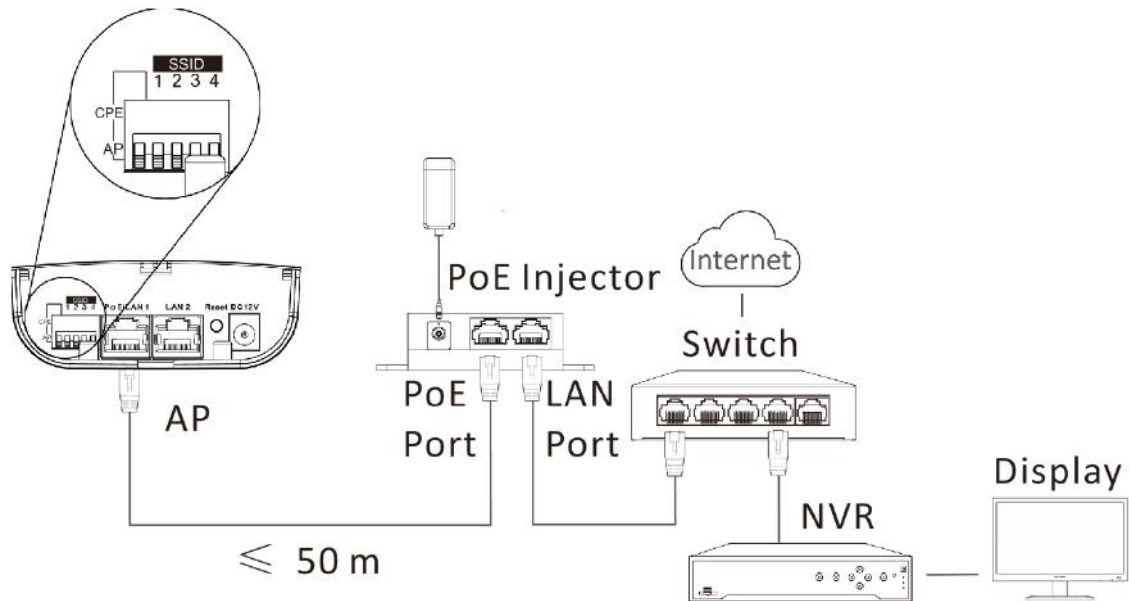

Figure 2-6 AP Connection



### Note

- See **Table 1-2** for detailed information about SSID No.
  - The PoE injector must be connected to an earthed mains socket-outlet.
- 

## 2.4.2 CPE Connection

### Steps

1. Switch the CPE/AP DIP to set the device as CPE.
2. Select the SSID No. set on the AP to match.

### Example

SSID No. 1 (All Down).

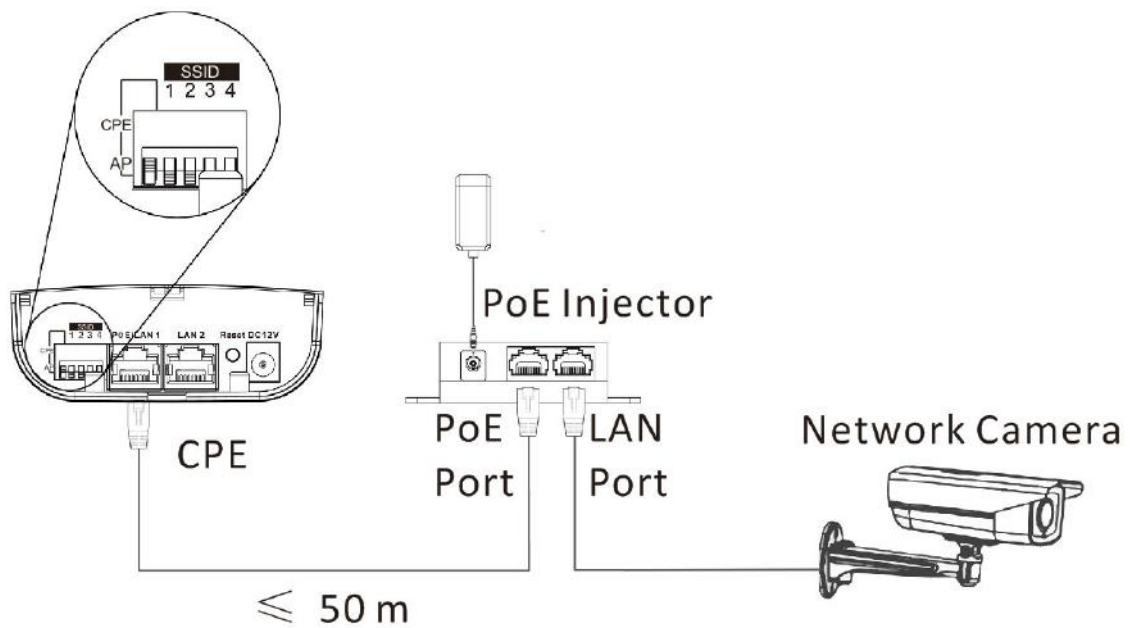

**Figure 2-7 CPE Connection**

- 3. Optional:** If there are more than one CPE (no more than 4) to be matched with one AP, repeat the previous steps connect and set the CPEs.

### What to do next

#### Note

- See **Indicator** for details after connection to check device powering, network connection and signal strength.
  - The SSIDs of APs in the same direction cannot be the same to avoid matching failure.
  - The PoE injector must be connected to an earthed mains socket-outlet.
-

## Chapter 3 Activation and Login

You can manage the device using the iVMS 4200 software or the Web browser. Before managing the device, you need to activate and log in to the device first.

---

 **Note**

- Make sure the device is powered on and connected to the network correctly.
  - Make sure the device is in the same network segment with the PC.
- 

 **Caution**

The password strength of the device can be automatically checked. We highly recommend you change the password of your own choosing (using a minimum of 8 characters, including at least three kinds of following categories: upper case letters, lower case letters, numbers, and special characters) in order to increase the security of your product. And we recommend you change your password regularly, especially in the high security system, changing the password monthly or weekly can better protect your product.

Proper configuration of all passwords and other security settings is the responsibility of the installer and/or end-user.

---

### 3.1 Activation Using Web Browser

#### Steps

1. Enter **192.168.1.36** in the web browser.
2. Set **Password**.
3. Read and agree with the disclaimer and select **Country/Region Code**.
4. Click **OK** to finish activation.

### 3.2 Activation Using iVMS 4200

#### Steps

1. Download and install the latest iVMS 4200 software from the official website.
2. Select the inactive device and click **Activate** in **Online Device**.
3. Create a password in the password field, and confirm the password.
4. Click **OK** to activate the device.
5. Click **Add**, set **Name**, **IP Address** and **Password** to add the device to the client.
6. Read and agree with the disclaimer and select **Country/Region Code**.
7. Click **OK** to finish activation.

## Chapter 4 Get More Information

You can manage the device using the iVMS-4200 software or the Web browser.

- Scan the QR code below for iVMS-4200 software operations.



- Scan the QR code below for Web browser operations.





See Far, Go Further